



Agilent X-Series Signal Analyzer

**This manual provides documentation for the
for the following analyzers:**

**PXA Signal Analyzer N9030A
MXA Signal Analyzer N9020A
EXA Signal Analyzer N9010A
CXA Signal Analyzer N9000A**

**N9080A/W9080A LTE
Measurement Application
User's and Programmer's
Reference**



Agilent Technologies

Notices

© Agilent Technologies, Inc. 2008 - 2012

No part of this manual may be reproduced in any form or by any means (including electronic storage and retrieval or translation into a foreign language) without prior agreement and written consent from Agilent Technologies, Inc. as governed by United States and international copyright laws.

Trademark Acknowledgements

Microsoft[®] is a U.S. registered trademark of Microsoft Corporation.

Windows[®] and MS Windows[®] are U.S. registered trademarks of Microsoft Corporation.

Adobe Reader[®] is a U.S. registered trademark of Adobe System Incorporated.

Java[™] is a U.S. trademark of Sun Microsystems, Inc.

MATLAB[®] is a U.S. registered trademark of Math Works, Inc.

Norton Ghost[™] is a U.S. trademark of Symantec Corporation.

Manual Part Number

N9080-90005

Print Date

February 2012

Printed in USA

Agilent Technologies, Inc.
1400 Fountaingrove Parkway
Santa Rosa, CA 95403

Warranty

The material contained in this document is provided “as is,” and is subject to being changed, without notice, in future editions. Further, to the maximum extent permitted by applicable law, Agilent disclaims all warranties, either express or implied, with regard to this manual and any information contained herein, including but not limited to the implied warranties of merchantability and fitness for a particular purpose. Agilent shall not be liable for errors or for incidental or consequential damages in connection with the furnishing, use, or performance of this document or of any information contained herein. Should Agilent and the user have a separate written agreement with warranty terms covering the material in this document that conflict with these terms, the warranty terms in the separate agreement shall control.

Technology Licenses

The hardware and/or software described in this document are furnished under a license and may be used or copied only in accordance with the terms of such license.

Restricted Rights Legend

If software is for use in the performance of a U.S. Government prime contract or subcontract, Software is delivered and

licensed as “Commercial computer software” as defined in DFAR 252.227-7014 (June 1995), or as a “commercial item” as defined in FAR 2.101(a) or as “Restricted computer software” as defined in FAR 52.227-19 (June 1987) or any equivalent agency regulation or contract clause. Use, duplication or disclosure of Software is subject to Agilent Technologies’ standard commercial license terms, and non-DOD Departments and Agencies of the U.S. Government will receive no greater than Restricted Rights as defined in FAR 52.227-19(c)(1-2) (June 1987). U.S. Government users will receive no greater than Limited Rights as defined in FAR 52.227-14 (June 1987) or DFAR 252.227-7015 (b)(2) (November 1995), as applicable in any technical data.

Safety Notices

CAUTION

A **CAUTION** notice denotes a hazard. It calls attention to an operating procedure, practice, or the like that, if not correctly performed or adhered to, could result in damage to the product or loss of important data. Do not proceed beyond a **CAUTION** notice until the indicated conditions are fully understood and met.

WARNING

A **WARNING** notice denotes a hazard. It calls attention to an operating procedure, practice, or the like that, if not correctly performed or adhered to, could result in personal injury or death. Do not proceed beyond a **WARNING** notice until the indicated conditions are fully understood and met.

Warranty

This Agilent technologies instrument product is warranted against defects in material and workmanship for a period of one year from the date of shipment. during the warranty period, Agilent Technologies will, at its option, either repair or replace products that prove to be defective.

For warranty service or repair, this product must be returned to a service facility designated by Agilent Technologies. Buyer shall prepay shipping charges to Agilent Technologies shall pay shipping charges to return the product to Buyer. However, Buyer shall pay all shipping charges, duties, and taxes for products returned to Agilent Technologies from another country.

Where to Find the Latest Information

Documentation is updated periodically. For the latest information about this analyzer, including firmware upgrades, application information, and product information, see the following URLs:

<http://www.agilent.com/find/pxa>

<http://www.agilent.com/find/mxa>

<http://www.agilent.com/find/exa>

<http://www.agilent.com/find/cxa>

To receive the latest updates by email, subscribe to Agilent Email Updates:

<http://www.agilent.com/find/emailupdates>

Information on preventing analyzer damage can be found at:

<http://www.agilent.com/find/tips>

Is your product software up-to-date?

Periodically, Agilent releases software updates to fix known defects and incorporate product enhancements. To search for software updates for your product, go to the Agilent Technical Support website at www.agilent.com/find/techsupport.

1. Using Help

How Help is Organized.....	124
Front Panel Keys used by the Help System	127
Navigating the Help Files	128
Basic Help Window Operations	129
Navigating Help with a Mouse	130
Navigating Help Without a Mouse	131
Definition of Terms.....	136
Viewing Help Files on a separate Computer.....	138
Other Help Resources.....	140

2. About the Analyzer

Installing Application Software	144
Viewing a License Key	144
Obtaining and Installing a License Key	144
Missing and Old Measurement Application Software	145
X-Series Options and Accessories	146
Front-Panel Features.....	147
Overview of key types.....	151
Display Annotations	154
Rear-Panel Features	156
Window Control Keys	160
Multi-Window.....	160
Zoom.....	160
Next Window	161
Mouse and Keyboard Control.....	163
Right-Click	163
PC Keyboard.....	164
Instrument Security & Memory Volatility	168

3. About the N9080A LTE Measurement Application

What Does the Agilent N9080A LTE Measurement Application Do?.....	170
---	-----

4. Programming the Analyzer

What Programming Information is Available?.....	172
IEEE Common GPIB Commands.....	173
Calibration Query	173
Clear Status	173
Standard Event Status Enable	173
Standard Event Status Register Query	174
Identification Query	174
Instrument Model Number	175
Operation Complete	175
Query Instrument Options	176
Recall Instrument State	176
Save Instrument State	177
Service Request Enable	177
Status Byte Query	178

Contents

Trigger	178
Self Test Query	178
Wait-to-Continue	178

5. System Functions

File	182
File Explorer	182
Page Setup	183
Print	184
Maximize/Restore Down	184
Maximize	184
Restore Down	184
Minimize	185
Exit	185
Mode Preset	186
Restore Mode Defaults	188
Meas Preset	189
Preset Type (Remote Command Only)	189
*RST (Remote Command Only)	189
Print	191
Quick Save	192
Recall	194
State	194
Register 1 thru Register 6	195
From File\ File Open	196
Data (Import)	198
Import Trace Data	199
Signal Studio Setup	199
Vector Signal Analyzer Setup	200
Masks	200
EVM Setup	202
Open...	203
File Open Dialog and Menu	203
Open	203
File/Folder List	204
Sort	204
Files Of Type	205
Up One Level	206
Cancel	206
Save	207
State	207
Register 1 thru Register 6	207
To File	209
Save As	209
Trace (+State)	210
Register 1 thru Register 5	211
From Trace	212
Save As	212
Data (Export)	213

Contents

Save As	214
Screen Image	215
Themes	217
Save As...	218
Save As	219
Save	219
File/Folder List	220
File Name	220
Save As Type	220
Up One Level	220
Create New Folder	221
Cancel	221
Mass Storage Catalog (Remote Command Only)	222
Mass Storage Change Directory (Remote Command Only)	222
Mass Storage Copy (Remote Command Only)	222
Mass Storage Delete (Remote Command Only)	223
Mass Storage Data (Remote Command Only)	223
Mass Storage Make Directory (Remote Command Only)	224
Mass Storage Move (Remote Command Only)	224
Mass Storage Remove Directory (Remote Command Only)	224
System	225
Show	225
Errors	225
System	229
Hardware	230
LXI	231
Power On	234
Mode and Input/Output Defaults	235
User Preset	235
Last State	236
Power On Application	237
Configure Applications	237
Configure Applications - Instrument boot-up	240
Configure Applications - Windows desktop	241
Configure Applications - Remote Commands	241
Restore Power On Defaults	243
Alignments	243
Auto Align	243
Align Now	250
Show Alignment Statistics	255
Restore Align Defaults	260
Backup or Restore Align Data...	261
Advanced	268
Timebase DAC	270
RF Preselector	271
Restore Defaults	280
Restore Input/Output Defaults	280
Restore Power On Defaults	281
Restore Align Defaults	281

Contents

Restore Misc Defaults	282
Restore Mode Defaults (All Modes)	283
All	284
Control Panel	284
Licensing	285
Security	288
USB	288
Diagnostics	289
RF Preselector	289
Show Hardware Statistics	289
Advanced	292
Service	293
Internet Explorer	293
System Remote Commands (Remote Commands Only)	293
System Powerdown (Remote Command Only)	293
List installed Options (Remote Command Only)	293
Lock the Front-panel keys (Remote Command Only)	294
List SCPI Commands (Remote Command Only)	294
SCPI Version Query (Remote Command Only)	294
Date (Remote Command Only)	295
Time (Remote Command Only)	295
I/O Config	296
GPIB	296
SCPI LAN	297
Reset Web Password	300
LXI	300
System IDN Response	308
Query USB Connection (Remote Command Only)	310
USB Connection Status (Remote Command Only)	310
USB Packet Count (Remote Command Only)	311
User Preset	312
User Preset	312
User Preset All Modes	313
Save User Preset	314
6. Channel Power Measurement	
AMPTD Y Scale	321
Ref Value	321
Attenuation	322
Range	322
Scale/Div	322
Presel Center	323
Presel Adjust	323
Y Axis Unit	323
Reference Level Offset	323
μ W Path Control	324
Internal Preamp	324
Ref Position	324
Auto Scaling	325

Contents

Auto Couple	326
BW	327
Res BW	327
Video BW	328
Filter Type	330
Cont.	332
FREQ Channel	333
Input/Output	334
Marker	335
Select Marker	335
Marker Type	335
Marker X Axis Value (Remote Command Only)	336
Marker X Axis Position (Remote Command Only)	336
Marker Y Axis Value (Remote Command only)	337
Properties	337
Select Marker	338
Relative To	338
Marker Trace (DVB-T/H and DTMB (CTTB) only)	338
Marker Trace(ISDB-T and CMMB only)	339
Couple Markers	339
All Markers Off	340
Backward Compatibility SCPI Commands	340
Marker Function	342
Marker To	343
Meas	344
Meas Setup	345
Avg/Hold Num	345
Avg Mode	346
Integ BW	347
Carrier Results (Only for MSR)	348
PhNoise Opt	349
PhNoise Opt Auto	349
PhNoise Opt State	350
IF Gain	350
IF Gain Auto	350
IF Gain State	351
Method	352
Filter Alpha	352
Filter BW	353
Limits	354
Power Limit	355
Power Limit Fail (remote command only)	356
PSD Limit	356
PSD Limit Fail (remote command only)	357
PSD Unit	358
Meas Preset	358
Shoulder Offset Start (Only for DVB-T/H and ISDB-T mode)	358
Shoulder Offset Stop (Only for DVB-T/H and ISDB-T mode)	359
Shoulder Offset (Only for DTMB (CTTB) and CMMB mode)	360

Mode	361
Mode Setup	362
Peak Search	363
Recall	364
Restart	365
Save	366
Single	367
Source	368
Span X Scale	369
Span	369
Full Span	370
Last Span	371
Sweep/Control	372
Sweep Time	372
Sweep Setup	373
Auto Sweep Time Rules	373
Pause	374
Gate	374
Points	374
Trace/Detector	376
Trace Type	376
Detector	376
Detector Selection	377
Auto	378
Trigger	379
View/Display	380
Display	383
Power Results (Only for MSR)	383
Carrier Info (Only for MSR)	385
Carrier Freq (Only for MSR)	386
Bar Graph	386
RF Spectrum (Only for DVB-T/H, DTMB (CTTB), ISDB-T and CMMB)	387
Shoulder Attenuation (Only for DVB-T/H, DTMB (CTTB), ISDB-T and CMMB)	389
Spectrum Mask(DTMB (CTTB), DVB-T/H only)	393
Mask - selection by Enum (Only for DVB-T/H mode)	395
Limit Mask (DTMB (CTTB), DVB-T/H only)	396
Scroll	396

7. Occupied Bandwidth Measurement

AMPTD Y Scale (Amplitude/Y Scale)	401
Ref Value	401
Attenuation	402
Scale/Div	402
Presel Center	403
Presel Adjust	403
Y Axis Unit	403
Reference Level Offset	403
μW Path Control	403
Internal Preamp	404

Contents

Ref Position	404
Auto Scaling	405
Auto Couple	406
BW	407
Res BW	407
Video BW	408
Filter Type	410
Cont (Continuous)	411
FREQ/Channel (Frequency or Channel)	412
Input/Output	413
Marker	414
Select Marker	414
Marker X Axis Value (Remote Command Only)	414
Marker X Axis Position (Remote Command Only)	415
Marker Y Axis Value (Remote Command Only)	415
Marker Type	416
Properties	416
Select Marker	417
Relative To	417
All Markers Off	418
Backward Compatibility SCPI Commands	418
Marker Function	419
Marker To	420
Meas	421
Meas Setup	422
Avg/Hold Num	422
Avg Mode	423
Max Hold (Remote Command Only)	423
Occ BW % Pwr	424
x dB	425
IF Gain	426
IF Gain Auto	426
IF Gain State	426
Limit (for all modes except MSR)	427
Limit (for MSR mode)	429
Limit Test	429
Bandwidth	429
Meas Preset	430
Mode	431
Mode Setup	432
Peak Search	433
Recall	434
Restart	435
Save	436
Single	437
Source	438
Span X Scale	439
Span	439
Full Span	440

Contents

Last Span	441
Sweep/Control	442
Sweep Time	442
Sweep Setup	443
Auto Sweep Time Rules	443
Pause	444
Gate	444
Points	444
Trace/Detector	446
Trace Type	446
Detector	447
Detector Selection	447
Auto	448
Trigger	450
View/Display	451
Display	455

8. ACP Measurement

AMPTD Y Scale	470
Ref Value	470
Attenuation	470
Scale/Div	471
Presel Center	471
Presel Adjust	472
Y Axis Unit	472
Reference Level Offset	472
μ W Path Control	472
Internal Preamp	472
Ref Position	473
Auto Scaling	473
Auto Couple	475
BW	476
Res BW	476
Video BW	477
RBW Control	479
Filter Type	479
Filter BW	480
Cont	481
FREQ Channel	482
Input/Output	483
Marker	484
Select Marker	484
Marker Type	484
Marker X Axis Value (Remote Command only)	485
Marker X Axis Position (Remote Command only)	486
Marker Y Axis Value (Remote Command only)	487
Properties	487
Select Marker	487
Relative To	487

Contents

Marker Trace	488
Couple Markers	489
Marker All Off	490
Backward Compatibility Remote Commands	490
Marker Function	491
Marker To	492
Meas	493
Meas Setup	494
Average/Hold Number	494
Avg Mode	495
Carrier Setup (This menu is unavailable in MSR)	495
Carriers	495
Ref Carrier	496
Ref Car Freq	497
Power Ref	498
Configure Carriers	500
Power Ref (MSR Only)	508
Carrier Index	508
Manual	509
Offset/Limits	510
Select Offset	510
Offset Freq	510
Integ BW	513
Offset BW	515
Limits	520
Offset Side	528
Method for Offset	529
Offset Frequency Define	531
Carrier Result	532
PhNoise Opt	532
PhNoise Opt Auto	533
PhNoise Opt State	533
Meas Method	534
Meas Type	536
PSD Ref	536
Limit Test	537
Noise Correction	538
Meas Preset	539
Offset RRC Weighting (Backward Compatibility SCPI)	539
Offset Filter Alpha (Backward Compatibility SCPI)	540
Method for Carrier (Backward Compatibility SCPI)	541
Mode	543
Mode Setup	544
Peak Search	545
Peak Search	545
Next Peak	545
Next Pk Right	545
Next Pk Left	546
Marker Delta	546

Pk-Pk Search.....	546
Min Search.....	547
Recall.....	548
Restart.....	549
Save.....	550
Single.....	551
Source.....	552
SPAN X Scale.....	553
Span.....	553
Full Span.....	554
Last Span.....	555
Sweep/Control.....	556
Sweep Time.....	556
Sweep Setup.....	558
Auto Sweep Time Rules.....	558
Pause.....	558
Gate.....	559
Points.....	559
Trace/Detector.....	561
Select Trace (Front-panel Only).....	561
Trace Type.....	561
View / Blank.....	562
Detector.....	563
Auto.....	564
Detector Selection.....	565
Trigger.....	567
View/Display.....	568
Display.....	573
Result Trace (MSR Only).....	573
Carrier Info (MSR Only).....	574
Carrier Freq (MSR Only).....	575
Bar Graph.....	576

9. Power Stat CCDF Measurement

AMPTD Y Scale.....	580
Attenuation.....	580
Range.....	580
Presel Center.....	580
Presel Adjust.....	580
Y Axis Unit.....	581
Reference Level Offset.....	581
μ W Path Control.....	581
Internal Preamp.....	581
Auto Couple.....	582
BW.....	583
Info BW.....	583
Cont.....	585
FREQ Channel.....	586
Input/Output.....	587

Contents

Marker	588
Select Marker	588
Marker Type	588
Marker X Axis Value (Remote Command Only)	589
Marker Y Axis Value (Remote Command Only)	590
Properties	590
Select Marker	590
Relative To	591
Marker Trace	591
Couple Markers	592
All Markers Off	592
Marker Function	593
Marker To	594
Meas	595
Meas Setup	596
Counts	596
Meas Cycles	596
Meas Interval (When the application is NOT CDMA1xEVDO)	597
Meas Interval (CDMA1xEVDO Only)	598
Meas Offset (CDMA1xEVDO Only)	599
IF Gain	599
IF Gain Auto	599
IF Gain State	600
Meas Preset	601
Mode	602
Mode Setup	603
Peak Search	604
Recall	605
Restart	606
Save	607
Single	608
Source	609
Span X Scale	610
Scale/Div	610
Sweep/Control	611
Pause/Resume	611
Trace/Detector	612
Store Ref Trace	612
Ref Trace	612
Gaussian Line	613
Trigger	614
View/Display	615
Display	619
Slot View (TD-SCDMA only)	619
10. Spurious Emissions Measurement	
AMPTD Y Scale	623
Ref Value	623
Attenuation	624

Scale/Div.	624
Presel Center	624
Presel Adjust	625
Y Axis Unit	625
Ref Lvl Offset	625
μ W Path Control	625
Internal Preamp.	625
Auto Scaling	626
Auto Couple	627
BW	628
Cont	629
Frequency/Channel	630
Input/Output	631
Marker	632
Select Marker	632
Marker Type	632
Marker X Axis Value (Remote Command only)	633
Marker X Axis Position (Remote Command only)	634
Marker Y Axis Value (Remote Command only)	634
Properties	635
Select Marker	635
Relative To	635
Couple Markers.	636
All Markers Off.	637
Marker Function	638
Marker To	639
Meas	640
Meas Setup	641
Avg/Hold Num	641
Avg Mode	642
Range Table	642
Range	643
Start Freq.	644
Stop Freq.	646
Res BW	648
Video BW	650
Filter Type	651
Abs Start Limit	652
Abs Stop Limit	654
Peak Excursion	656
Pk Threshold.	657
Attenuation	657
Detector 1	658
Detector 2	659
Sweep Time.	660
Points	661
IF Gain	663
Meas Type.	664
Spur.	665

Spurious Report Mode	666
Fast Spurious Meas (Remote Command only)	666
Meas Preset	667
Range Preset (TD-SCDMA only)	667
Category A (TD-SCDMA only)	667
Category B (TD-SCDMA only)	668
Mobile (TD-SCDMA only)	669
Frequency Setup (TD-SCDMA only)	670
CH Mean Power (DVB-T/H only)	674
Mode	676
Mode Setup	677
Peak Search	678
Next Peak	678
Next Pk Right	678
Next Pk Left	679
Marker Delta	679
Pk-Pk Search	679
Min Search	680
Recall	681
Restart	682
Save	683
Single	684
Source	685
Span X Scale	686
Sweep/Control	687
Sweep Setup	687
Auto Sweep Time Rules	687
Pause	688
Gate	688
Trace/Detector	689
Trigger	690
View/Display	691
Display	691
View Selection	691
Range Table Selection (SCPI only command)	694

11. Spectrum Emission Mask Measurement

AMPTD Y Scale	726
Ref Value	726
Attenuation	727
Scale/Div	727
Presel Center	727
Presel Adjust	727
Y Axis Unit	728
Reference Level Offset	728
mW Path Control	728
Internal Preamp	728
Ref Position	728
Auto Scaling	729

Contents

Auto Couple	731
BW	732
Filter Type	732
Cont	733
FREQ Channel	734
Input/Output	735
Marker	736
Select Marker	736
Marker Type	736
Marker X Axis Value (Remote Command Only)	737
Marker X Axis Position (Remote Command Only)	737
Marker Y Axis Value (Remote Command Only)	738
Couple Markers	739
All Markers Off	739
Marker Function	741
Marker To	742
Meas	743
Meas Setup	744
Avg/Hold Num	744
Meas Type	745
Ref Channel	745
Integ BW	746
Span	747
Sweep Time	748
Res BW	749
Video BW	751
VBW/RBW	752
Power Ref (for the modes except MSR)	754
Power Ref (Only for MSR)	756
Offsets/Limit	759
Select Offset	759
Start Freq	759
Stop Freq	762
Sweep Time	764
Offset Side	765
Res BW	765
Meas BW	767
Video BW	769
VBW/RBW	770
Limits	771
Method	783
Filter Alpha	783
Meas Preset	784
Limit State(Only for TD-SCDMA)	784
Limit Type (Only for DVB-T/H)	785
Limit Type (Only for ISDB-T)	786
JEITA	790
Offset Freq Define	792
Offset Freq Define (Only for MSR)	794

Mode	799
Mode Setup	800
Peak Search	801
Recall	802
Restart	803
Save	804
Single	805
Source	806
Span X Scale	807
Sweep/Control	808
Pause	808
Gate	808
Trace/Detector	809
Trace Type	809
Chan Detector	809
Chan Detector Selection	810
Chan Detector Auto	811
Offset Detector	811
Offset Detector Selection	812
Offset Detector Auto	812
Trigger	814
View/Display	815
Display	817
Abs Pwr Freq	817
Rel Pwr Freq	826
Integrated Power	832
Carrier Info (MSR Only)	838
Carrier Freq (MSR Only)	840
Limit Lines	841

12. LTE Modulation Analysis Measurement

AMPTD (Amplitude) Y Scale	849
Auto Couple	850
BW (Bandwidth)	851
Cont (Continuous)	852
FREQ Channel	853
Center Freq	853
Start Freq	853
Stop Freq	853
CF Step	854
Input/Output	855
Marker	856
Marker Function	857
Marker -> (Marker To)	858
Meas (Measure)	859
Meas Setup (Measurement Setup)	860
Avg Number	860
Average Mode	861
Average Setup	861

Sync/Format Setup (Downlink)	861
Sync Type	861
RS-PRS	863
Cell ID	864
Tx Antenna	865
MIMO Decoding	873
PDSCH Cell Specific Ratio	875
Sync/Format Setup (Uplink)	875
Sync Type (Uplink)	876
Half Subcarrier Shift	877
PUSCH DFT Swap	878
Meas Time Setup	879
Result Length	879
Meas Offset Slot	880
Meas Offset Symbol	880
Meas Interval Slot	881
Meas Interval Symbol	882
Analysis Start Boundary	882
Chan Profile Setup (Downlink)	884
Detection	884
RB Auto Detect Mode	885
Auto Detect Power Levels	886
Round to Standard Values	887
Number of Expected DL Users	887
Composite Include	888
Include P-SS	889
Include S-SS	890
Include PBCH	890
Include PCFICH	891
Include PHICH	891
Include RS	892
Include PDCCH	892
Include Non Allocation	893
Include Users (Downlink)	893
Edit Control Channels	897
Edit User Mapping (Downlink)	917
Copy Auto -> Manual	974
Chan Profile Setup (Uplink)	975
Detection	975
Auto Detect Power Levels	975
Include Non Allocation	976
Composite Include (Uplink)	976
Include Users (Uplink)	977
Edit User Mapping (Uplink)	985
Copy Auto -> Manual	1125
Decode	1125
Decode Type	1125
DCI Format Detection Include	1131
RNTI Range	1132

DCI Format 2 PMI Config	1136
PUSCH Decode Parameters	1138
PUCCH Decode Parameters	1143
ACK/NACK Feedback Mode	1146
Advanced	1146
Cyclic Prefix Length (Downlink)	1146
Cyclic Prefix Length (Uplink)	1148
Extended Freq Lock Range	1149
Equalizer Training	1150
Symbol Timing Adjust	1154
EVM Window Length	1157
Result Format	1159
Time Scale Factor	1163
Multi Carrier Filter	1164
Phase Noise Optimization	1164
EVM Minimization	1165
EVM Minimization Items	1166
Exclude EVM Transient Time	1168
Opposite Direction Active	1169
Antenna Element Spacing	1169
Meas Preset	1170
Mode	1171
Mode Setup	1172
Peak Search	1173
Recall	1174
Restart	1175
Save	1176
Single	1177
Source	1178
SPAN X Scale	1179
Span	1179
Full Span	1179
Sweep / Control	1180
Trace/Detector	1181
Data	1181
Pre Demod	1183
Statistical	1185
Demod	1186
Demod Err (Error)	1189
Tables	1193
Response	1202
MIMO	1204
ACP	1206
OBW	1206
Register	1206
No Data	1206
Trigger	1208
View/Display	1209
Display	1209

Layout	1209
Preset View	1210
Preset View: Basic	1210
Preset View: Meas Summary	1211
Preset View: RB Slot Meas.	1212
Preset View: Subcarrier Meas.	1213
Preset View: MIMO Summary	1214

13. Monitor Spectrum Measurement

AMPTD Y Scale	1218
Ref Value	1218
Attenuation	1218
Scale/Div	1219
Presel Center	1219
Presel Adjust	1219
μ W Path Control	1219
Internal Preamp	1219
Ref Position	1220
Auto Scaling	1220
Auto Couple	1222
BW	1223
Res BW	1223
Video BW	1225
VBW:3dB RBW	1227
Span:3dB RBW	1227
Cont	1229
FREQ Channel	1230
Input/Output	1231
Marker	1232
Select Marker	1232
Marker Type	1232
Marker X Axis Value (Remote Command only)	1233
Marker X Axis Position (Remote Command only)	1233
Marker Y Axis Value (Remote Command only)	1234
Properties	1234
Select Marker	1234
Relative To	1235
Marker Trace	1235
Couple Markers	1236
All Markers Off	1236
Marker Function	1237
Select Marker	1237
Marker Function Type	1237
Band Adjust	1237
Band/Interval Span for Frequency Domain	1238
Band/Interval Left for Frequency Domain	1238
Band/Interval Right for Frequency Domain	1239
Marker To	1240
Meas	1241

Meas Setup	1242
Avg/Hold Num	1242
Avg Mode	1242
Meas Preset	1243
Mode	1244
Mode Setup	1245
Peak Search	1246
Recall	1247
Restart	1248
Save	1249
Single	1250
Source	1251
Span X Scale	1252
Span	1252
Full Span	1253
Last Span	1253
Sweep/Control	1255
Sweep Time	1255
Pause	1255
Gate	1256
Points	1256
Trace/Detector	1257
Select Trace	1257
Trace Type	1257
Update	1258
Display	1258
Detector	1259
Auto	1260
Clear Trace	1260
Clear All Traces	1261
Trigger	1262
View/Display	1263
Display	1265
Result Trace (Only for MSR)	1265
Carrier Info (Only for MSR)	1266
Carrier Freq (Only for MSR)	1267
Carrier Attribute (Only for MSR)	1268

14. Waveform Measurement

AMPTD Y Scale	1271
Ref Value	1271
Ref Value (RF Envelope View)	1271
Ref Value (I/Q Waveform View)	1272
Attenuation	1272
Range	1273
Scale/Div	1273
Scale/Div (RF Envelope View)	1273
Scale/Div (I/Q Waveform View)	1274
Presel Center	1274

Contents

Presel Adjust	1275
Internal Preamp	1275
Ref Position	1275
Ref Position (RF Envelope View)	1275
Ref Position (I/Q Waveform View)	1276
Auto Scaling	1277
Auto Couple	1278
BW	1279
Digital IF BW	1279
Filter Type	1280
Filter Type Bwcc	1282
Gaussian	1282
Flattop	1288
Filter BW	1290
Channel Filter Bandwidth Bwcc (Remote Command Only)	1290
Filter Alpha	1291
Cont	1292
FREQ Channel	1293
Input/Output	1294
Marker	1295
Select Marker	1295
Marker Type	1295
Marker X Axis Value (Remote Command Only)	1296
Marker X Axis Position (Remote Command Only)	1297
Marker Y Axis Value (Remote Command Only)	1298
Properties	1298
Select Marker	1298
Relative To	1299
Marker Trace	1299
Couple Markers	1300
All Markers Off	1301
Backward Compatibility SCPI Commands	1301
Marker Function	1302
Select Marker	1302
Marker Function Type	1302
Band Adjust	1303
Band/Interval Span for Time Domain	1303
Band/Interval Left for Time Domain	1304
Band/Interval Right for Time Domain	1304
Marker To	1306
Meas	1307
Meas Setup	1308
Average/Hold Num	1308
Avg Mode	1308
Avg Type	1309
HW Averaging	1310
Time Avg Num	1310
Sample Rate	1311
Sample Period (Aperture) Setting (Remote Command Only)	1311

Contents

Meas Time	1312
PhNoise Opt	1312
Auto	1313
Best Close-in P Noise	1314
Best Wide-offset P Noise	1314
Advanced	1315
ADC Dither	1315
IF Gain	1317
Meas Preset	1319
Mode	1320
Mode Setup	1321
Peak Search	1322
Next Peak	1322
Min Search	1322
Recall	1324
Restart	1325
Save	1326
Single	1327
Source	1328
Span X Scale	1329
Ref Value	1329
Scale/Div	1329
Ref Position	1330
Auto Scaling	1331
Sweep/Control	1332
Pause and Resume	1332
Trace/Detector	1333
Trigger	1334
View/Display	1335
Display	1336
RF Envelope	1336
I/Q Waveform	1338

15. Conformance EVM

Amplitude (AMPTD) Y Scale	1343
Attenuation	1343
Presel Center	1343
Presel Adjust	1343
μ W Path Control	1343
Internal Preamp	1343
Auto Couple	1344
BW	1345
Info BW	1345
Cont (Continuous)	1346
FREQ Channel	1347
Center Freq	1347
CF Step	1347
Input/Output	1348
Marker	1349

Marker Fctn	1350
Marker > (Marker To)	1351
Meas	1352
Meas Setup	1353
Meas Method (PXA with option B1X or B1Y only)	1353
Fast Mode Limitation	1353
Copy from Mod Analysis Measurement	1355
Meas Preset	1355
Result Values	1356
Downlink Result Output Selection	1356
Uplink Result Output Selection	1357
Mode	1360
Mode Setup	1361
Peak Search	1362
Recall	1363
Restart	1364
Save	1365
Single	1366
Source	1367
SPAN X Scale	1368
Sweep/Control	1369
Trace/Detector	1370
Trigger	1371
View/Display	1372
Display	1372
Measurement List view	1372
Show All Items	1373
Parameter List view	1373
Value	1374
Result Metrics view	1374
RF Envelope view	1375

16. Common Measurement Functions

Common Measurement Functions 1	1379
AMPTD Y Scale	1379
Reference Level	1379
Attenuation	1381
Range	1390
Scale / Div	1395
Scale Type	1396
Presel Center	1396
Preselector Adjust	1398
Y Axis Unit	1399
Reference Level Offset	1404
μ W Path Control	1405
Internal Preamp	1410
Auto Couple	1412
Cont (Continuous Measurement/Sweep)	1413
FREQ Channel	1414

Center Freq	1415
CF Step	1421
Input/Output	1422
RF Input.	1425
External Mixer.	1430
I/Q	1450
RF Calibrator.	1467
External Gain	1469
Restore Input/Output Defaults	1474
Data Source	1474
Corrections	1479
Freq Ref In	1490
Output Config	1495
I/Q Guided Calibration	1508
Meas	1520
Remote Measurement Functions.	1520
Mode	1534
Application Mode Number Selection (Remote Command Only).	1537
Application Mode Catalog Query (Remote Command Only)	1538
Application Identification (Remote Commands Only).	1539
Application Identification Catalog (Remote Commands Only)	1540
Detailed List of Modes	1542
Global Settings	1551
Global Center Freq	1552
Restore Defaults	1552
Mode Setup	1553
Direction	1553
Demod	1553
Preset to Standard	1556
Noise Reduction	1556
Restore Mode Defaults	1558
Global Settings	1558
Restart	1558
Save.	1560
Amplitude Correction	1560
Single (Single Measurement/Sweep)	1563
Source	1564
Sweep/Control.	1564
Sweep Time.	1564
Sweep Setup	1567
Pause/Resume	1577
Gate	1578
Points	1592
Zoom Points	1594
Abort (Remote Command Only).	1595
Trigger	1595
Free Run	1604
Video (IF Envelope)	1605
Line	1609

External 1	1611
External 2	1613
RF Burst	1616
Periodic Timer (Frame Trigger)	1620
TV	1628
Baseband I/Q	1634
Auto/Holdoff	1644
View/Display	1646
Display	1646
Full Screen	1655
Display Enable (Remote Command Only)	1655
Common Measurement Functions 2	1657
AMPTD Y Scale (Amplitude)	1657
Range	1657
Y Axis Scaling	1658
BW (Bandwidth)	1664
Res BW	1664
Res BW Coupling	1665
FFT Window	1667
FREQ Channel	1667
Center Freq	1668
Start Freq	1669
Stop Freq	1669
CF Step	1670
Marker	1670
Select Marker	1671
Control Mode	1671
Marker Position	1675
Marker Properties	1681
Marker Table	1685
Couple Markers	1685
All Markers Off	1686
Marker -> (Marker To)	1686
Mkr -> CF (Center Frequency)	1687
Mkr -> CF Step	1687
Mkr -> Start	1687
Mkr -> Stop	1688
Mkr Delta -> Span	1688
Mkr -> Ref Lvl	1688
Counter -> CF (Center Frequency)	1689
Mkr Delta -> CF (Center Frequency)	1689
Marker Function	1689
Band/Interval Power	1690
Band/Interval Density	1692
Band Adjust	1694
Band Power and Delta Markers	1696
Meas Setup	1697
Avg Number	1697
Average Mode	1698

Average Setup	1699
PhNoise Opt	1701
Mode Setup	1703
Spectrum	1703
Fixed Equalization.	1703
IF Path	1705
Peak Search	1706
Next Peak (Next Lower Amptd)	1707
Next Higher Amptd.	1707
Next Right	1708
Next Left	1708
Mkr -> CF (Center Frequency)	1709
Continuous Peak Search	1709
Min Search	1710
Mkr -> Ref Lvl (Reference Level)	1710
Recall.	1710
State	1711
Data (Import)	1711
Save	1713
State	1713
Data (Export)	1713
Screen Image	1716
SPAN X Scale	1716
Span.	1716
Full Span	1717
Signal Track	1717
X Axis Scaling	1718
Sweep/Control	1724
Main Time	1724
Pause / Resume	1725
Abort	1725
Gate	1725
Freq Points.	1727
Trace/Detector	1728
Select Trace	1728
Data	1730
Format	1747
Digital Demod Trace Setup	1748
Copy to Data Register	1753
Phase/Delay Properties	1754
ACP Setup	1757
OBW Setup (Occupied Bandwidth)	1765
Register	1768
Trace Indicator Info	1770
Trigger	1770
Trig Reference Line.	1771
Hardware Trigger	1772
View/Display	1786
Layout	1786

Remote SCPI Commands and Data Queries	1789
:CALCulate:DATA	1793
:CALCulate:DATA:RAW	1794
:CALCulate:DATA:RAW:COMPLex	1795
:CALCulate:DATA:POINts commands	1795
:CALCulate:DATA:TABL commands	1796
:CALCulate:DATA:HEADer commands	1800
:CALC:CLIMits:FAIL?	1803
IQ Data Transfers	1803
Parameter Update Enable	1807

List of Commands

:ABORt.....	1595
Add PUSCH Slot	1354
*CAL?	251
:CALC:EVM:DATA4:TABL:STR? "FreqErr"	843
:CALCulate:<meas>:DATA[1] 2 3 4? [Y X XY[,OFF ON 0 1]]	1794
:CALCulate:<meas>:DATA[1] 2 3 4:HEADer:NAMes?	1801
:CALCulate:<meas>:DATA[1] 2 3 4:HEADer[:NUMBer]? <string>	1802
:CALCulate:<meas>:DATA[1] 2 3 4:HEADer:STRing? <string>	1802
:CALCulate:<meas>:DATA[1] 2 3 4:HEADer:TYPE? <string>	1801
:CALCulate:<meas>:DATA[1] 2 3 4:NAMes?	1731
:CALCulate:<meas>:DATA[1] 2 3 4:POINts? [OFF ON 0 1]	1796
:CALCulate:<meas>:DATA[1] 2 3 4:RAW?	1795
:CALCulate:<meas>:DATA[1] 2 3 4:RAW:COMPLex?	1795
:CALCulate:<meas>:DATA[1] 2 3 4:RAW:POINts?	1796
:CALCulate:<meas>:DATA[1] 2 3 4:TABLe:NAMes?	1799
:CALCulate:<meas>:DATA[1] 2 3 4:TABLe[:NUMBer]? [<string>]	1797
:CALCulate:<meas>:DATA[1] 2 3 4:TABLe:STRing? [<string>]	1798
:CALCulate:<meas>:DATA[1] 2 3 4:TABLe:UNIT?	1799
:CALCulate:<meas>:MARKer[1] 2 3 4 5 6 7 8 9 10 11 12: MODE?	1672
:CALCulate:<meas>:MARKer[1] 2 3 4 5 6 7 8 9 10 11 12: CFORmat RECTAngular POLar	1683
:CALCulate:<meas>:MARKer[1] 2 3 4 5 6 7 8 9 10 11 12: CFORmat?	1683
:CALCulate:<meas>:MARKer[1] 2 3 4 5 6 7 8 9 10 11 12: CPSeArch[:STATe] ON OFF 1 0	1709
:CALCulate:<meas>:MARKer[1] 2 3 4 5 6 7 8 9 10 11 12: CPSeArch[:STATe]?	1709
:CALCulate:<meas>:MARKer[1] 2 3 4 5 6 7 8 9 10 11 12: FCOunt[:STATe] OFF ON 0 1	1684
:CALCulate:<meas>:MARKer[1] 2 3 4 5 6 7 8 9 10 11 12: FCOunt[:STATe]?	1684
:CALCulate:<meas>:MARKer[1] 2 3 4 5 6 7 8 9 10 11 12: FCOunt:X?	1684
:CALCulate:<meas>:MARKer[1] 2 3 4 5 6 7 8 9 10 11 12: FUNCTion BPOWer BDENsity =OFF	1690
:CALCulate:<meas>:MARKer[1] 2 3 4 5 6 7 8 9 10 11 12: FUNCTion?	1690
:CALCulate:<meas>:MARKer[1] 2 3 4 5 6 7 8 9 10 11 12: FUNCTion:BAND:CENTer <real>	1694
:CALCulate:<meas>:MARKer[1] 2 3 4 5 6 7 8 9 10 11 12: FUNCTion:BAND:CENTer?	1694
:CALCulate:<meas>:MARKer[1] 2 3 4 5 6 7 8 9 10 11 12: FUNCTion:BAND:LEFT <real>	1695

List of Commands

:CALCulate:<meas>:MARKer[1] 2 3 4 5 6 7 8 9 10 11 12: FUNCtion:BAND:LEFT?	1695
:CALCulate:<meas>:MARKer[1] 2 3 4 5 6 7 8 9 10 11 12: FUNCtion:BAND:RIGHT <real>	1696
:CALCulate:<meas>:MARKer[1] 2 3 4 5 6 7 8 9 10 11 12: FUNCtion:BAND:RIGHT?	1696
:CALCulate:<meas>:MARKer[1] 2 3 4 5 6 7 8 9 10 11 12: FUNCtion:BAND:SPAN <real>.	1695
:CALCulate:<meas>:MARKer[1] 2 3 4 5 6 7 8 9 10 11 12: FUNCtion:BAND:SPAN?	1695
:CALCulate:<meas>:MARKer[1] 2 3 4 5 6 7 8 9 10 11 12: FUNCtion:BDENsity:CTYPe MEAN RMS	1693
:CALCulate:<meas>:MARKer[1] 2 3 4 5 6 7 8 9 10 11 12: FUNCtion:BDENsity:CTYPe?	1693
:CALCulate:<meas>:MARKer[1] 2 3 4 5 6 7 8 9 10 11 12: FUNCtion:BPOWer:CTYPe MEAN RMS	1692
:CALCulate:<meas>:MARKer[1] 2 3 4 5 6 7 8 9 10 11 12: FUNCtion:BPOWer:CTYPe?	1692
:CALCulate:<meas>:MARKer[1] 2 3 4 5 6 7 8 9 10 11 12: MAXimum	1707
:CALCulate:<meas>:MARKer[1] 2 3 4 5 6 7 8 9 10 11 12: MAXimum:LEFT	1709
:CALCulate:<meas>:MARKer[1] 2 3 4 5 6 7 8 9 10 11 12: MAXimum:NEXT	1707
:CALCulate:<meas>:MARKer[1] 2 3 4 5 6 7 8 9 10 11 12: MAXimum:PREVious	1708
:CALCulate:<meas>:MARKer[1] 2 3 4 5 6 7 8 9 10 11 12: MAXimum:RIGHT	1708
:CALCulate:<meas>:MARKer[1] 2 3 4 5 6 7 8 9 10 11 12: MINimum	1710
:CALCulate:<meas>:MARKer[1] 2 3 4 5 6 7 8 9 10 11 12: MODE POSition DELTA FIXed=OFF	1672
:CALCulate:<meas>:MARKer[1] 2 3 4 5 6 7 8 9 10 11 12: REFerence <integer>	1682
:CALCulate:<meas>:MARKer[1] 2 3 4 5 6 7 8 9 10 11 12: REFerence?	1682
:CALCulate:<meas>:MARKer[1] 2 3 4 5 6 7 8 9 10 11 12: TRACe <integer>	1683
:CALCulate:<meas>:MARKer[1] 2 3 4 5 6 7 8 9 10 11 12: TRACe?	1683
:CALCulate:<meas>:MARKer[1] 2 3 4 5 6 7 8 9 10 11 12 [:X]:POSition <real>	1677
:CALCulate:<meas>:MARKer[1] 2 3 4 5 6 7 8 9 10 11 12 [:X]:POSition?	1677
:CALCulate:<meas>:MARKer[1] 2 3 4 5 6 7 8 9 10 11 12:X <real>	1676
:CALCulate:<meas>:MARKer[1] 2 3 4 5 6 7 8 9 10 11 12:X?	1676
:CALCulate:<meas>:MARKer[1] 2 3 4 5 6 7 8 9 10 11 12:X:UNIT?	1678
:CALCulate:<meas>:MARKer[1] 2 3 4 5 6 7 8 9 10 11 12:Y [:REAL] <real>	1678
:CALCulate:<meas>:MARKer[1] 2 3 4 5 6 7 8 9 10 11 12:Y [:REAL]?	1678
:CALCulate:<meas>:MARKer[1] 2 3 4 5 6 7 8 9 10 11 12:Y:IMAGinary <real>	1680
:CALCulate:<meas>:MARKer[1] 2 3 4 5 6 7 8 9 10 11 12:Y:IMAGinary?	1680
:CALCulate:<meas>:MARKer[1] 2 3 4 5 6 7 8 9 10 11 12:Y:UNIT?	1679
:CALCulate:<meas>:MARKer[1] 2 3 4 5 6 7 8 9 10 11 12:Z <real>	1680

List of Commands

:CALCulate:<meas>:MARKer[1] 2 3 4 5 6 7 8 9 10 11 12:Z?	1680
:CALCulate:<meas>:MARKer[1] 2 3 4 5 6 7 8 9 10 11 12:Z:UNIT?	1681
:CALCulate:<meas>:MARKer:AOFF	1686
:CALCulate:<meas>:MARKer:COUPle[:STATe] OFF ON 0 1	1686
:CALCulate:<meas>:MARKer:COUPle[:STATe]?	1686
:CALCulate:<meas>:MARKer:TABLE[:STATe] OFF ON 0 1	1685
:CALCulate:<meas>:MARKer:TABLE[:STATe]?	1685
:CALCulate:<meas>:TRACe[1] 2 3 4:ACPoweR:CARRier: BANDwidth BWIDth:INTegration <bandwidth>	1760
:CALCulate:<meas>:TRACe[1] 2 3 4:ACPoweR:CARRier: BANDwidth BWIDth:INTegration?	1760
:CALCulate:<meas>:TRACe[1] 2 3 4:ACPoweR:CARRier: FILTer:RRC:ALPHa <real>	1761
:CALCulate:<meas>:TRACe[1] 2 3 4:ACPoweR:CARRier: FILTer:RRC:ALPHa?	1761
:CALCulate:<meas>:TRACe[1] 2 3 4:ACPoweR:CARRier: FILTer:RRC:STATe OFF ON 0 1	1760
:CALCulate:<meas>:TRACe[1] 2 3 4:ACPoweR:CARRier: FILTer:RRC:STATe?	1760
:CALCulate:<meas>:TRACe[1] 2 3 4:ACPoweR:CARRier: FREQuency <freq>	1759
:CALCulate:<meas>:TRACe[1] 2 3 4:ACPoweR:CARRier: FREQuency?	1759
:CALCulate:<meas>:TRACe[1] 2 3 4:ACPoweR:OFFSet:FILTer:RRC:STATe OFF ON 0 1	1765
:CALCulate:<meas>:TRACe[1] 2 3 4:ACPoweR:OFFSet:FILTer:RRC:STATe?	1765
:CALCulate:<meas>:TRACe[1] 2 3 4:ACPoweR:OFFSet:LIST: BANDwidth BWIDth:INTegration <bandwidth>,...	1763
:CALCulate:<meas>:TRACe[1] 2 3 4:ACPoweR:OFFSet:LIST: BANDwidth BWIDth:INTegration?	1763
:CALCulate:<meas>:TRACe[1] 2 3 4:ACPoweR:OFFSet:LIST: FILTer:RRC:ALPHa <real>,...	1763
:CALCulate:<meas>:TRACe[1] 2 3 4:ACPoweR:OFFSet:LIST: FILTer:RRC:ALPHa?	1763
:CALCulate:<meas>:TRACe[1] 2 3 4:ACPoweR:OFFSet:LIST: FREQuency <freq>,...	1762
:CALCulate:<meas>:TRACe[1] 2 3 4:ACPoweR:OFFSet:LIST: FREQuency?	1762
:CALCulate:<meas>:TRACe[1] 2 3 4:ACPoweR:OFFSet:LIST: RCARRier <real>,...	1764
:CALCulate:<meas>:TRACe[1] 2 3 4:ACPoweR:OFFSet:LIST: RCARRier?	1764
:CALCulate:<meas>:TRACe[1] 2 3 4:ACPoweR:OFFSet:LIST: RCARRier:TEST OFF ON 0 1,...	1764
:CALCulate:<meas>:TRACe[1] 2 3 4:ACPoweR:OFFSet:LIST: RCARRier:TEST?	1764
:CALCulate:<meas>:TRACe[1] 2 3 4:ACPoweR:OFFSet:LIST: STATe OFF ON 0 1,...	1762
:CALCulate:<meas>:TRACe[1] 2 3 4:ACPoweR:OFFSet:LIST: STATe?	1762
:CALCulate:<meas>:TRACe[1] 2 3 4:ACPoweR:STATe OFF ON 0 1	1759

List of Commands

:CALCulate:<meas>:TRACe[1] 2 3 4:ACPower:STATe?	1759
:CALCulate:<meas>:TRACe[1] 2 3 4:OBWidth:CENtroid?	1767
:CALCulate:<meas>:TRACe[1] 2 3 4:OBWidth:LIMit:FBLimit <freq>	1768
:CALCulate:<meas>:TRACe[1] 2 3 4:OBWidth:LIMit:FBLimit?	1768
:CALCulate:<meas>:TRACe[1] 2 3 4:OBWidth:LIMit[:TEST] OFF ON 0 1	1768
:CALCulate:<meas>:TRACe[1] 2 3 4:OBWidth:LIMit[:TEST]?	1768
:CALCulate:<meas>:TRACe[1] 2 3 4:OBWidth:PERCent <real>	1767
:CALCulate:<meas>:TRACe[1] 2 3 4:OBWidth:PERCent?	1767
:CALCulate:<meas>:TRACe[1] 2 3 4:OBWidth:STATe OFF ON 0 1	1767
:CALCulate:<meas>:TRACe[1] 2 3 4:OBWidth:STATe?	1767
:CALCulate:ACPower:LIMit:STATe OFF ON 0 1	537
:CALCulate:ACPower:LIMit:STATe?	537
:CALCulate:ACPower:MARKer[1] 2 3 4 5 6 7 8 9 10 11 12:MAXimum	545
:CALCulate:ACPower:MARKer[1] 2 3 4 5 6 7 8 9 10 11 12:MAXimum:LEFT	546
:CALCulate:ACPower:MARKer[1] 2 3 4 5 6 7 8 9 10 11 12:MAXimum:NEXT	545
:CALCulate:ACPower:MARKer[1] 2 3 4 5 6 7 8 9 10 11 12:MAXimum:RIGHT	546
:CALCulate:ACPower:MARKer[1] 2 3 4 5 6 7 8 9 10 11 12:MINimum	547
:CALCulate:ACPower:MARKer[1] 2 3 4 5 6 7 8 9 10 11 12:MODE POSition DELTA OFF	484
:CALCulate:ACPower:MARKer[1] 2 3 4 5 6 7 8 9 10 11 12:MODE?	484
:CALCulate:ACPower:MARKer[1] 2 3 4 5 6 7 8 9 10 11 12:PTPeak	546
:CALCulate:ACPower:MARKer[1] 2 3 4 5 6 7 8 9 10 11 12:REFerence <integer>	488
:CALCulate:ACPower:MARKer[1] 2 3 4 5 6 7 8 9 10 11 12:REFerence?	488
:CALCulate:ACPower:MARKer[1] 2 3 4 5 6 7 8 9 10 11 12:STATe OFF ON 0 1	490
:CALCulate:ACPower:MARKer[1] 2 3 4 5 6 7 8 9 10 11 12:STATe?	490
:CALCulate:ACPower:MARKer[1] 2 3 4 5 6 7 8 9 10 11 12:TRACe 1 2 3	488
:CALCulate:ACPower:MARKer[1] 2 3 4 5 6 7 8 9 10 11 12:TRACe?	488
:CALCulate:ACPower:MARKer[1] 2 3 4 5 6 7 8 9 10 11 12:X <freq>	485
:CALCulate:ACPower:MARKer[1] 2 3 4 5 6 7 8 9 10 11 12:X?	485
:CALCulate:ACPower:MARKer[1] 2 3 4 5 6 7 8 9 10 11 12:X:POSition <real>	486
:CALCulate:ACPower:MARKer[1] 2 3 4 5 6 7 8 9 10 11 12:X:POSition?	486
:CALCulate:ACPower:MARKer[1] 2 3 4 5 6 7 8 9 10 11 12:Y?	487

List of Commands

:CALCulate:ACPower:MARKer:AOff	490
:CALCulate:ACPower:MARKer:COUple[:STATe] ON OFF 1 0	489
:CALCulate:ACPower:MARKer:COUple[:STATe]?	489
:CALCulate:ACPower:OFFSet:LIST:LIMit:NEGative[:UPPer]:DATA <real>, <real>, <real>, <real>, <real>, <real>	524
:CALCulate:ACPower:OFFSet:LIST:LIMit:NEGative[:UPPer]:DATA?	524
:CALCulate:ACPower:OFFSet:LIST:LIMit:POSitive[:UPPer]:DATA <real>, <real>, <real>, <real>, <real>, <real>	523
:CALCulate:ACPower:OFFSet:LIST:LIMit:POSitive[:UPPer]:DATA?	523
:CALCulate:CHPower:LIMit:POWer <amp;l>	355
:CALCulate:CHPower:LIMit:POWer?	355
:CALCulate:CHPower:LIMit:POWer:FAIL?	356
:CALCulate:CHPower:LIMit:POWer:STATe OFF ON 0 1	355
:CALCulate:CHPower:LIMit:POWer:STATe?	355
:CALCulate:CHPower:LIMit:PSDensity <real>	356
:CALCulate:CHPower:LIMit:PSDensity?	356
:CALCulate:CHPower:LIMit:PSDensity:STATe OFF ON 0 1	356
:CALCulate:CHPower:LIMit:PSDensity:STATe?	356
:CALCulate:CHPower:LIMit:PSD:FAIL?	357
:CALCulate:CHPower:MARKer[1] 2 3 4 5 6 7 8 9 10 11 12:MAXimum	363
:CALCulate:CHPower:MARKer[1] 2 3 4 5 6 7 8 9 10 11 12:MODE POSition DELTA OFF	335
:CALCulate:CHPower:MARKer[1] 2 3 4 5 6 7 8 9 10 11 12:MODE?	335
:CALCulate:CHPower:MARKer[1] 2 3 4 5 6 7 8 9 10 11 12:REFerence <integer>	338
:CALCulate:CHPower:MARKer[1] 2 3 4 5 6 7 8 9 10 11 12:REFerence?	338
:CALCulate:CHPower:MARKer[1] 2 3 4 5 6 7 8 9 10 11 12:STATe OFF ON 0 1	340
:CALCulate:CHPower:MARKer[1] 2 3 4 5 6 7 8 9 10 11 12:STATe?	340
:CALCulate:CHPower:MARKer[1] 2 3 4 5 6 7 8 9 10 11 12:TRACe RFSpectrum LSHoulder RSHoulder MASK	339
:CALCulate:CHPower:MARKer[1] 2 3 4 5 6 7 8 9 10 11 12:TRACe RFSpectrum LSHoulder RSHoulder	339
:CALCulate:CHPower:MARKer[1] 2 3 4 5 6 7 8 9 10 11 12:TRACe?	339
:CALCulate:CHPower:MARKer[1] 2 3 4 5 6 7 8 9 10 11 12:TRACe?	339
:CALCulate:CHPower:MARKer[1] 2 3 4 5 6 7 8 9 10 11 12:X <real>	336

List of Commands

:CALCulate:CHPower:MARKer[1] 2 3 4 5 6 7 8 9 10 11 12:X?	336
:CALCulate:CHPower:MARKer[1] 2 3 4 5 6 7 8 9 10 11 12:X:POSition <real>	337
:CALCulate:CHPower:MARKer[1] 2 3 4 5 6 7 8 9 10 11 12:X:POSition?	337
:CALCulate:CHPower:MARKer[1] 2 3 4 5 6 7 8 9 10 11 12:Y?	337
:CALCulate:CHPower:MARKer:AOFF	340
:CALCulate:CHPower:MARKer:COUple[:STATe] ON OFF 1 0	340
:CALCulate:CHPower:MARKer:COUple[:STATe]?	340
:CALCulate:CHPower:MASK:STATe ON OFF 1 0	396
:CALCulate:CHPower:MASK:STATe?	396
:CALCulate:CLIMits:FAIL?	1525
:CALCulate:DATA<n>:COMPress? BLOCk CFIT MAXimum MINimum MEAN DMEan RMS RM- SCubed SAMPLE SDEVIation PPHase [,<soffset>,<length>,<roffset>,<rlimit>]]]	1526
:CALCulate:DATA[1] 2 3 4 5 6:PEAKs? <threshold>,<excursion>[,AMPLitude FREQuency TIME]	1531
:CALCulate:DATA[1] 2 3 4 5 6:PEAKs? <threshold>,<excursion>[,AMPLitude FREQuency TIME[,ALL GTD- Line LTDLine]]	1531
:CALCulate:DATA[n]?	1525
:CALCulate:DATA:REGister[1] 2 3 4 5 6:EMPTy?	1754
:CALCulate:DATA:REGister[1] 2 3 4 5 6:REMove	1754
:CALCulate:DATA:REGister:ALL:REMove	1754
:CALCulate:EVM:DATA<n>:TABLe:NAMes?	843
:CALCulate:EVM:DATA<n>:TABLe:STRing?	843
:CALCulate:EVM:DATA<n>:TABLe:UNIT?	843
:CALCulate:MONitor:MARKer[1] 2 3 4 5 6 7 8 9 10 11 12:FUNcTion NOISe BPOWer BDENsity OFF	1237
:CALCulate:MONitor:MARKer[1] 2 3 4 5 6 7 8 9 10 11 12:FUNcTion?	1237
:CALCulate:MONitor:MARKer[1] 2 3 4 5 6 7 8 9 10 11 12:FUNcTion:BAND:LEFT <freq>	1238
:CALCulate:MONitor:MARKer[1] 2 3 4 5 6 7 8 9 10 11 12:FUNcTion:BAND:LEFT?	1238
:CALCulate:MONitor:MARKer[1] 2 3 4 5 6 7 8 9 10 11 12:FUNcTion:BAND:RIGHT <freq>	1239
:CALCulate:MONitor:MARKer[1] 2 3 4 5 6 7 8 9 10 11 12:FUNcTion:BAND:RIGHT?	1239
:CALCulate:MONitor:MARKer[1] 2 3 4 5 6 7 8 9 10 11 12:FUNcTion:BAND:SPAN <freq>	1238
:CALCulate:MONitor:MARKer[1] 2 3 4 5 6 7 8 9 10 11 12:FUNcTion:BAND:SPAN?	1238
:CALCulate:MONitor:MARKer[1] 2 3 4 5 6 7 8 9 10 11 12:MAXimum.	1246
:CALCulate:MONitor:MARKer[1] 2 3 4 5 6 7 8 9 10 11 12:MODE POSition DELTA OFF	1232

List of Commands

:CALCulate:MONitor:MARKer[1] 2 3 4 5 6 7 8 9 10 11 12:MODE?	1232
:CALCulate:MONitor:MARKer[1] 2 3 4 5 6 7 8 9 10 11 12:REfERENCE <integer>	1235
:CALCulate:MONitor:MARKer[1] 2 3 4 5 6 7 8 9 10 11 12:REfERENCE?	1235
:CALCulate:MONitor:MARKer[1] 2 3 4 5 6 7 8 9 10 11 12:TRACe <integer>	1235
:CALCulate:MONitor:MARKer[1] 2 3 4 5 6 7 8 9 10 11 12:TRACe?	1235
:CALCulate:MONitor:MARKer[1] 2 3 4 5 6 7 8 9 10 11 12:X <freq>	1233
:CALCulate:MONitor:MARKer[1] 2 3 4 5 6 7 8 9 10 11 12:X?	1233
:CALCulate:MONitor:MARKer[1] 2 3 4 5 6 7 8 9 10 11 12:X:POSition <real>	1233
:CALCulate:MONitor:MARKer[1] 2 3 4 5 6 7 8 9 10 11 12:X:POSition?	1233
:CALCulate:MONitor:MARKer[1] 2 3 4 5 6 7 8 9 10 11 12:Y?	1234
:CALCulate:MONitor:MARKer:AOFF	1236
:CALCulate:MONitor:MARKer:COUPle[:STATe] ON OFF 1 0	1236
:CALCulate:MONitor:MARKer:COUPle[:STATe]?	1236
:CALCulate:OBWidth:LIMit:FBLimit <freq>	427
:CALCulate:OBWidth:LIMit:FBLimit <freq>	429
:CALCulate:OBWidth:LIMit:FBLimit?	427
:CALCulate:OBWidth:LIMit:FBLimit?	429
:CALCulate:OBWidth:LIMit[:TEST] ON OFF 1 0	427
:CALCulate:OBWidth:LIMit[:TEST] ON OFF 1 0	429
:CALCulate:OBWidth:LIMit[:TEST]?	427
:CALCulate:OBWidth:LIMit[:TEST]?	429
:CALCulate:OBWidth:MARKer[1] 2 3 4 5 6 7 8 9 10 11 12:MAXimum	433
:CALCulate:OBWidth:MARKer[1] 2 3 4 5 6 7 8 9 10 11 12:MODE POSition DELTA OFF	416
:CALCulate:OBWidth:MARKer[1] 2 3 4 5 6 7 8 9 10 11 12:MODE?	416
:CALCulate:OBWidth:MARKer[1] 2 3 4 5 6 7 8 9 10 11 12:REfERENCE <integer>	417
:CALCulate:OBWidth:MARKer[1] 2 3 4 5 6 7 8 9 10 11 12:REfERENCE?	417
:CALCulate:OBWidth:MARKer[1] 2 3 4 5 6 7 8 9 10 11 12:STATe OFF ON 0 1	418
:CALCulate:OBWidth:MARKer[1] 2 3 4 5 6 7 8 9 10 11 12:STATe?	418
:CALCulate:OBWidth:MARKer[1] 2 3 4 5 6 7 8 9 10 11 12:X <freq>	414
:CALCulate:OBWidth:MARKer[1] 2 3 4 5 6 7 8 9 10 11 12:X?	414
:CALCulate:OBWidth:MARKer[1] 2 3 4 5 6 7 8 9 10 11 12:X:POSition <real>	415

List of Commands

:CALCulate:OBWidth:MARKer[1] 2 3 4 5 6 7 8 9 10 11 12:X:POSition?	415
:CALCulate:OBWidth:MARKer[1] 2 3 4 5 6 7 8 9 10 11 12:Y?	415
:CALCulate:OBWidth:MARKer:AOff	418
:CALCulate:PStatistic:MARKer[1] 2 3 4 5 6 7 8 9 10 11 12:MODE POSition DELTA OFF	588
:CALCulate:PStatistic:MARKer[1] 2 3 4 5 6 7 8 9 10 11 12:MODE?	588
:CALCulate:PStatistic:MARKer[1] 2 3 4 5 6 7 8 9 10 11 12:REFeRence <integer>	591
:CALCulate:PStatistic:MARKer[1] 2 3 4 5 6 7 8 9 10 11 12:REFeRence?	591
:CALCulate:PStatistic:MARKer[1] 2 3 4 5 6 7 8 9 10 11 12:TRACe MEASured GAUSSian REFeRence	591
:CALCulate:PStatistic:MARKer[1] 2 3 4 5 6 7 8 9 10 11 12:TRACe?	591
:CALCulate:PStatistic:MARKer[1] 2 3 4 5 6 7 8 9 10 11 12:X <rel_amp>	589
:CALCulate:PStatistic:MARKer[1] 2 3 4 5 6 7 8 9 10 11 12:X?	589
:CALCulate:PStatistic:MARKer[1] 2 3 4 5 6 7 8 9 10 11 12:Y?	590
:CALCulate:PStatistic:MARKer:AOff	592
:CALCulate:PStatistic:STORe:REFeRence	612
:CALCulate:SEMAsk:LLINe:STATe ON OFF 1 0	841
:CALCulate:SEMAsk:LLINe:STATe?	841
:CALCulate:SEMAsk:MARKer[1] 2 3 4 5 6 7 8 9 10 11 12:MODE POSition OFF	736
:CALCulate:SEMAsk:MARKer[1] 2 3 4 5 6 7 8 9 10 11 12:MODE?	736
:CALCulate:SEMAsk:MARKer[1] 2 3 4 5 6 7 8 9 10 11 12:X <freq>	737
:CALCulate:SEMAsk:MARKer[1] 2 3 4 5 6 7 8 9 10 11 12:X?	737
:CALCulate:SEMAsk:MARKer[1] 2 3 4 5 6 7 8 9 10 11 12:X:POSition <real>	738
:CALCulate:SEMAsk:MARKer[1] 2 3 4 5 6 7 8 9 10 11 12:X:POSition?	738
:CALCulate:SEMAsk:MARKer[1] 2 3 4 5 6 7 8 9 10 11 12:Y?	738
:CALCulate:SEMAsk:MARKer:AOff	739
:CALCulate:SEMAsk:MARKer:COUPle[:STATe] ON OFF 1 0	739
:CALCulate:SEMAsk:MARKer:COUPle[:STATe]?	739
:CALCulate:SPURious:MARKer[1] 2 3 4 5 6 7 8 9 10 11 12:MAXimum	678
:CALCulate:SPURious:MARKer[1] 2 3 4 5 6 7 8 9 10 11 12:MAXimum:LEFT	679
:CALCulate:SPURious:MARKer[1] 2 3 4 5 6 7 8 9 10 11 12:MAXimum:NEXT	678
:CALCulate:SPURious:MARKer[1] 2 3 4 5 6 7 8 9 10 11 12:MAXimum:RIGHT	678
:CALCulate:SPURious:MARKer[1] 2 3 4 5 6 7 8 9 10 11 12:MINimum	680

List of Commands

:CALCulate:SPURious:MARKer[1] 2 3 4 5 6 7 8 9 10 11 12:MODE POSition DELTA OFF	632
:CALCulate:SPURious:MARKer[1] 2 3 4 5 6 7 8 9 10 11 12:MODE?	632
:CALCulate:SPURious:MARKer[1] 2 3 4 5 6 7 8 9 10 11 12:PTPeak	679
:CALCulate:SPURious:MARKer[1] 2 3 4 5 6 7 8 9 10 11 12:REFerence <integer>	635
:CALCulate:SPURious:MARKer[1] 2 3 4 5 6 7 8 9 10 11 12:REFerence?	635
:CALCulate:SPURious:MARKer[1] 2 3 4 5 6 7 8 9 10 11 12:X <freq>	633
:CALCulate:SPURious:MARKer[1] 2 3 4 5 6 7 8 9 10 11 12:X?	633
:CALCulate:SPURious:MARKer[1] 2 3 4 5 6 7 8 9 10 11 12:X:POSition <integer>	634
:CALCulate:SPURious:MARKer[1] 2 3 4 5 6 7 8 9 10 11 12:X:POSition?	634
:CALCulate:SPURious:MARKer[1] 2 3 4 5 6 7 8 9 10 11 12:Y?	634
:CALCulate:SPURious:MARKer:AOFF	637
:CALCulate:SPURious:MARKer:COUPlE[:STATe] ON OFF 1 0	636
:CALCulate:SPURious:MARKer:COUPlE[:STATe]?	636
:CALCulate:SPURious[:RANGe][:LIST]:LIMit:ABSolute[:UPPer]:DATA[:START] <ampl>, <ampl>, <ampl>, <ampl>, <ampl>, <ampl>, <ampl>, <ampl>, <ampl>, <ampl>, <ampl>, <ampl>, <ampl>, <ampl>, <ampl>, <ampl>	653
:CALCulate:SPURious[:RANGe][:LIST]:LIMit:ABSolute[:UPPer]:DATA[:START]?	653
:CALCulate:SPURious[:RANGe][:LIST]:LIMit:ABSolute[:UPPer]:DATA:STOP <ampl>, <ampl>, <ampl>, <ampl>, <ampl>, <ampl>, <ampl>, <ampl>, <ampl>, <ampl>, <ampl>, <ampl>, <ampl>, <ampl>, <ampl>, <ampl>	654
:CALCulate:SPURious[:RANGe][:LIST]:LIMit:ABSolute[:UPPer]:DATA:STOP?	654
:CALCulate:SPURious[:RANGe][:LIST]:LIMit:ABSolute[:UPPer]:DATA:STOP:AUTO OFF ON 0 1, OFF ON 0 1, OFF ON 0 1, OFF ON 0 1, OFF ON 0 1, OFF ON 0 1, OFF ON 0 1, OFF ON 0 1, OFF ON 0 1, OFF ON 0 1, OFF ON 0 1, OFF ON 0 1, OFF ON 0 1, OFF ON 0 1, OFF ON 0 1, OFF ON 0 1, OFF ON 0 1	654
:CALCulate:SPURious[:RANGe][:LIST]:LIMit:ABSolute[:UPPer]:DATA:STOP:AUTO?	654
:CALCulate:WAVeform:MARKer[1] 2 3 4 5 6 7 8 9 10 11 12:FUNCTion BPOWer BDENsity OFF	1302
:CALCulate:WAVeform:MARKer[1] 2 3 4 5 6 7 8 9 10 11 12:FUNCTion?	1302
:CALCulate:WAVeform:MARKer[1] 2 3 4 5 6 7 8 9 10 11 12:FUNCTion:BAND:LEFT <time>	1304
:CALCulate:WAVeform:MARKer[1] 2 3 4 5 6 7 8 9 10 11 12:FUNCTion:BAND:LEFT?	1304
:CALCulate:WAVeform:MARKer[1] 2 3 4 5 6 7 8 9 10 11 12:FUNCTion:BAND:RIGHT <time>	1305
:CALCulate:WAVeform:MARKer[1] 2 3 4 5 6 7 8 9 10 11 12:FUNCTion:BAND:RIGHT?	1305
:CALCulate:WAVeform:MARKer[1] 2 3 4 5 6 7 8 9 10 11 12:FUNCTion:BAND:SPAN <time>	1303
:CALCulate:WAVeform:MARKer[1] 2 3 4 5 6 7 8 9 10 11 12:FUNCTion:BAND:SPAN?	1303

List of Commands

:CALCulate:WAVEform:MARKer[1] 2 3 4 5 6 7 8 9 10 11 12:MAXimum	1322
:CALCulate:WAVEform:MARKer[1] 2 3 4 5 6 7 8 9 10 11 12:MAXimum:NEXT	1322
:CALCulate:WAVEform:MARKer[1] 2 3 4 5 6 7 8 9 10 11 12:MINimum	1323
:CALCulate:WAVEform:MARKer[1] 2 3 4 5 6 7 8 9 10 11 12:MODE POSition DELTA OFF	1295
:CALCulate:WAVEform:MARKer[1] 2 3 4 5 6 7 8 9 10 11 12:MODE?	1295
:CALCulate:WAVEform:MARKer[1] 2 3 4 5 6 7 8 9 10 11 12:REFeRence <integer>	1299
:CALCulate:WAVEform:MARKer[1] 2 3 4 5 6 7 8 9 10 11 12:REFeRence?	1299
:CALCulate:WAVEform:MARKer[1] 2 3 4 5 6 7 8 9 10 11 12:STATe OFF ON 0 1	1301
:CALCulate:WAVEform:MARKer[1] 2 3 4 5 6 7 8 9 10 11 12:STATe?	1301
:CALCulate:WAVEform:MARKer[1] 2 3 4 5 6 7 8 9 10 11 12:TRACe RFENvelope I Q IQ	1300
:CALCulate:WAVEform:MARKer[1] 2 3 4 5 6 7 8 9 10 11 12:TRACe?	1300
:CALCulate:WAVEform:MARKer[1] 2 3 4 5 6 7 8 9 10 11 12:X <time>	1296
:CALCulate:WAVEform:MARKer[1] 2 3 4 5 6 7 8 9 10 11 12:X?	1296
:CALCulate:WAVEform:MARKer[1] 2 3 4 5 6 7 8 9 10 11 12:X:POSition <real>	1297
:CALCulate:WAVEform:MARKer[1] 2 3 4 5 6 7 8 9 10 11 12:X:POSition?	1297
:CALCulate:WAVEform:MARKer[1] 2 3 4 5 6 7 8 9 10 11 12:Y?	1298
:CALCulate:WAVEform:MARKer:AOFF	1301
:CALCulate:WAVEform:MARKer:COUPle[:STATe] ON OFF 1 0	1300
:CALCulate:WAVEform:MARKer:COUPle[:STATe]?	1300
:CALibration[:ALL]?	251
:CALibration[:ALL]	251
:CALibration:AUTO ON PARTial OFF	244
:CALibration:AUTO?	244
:CALibration:AUTO:ALERt TTEMperature DAY WEEK NONE	247
:CALibration:AUTO:ALERt?	247
:CALibration:AUTO:MODE ALL NRF	247
:CALibration:AUTO:MODE?	247
:CALibration:AUTO:TIME:OFF?	259
:CALibration:DATA:BACKup <filename>	268
:CALibration:DATA:DEFault	262
:CALibration:DATA:RESTore <filename>	268

List of Commands

:CALibration:EMIXer?	254
:CALibration:EMIXer	254
:CALibration:FREQuency:REFerence:COARse <integer>	271
:CALibration:FREQuency:REFerence:COARse?	271
:CALibration:FREQuency:REFerence:FINE <integer>	271
:CALibration:FREQuency:REFerence:FINE?	271
:CALibration:FREQuency:REFerence:MODE CALibrated USER	270
:CALibration:FREQuency:REFerence:MODE?	270
:CALibration:IQ:FLATness:I	1510
:CALibration:IQ:FLATness:I IBAR Q QBAR:TIME?	1514
:CALibration:IQ:FLATness:IBAR	1511
:CALibration:IQ:FLATness:Q	1512
:CALibration:IQ:FLATness:QBAR	1513
:CALibration:IQ:ISOLation	1508
:CALibration:IQ:ISOLation:TIME?	1509
:CALibration:IQ:PROBe:I	1515
:CALibration:IQ:PROBe:I IBAR Q QBAR:TIME?	1520
:CALibration:IQ:PROBe:I Q:CLEar	1466
:CALibration:IQ:PROBe:IBar	1517
:CALibration:IQ:PROBe:Q	1518
:CALibration:IQ:PROBe:QBar	1519
:CALibration:NRF?	252
:CALibration:NRF	252
:CALibration:RF?	253
:CALibration:RFPSelector:ALERt ON OFF 0 1	276
:CALibration:RFPSelector:ALERt?	276
:CALibration:RFPSelector:CONDUCTed?	272
:CALibration:RFPSelector:CONDUCTed	272
:CALibration:RFPSelector:FULL?	275
:CALibration:RFPSelector:FULL	275
:CALibration:RFPSelector:RADiated?	273

List of Commands

:CALibration:RFPSelector:RADiated	273
:CALibration:RFPSelector:SCHeDuler:RECurrence DAY WEEK OFF	278
:CALibration:RFPSelector:SCHeDuler:RECurrence?	278
:CALibration:RFPSelector:SCHeDuler:RECurrence:DAY SUN MON TUE WED THU FRI SAT	279
:CALibration:RFPSelector:SCHeDuler:RECurrence:DAY?	279
:CALibration:RFPSelector:SCHeDuler:RECurrence:WEEK <integer>	279
:CALibration:RFPSelector:SCHeDuler:RECurrence:WEEK?	279
:CALibration:RFPSelector:SCHeDuler:STATe ON OFF 0 1	280
:CALibration:RFPSelector:SCHeDuler:STATe?	280
:CALibration:RFPSelector:SCHeDuler:TASK T1 T2 T3	276
:CALibration:RFPSelector:SCHeDuler:TASK?	276
:CALibration:RFPSelector:SCHeDuler:TIME:NEXT?	260
:CALibration:RFPSelector:SCHeDuler:TIME:STARt "date","time"	277
:CALibration:RFPSelector:SCHeDuler:TIME:STARt?	277
:CALibration:RF	253
:CALibration:SOURce:STATe OFF ON 0 1	1467
:CALibration:SOURce:STATe?	1467
:CALibration:TEMPerature:CURRent?	256
:CALibration:TEMPerature:LALL?	257
:CALibration:TEMPerature:LPRe-selector?	258
:CALibration:TEMPerature:LRF?	257
:CALibration:TEMPerature:RFPSelector:LCONducted?	259
:CALibration:TEMPerature:RFPSelector:LRADiated?	259
:CALibration:TEMPerature:SOURce: LALL?	258
:CALibration:TIME:LALL?	256
:CALibration:TIME:LPRe-selector?	258
:CALibration:TIME:LRF?	257
:CALibration:TIME:RFPSelector:LCONducted?	259
:CALibration:TIME:RFPSelector:LRADiated?	259
:CALibration:TIME:SOURce:LALL?	257
:CALibration:YTF?	269

List of Commands

:CALibration:YTF	269
*CLS	173
:CONFigure:<Measurement>	189
:CONFigure?	1524
:CONFigure:ACP:NDEFault	457
:CONFigure:ACPower	539
:CONFigure:ACP	457
:CONFigure:CEVM:NDEFault	1339
:CONFigure:CEVM	1339
:CONFigure:CHPower	358
:CONFigure:CHPower:NDEFault	315
:CONFigure:CHPower	315
:CONFigure:EVM	843
:CONFigure:MONitor	1243
:CONFigure:MONitor:NDEFault	1217
:CONFigure:MONitor	1217
:CONFigure:OBWidth	430
:CONFigure:OBWidth:NDEFault	399
:CONFigure:OBWidth	399
:CONFigure:PSTatistic	601
:CONFigure:PSTatistic:NDEFault	577
:CONFigure:PSTatistic	577
:CONFigure:SEMask	784
:CONFigure:SEMask:NDEFault	697
:CONFigure:SEMask	697
:CONFigure:SPURious	667
:CONFigure:SPURious:NDEFault	621
:CONFigure:SPURious	621
:CONFigure:WAVEform	1319
:CONFigure:WAVEform:NDEFault	1269
:CONFigure:WAVEform	1269

List of Commands

:COUple ALL NONE	1412
Delta SS	1354
:DISPlay:<meas>:AFPoints OFF ON 0 1	1722
:DISPlay:<meas>:AFPoints?	1722
:DISPlay:<meas>:FANNotation CSPan SSTop	1723
:DISPlay:<meas>:FANNotation?	1723
:DISPlay:<meas>:TRACe[1] 2 3 4:COpy D1 D2 D3 D4 D5 D6	1753
:DISPlay:<meas>:TRACe[1] 2 3 4:DDEMod:ALIN?	1753
:DISPlay:<meas>:TRACe[1] 2 3 4:DDEMod:ALINe OFF ON 0 1	1753
:DISPlay:<meas>:TRACe[1] 2 3 4:DDEMod:EYE:COUNT <real>	1751
:DISPlay:<meas>:TRACe[1] 2 3 4:DDEMod:EYE:COUNT?	1751
:DISPlay:<meas>:TRACe[1] 2 3 4:DDEMod:SYMBOL BARS DOTS OFF	1749
:DISPlay:<meas>:TRACe[1] 2 3 4:DDEMod:SYMBOL?	1749
:DISPlay:<meas>:TRACe[1] 2 3 4:DDEMod:SYMBOL:FORMAt HEXadecimal BINary	1751
:DISPlay:<meas>:TRACe[1] 2 3 4:DDEMod:SYMBOL:FORMAt?	1751
:DISPlay:<meas>:TRACe[1] 2 3 4:DDEMod:SYMBOL:SHAPE CIRCLE CROSS OFF	1749
:DISPlay:<meas>:TRACe[1] 2 3 4:DDEMod:SYMBOL:SHAPE?	1749
:DISPlay:<meas>:TRACe[1] 2 3 4:DDEMod:SYMBOL:SIZE <real>	1750
:DISPlay:<meas>:TRACe[1] 2 3 4:DDEMod:SYMBOL:SIZE?	1750
:DISPlay:<meas>:TRACe[1] 2 3 4:DDEMod:UNIT:FREQuency CARRIER HZ	1752
:DISPlay:<meas>:TRACe[1] 2 3 4:DDEMod:UNIT:FREQuency?	1752
:DISPlay:<meas>:TRACe[1] 2 3 4:DDEMod:UNIT:TIME SEC SYMBOL	1752
:DISPlay:<meas>:TRACe[1] 2 3 4:DDEMod:UNIT:TIME?	1752
:DISPlay:<meas>:TRACe[1] 2 3 4:FEED <string>	1731
:DISPlay:<meas>:TRACe[1] 2 3 4:FEED?	1731
:DISPlay:<meas>:TRACe[1] 2 3 4:FORMAt MLOG MLINear REAL IMAGinary VECTor CONS PHASe UP- Hase EYE QEYE TRELlis GDElay MLGLinear	1748
:DISPlay:<meas>:TRACe[1] 2 3 4:FORMAt?	1748
:DISPlay:<meas>:TRACe[1] 2 3 4:FORMAt:DElay:APERture <real>	1757
:DISPlay:<meas>:TRACe[1] 2 3 4:FORMAt:DElay:APERture?	1757
:DISPlay:<meas>:TRACe[1] 2 3 4:FORMAt:PHASe:OFFSet <real>	1755

List of Commands

:DISPlay:<meas>:TRACe[1] 2 3 4:FORMat:PHASe:OFFSet?	1755
:DISPlay:<meas>:TRACe[1] 2 3 4:FORMat:PHASe:UNWRap: REFerence <real>	1756
:DISPlay:<meas>:TRACe[1] 2 3 4:FORMat:PHASe:UNWRap: REFerence?	1756
:DISPlay:<meas>:TRACe[1] 2 3 4:RLINe OFF ON 0 1 :DISPlay:<meas>:TRACe[1] 2 3 4:RLINe?	1664
:DISPlay:<meas>:TRACe[1] 2 3 4:VHCenter <real>	1663
:DISPlay:<meas>:TRACe[1] 2 3 4:VHCenter?	1663
:DISPlay:<meas>:TRACe[1] 2 3 4:X[:SCALe]:COUPLe OFF ON 0 1	1720
:DISPlay:<meas>:TRACe[1] 2 3 4:X[:SCALe]:COUPLe?	1720
:DISPlay:<meas>:TRACe[1] 2 3 4:X[:SCALe]:RLEVel <real>	1720
:DISPlay:<meas>:TRACe[1] 2 3 4:X[:SCALe]:RLEVel?	1720
:DISPlay:<meas>:TRACe[1] 2 3 4:X[:SCALe]:RPOStion LEFT CENTer RIGHT	1722
:DISPlay:<meas>:TRACe[1] 2 3 4:X[:SCALe]:RPOStion?	1722
:DISPlay:<meas>:TRACe[1] 2 3 4:X[:SCALe]:SPAN <real>	1721
:DISPlay:<meas>:TRACe[1] 2 3 4:X[:SCALe]:SPAN?	1721
:DISPlay:<meas>:TRACe[1] 2 3 4:Y:LRATio <real>	1662
:DISPlay:<meas>:TRACe[1] 2 3 4:Y:LRATio?	1662
:DISPlay:<meas>:TRACe[1] 2 3 4:Y[:SCALe]:AUTO:ONCE	1658
:DISPlay:<meas>:TRACe[1] 2 3 4:Y[:SCALe]:PDIVision <real>	1659
:DISPlay:<meas>:TRACe[1] 2 3 4:Y[:SCALe]:PDIVision?	1659
:DISPlay:<meas>:TRACe[1] 2 3 4:Y[:SCALe]:RLEVel <real>	1659
:DISPlay:<meas>:TRACe[1] 2 3 4:Y[:SCALe]:RLEVel?	1659
:DISPlay:<meas>:TRACe[1] 2 3 4:Y[:SCALe]:RLEVel:AUTO OFF ON 0 1	1660
:DISPlay:<meas>:TRACe[1] 2 3 4:Y[:SCALe]:RLEVel:AUTO?	1660
:DISPlay:<meas>:TRACe[1] 2 3 4:Y[:SCALe]:RPOStion TOP CENTer BOTTom	1661
:DISPlay:<meas>:TRACe[1] 2 3 4:Y[:SCALe]:RPOStion?	1661
:DISPlay:<meas>:TRACe[1] 2 3 4:Y:UNIT?	1662
:DISPlay:<meas>:TRACe[1] 2 3 4:Y:UNIT:PREFerence AUTO PEAK RMS POWER MRMS	1661
:DISPlay:<meas>:TRACe[1] 2 3 4:Y:UNIT:PREFerence?	1661
:DISPlay:<meas>:WINDow:FORMat SINGLE TWO TRI QUAD GR2X3 GR3X2	1788
:DISPlay:<meas>:WINDow:FORMat SINGLE TWO TRI QUAD	1788
:DISPlay:<meas>:WINDow:FORMat?	1788

List of Commands

:DISPlay:<meas>:WINDow:FORMat?	1788
:DISPlay:<measurement>:ANNotation:TITLe:DATA <string>	1650
:DISPlay:<measurement>:ANNotation:TITLe:DATA?	1650
:DISPlay:ACPower:VIEW[1]:WINDow[1]:BGRaph OFF ON 0 1	576
:DISPlay:ACPower:VIEW[1]:WINDow[1]:BGRaph?	576
:DISPlay:ACPower:VIEW[1]:WINDow[1]:TRACe:Y[:SCALe]:COUPle 0 1 OFF ON	473
:DISPlay:ACPower:VIEW[1]:WINDow[1]:TRACe:Y[:SCALe]:COUPle?	473
:DISPlay:ACPower:VIEW[1]:WINDow[1]:TRACe:Y[:SCALe]:PDIVision <rel_ampl>	471
:DISPlay:ACPower:VIEW[1]:WINDow[1]:TRACe:Y[:SCALe]:PDIVision?	471
:DISPlay:ACPower:VIEW[1]:WINDow[1]:TRACe:Y[:SCALe]:RLEVel <real>	470
:DISPlay:ACPower:VIEW[1]:WINDow[1]:TRACe:Y[:SCALe]:RLEVel?	470
:DISPlay:ACPower:VIEW[1]:WINDow[1]:TRACe:Y[:SCALe]:RPOStion TOP CENTer BOTTom	473
:DISPlay:ACPower:VIEW[1]:WINDow[1]:TRACe:Y[:SCALe]:RPOStion?	473
:DISPlay:ACPower:VIEW:NSElect <integer>	572
:DISPlay:ACPower:VIEW:NSElect?	572
:DISPlay:ACPower:VIEW[:SElect] PRESult CINFormation	572
:DISPlay:ACPower:VIEW[:SElect]?	572
:DISPlay:ACPower:VIEW:WINDow:CINFormation:FREQuency OFFSet ABSolute	575
:DISPlay:ACPower:VIEW:WINDow:CINFormation:FREQuency?	575
:DISPlay:ACTivefunc[:STATe] ON OFF 1 0	1649
:DISPlay:ACTivefunc[:STATe]?	1649
:DISPlay:ANNotation:MBAR[:STATe] OFF ON 0 1	1648
:DISPlay:ANNotation:MBAR[:STATe]?	1648
:DISPlay:ANNotation:SCReen[:STATe] OFF ON 0 1	1648
:DISPlay:ANNotation:SCReen[:STATe]?	1648
:DISPlay:ANNotation:TRACe[:STATe] ON OFF 1 0	1649
:DISPlay:ANNotation:TRACe[:STATe]?	1649
:DISPlay:BACKlight ON OFF	1654
:DISPlay:BACKlight?	1654
:DISPlay:BACKlight:INTensity <integer>	1654
:DISPlay:BACKlight:INTensity?	1654

List of Commands

:DISPlay:CEVM:VIEW[:SElect] MLISt PARAmeter RESult RFENvelope.....	1372
:DISPlay:CEVM:VIEW[:SElect]?	1372
:DISPlay:CHPower:VIEW[1]:WINDow[1]:BGRaph ON OFF 1 0.....	386
:DISPlay:CHPower:VIEW[1]:WINDow[1]:BGRaph?	386
:DISPlay:CHPower:VIEW[1]:WINDow[1]:TRACe:Y[:SCALe]:COUPlE 0 1 OFF ON	325
:DISPlay:CHPower:VIEW[1]:WINDow[1]:TRACe:Y[:SCALe]:COUPlE?.....	325
:DISPlay:CHPower:VIEW[1]:WINDow[1]:TRACe:Y[:SCALe]:PDIVision <rel_amp>	322
:DISPlay:CHPower:VIEW[1]:WINDow[1]:TRACe:Y[:SCALe]:PDIVision?	322
:DISPlay:CHPower:VIEW[1]:WINDow[1]:TRACe:Y[:SCALe]:RLEVel <real>	321
:DISPlay:CHPower:VIEW[1]:WINDow[1]:TRACe:Y[:SCALe]:RLEVel?	321
:DISPlay:CHPower:VIEW[1]:WINDow[1]:TRACe:Y[:SCALe]:RPOStion TOP CENTer BOTTom	324
:DISPlay:CHPower:VIEW[1]:WINDow[1]:TRACe:Y[:SCALe]:RPOStion?.....	324
:DISPlay:CHPower:VIEW:MASK[:SElect] LSNI GPNI IPNI GPA2 KSKP.....	395
:DISPlay:CHPower:VIEW:MASK[:SElect]?.....	395
:DISPlay:CHPower:VIEW:NSElect <integer>	382
:DISPlay:CHPower:VIEW:NSElect?	382
:DISPlay:CHPower:VIEW[:SElect] PRESult CINFormation	382
:DISPlay:CHPower:VIEW[:SElect] RFSPectrum SHOUlder MASK	382
:DISPlay:CHPower:VIEW[:SElect] RFSPectrum SHOUlder	383
:DISPlay:CHPower:VIEW[:SElect]?	382
:DISPlay:CHPower:VIEW[:SElect]?	382
:DISPlay:CHPower:VIEW[:SElect]?	383
:DISPlay:CHPower:VIEW:WINDow:CINFormation:FREQUency OFFSet ABSolute.....	386
:DISPlay:CHPower:VIEW:WINDow:CINFormation:FREQUency?.....	386
:DISPlay:ENABLe OFF ON 0 1	1656
:DISPlay:ENABLe?.....	1656
:DISPlay:EVM:VIEW:PRESet BASic.....	1210
:DISPlay:EVM:VIEW:PRESet BASic SUMMary RBSLot SUBCarrier MIMO.....	1210
:DISPlay:EVM:VIEW:PRESet MIMO	1215
:DISPlay:EVM:VIEW:PRESet RBSLot	1213
:DISPlay:EVM:VIEW:PRESet SUBCarrier	1214

List of Commands

:DISPlay:EVM:VIEW:PRESet SUMMary	1211
:DISPlay:FSCReen[:STATe] OFF ON 0 1	1655
:DISPlay:FSCReen[:STATe]?	1655
:DISPlay:MONitor:VIEW[1]:WINDow[1]:TRACe:Y[:SCALe]:COUPle 0 1 OFF ON	1220
:DISPlay:MONitor:VIEW[1]:WINDow[1]:TRACe:Y[:SCALe]:COUPle?	1220
:DISPlay:MONitor:VIEW[1]:WINDow[1]:TRACe:Y[:SCALe]:PDIVision <rel_amp>	1219
:DISPlay:MONitor:VIEW[1]:WINDow[1]:TRACe:Y[:SCALe]:PDIVision?	1219
:DISPlay:MONitor:VIEW[1]:WINDow[1]:TRACe:Y[:SCALe]:RLEVel <real>	1218
:DISPlay:MONitor:VIEW[1]:WINDow[1]:TRACe:Y[:SCALe]:RLEVel?	1218
:DISPlay:MONitor:VIEW[1]:WINDow[1]:TRACe:Y[:SCALe]:RPOSition TOP CENTer BOTTom	1220
:DISPlay:MONitor:VIEW[1]:WINDow[1]:TRACe:Y[:SCALe]:RPOSition?	1220
:DISPlay:MONitor:VIEW:NSElect <integer>	1265
:DISPlay:MONitor:VIEW:NSElect?	1265
:DISPlay:MONitor:VIEW[:SElect] RTRace CINFormation	1264
:DISPlay:MONitor:VIEW[:SElect]?	1264
:DISPlay:MONitor:VIEW:WINDow:CATTRIBUTE OFF ON 0 1	1268
:DISPlay:MONitor:VIEW:WINDow:CATTRIBUTE?	1268
:DISPlay:MONitor:VIEW:WINDow:CINFormation:FREQuency OFFSet ABSolute	1267
:DISPlay:MONitor:VIEW:WINDow:CINFormation:FREQuency?	1267
:DISPlay:MONitor:VIEW:WINDow:TRACe[1] 2 3:CLEar	1261
:DISPlay:OBWidth:VIEW[1]:WINDow[1]:TRACe:Y[:SCALe]:COUPle 0 1 OFF ON	405
:DISPlay:OBWidth:VIEW[1]:WINDow[1]:TRACe:Y[:SCALe]:COUPle?	405
:DISPlay:OBWidth:VIEW[1]:WINDow[1]:TRACe:Y[:SCALe]:PDIVision <rel_amp>	402
:DISPlay:OBWidth:VIEW[1]:WINDow[1]:TRACe:Y[:SCALe]:PDIVision?	402
:DISPlay:OBWidth:VIEW[1]:WINDow[1]:TRACe:Y[:SCALe]:RLEVel <real>	401
:DISPlay:OBWidth:VIEW[1]:WINDow[1]:TRACe:Y[:SCALe]:RLEVel?	401
:DISPlay:OBWidth:VIEW[1]:WINDow[1]:TRACe:Y[:SCALe]:RPOSition TOP CENTer BOTTom	404
:DISPlay:OBWidth:VIEW[1]:WINDow[1]:TRACe:Y[:SCALe]:RPOSition?	404
:DISPlay:PStatistic:GAUSSian[:STATe] OFF ON 0 1	613
:DISPlay:PStatistic:GAUSSian[:STATe]?	613
:DISPlay:PStatistic:RTRace[:STATe] OFF ON 0 1	612

List of Commands

:DISPlay:PStatistic:RTRace[:STATe]?	612
:DISPlay:PStatistic:VIEW[1]:WINDow2:TRACe:X[:SCALe]:PDIVision <rel_amp>	610
:DISPlay:PStatistic:VIEW[1]:WINDow2:TRACe:X[:SCALe]:PDIVision?	610
:DISPlay:SEMAsk:VIEW[1]:WINDow[1]:TRACe:Y[:SCALe]:COUPlE 0 1 ON OFF	729
:DISPlay:SEMAsk:VIEW[1]:WINDow[1]:TRACe:Y[:SCALe]:COUPlE?	729
:DISPlay:SEMAsk:VIEW[1]:WINDow[1]:TRACe:Y[:SCALe]:PDIVision <rel_amp>	727
:DISPlay:SEMAsk:VIEW[1]:WINDow[1]:TRACe:Y[:SCALe]:PDIVision?	727
:DISPlay:SEMAsk:VIEW[1]:WINDow[1]:TRACe:Y[:SCALe]:RLEVel <real>	726
:DISPlay:SEMAsk:VIEW[1]:WINDow[1]:TRACe:Y[:SCALe]:RLEVel?	726
:DISPlay:SEMAsk:VIEW[1]:WINDow[1]:TRACe:Y[:SCALe]:RPOSition TOP CENTer BOTTom.	729
:DISPlay:SEMAsk:VIEW[1]:WINDow[1]:TRACe:Y[:SCALe]:RPOSition?	729
:DISPlay:SEMAsk:VIEW:NSElect <integer>	816
:DISPlay:SEMAsk:VIEW:NSElect?	816
:DISPlay:SEMAsk:VIEW[:SElect] APFReq RPFReq IPOWER CINFormation	816
:DISPlay:SEMAsk:VIEW[:SElect]?	816
:DISPlay:SEMAsk:VIEW:WINDow:CINFormation:FREQuency OFFSet ABSolute.	840
:DISPlay:SEMAsk:VIEW:WINDow:CINFormation:FREQuency?	840
:DISPlay:SPURious:VIEW[1]:WINDow[1]:TRACe:Y[:SCALe]:COUPlE 0 1 OFF ON	626
:DISPlay:SPURious:VIEW[1]:WINDow[1]:TRACe:Y[:SCALe]:COUPlE?	626
:DISPlay:SPURious:VIEW[1]:WINDow[1]:TRACe:Y[:SCALe]:PDIVision <rel_amp>	624
:DISPlay:SPURious:VIEW[1]:WINDow[1]:TRACe:Y[:SCALe]:PDIVision?	624
:DISPlay:SPURious:VIEW[1]:WINDow[1]:TRACe:Y[:SCALe]:RLEVel <real>	623
:DISPlay:SPURious:VIEW[1]:WINDow[1]:TRACe:Y[:SCALe]:RLEVel?	623
:DISPlay:SPURious:VIEW:RANGe[:SElect] <integer>	643
:DISPlay:SPURious:VIEW:RANGe[:SElect]?	643
:DISPlay:SPURious:VIEW:RANGe:TABLE <integer>	694
:DISPlay:SPURious:VIEW:RANGe:TABLE?	694
:DISPlay:SPURious:VIEW[:SElect] RESult RANGe	691
:DISPlay:SPURious:VIEW[:SElect]?	691
:DISPlay:THEME TDColor TDMonochrome FCOLOR FMONochrome	1653
:DISPlay:THEME?	1653

List of Commands

:DISPlay:WAVeform:VIEW[1] 2:WINDow[1]:TRACe:X[:SCALe]:COUPle 0 1 OFF ON	1331
:DISPlay:WAVeform:VIEW[1] 2:WINDow[1]:TRACe:X[:SCALe]:COUPle?	1331
:DISPlay:WAVeform:VIEW[1] 2:WINDow[1]:TRACe:X[:SCALe]:PDIVision <time>	1330
:DISPlay:WAVeform:VIEW[1] 2:WINDow[1]:TRACe:X[:SCALe]:PDIVision?	1330
:DISPlay:WAVeform:VIEW[1] 2:WINDow[1]:TRACe:X[:SCALe]:RLEVel <time>	1329
:DISPlay:WAVeform:VIEW[1] 2:WINDow[1]:TRACe:X[:SCALe]:RLEVel?	1329
:DISPlay:WAVeform:VIEW[1] 2:WINDow[1]:TRACe:X[:SCALe]:RPOStion LEFT CENTer RIGHT	1330
:DISPlay:WAVeform:VIEW[1] 2:WINDow[1]:TRACe:X[:SCALe]:RPOStion?	1330
:DISPlay:WAVeform:VIEW[1] 2:WINDow[1]:TRACe:Y[:SCALe]:COUPle 0 1 OFF ON	1277
:DISPlay:WAVeform:VIEW[1] 2:WINDow[1]:TRACe:Y[:SCALe]:COUPle?	1277
:DISPlay:WAVeform:VIEW[1]:WINDow[1]:TRACe:Y[:SCALe]:PDIVision <rel_ampl>	1273
:DISPlay:WAVeform:VIEW[1]:WINDow[1]:TRACe:Y[:SCALe]:PDIVision?	1273
:DISPlay:WAVeform:VIEW[1]:WINDow[1]:TRACe:Y[:SCALe]:RLEVel <ampl>	1271
:DISPlay:WAVeform:VIEW[1]:WINDow[1]:TRACe:Y[:SCALe]:RLEVel?	1271
:DISPlay:WAVeform:VIEW[1]:WINDow[1]:TRACe:Y[:SCALe]:RPOStion TOP CENTer BOTTom	1276
:DISPlay:WAVeform:VIEW[1]:WINDow[1]:TRACe:Y[:SCALe]:RPOStion?	1276
:DISPlay:WAVeform:VIEW2:WINDow[1]:TRACe:Y[:SCALe]:PDIVision <voltage>.	1274
:DISPlay:WAVeform:VIEW2:WINDow[1]:TRACe:Y[:SCALe]:PDIVision?	1274
:DISPlay:WAVeform:VIEW2:WINDow[1]:TRACe:Y[:SCALe]:RLEVel <voltage>	1272
:DISPlay:WAVeform:VIEW2:WINDow[1]:TRACe:Y[:SCALe]:RLEVel?	1272
:DISPlay:WAVeform:VIEW2:WINDow[1]:TRACe:Y[:SCALe]:RPOStion TOP CENTer BOTTom.	1276
:DISPlay:WAVeform:VIEW2:WINDow[1]:TRACe:Y[:SCALe]:RPOStion?	1276
:DISPlay:WAVeform:VIEW:NSElect <integer>	1335
:DISPlay:WAVeform:VIEW:NSElect?	1335
:DISPlay:WAVeform:VIEW[:SElect] RFENvelope IQ	1335
:DISPlay:WAVeform:VIEW[:SElect]?	1335
:DISPlay:WINDow[1]:ANNotation[:ALL] OFF ON 0 1.	1653
:DISPlay:WINDow[1]:ANNotation[:ALL]?	1653
:DISPlay:WINDow[1]:TRACe:GRATicule:GRID[:STATe] OFF ON 0 1.	1651
:DISPlay:WINDow[1]:TRACe:GRATicule:GRID[:STATe]?	1651
:DISPlay:WINDow[1]:TRACe:Y:DLINe <ampl>	1652

List of Commands

:DISPlay:WINDow[1]:TRACe:Y:DLINe?	1652
:DISPlay:WINDow[1]:TRACe:Y:DLINe:STATe OFF ON 0 1	1652
:DISPlay:WINDow[1]:TRACe:Y:DLINe:STATe?	1652
:DISPlay:WINDow[1]:TRACe:Y[:SCALe]:PDIVision <rel_ampl>	1395
:DISPlay:WINDow[1]:TRACe:Y[:SCALe]:PDIVision?	1395
:DISPlay:WINDow[1]:TRACe:Y[:SCALe]:RLEVel <real>	1379
:DISPlay:WINDow[1]:TRACe:Y[:SCALe]:RLEVel?	1379
:DISPlay:WINDow[1]:TRACe:Y[:SCALe]:RLEVel:OFFSet <rel_ampl>	1404
:DISPlay:WINDow[1]:TRACe:Y[:SCALe]:RLEVel:OFFSet?	1404
:DISPlay:WINDow[1]:TRACe:Y[:SCALe]:SPACing LINear LOGarithmic	1396
:DISPlay:WINDow[1]:TRACe:Y[:SCALe]:SPACing?	1396
:DISPlay:WINDow:FORMat:TILE	161
:DISPlay:WINDow:FORMat:ZOOM	161
:DISPlay:WINDow[:SElect] <number>	161
:DISPlay:WINDow[:SElect]?	161
Equalizer Training	1355
*ESE <integer>	174
*ESE?	174
*ESR?	174
:FETCh:<meas>[n]?	1789
:FETCh:ACP[n]?	457
:FETCh:CEVM[n]?	1339
:FETCh:CHPower:CHPower?	315
:FETCh:CHPower:DENSity?	315
:FETCh:CHPower[n]?	315
:FETCh:EVM[n]?	843
:FETCh:FCAPture?	1806
:FETCh:MONitor[n]?	1217
:FETCh:OBWidth [n]?	399
:FETCh:OBWidth:FERRor?	399
:FETCh:OBWidth:OBWidth?	399

List of Commands

:FETCh:OBWidth:XDB?	399
:FETCh:PSTatistic[n]?	577
:FETCh:SEMask[n]?	697
:FETCh:SPURious[n]?	621
:FETCh:WAVeform[n]	1269
:FORMat:BORDer NORMAl SWAPped	1534
:FORMat:BORDer?	1534
:FORMat[:TRACe][:DATA] ASCii INTegeR,32 REAL,32 REAL,64.	1532
:FORMat[:TRACe][:DATA]?	1532
Frequency Hopping	1355
:GLOBal:FREQuency:CENTer[:STATe] 1 0 ON OFF.	1552
:GLOBal:FREQuency:CENTer[:STATe]?	1552
Group Hopping	1355
:HCOPy:ABORt.	191
:HCOPy[:IMMediate]	191
*IDN?	175
Include PUSCH DMRS	1354
Include PUSCH	1354
INCLude.	1354
INCLude.	1354
:INITiate:ACP	457
:INITiate:CEVM	1339
:INITiate:CHPower	315
:INITiate:CONTinuous OFF ON 0 1	1413
:INITiate:CONTinuous?	1413
:INITiate:EVM.	843
:INITiate:FCAPture	1805
:INITiate[:IMMediate]	1558
:INITiate:MONitor.	1217
:INITiate:OBWidth	399
:INITiate:PAUSE	1577

List of Commands

:INITiate:PSStatistic	577
:INITiate:REStart	1558
:INITiate:RESume	1577
:INITiate:SEMAsk	697
:INITiate:SPURious	621
:INITiate:WAVeform	1269
:INPut[1]:IQ:BALEnced[:STATe] OFF ON 0 1	1456
:INPut[1]:IQ:BALEnced[:STATe]?	1456
:INPut[1]:IQ[:I]:IMPedance LOW HIGH	1457
:INPut[1]:IQ[:I]:IMPedance?	1457
:INPut[1]:IQ:Q:IMPedance LOW HIGH	1461
:INPut[1]:IQ:Q:IMPedance?	1461
:INPut[1]:IQ:TYPE IQ IQ	1454
:INPut[1]:IQ:TYPE?	1454
:INPut:COUPling AC DC	1426
:INPut:COUPling?	1426
:INPut:COUPling:I Q DC LFR1 LFR2	1464
:INPut:COUPling:I Q?	1464
:INPut:IMPedance:IQ U50 B50 U1M B1M	1458
:INPut:IMPedance:IQ?	1458
:INPut:IMPedance:REFErence <integer>	1466
:INPut:IMPedance:REFErence?	1466
:INPut:IQ[:I]:DIFFErential OFF ON 0 1	1456
:INPut:IQ[:I]:DIFFErential?	1456
:INPut:IQ:MIRROred OFF ON 0 1	1459
:INPut:IQ:MIRROred?	1459
:INPut:IQ:Q:DIFFErential OFF ON 0 1	1460
:INPut:IQ:Q:DIFFErential?	1460
:INPut:MIXer EXTErnal INTErnal	1424
:INPut:MIXer?	1424
:INPut:OFFSet:I Q <voltage>	1464

List of Commands

:INPut:OFFSet:I Q?	1464
:INSTrument:CATalog?	1538
:INSTrument:COUPle:DEFault	1553
:INSTrument:COUPle:FREQuency:CENTer ALL NONE	1552
:INSTrument:COUPle:FREQuency:CENTer?	1552
:INSTrument:DEFault	188
:INSTrument:NSElect <integer>	1538
:INSTrument:NSElect?	1538
:INSTrument[:SElect] SA SEQAN EMI BASIC WCDMA EDGE GSM WIMAX OFDMA VSA PNOISE NFIGURE ADEMOD BT TDSC DMA CDMA2K CDMA1X EV LTE LTETDD DVB DTMB DCATV ISDBT CMMB CWLAN CWIMAXOFDM WIMAXFIXED IDEN RLC SCPILC VSA89601	1534
:INSTrument[:SElect]?	1534
:LXI:EVENT:DOMain <intDomain>	301
:LXI:EVENT:DOMain?	301
:LXI:EVENT:LOG:ALL?	234
:LXI:EVENT:LOG:CIRCular[:ENABle] ON OFF 1 0	232
:LXI:EVENT:LOG:CIRCular[:ENABle]?	232
:LXI:EVENT:LOG:CIRCular:FBENtry	234
:LXI:EVENT:LOG:CLEar	232
:LXI:EVENT:LOG:COUNt?	233
:LXI:EVENT:LOG:ENABle ON OFF 1 0	233
:LXI:EVENT:LOG:ENABle?	233
:LXI:EVENT:LOG:ENTRy? <intIndex>	234
:LXI:EVENT:LOG[:NEXT]?	233
:LXI:EVENT:LOG:SIZE <size>	232
:LXI:EVENT:LOG:SIZE?	232
:LXI:EVENT[:OUTPut]:LAN:ADD "LANEVENT"	302
:LXI:EVENT[:OUTPut]:LAN:COUNt?	307
:LXI:EVENT[:OUTPut]:LAN:DISable:ALL	301
:LXI:EVENT[:OUTPut]:LAN:LIST?	302
:LXI:EVENT[:OUTPut]:LAN:REMOve:ALL	303

List of Commands

:LXI:EVENT[:OUTPut]:LAN:REMOve[:EVENT] "LANEVENT"	303
:LXI:EVENT[:OUTPut]:LAN:SEND "LANEVENT", RISE FALL	308
:LXI:EVENT[:OUTPut]:LAN[:SET]:CONFigure "lanEvent",<enabled>,<source>,<slope>,<drive>,<destination> 308	
:LXI:EVENT[:OUTPut]:LAN[:SET]:DESTination "LANEVENT", "destinationExpression"	305
:LXI:EVENT[:OUTPut]:LAN[:SET]:DESTination? "LANEVENT"	305
:LXI:EVENT[:OUTPut]:LAN[:SET]:DRIVE "LANEVENT", OFF NORMal WOR	305
:LXI:EVENT[:OUTPut]:LAN[:SET]:DRIVE? "LANEVENT"	305
:LXI:EVENT[:OUTPut]:LAN[:SET]:ENABled "LANEVENT", ON OFF 1 0	307
:LXI:EVENT[:OUTPut]:LAN[:SET]:ENABled? "LANEVENT"	307
:LXI:EVENT[:OUTPut]:LAN[:SET]:IDENtifier "LANEVENT", "identifier"	308
:LXI:EVENT[:OUTPut]:LAN[:SET]:IDENtifier? "LANEVENT"	308
:LXI:EVENT[:OUTPut]:LAN[:SET]:SLOPe "LANEVENT", POSitive NEGative	306
:LXI:EVENT[:OUTPut]:LAN[:SET]:SLOPe? "LANEVENT"	306
:LXI:EVENT[:OUTPut]:LAN[:SET]:SOURce "LANEVENT", "SourceEvent"	304
:LXI:EVENT[:OUTPut]:LAN[:SET]:SOURce? "LANEVENT"	304
:LXI:EVENT[:OUTPut]:LAN[:SET]:TSDelta "LANEVENT", <seconds>	307
:LXI:EVENT[:OUTPut]:LAN[:SET]:TSDelta? "LANEVENT"	307
:MEASure:ACP[n]?	457
:MEASure:CEVM[n]?	1339
:MEASure:CHPower:CHPower?	315
:MEASure:CHPower:DENSity?	315
:MEASure:CHPower[n]?	315
:MEASure:EVM[n]?	843
:MEASure:MONitor[n]?	1217
:MEASure:OBWidth [n]?	399
:MEASure:OBWidth:FERRor?	399
:MEASure:OBWidth:OBWidth?	399
:MEASure:OBWidth:XDB?	399
:MEASure:PSTatistic[n]?	577
:MEASure:SEMAsk[n]?	697

List of Commands

:MEASure:SPURious[n]?	621
:MEASure:WAVEform[n].....	1269
:MEMMory:RDIRectory <directory_name>.....	224
:MEMMory:CATalog? [<directory_name>]	222
:MEMMory:CDIRectory [<directory_name>]	222
:MEMMory:CDIRectory?	222
:MEMMory:COpy <string>,<string>[,<string>,<string>]	222
:MEMMory:DATA <file_name>, <data>	223
:MEMMory:DATA? <file_name>	223
:MEMMory:DELete <file_name>[,<directory_name>]	223
MEMMory:LOAD:EVMSetup <string>.....	203
MEMMory:LOAD:MASK <string>	202
MEMMory:LOAD:SSSetup <string>	200
:MEMMory:LOAD:STATe <filename>.....	197
:MEMMory:LOAD:TRACe:DATA D1 D2 D3 D4 D5 D6,<filename>[,<CSV TXT SDF MAT4 MAT HDF5 BIN>] .. 1711	
MEMMory:LOAD:VSASetup <string>	200
:MEMMory:MDIRectory <directory_name>	224
:MEMMory:MOVE <string>,<string>[,<string>,<string>]	224
:MEMMory:STORE:CORRection 1 2 3 4 5 6, <filename>	1560
:MEMMory:STORE:SCReen <filename>	219
:MEMMory:STORE:SCReen:THEMe TDCOLOR TDMonochrome FCOLOR FMONochrome.....	217
:MEMMory:STORE:SCReen:THEMe?.....	217
:MEMMory:STORE:STATe <filename>	210
:MEMMory:STORE:TRACe TRACE1 TRACE2 TRACE3 TRACE4 TRACE5 TRACE6 ALL,<filename> ...	213
:MEMMory:STORE:TRACe:DATA TRACE1 TRACE2 TRACE3 TRACE4 TRACE5 TRACE6,"<filename>" [,<CSV TXT SDF MAT4 MAT HDF5 BIN ,OFF ON 0 1>]	1714
:MEMMory:STORE:TRACe:REGister TRACE1 TRACE2 TRACE3 TRACE4 TRACE5 TRACE6 ALL,<integer> 213	
OFF	1355
OFF	1355
ON	1354

List of Commands

*OPC?	175
*OPC	175
*OPT?	176
:OUTPut:ANALog OFF SVIDeo LOGVideo LINVideo DAUDio	1498
:OUTPut:ANALog?	1498
OUTPut:ANALog:AUTO OFF ON 0 1	1499
OUTPut:ANALog:AUTO?	1499
:OUTPut:AUX SIF AIF LOGVideo OFF	1506
:OUTPut:AUX?	1506
:OUTPut:AUX:AIF <value>	1507
:OUTPut:AUX:AIF?	1507
:OUTPut:DBUS[1][:STATe] ON OFF 1 0	1505
:OUTPut:DBUS[1][:STATe]?	1505
:OUTPut:IQ:OUTPut IQ1 IQ250 OFF	1504
:OUTPut:IQ:OUTPut?	1504
PUSCH Active	1354
PUSCH Auto Calc Params	1354
PUSCH Common Mod Type	1355
PUSCH Common RB End	1354
PUSCH End RB Couple	1354
PUSCH n DMRS (1)	1354
PUSCH n DMRS (2)	1354
PUSCH Start RB Couple	1354
PUSCH Sync Slot Auto	1355
PUSCH Sync Slot	1355
*RCL <register #>	177
:READ:<meas>[n]?	1789
:READ:ACP[n]?	457
:READ:CEVM[n]?	1339
:READ:CHPower:CHPower?	315
:READ:CHPower:DENSity	315

List of Commands

:READ:CHPower[n]?	315
:READ:EVM[n]?	843
:READ:MONitor[n]?	1217
:READ:OBWidth [n]?	399
:READ:OBWidth:FERRor?	399
:READ:OBWidth:OBWidth?	399
:READ:OBWidth:XDB?	399
:READ:PStatistic[n]?	577
:READ:SEMAsk[n]?	697
:READ:SPURious[n]?	621
:READ:WAVeform[n]	1269
RSData	1355
*RST	190
Same as Normal Mode	1354
Same as Normal Mode	1354
Same as Normal Mode	1354
Same as Normal Mode	1354
Same as Normal Mode	1354
Same as Normal Mode	1354
Same as Normal Mode	1354
Same as Normal Mode	1354
Same as Normal Mode	1354
Same as Normal Mode	1354
Same as Normal Mode	1355
Same as Normal Mode	1355
Same as Normal Mode	1355
Same as Normal Mode	1355
*SAV <register #>	177
[:SENSe]:<meas>:AVERAge:COUNT <integer>	1698
[:SENSe]:<meas>:AVERAge:COUNT?	1698
[:SENSe]:<meas>:AVERAge:FAST OFF ON 0 1	1700
[:SENSe]:<meas>:AVERAge:FAST?	1700

List of Commands

[[:SENSe]]:<meas>:AVERage:FAST:URATe <integer>	1701
[[:SENSe]]:<meas>:AVERage:FAST:URATe?	1701
[[:SENSe]]:<meas>:AVERage:FAST:URATe:AUTO OFF ON 0 1	1701
[[:SENSe]]:<meas>:AVERage:FAST:URATe:AUTO?	1701
[[:SENSe]]:<meas>:AVERage[:STATe] OFF ON 0 1	1698
[[:SENSe]]:<meas>:AVERage[:STATe]?	1698
[[:SENSe]]:<meas>:AVERage:TCONtrol EXPONential REPeat	1699
[[:SENSe]]:<meas>:AVERage:TCONtrol?	1699
[[:SENSe]]:<meas>:AVERage:TYPE RMS TIME MAXimum	1700
[[:SENSe]]:<meas>:AVERage:TYPE?	1700
[[:SENSe]]:<meas>:BANDwidth BWIDth[:RESolution] <bandwidth>	1665
[[:SENSe]]:<meas>:BANDwidth BWIDth[:RESolution]?	1665
[[:SENSe]]:<meas>:BANDwidth BWIDth[:RESolution]:COUple SPAN MIN FIXed	1666
[[:SENSe]]:<meas>:BANDwidth BWIDth[:RESolution]:COUple?	1666
[[:SENSe]]:<meas>:FFT:WINDow[:TYPE] UNIFORM HANNing GAUSSian FLATtop	1667
[[:SENSe]]:<meas>:FFT:WINDow[:TYPE]?	1667
[[:SENSe]]:<meas>:FREQuency:SYNThesis[:STATe] 1 2	1701
[[:SENSe]]:<meas>:FREQuency:SYNThesis[:STATe]?	1701
[[:SENSe]]:<meas>:PUPDate:ENABLE OFF ON 0 1	1808
[[:SENSe]]:<meas>:PUPDate:ENABLE?	1808
[[:SENSe]]:<meas>:SWEep:EGATe:DELay <time>	1727
[[:SENSe]]:<meas>:SWEep:EGATe:DELay?	1727
[[:SENSe]]:<meas>:SWEep:EGATe[:SPAN] <time>	1726
[[:SENSe]]:<meas>:SWEep:EGATe[:SPAN]?	1726
[[:SENSe]]:<meas>:SWEep:EGATe:STATe OFF ON 0 1	1726
[[:SENSe]]:<meas>:SWEep:EGATe:STATe?	1726
[[:SENSe]]:<meas>:SWEep:ISRate?	1807
[[:SENSe]]:<meas>:SWEep:POINts <integer>	1728
[[:SENSe]]:<meas>:SWEep:POINts?	1728
[[:SENSe]]:<meas>:SWEep:POINts:AUTO OFF ON 0 1	1728
[[:SENSe]]:<meas>:SWEep:POINts:AUTO?	1728

List of Commands

[[:SENSe]:<meas>:SWEep:TIME <time>	1725
[[:SENSe]:<meas>:SWEep:TIME?.	1725
[[:SENSe]:<measurement>:TRIGger:SOURce IF	1597
[[:SENSe]:<measurement>:TRIGger:SOURce.	1597
[[:SENSe]:ACPower:AVERage:COUNt <integer>	494
[[:SENSe]:ACPower:AVERage:COUNt?.	494
[[:SENSe]:ACPower:AVERage[:STATe] OFF ON 0 1	494
[[:SENSe]:ACPower:AVERage[:STATe]?	494
[[:SENSe]:ACPower:AVERage:TCONtrol EXPonential REPeat.	495
[[:SENSe]:ACPower:AVERage:TCONtrol?	495
[[:SENSe]:ACPower:BANDwidth[:RESolution] <bandwidth>.	476
[[:SENSe]:ACPower:BANDwidth[:RESolution]?	476
[[:SENSe]:ACPower:BANDwidth[:RESolution]:AUTO ON OFF 1 0.	476
[[:SENSe]:ACPower:BANDwidth[:RESolution]:AUTO?	476
[[:SENSe]:ACPower:BANDwidth:SHAPE GAUSSian FLATop.	479
[[:SENSe]:ACPower:BANDwidth:SHAPE?	479
[[:SENSe]:ACPower:BANDwidth:TYPE DB3 DB6	480
[[:SENSe]:ACPower:BANDwidth:TYPE?.	480
[[:SENSe]:ACPower:BANDwidth:VIDeo <freq>	477
[[:SENSe]:ACPower:BANDwidth:VIDeo?	477
[[:SENSe]:ACPower:BANDwidth:VIDeo:AUTO OFF ON 0 1.	477
[[:SENSe]:ACPower:BANDwidth:VIDeo:AUTO?	477
[[:SENSe]:ACPower:CARRier[1] 2:AUTO[:STATe] OFF ON 0 1.	499
[[:SENSe]:ACPower:CARRier[1] 2:AUTO[:STATe]?	499
[[:SENSe]:ACPower:CARRier[1] 2:COUNt <integer>	496
[[:SENSe]:ACPower:CARRier[1] 2:COUNt?	496
[[:SENSe]:ACPower:CARRier[1] 2:CPSD <real>.	500
[[:SENSe]:ACPower:CARRier[1] 2:CPSD?.	500
[[:SENSe]:ACPower:CARRier[1] 2:LIST:BANDwidth[:INTegration] <freq>, <freq>, <freq>, <freq>, <freq>, <freq>.	505
[[:SENSe]:ACPower:CARRier[1] 2:LIST:BANDwidth[:INTegration]?	505

List of Commands

[:SENSe]:ACPower:CARRier[1]2:LIST:COUPle OFF ON 0 1, OFF ON 0 1, OFF ON 0 1, OFF ON 0 1, OFF ON 0 1, OFF ON 0 1	501
[:SENSe]:ACPower:CARRier[1]2:LIST:COUPle?	501
[:SENSe]:ACPower:CARRier[1]2:LIST:FILTer:ALPHa <real>, <real>, <real>, <real>, <real>, <real>	507
[:SENSe]:ACPower:CARRier[1]2:LIST:FILTer:ALPHa?	507
[:SENSe]:ACPower:CARRier[1]2:LIST:FILTer[:RRC][:STATe] ON OFF 1 0, ON OFF 1 0, ON OFF 1 0, ON OFF 1 0, ON OFF 1 0, ON OFF 1 0	506
[:SENSe]:ACPower:CARRier[1]2:LIST:FILTer[:RRC][:STATe]?	506
[:SENSe]:ACPower:CARRier[1]2:LIST:METHod IBW RRC,	541
[:SENSe]:ACPower:CARRier[1]2:LIST:METHod?	541
[:SENSe]:ACPower:CARRier[1]2:LIST:PPResent YES NO, YES NO, YES NO, YES NO, YES NO, YES NO	502
[:SENSe]:ACPower:CARRier[1]2:LIST:PPResent?	502
[:SENSe]:ACPower:CARRier[1]2:LIST:WIDTh <bandwidth>, <bandwidth>, <bandwidth>, <bandwidth>, <bandwidth>, <bandwidth>	503
[:SENSe]:ACPower:CARRier[1]2:LIST:WIDTh?	503
[:SENSe]:ACPower:CARRier[1]2[:POWer] <real>	499
[:SENSe]:ACPower:CARRier[1]2[:POWer]?	499
[:SENSe]:ACPower:CARRier[1]2:RCARrier <integer>	496
[:SENSe]:ACPower:CARRier[1]2:RCARrier?	496
[:SENSe]:ACPower:CARRier[1]2:RCARrier:AUTO OFF ON 0 1	496
[:SENSe]:ACPower:CARRier[1]2:RCARrier:AUTO?	496
[:SENSe]:ACPower:CARRier[1]2:RCFRequency <freq>	497
[:SENSe]:ACPower:CARRier[1]2:RCFRequency?	497
[:SENSe]:ACPower:CARRier[1]2:RCFRequency:AUTO OFF ON 0 1	497
[:SENSe]:ACPower:CARRier[1]2:RCFRequency:AUTO?	497
[:SENSe]:ACPower:CARRier:INDex <integer>	509
[:SENSe]:ACPower:CARRier:INDex?	509
[:SENSe]:ACPower:CARRier:PREFeRence:TYPE LRCarriers MPCarrier CINDex MANual	508
[:SENSe]:ACPower:CARRier:PREFeRence:TYPE?	508
[:SENSe]:ACPower:CORRection:NOISe[:AUTO] OFF ON 0 1	539
[:SENSe]:ACPower:CORRection:NOISe[:AUTO]?	539
[:SENSe]:ACPower:DETEctor:AUTO ON OFF 1 0	564

List of Commands

[[:SENSe]:ACPower:DETEctor:AUTO?	564
[[:SENSe]:ACPower:DETEctor[:FUNction] AVERAge NEGative NORMal POSitive SAMPLE	565
[[:SENSe]:ACPower:DETEctor[:FUNction]?	565
[[:SENSe]:ACPower:FILTer[:RRC]:ALPHa <real>	540
[[:SENSe]:ACPower:FILTer[:RRC]:ALPHa?	540
[[:SENSe]:ACPower:FILTer[:RRC][:STATe] OFF ON 0 1	539
[[:SENSe]:ACPower:FILTer[:RRC][:STATe]?	539
[[:SENSe]:ACPower:FREQuency:SPAN <freq>	553
[[:SENSe]:ACPower:FREQuency:SPAN?	553
[[:SENSe]:ACPower:FREQuency:SPAN:FULL	554
[[:SENSe]:ACPower:FREQuency:SPAN:PREVious	555
[[:SENSe]:ACPower:FREQuency:SYNThesis:AUTO[:STATe] OFF ON 0 1	533
[[:SENSe]:ACPower:FREQuency:SYNThesis:AUTO[:STATe]?	533
[[:SENSe]:ACPower:FREQuency:SYNThesis[:STATe] 1 2 3	533
[[:SENSe]:ACPower:FREQuency:SYNThesis[:STATe]?	533
[[:SENSe]:ACPower:METHod IBW IBWRange FAST RBW	535
[[:SENSe]:ACPower:METHod?	535
[[:SENSe]:ACPower:OFFSet[1] 2:LIST:ABSolute <real>, <real>, <real>, <real>, <real>, <real>	520
[[:SENSe]:ACPower:OFFSet[1] 2:LIST:ABSolute?	520
[[:SENSe]:ACPower:OFFSet[1] 2:LIST:BANDwidth[:INTegration] <bandwidth>, <bandwidth>, <bandwidth>, <bandwidth>, <bandwidth>, <bandwidth>	513
[[:SENSe]:ACPower:OFFSet[1] 2:LIST:BANDwidth[:INTegration]?	513
[[:SENSe]:ACPower:OFFSet[1] 2:LIST:BANDwidth:RESolution <bandwidth>, <bandwidth>, <bandwidth>, <bandwidth>, <bandwidth>, <bandwidth>	515
[[:SENSe]:ACPower:OFFSet[1] 2:LIST:BANDwidth:RESolution?	515
[[:SENSe]:ACPower:OFFSet[1] 2:LIST:BANDwidth:RESolution:AUTO ON OFF 1 0, ON OFF 1 0, ON OFF 1 0, ON OFF 1 0, ON OFF 1 0, ON OFF 1 0	515
[[:SENSe]:ACPower:OFFSet[1] 2:LIST:BANDwidth:RESolution:AUTO?	515
[[:SENSe]:ACPower:OFFSet[1] 2:LIST:BANDwidth:SHAPE GAUSSian FLATtop, GAUSSian FLATtop, GAUSSian FLATtop, GAUSSian FLATtop, GAUSSian FLATtop, GAUSSian FLATtop	519
[[:SENSe]:ACPower:OFFSet[1] 2:LIST:BANDwidth:SHAPE?	519
[[:SENSe]:ACPower:OFFSet[1] 2:LIST:BANDwidth:TYPE DB3 DB6, DB3 DB6, DB3 DB6, DB3 DB6, DB3 DB6, DB3 DB6	519

List of Commands

[[:SENSe]:ACPower:OFFSet[1] 2:LIST:BANDwidth:TYPE?	519
[[:SENSe]:ACPower:OFFSet[1] 2:LIST:BANDwidth:VIDeo <freq>, <freq>, <freq>, <freq>, <freq>, <freq> ..	517
[[:SENSe]:ACPower:OFFSet[1] 2:LIST:BANDwidth:VIDeo?	517
[[:SENSe]:ACPower:OFFSet[1] 2:LIST:BANDwidth:VIDeo:AUTO OFF ON 0 1, OFF ON 0 1, OFF ON 0 1, OFF ON 0 1, OFF ON 0 1, OFF ON 0 1	517
[[:SENSe]:ACPower:OFFSet[1] 2:LIST:BANDwidth:VIDeo:AUTO?	517
[[:SENSe]:ACPower:OFFSet[1] 2:LIST:FILTer:ALPHa <real>, <real>, <real>, <real>, <real>, <real>	530
[[:SENSe]:ACPower:OFFSet[1] 2:LIST:FILTer:ALPHa?	530
[[:SENSe]:ACPower:OFFSet[1] 2:LIST:FILTer[:RRC][:STATe] ON OFF 1 0, ON OFF 1 0, ON OFF 1 0, ON OFF 1 0, ON OFF 1 0, ON OFF 1 0	529
[[:SENSe]:ACPower:OFFSet[1] 2:LIST:FILTer[:RRC][:STATe]?	529
[[:SENSe]:ACPower:OFFSet[1] 2:LIST[:FREQuency] <freq>, <freq>, <freq>, <freq>, <freq>, <freq>	511
[[:SENSe]:ACPower:OFFSet[1] 2:LIST[:FREQuency]?	511
[[:SENSe]:ACPower:OFFSet[1] 2:LIST:RCARrier <real>, <real>, <real>, <real>, <real>, <real>	522
[[:SENSe]:ACPower:OFFSet[1] 2:LIST:RCARrier?	522
[[:SENSe]:ACPower:OFFSet[1] 2:LIST:RPSDensity <rel_ampl>, <rel_ampl>, <rel_ampl>, <rel_ampl>, <rel_ampl>, <rel_ampl>	525
[[:SENSe]:ACPower:OFFSet[1] 2:LIST:RPSDensity?	525
[[:SENSe]:ACPower:OFFSet[1] 2:LIST:SIDE NEGative BOTH POSitive,NEGative BOTH POSitive,NEGative BOTH POSitive,NEGative BOTH POSitive,NE Gative BOTH POSitive,NEGative BOTH POSitive.	528
[[:SENSe]:ACPower:OFFSet[1] 2:LIST:SIDE?	528
[[:SENSe]:ACPower:OFFSet[1] 2:LIST:STATe OFF ON 0 1, OFF ON 0 1, OFF ON 0 1, OFF ON 0 1, OFF ON 0 1, OFF ON 0 1.	511
[[:SENSe]:ACPower:OFFSet[1] 2:LIST:STATe?	511
[[:SENSe]:ACPower:OFFSet[1] 2:LIST:TEST ABSolute AND OR RELative, ABSolute AND OR RELative, AB- Solute AND OR RELative, ABSolute AND OR RELative, ABSolute AND OR RELative, ABSo- lute AND OR RELative	527
[[:SENSe]:ACPower:OFFSet[1] 2:LIST:TEST?	527
[[:SENSe]:ACPower:OFFSet[1] 2:TYPE CTOCenter CTOEdge ETOCenter ETOEEdge	532
[[:SENSe]:ACPower:OFFSet[1] 2:TYPE?	532
[[:SENSe]:ACPower:SWEep:POINts <integer>	559
[[:SENSe]:ACPower:SWEep:POINts?	559
[[:SENSe]:ACPower:SWEep:TIME <time>	556

List of Commands

[:SENSe]:ACPower:SWEEP:TIME?	556
[:SENSe]:ACPower:SWEEP:TIME:AUTO OFF ON 0 1	556
[:SENSe]:ACPower:SWEEP:TIME:AUTO?	556
[:SENSe]:ACPower:SWEEP:TIME:AUTO:RULES NORMAl ACCuracy	558
[:SENSe]:ACPower:SWEEP:TIME:AUTO:RULES?	558
[:SENSe]:ACPower:TYPE TPRef PSDRef	536
[:SENSe]:ACPower:TYPE?	536
[:SENSe]:CEVM:DLINK:RESult ON OFF 0 1	1357
[:SENSe]:CEVM:DLINK:RESult?	1357
[:SENSe]:CEVM:EQualizer:TRaining	1355
[:SENSe]:CEVM:EVM:COPIY[:IMMediate]	1355
[:SENSe]:CEVM:IFBW <freq>	1345
[:SENSe]:CEVM:IFBW?	1345
[:SENSe]:CEVM:METHod NORMAl FAST	1353
[:SENSe]:CEVM:METHod?	1353
[:SENSe]:CEVM:ULINK:PROFile:USER1 50:HOPPing:SEQuence	1355
[:SENSe]:CEVM:ULINK:PROFile:USER1 50:PUSCh:MODulation:TYPE	1355
[:SENSe]:CEVM:ULINK:PROFile:USER:HOPPing:GROup	1355
[:SENSe]:CEVM:ULINK:PROFile:USER:PUSCh	1354
[:SENSe]:CEVM:ULINK:PROFile:USER:PUSCh:ACTive	1354
[:SENSe]:CEVM:ULINK:PROFile:USER:PUSCh:ADD:SLOT	1354
[:SENSe]:CEVM:ULINK:PROFile:USER:PUSCh:DMRS	1354
[:SENSe]:CEVM:ULINK:PROFile:USER:PUSCh:DMRS:ONE	1354
[:SENSe]:CEVM:ULINK:PROFile:USER:PUSCh:DMRS:PARams	1354
[:SENSe]:CEVM:ULINK:PROFile:USER:PUSCh:DMRS:TWO	1354
[:SENSe]:CEVM:ULINK:PROFile:USER:PUSCh:DSS	1354
[:SENSe]:CEVM:ULINK:PROFile:USER:PUSCh:FHOPPing	1355
[:SENSe]:CEVM:ULINK:PROFile:USER:PUSCh:RB:END	1354
[:SENSe]:CEVM:ULINK:PROFile:USER:PUSCh:RB:END:COUPle	1354
[:SENSe]:CEVM:ULINK:PROFile:USER:PUSCh:RB:STARt	1354
[:SENSe]:CEVM:ULINK:PROFile:USER:PUSCh:RB:STARt:COUPle	1354

List of Commands

[[:SENSe]:CEVM:ULINK:PROFile:USER:PUSCh:SSLot.	1355
[[:SENSe]:CEVM:ULINK:PROFile:USER:PUSCh:SSLot:AUTO.	1355
[[:SENSe]:CEVM:ULINK:RESult ON OFF 0 1,....	1358
[[:SENSe]:CEVM:ULINK:RESult?.	1358
[[:SENSe]:CHPower:AVERAge:COUNT <integer>.	345
[[:SENSe]:CHPower:AVERAge:COUNT?.	345
[[:SENSe]:CHPower:AVERAge[:STATe] ON OFF 1 0.	345
[[:SENSe]:CHPower:AVERAge[:STATe]?.	345
[[:SENSe]:CHPower:AVERAge:TCONtrol EXPonential REPeat.	346
[[:SENSe]:CHPower:AVERAge:TCONtrol?.	346
[[:SENSe]:CHPower:BANDwidth:INTegration <bandwidth>.	347
[[:SENSe]:CHPower:BANDwidth:INTegration?.	347
[[:SENSe]:CHPower:BANDwidth[:RESolution] <bandwidth>.	327
[[:SENSe]:CHPower:BANDwidth[:RESolution]?.	327
[[:SENSe]:CHPower:BANDwidth[:RESolution]:AUTO ON OFF 1 0.	327
[[:SENSe]:CHPower:BANDwidth[:RESolution]:AUTO?.	327
[[:SENSe]:CHPower:BANDwidth:SHAPe GAUSSian FLATtop.	330
[[:SENSe]:CHPower:BANDwidth:SHAPe?.	330
[[:SENSe]:CHPower:BANDwidth:VIDeo <bandwidth>.	328
[[:SENSe]:CHPower:BANDwidth:VIDeo?.	328
[[:SENSe]:CHPower:BANDwidth:VIDeo:AUTO ON OFF 1 0.	328
[[:SENSe]:CHPower:BANDwidth:VIDeo:AUTO?.	328
[[:SENSe]:CHPower:DETEctor:AUTO ON OFF 1 0.	378
[[:SENSe]:CHPower:DETEctor:AUTO?.	378
[[:SENSe]:CHPower:DETEctor[:FUNCTion] NORMal AVERAge POSitive SAMPlE NEGative.	377
[[:SENSe]:CHPower:DETEctor[:FUNCTion]?.	377
[[:SENSe]:CHPower:FILTer[:RRC]:ALPHa <real>.	352
[[:SENSe]:CHPower:FILTer[:RRC]:ALPHa?.	352
[[:SENSe]:CHPower:FILTer[:RRC]:BANDwidth <real>.	353
[[:SENSe]:CHPower:FILTer[:RRC]:BANDwidth?.	353
[[:SENSe]:CHPower:FILTer[:RRC][:STATe] OFF ON 0 1.	352

List of Commands

[[:SENSe]:CHPower:FILTer[:RRC][:STATe]?	352
[[:SENSe]:CHPower:FREQuency:SPAN <freq>	369
[[:SENSe]:CHPower:FREQuency:SPAN?	369
[[:SENSe]:CHPower:FREQuency:SPAN:FULL	370
[[:SENSe]:CHPower:FREQuency:SPAN:PREVious	371
[[:SENSe]:CHPower:FREQuency:SYNThesis:AUTO[:STATe] OFF ON 0 1	349
[[:SENSe]:CHPower:FREQuency:SYNThesis:AUTO[:STATe]?	349
[[:SENSe]:CHPower:FREQuency:SYNThesis[:STATe] 1 2 3	350
[[:SENSe]:CHPower:FREQuency:SYNThesis[:STATe]?	350
[[:SENSe]:CHPower:IF:GAIN:AUTO[:STATe] ON OFF 1 0	351
[[:SENSe]:CHPower:IF:GAIN:AUTO[:STATe]?	351
[[:SENSe]:CHPower:IF:GAIN[:STATe] ON OFF 1 0	351
[[:SENSe]:CHPower:IF:GAIN[:STATe]?	351
[[:SENSe]:CHPower:SHOUlder:OFFSet:FREQuency <freq>	360
[[:SENSe]:CHPower:SHOUlder:OFFSet:FREQuency?	360
[[:SENSe]:CHPower:SHOUlder:OFFSet:FREQuency:STARt <freq>	359
[[:SENSe]:CHPower:SHOUlder:OFFSet:FREQuency:STARt?	359
[[:SENSe]:CHPower:SHOUlder:OFFSet:FREQuency:STOP <freq>	359
[[:SENSe]:CHPower:SHOUlder:OFFSet:FREQuency:STOP?	359
[[:SENSe]:CHPower:SWEep:POINts <integer>	375
[[:SENSe]:CHPower:SWEep:POINts?	375
[[:SENSe]:CHPower:SWEep:TIME <time>	372
[[:SENSe]:CHPower:SWEep:TIME?	372
[[:SENSe]:CHPower:SWEep:TIME:AUTO OFF ON 0 1	372
[[:SENSe]:CHPower:SWEep:TIME:AUTO?	372
[[:SENSe]:CHPower:SWEep:TIME:AUTO:RULEs NORMAl ACCuracy	374
[[:SENSe]:CHPower:SWEep:TIME:AUTO:RULEs?	374
[[:SENSe]:CORRection:BTS[:RF]:GAIN <rel_ampl>	1471
[[:SENSe]:CORRection:BTS[:RF]:GAIN?	1471
[[:SENSe]:CORRection:BTS[:RF]:LOSS <rel_ampl>	1472
[[:SENSe]:CORRection:BTS[:RF]:LOSS?	1472

List of Commands

[[:SENSe]:CORRection:CSET[1] 2 3 4 5 6:COMMeNt "text"	1485
[[:SENSe]:CORRection:CSET[1] 2 3 4 5 6:COMMeNt?	1485
[[:SENSe]:CORRection:CSET[1] 2 3 4 5 6:DATA <freq>, <ampl>,	1489
[[:SENSe]:CORRection:CSET[1] 2 3 4 5 6:DATA?	1489
[[:SENSe]:CORRection:CSET[1] 2 3 4 5 6:DATA:MERGe <freq>, <ampl>,	1490
[[:SENSe]:CORRection:CSET[1] 2 3 4 5 6:DELeTe	1488
[[:SENSe]:CORRection:CSET[1] 2 3 4 5 6:DESCRiption "text"	1485
[[:SENSe]:CORRection:CSET[1] 2 3 4 5 6:DESCRiption?	1485
[[:SENSe]:CORRection:CSET[1] 2 3 4 5 6[:STATe] ON OFF 1 0	1480
[[:SENSe]:CORRection:CSET[1] 2 3 4 5 6[:STATe]?	1480
[[:SENSe]:CORRection:CSET[1] 2 3 4 5 6:X:SPACing LINear LOGarithmic.	1483
[[:SENSe]:CORRection:CSET[1] 2 3 4 5 6:X:SPACing?	1483
[[:SENSe]:CORRection:CSET[1] 2 3 4:ANTenna[:UNIT] GAUSs PTESla UVM UAM NOConversion	1481
[[:SENSe]:CORRection:CSET[1] 2 3 4:ANTenna[:UNIT]?	1481
[[:SENSe]:CORRection:CSET:ALL:DELeTe	1489
[[:SENSe]:CORRection:CSET:ALL[:STATe] ON OFF 1 0	1488
[[:SENSe]:CORRection:CSET:ALL[:STATe]?	1488
[[:SENSe]:CORRection:FEQualizer OFF NORMal INVert	1555
[[:SENSe]:CORRection:FEQualizer OFF NORMal INVert	1704
[[:SENSe]:CORRection:FEQualizer?	1555
[[:SENSe]:CORRection:FEQualizer?	1704
[[:SENSe]:CORRection:FEQualizer:REGiSter D1 D2 D3 D4 D5 D6.	1555
[[:SENSe]:CORRection:FEQualizer:REGiSter D1 D2 D3 D4 D5 D6.	1704
[[:SENSe]:CORRection:FEQualizer:REGiSter?	1555
[[:SENSe]:CORRection:FEQualizer:REGiSter?	1704
[[:SENSe]:CORRection:FEQualizer:RELative?	1705
[[:SENSe]:CORRection:IMPedance[:INPut][:MAGNitude] 50 75.	1425
[[:SENSe]:CORRection:IMPedance[:INPut][:MAGNitude]?	1425
[[:SENSe]:CORRection:IQ:I Q:ATTenuation <rel_ampl>	1463
[[:SENSe]:CORRection:IQ:I Q:ATTenuation?	1463
[[:SENSe]:CORRection:IQ:I Q:ATTenuation:RATio <real>	1463

List of Commands

[:SENSe]:CORRection:IQ:I:Q:ATTenuation:RATio?	1463
[:SENSe]:CORRection:IQ:I:GAIN <rel_ampl>	1473
[:SENSe]:CORRection:IQ:I:GAIN?	1473
[:SENSe]:CORRection:IQ[I]:SKEW <seconds>	1458
[:SENSe]:CORRection:IQ[I]:SKEW?	1458
[:SENSe]:CORRection:IQ:Q:GAIN <rel_ampl>	1473
[:SENSe]:CORRection:IQ:Q:GAIN?	1473
[:SENSe]:CORRection:IQ:Q:SKEW <seconds>	1462
[:SENSe]:CORRection:IQ:Q:SKEW?	1462
[:SENSe]:CORRection:MS[:RF]:GAIN <rel_ampl>	1470
[:SENSe]:CORRection:MS[:RF]:GAIN?	1470
[:SENSe]:CORRection:MS[:RF]:LOSS <rel_ampl>	1471
[:SENSe]:CORRection:MS[:RF]:LOSS?	1471
[:SENSe]:CORRection:NOISe:FLOor ON OFF 1 0	1557
[:SENSe]:CORRection:NOISe:FLOor?	1557
[:SENSe]:CORRection:SA[:RF]:GAIN <rel_ampl>	1470
[:SENSe]:CORRection:SA[:RF]:GAIN?	1470
[:SENSe]:EVM:AESpacing <double>	1170
[:SENSe]:EVM:AESpacing?	1170
[:SENSe]:EVM:DLINK:DECode:DFINclude F1F1B F1F1D F1 F1B F1D	
[:SENSe]:EVM:DLINK:DECode:DFINclude?	1132
[:SENSe]:EVM:DLINK:DECode:DFTWo:PRFour <integer>	1138
[:SENSe]:EVM:DLINK:DECode:DFTWo:PRFour?	1138
[:SENSe]:EVM:DLINK:DECode:DFTWo:PRONe <integer>	1136
[:SENSe]:EVM:DLINK:DECode:DFTWo:PRONe?	1136
[:SENSe]:EVM:DLINK:DECode:DFTWo:PRTHree <integer>	1138
[:SENSe]:EVM:DLINK:DECode:DFTWo:PRTHree?	1138
[:SENSe]:EVM:DLINK:DECode:DFTWo:PRTWo <integer>	1137
[:SENSe]:EVM:DLINK:DECode:DFTWo:PRTWo?	1137
[:SENSe]:EVM:DLINK:DECode:PBCH NONE DESCrambled DRMatched DECODEd	1126
[:SENSe]:EVM:DLINK:DECode:PBCH?	1126

List of Commands

[[:SENSe]:EVM:DLINK:DECode:PCFich NONE DESCrambled DECoded	1127
[[:SENSe]:EVM:DLINK:DECode:PCFich?	1127
[[:SENSe]:EVM:DLINK:DECode:PDCCh NONE DEMapped DINTerleaved DESCrambled DRMatched DECoded 1128	
[[:SENSe]:EVM:DLINK:DECode:PDCCh?	1128
[[:SENSe]:EVM:DLINK:DECode:PDSCh NONE DESCrambled DRMatched DCBLock DTBLock	1129
[[:SENSe]:EVM:DLINK:DECode:PDSCh?	1129
[[:SENSe]:EVM:DLINK:DECode:RNTI:MAXimum:RA <integer>	1134
[[:SENSe]:EVM:DLINK:DECode:RNTI:MAXimum:RA?.	1134
[[:SENSe]:EVM:DLINK:DECode:RNTI:MAXimum:TPC <integer>	1135
[[:SENSe]:EVM:DLINK:DECode:RNTI:MAXimum:TPC?.	1135
[[:SENSe]:EVM:DLINK:DECode:RNTI:MINimum:RA <integer>	1133
[[:SENSe]:EVM:DLINK:DECode:RNTI:MINimum:RA?	1133
[[:SENSe]:EVM:DLINK:DECode:RNTI:MINimum:TPC <integer>	1134
[[:SENSe]:EVM:DLINK:DECode:RNTI:MINimum:TPC?	1134
[[:SENSe]:EVM:DLINK:PDSCh:CSRatio R1 PB0 PB1 PB2 PB3	875
[[:SENSe]:EVM:DLINK:PDSCh:CSRatio?.	875
[[:SENSe]:EVM:DLINK:PROFile:ADD:USER	962
[[:SENSe]:EVM:DLINK:PROFile:AUTO[:DETect]:MODE POWer DECoded.	886
[[:SENSe]:EVM:DLINK:PROFile:AUTO[:DETect]:MODE?	886
[[:SENSe]:EVM:DLINK:PROFile:AUTO[:DETect]:POWer OFF ON 0 1	886
[[:SENSe]:EVM:DLINK:PROFile:AUTO[:DETect]:POWer?	886
[[:SENSe]:EVM:DLINK:PROFile:AUTO[:DETect]:POWer:ROUND OFF ON 0 1	887
[[:SENSe]:EVM:DLINK:PROFile:AUTO[:DETect]:POWer:ROUND?	887
[[:SENSe]:EVM:DLINK:PROFile:AUTO:PDSCh:CBINdex <integer>	969
[[:SENSe]:EVM:DLINK:PROFile:AUTO:PDSCh:CBINdex?	969
[[:SENSe]:EVM:DLINK:PROFile:AUTO:PDSCh:CDD WOCDd LDCDd	968
[[:SENSe]:EVM:DLINK:PROFile:AUTO:PDSCh:CDD?	968
[[:SENSe]:EVM:DLINK:PROFile:AUTO:PDSCh:NCODewords <integer>	967
[[:SENSe]:EVM:DLINK:PROFile:AUTO:PDSCh:NCODewords?	967
[[:SENSe]:EVM:DLINK:PROFile:AUTO:PDSCh:NLAYers <integer>	965

List of Commands

[:SENSe]:EVM:DLINK:PROFile:AUTO:PDSCh:NLAYers?	965
[:SENSe]:EVM:DLINK:PROFile:AUTO:PDSCh:PRECoding OFF TXDiversity SMULtiplex	964
[:SENSe]:EVM:DLINK:PROFile:AUTO:PDSCh:PRECoding?	964
[:SENSe]:EVM:DLINK:PROFile:AUTO:PDSCh:QAM16:CWONe:ENABle ON OFF 0 1	958
[:SENSe]:EVM:DLINK:PROFile:AUTO:PDSCh:QAM16:CWONe:ENABle?	958
[:SENSe]:EVM:DLINK:PROFile:AUTO:PDSCh:QAM16:CWONe:PWRBoost <rel_ampl>	951
[:SENSe]:EVM:DLINK:PROFile:AUTO:PDSCh:QAM16:CWONe:PWRBoost?	951
[:SENSe]:EVM:DLINK:PROFile:AUTO:PDSCh:QAM16:CWZero:ENABle ON OFF 0 1	956
[:SENSe]:EVM:DLINK:PROFile:AUTO:PDSCh:QAM16:CWZero:ENABle?	956
[:SENSe]:EVM:DLINK:PROFile:AUTO:PDSCh:QAM16:PWRBoost <rel_ampl>	949
[:SENSe]:EVM:DLINK:PROFile:AUTO:PDSCh:QAM16:PWRBoost?	949
[:SENSe]:EVM:DLINK:PROFile:AUTO:PDSCh:QAM64:CWONe:ENABle ON OFF 0 1	959
[:SENSe]:EVM:DLINK:PROFile:AUTO:PDSCh:QAM64:CWONe:ENABle?	959
[:SENSe]:EVM:DLINK:PROFile:AUTO:PDSCh:QAM64:CWONe:PWRBoost <rel_ampl>	952
[:SENSe]:EVM:DLINK:PROFile:AUTO:PDSCh:QAM64:CWONe:PWRBoost?	952
[:SENSe]:EVM:DLINK:PROFile:AUTO:PDSCh:QAM64:CWZero:ENABle ON OFF 0 1	957
[:SENSe]:EVM:DLINK:PROFile:AUTO:PDSCh:QAM64:CWZero:ENABle?	957
[:SENSe]:EVM:DLINK:PROFile:AUTO:PDSCh:QAM64:PWRBoost <rel_ampl>	950
[:SENSe]:EVM:DLINK:PROFile:AUTO:PDSCh:QAM64:PWRBoost?	950
[:SENSe]:EVM:DLINK:PROFile:AUTO:PDSCh:QPSK:CWONe:ENABle ON OFF 0 1	958
[:SENSe]:EVM:DLINK:PROFile:AUTO:PDSCh:QPSK:CWONe:ENABle?	958
[:SENSe]:EVM:DLINK:PROFile:AUTO:PDSCh:QPSK:CWONe:PWRBoost <rel_ampl>	951
[:SENSe]:EVM:DLINK:PROFile:AUTO:PDSCh:QPSK:CWONe:PWRBoost?	951
[:SENSe]:EVM:DLINK:PROFile:AUTO:PDSCh:QPSK:CWZero:ENABle ON OFF 0 1	956
[:SENSe]:EVM:DLINK:PROFile:AUTO:PDSCh:QPSK:CWZero:ENABle?	956
[:SENSe]:EVM:DLINK:PROFile:AUTO:PDSCh:QPSK:PWRBoost <rel_ampl>	949
[:SENSe]:EVM:DLINK:PROFile:AUTO:PDSCh:QPSK:PWRBoost?	949
[:SENSe]:EVM:DLINK:PROFile:CLEar	973
[:SENSe]:EVM:DLINK:PROFile:COUNT?	974
[:SENSe]:EVM:DLINK:PROFile:EUSers:COUNT <integer>	888
[:SENSe]:EVM:DLINK:PROFile:EUSers:COUNT?	888

List of Commands

[:SENSe]:EVM:DLINK:PROFile:EXCLude:ALL	889
[:SENSe]:EVM:DLINK:PROFile:IGNore	973
[:SENSe]:EVM:DLINK:PROFile:INCLude:ALL	888
[:SENSe]:EVM:DLINK:PROFile:PBCH INCLude EXCLude	891
[:SENSe]:EVM:DLINK:PROFile:PBCH?	891
[:SENSe]:EVM:DLINK:PROFile:PBCH:PWRBoost <rel_ampl>	899
[:SENSe]:EVM:DLINK:PROFile:PBCH:PWRBoost?	899
[:SENSe]:EVM:DLINK:PROFile:PCFich INCLude EXCLude	891
[:SENSe]:EVM:DLINK:PROFile:PCFich?	891
[:SENSe]:EVM:DLINK:PROFile:PCFich:PWRBoost <rel_ampl>	900
[:SENSe]:EVM:DLINK:PROFile:PCFich:PWRBoost?	900
[:SENSe]:EVM:DLINK:PROFile:PDCCh INCLude EXCLude	893
[:SENSe]:EVM:DLINK:PROFile:PDCCh?	893
[:SENSe]:EVM:DLINK:PROFile:PDCCh:ALLocation:AUTO[:DETECT] OFF ON 0 1	903
[:SENSe]:EVM:DLINK:PROFile:PDCCh:ALLocation:AUTO[:DETECT]?	903
[:SENSe]:EVM:DLINK:PROFile:PDCCh:ALLocation:CONStant OFF ON 0 1	903
[:SENSe]:EVM:DLINK:PROFile:PDCCh:ALLocation:CONStant?	903
[:SENSe]:EVM:DLINK:PROFile:PDCCh:ALLocation:SUBFrame0:SYMBOLS <integer>	904
[:SENSe]:EVM:DLINK:PROFile:PDCCh:ALLocation:SUBFrame0:SYMBOLS?	904
[:SENSe]:EVM:DLINK:PROFile:PDCCh:ALLocation:SUBFrame1:SYMBOLS <integer>	904
[:SENSe]:EVM:DLINK:PROFile:PDCCh:ALLocation:SUBFrame1:SYMBOLS?	904
[:SENSe]:EVM:DLINK:PROFile:PDCCh:ALLocation:SUBFrame2:SYMBOLS <integer>	905
[:SENSe]:EVM:DLINK:PROFile:PDCCh:ALLocation:SUBFrame2:SYMBOLS?	905
[:SENSe]:EVM:DLINK:PROFile:PDCCh:ALLocation:SUBFrame3:SYMBOLS <integer>	906
[:SENSe]:EVM:DLINK:PROFile:PDCCh:ALLocation:SUBFrame3:SYMBOLS?	906
[:SENSe]:EVM:DLINK:PROFile:PDCCh:ALLocation:SUBFrame4:SYMBOLS <integer>	906
[:SENSe]:EVM:DLINK:PROFile:PDCCh:ALLocation:SUBFrame4:SYMBOLS?	906
[:SENSe]:EVM:DLINK:PROFile:PDCCh:ALLocation:SUBFrame5:SYMBOLS <integer>	907
[:SENSe]:EVM:DLINK:PROFile:PDCCh:ALLocation:SUBFrame5:SYMBOLS?	907
[:SENSe]:EVM:DLINK:PROFile:PDCCh:ALLocation:SUBFrame6:SYMBOLS <integer>	908
[:SENSe]:EVM:DLINK:PROFile:PDCCh:ALLocation:SUBFrame6:SYMBOLS?	908

List of Commands

[:SENSe]:EVM:DLINK:PROFile:PDCCh:ALLocation:SUBFrame7:SYMBOLs <integer>	908
[:SENSe]:EVM:DLINK:PROFile:PDCCh:ALLocation:SUBFrame7:SYMBOLs?	908
[:SENSe]:EVM:DLINK:PROFile:PDCCh:ALLocation:SUBFrame8:SYMBOLs <integer>	909
[:SENSe]:EVM:DLINK:PROFile:PDCCh:ALLocation:SUBFrame8:SYMBOLs?	909
[:SENSe]:EVM:DLINK:PROFile:PDCCh:ALLocation:SUBFrame9:SYMBOLs <integer>	910
[:SENSe]:EVM:DLINK:PROFile:PDCCh:ALLocation:SUBFrame9:SYMBOLs?	910
[:SENSe]:EVM:DLINK:PROFile:PDCCh:PWRBoost <rel_ampl>	901
[:SENSe]:EVM:DLINK:PROFile:PDCCh:PWRBoost?	901
[:SENSe]:EVM:DLINK:PROFile:PDCCh:PWRBoost:STEP <rel_ampl>	902
[:SENSe]:EVM:DLINK:PROFile:PDCCh:PWRBoost:STEP?	902
[:SENSe]:EVM:DLINK:PROFile:PHICH INCLude EXCLude	892
[:SENSe]:EVM:DLINK:PROFile:PHICH?.	892
[:SENSe]:EVM:DLINK:PROFile:PHICH:ALLocation:RATio ADETECT R1BY6 R1BY2 R1 R2	913
[:SENSe]:EVM:DLINK:PROFile:PHICH:ALLocation:RATio?	913
[:SENSe]:EVM:DLINK:PROFile:PHICH:DESPread OFF ON 0 1	912
[:SENSe]:EVM:DLINK:PROFile:PHICH:DESPread?	912
[:SENSe]:EVM:DLINK:PROFile:PHICH:DURation ADETECT NORMAl EXTended	915
[:SENSe]:EVM:DLINK:PROFile:PHICH:DURation?	915
[:SENSe]:EVM:DLINK:PROFile:PHICH:MIDefinition STD ETM	916
[:SENSe]:EVM:DLINK:PROFile:PHICH:MIDefinition?	916
[:SENSe]:EVM:DLINK:PROFile:PHICH:PWRBoost <rel_ampl>	911
[:SENSe]:EVM:DLINK:PROFile:PHICH:PWRBoost?	911
[:SENSe]:EVM:DLINK:PROFile:PHICH:PWRBoost:STEP <rel_ampl>+	911
[:SENSe]:EVM:DLINK:PROFile:PHICH:PWRBoost:STEP?	911
[:SENSe]:EVM:DLINK:PROFile:PSS INCLude EXCLude	890
[:SENSe]:EVM:DLINK:PROFile:PSS?	890
[:SENSe]:EVM:DLINK:PROFile:PSS:PWRBoost <rel_ampl>	898
[:SENSe]:EVM:DLINK:PROFile:PSS:PWRBoost?	898
[:SENSe]:EVM:DLINK:PROFile:QAM16 INCLude EXCLude	896
[:SENSe]:EVM:DLINK:PROFile:QAM16?	896
[:SENSe]:EVM:DLINK:PROFile:QAM16:RNTI <integer>	924

List of Commands

[[:SENSe]:EVM:DLINK:PROFile:QAM16:RNTI?	924
[[:SENSe]:EVM:DLINK:PROFile:QAM16:UERS INCLude EXCLude	928
[[:SENSe]:EVM:DLINK:PROFile:QAM16:UERS?	928
[[:SENSe]:EVM:DLINK:PROFile:QAM16:UERS:ACTive OFF ON 0 1	926
[[:SENSe]:EVM:DLINK:PROFile:QAM16:UERS:ACTive?	926
[[:SENSe]:EVM:DLINK:PROFile:QAM16:UERS:PORT P5 P7 P8	933
[[:SENSe]:EVM:DLINK:PROFile:QAM16:UERS:PORT?	933
[[:SENSe]:EVM:DLINK:PROFile:QAM16:UERS:PWRBoost <rel_amp >	931
[[:SENSe]:EVM:DLINK:PROFile:QAM16:UERS:PWRBoost?	931
[[:SENSe]:EVM:DLINK:PROFile:QAM16:UERS:SCID <integer>	935
[[:SENSe]:EVM:DLINK:PROFile:QAM16:UERS:SCID?	935
[[:SENSe]:EVM:DLINK:PROFile:QAM64 INCLude EXCLude	896
[[:SENSe]:EVM:DLINK:PROFile:QAM64?	896
[[:SENSe]:EVM:DLINK:PROFile:QAM64:RNTI <integer>	924
[[:SENSe]:EVM:DLINK:PROFile:QAM64:RNTI?	924
[[:SENSe]:EVM:DLINK:PROFile:QAM64:UERS INCLude EXCLude	929
[[:SENSe]:EVM:DLINK:PROFile:QAM64:UERS?	929
[[:SENSe]:EVM:DLINK:PROFile:QAM64:UERS:ACTive OFF ON 0 1	927
[[:SENSe]:EVM:DLINK:PROFile:QAM64:UERS:ACTive?	927
[[:SENSe]:EVM:DLINK:PROFile:QAM64:UERS:PORT P5 P7 P8	934
[[:SENSe]:EVM:DLINK:PROFile:QAM64:UERS:PORT?	934
[[:SENSe]:EVM:DLINK:PROFile:QAM64:UERS:PWRBoost <rel_amp >	931
[[:SENSe]:EVM:DLINK:PROFile:QAM64:UERS:PWRBoost?	931
[[:SENSe]:EVM:DLINK:PROFile:QAM64:UERS:SCID <integer>	936
[[:SENSe]:EVM:DLINK:PROFile:QAM64:UERS:SCID?	936
[[:SENSe]:EVM:DLINK:PROFile:QPSK INCLude EXCLude	895
[[:SENSe]:EVM:DLINK:PROFile:QPSK?	895
[[:SENSe]:EVM:DLINK:PROFile:QPSK:RNTI <integer>	923
[[:SENSe]:EVM:DLINK:PROFile:QPSK:RNTI?	923
[[:SENSe]:EVM:DLINK:PROFile:QPSK:UERS INCLude EXCLude	928
[[:SENSe]:EVM:DLINK:PROFile:QPSK:UERS?	928

List of Commands

[:SENSe]:EVM:DLINK:PROFile:QPSK:UERS:ACTive OFF ON 0 1	926
[:SENSe]:EVM:DLINK:PROFile:QPSK:UERS:ACTive?	926
[:SENSe]:EVM:DLINK:PROFile:QPSK:UERS:PORT P5 P7 P8	933
[:SENSe]:EVM:DLINK:PROFile:QPSK:UERS:PORT?	933
[:SENSe]:EVM:DLINK:PROFile:QPSK:UERS:PWRBoost <rel_ampl>	930
[:SENSe]:EVM:DLINK:PROFile:QPSK:UERS:PWRBoost?	930
[:SENSe]:EVM:DLINK:PROFile:QPSK:UERS:SCID <integer>	935
[:SENSe]:EVM:DLINK:PROFile:QPSK:UERS:SCID?	935
[:SENSe]:EVM:DLINK:PROFile:RS INCLude EXCLude	892
[:SENSe]:EVM:DLINK:PROFile:RS?	892
[:SENSe]:EVM:DLINK:PROFile:RS:PWRBoost <rel_ampl>	900
[:SENSe]:EVM:DLINK:PROFile:RS:PWRBoost?	900
[:SENSe]:EVM:DLINK:PROFile:SSS INCLude EXCLude	890
[:SENSe]:EVM:DLINK:PROFile:SSS?	890
[:SENSe]:EVM:DLINK:PROFile:SSS:PWRBoost <rel_ampl>	899
[:SENSe]:EVM:DLINK:PROFile:SSS:PWRBoost?	899
[:SENSe]:EVM:DLINK:PROFile:UPDate	973
[:SENSe]:EVM:DLINK:PROFile:USER<n>:DECoded:PDSCh INCLude EXCLude	895
[:SENSe]:EVM:DLINK:PROFile:USER<n>:DECoded:PDSCh?	895
[:SENSe]:EVM:DLINK:PROFile:USER<n>:DECoded:PDSCh:CWONe:ENABle ON OFF 0 1	960
[:SENSe]:EVM:DLINK:PROFile:USER<n>:DECoded:PDSCh:CWONe:ENABle?	960
[:SENSe]:EVM:DLINK:PROFile:USER<n>:DECoded:PDSCh:CWONe:PWRBoost <rel_ampl>	953
[:SENSe]:EVM:DLINK:PROFile:USER<n>:DECoded:PDSCh:CWONe:PWRBoost?	953
[:SENSe]:EVM:DLINK:PROFile:USER<n>:DECoded:PDSCh:CWZero:ENABle ON OFF 0 1	959
[:SENSe]:EVM:DLINK:PROFile:USER<n>:DECoded:PDSCh:CWZero:ENABle?	959
[:SENSe]:EVM:DLINK:PROFile:USER<n>:DECoded:PDSCh:CWZero:PWRBoost <rel_ampl>	953
[:SENSe]:EVM:DLINK:PROFile:USER<n>:DECoded:PDSCh:CWZero:PWRBoost?	953
[:SENSe]:EVM:DLINK:PROFile:USER<n>:DELete	963
[:SENSe]:EVM:DLINK:PROFile:USER<n>:PDSCh INCLude EXCLude	894
[:SENSe]:EVM:DLINK:PROFile:USER<n>:PDSCh?	894
[:SENSe]:EVM:DLINK:PROFile:USER<n>:PDSCh:ADD:ALLocation	921

List of Commands

[:SENSe]:EVM:DLINK:PROFile:USER<n>:PDSCh:COUNt?	974
[:SENSe]:EVM:DLINK:PROFile:USER<n>:PDSCh:CWONe:MODulation:TYPE QPSK QAM16 QAM64	945
[:SENSe]:EVM:DLINK:PROFile:USER<n>:PDSCh:CWONe:MODulation:TYPE?	945
[:SENSe]:EVM:DLINK:PROFile:USER<n>:PDSCh:CWONe:MODulation:TYPE:COUPle OFF ON 0 1	947
[:SENSe]:EVM:DLINK:PROFile:USER<n>:PDSCh:CWONe:MODulation:TYPE:COUPle?	947
[:SENSe]:EVM:DLINK:PROFile:USER<n>:PDSCh:CWONe:PWRBoost <rel_ampl>	950
[:SENSe]:EVM:DLINK:PROFile:USER<n>:PDSCh:CWONe:PWRBoost?	950
[:SENSe]:EVM:DLINK:PROFile:USER<n>:PDSCh:CWONe:PWRBoost:COUPle OFF ON 0 1	955
[:SENSe]:EVM:DLINK:PROFile:USER<n>:PDSCh:CWONe:PWRBoost:COUPle?	955
[:SENSe]:EVM:DLINK:PROFile:USER<n>:PDSCh:FINDeX F0 F1	960
[:SENSe]:EVM:DLINK:PROFile:USER<n>:PDSCh:FINDeX?	960
[:SENSe]:EVM:DLINK:PROFile:USER<n>:PDSCh:FINDeX:COUPle OFF ON 0 1	962
[:SENSe]:EVM:DLINK:PROFile:USER<n>:PDSCh:FINDeX:COUPle?	962
[:SENSe]:EVM:DLINK:PROFile:USER<n>:PDSCh:MODulation:TYPE QPSK QAM16 QAM64	945
[:SENSe]:EVM:DLINK:PROFile:USER<n>:PDSCh:MODulation:TYPE?	945
[:SENSe]:EVM:DLINK:PROFile:USER<n>:PDSCh:MODulation:TYPE:COUPle OFF ON 0 1	947
[:SENSe]:EVM:DLINK:PROFile:USER<n>:PDSCh:MODulation:TYPE:COUPle?	947
[:SENSe]:EVM:DLINK:PROFile:USER<n>:PDSCh:PWRBoost <rel_ampl>	948
[:SENSe]:EVM:DLINK:PROFile:USER<n>:PDSCh:PWRBoost?	948
[:SENSe]:EVM:DLINK:PROFile:USER<n>:PDSCh:PWRBoost:COUPle OFF ON 0 1	954
[:SENSe]:EVM:DLINK:PROFile:USER<n>:PDSCh:PWRBoost:COUPle?	954
[:SENSe]:EVM:DLINK:PROFile:USER<n>:PDSCh:RBALloc<m>:CWONe:MODulation:TYPE QPSK QAM16 QAM64	941
[:SENSe]:EVM:DLINK:PROFile:USER<n>:PDSCh:RBALloc<m>:CWONe:MODulation:TYPE?	941
[:SENSe]:EVM:DLINK:PROFile:USER<n>:PDSCh:RBALloc<m>:CWONe:PWRBoost <rel_ampl>	943
[:SENSe]:EVM:DLINK:PROFile:USER<n>:PDSCh:RBALloc<m>:CWONe:PWRBoost?	943
[:SENSe]:EVM:DLINK:PROFile:USER<n>:PDSCh:RBALloc<m>:DElete	922
[:SENSe]:EVM:DLINK:PROFile:USER<n>:PDSCh:RBALloc<m>:FINDeX F0 F1	944
[:SENSe]:EVM:DLINK:PROFile:USER<n>:PDSCh:RBALloc<m>:FINDeX?	944
[:SENSe]:EVM:DLINK:PROFile:USER<n>:PDSCh:RBALloc<m>:MODulation:TYPE QPSK QAM16 QAM64 . 940	
[:SENSe]:EVM:DLINK:PROFile:USER<n>:PDSCh:RBALloc<m>:MODulation:TYPE?	940

List of Commands

[::SENSe]:EVM:DLINK:PROFile:USER<n>:PDSCh:RBALloc<m>:PWRBoost <rel_amp>	942
[::SENSe]:EVM:DLINK:PROFile:USER<n>:PDSCh:RBALloc<m>:PWRBoost?	942
[::SENSe]:EVM:DLINK:PROFile:USER<n>:PDSCh:RBALloc<m>:RB:END <integer>	938
[::SENSe]:EVM:DLINK:PROFile:USER<n>:PDSCh:RBALloc<m>:RB:END?	938
[::SENSe]:EVM:DLINK:PROFile:USER<n>:PDSCh:RBALloc<m>:RB:START <integer>	937
[::SENSe]:EVM:DLINK:PROFile:USER<n>:PDSCh:RBALloc<m>:RB:START?	937
[::SENSe]:EVM:DLINK:PROFile:USER<n>:PDSCh:RBALloc<m>:SLOT:END <integer>	940
[::SENSe]:EVM:DLINK:PROFile:USER<n>:PDSCh:RBALloc<m>:SLOT:END?	940
[::SENSe]:EVM:DLINK:PROFile:USER<n>:PDSCh:RBALloc<m>:SLOT:START <integer>	939
[::SENSe]:EVM:DLINK:PROFile:USER<n>:PDSCh:RBALloc<m>:SLOT:START?	939
[::SENSe]:EVM:DLINK:PROFile:USER<n>:RNTI <integer>	923
[::SENSe]:EVM:DLINK:PROFile:USER<n>:RNTI?	923
[::SENSe]:EVM:DLINK:PROFile:USER<n>:UERS INCLude EXCLude	927
[::SENSe]:EVM:DLINK:PROFile:USER<n>:UERS?	927
[::SENSe]:EVM:DLINK:PROFile:USER<n>:UERS:ACTive OFF ON 0 1	925
[::SENSe]:EVM:DLINK:PROFile:USER<n>:UERS:ACTive?	925
[::SENSe]:EVM:DLINK:PROFile:USER<n>:UERS:PORT P5 P7 P8	932
[::SENSe]:EVM:DLINK:PROFile:USER<n>:UERS:PORT?	932
[::SENSe]:EVM:DLINK:PROFile:USER<n>:UERS:PWRBoost <rel_amp>	930
[::SENSe]:EVM:DLINK:PROFile:USER<n>:UERS:PWRBoost?	930
[::SENSe]:EVM:DLINK:PROFile:USER<n>:UERS:SCID <integer>	934
[::SENSe]:EVM:DLINK:PROFile:USER<n>:UERS:SCID?	934
[::SENSe]:EVM:DLINK:PROFile:USER1 50:PDSCh:CBINdex <integer>	968
[::SENSe]:EVM:DLINK:PROFile:USER1 50:PDSCh:CBINdex?	968
[::SENSe]:EVM:DLINK:PROFile:USER1 50:PDSCh:CDD WOCDD LDCDD	967
[::SENSe]:EVM:DLINK:PROFile:USER1 50:PDSCh:CDD?	967
[::SENSe]:EVM:DLINK:PROFile:USER1 50:PDSCh:CWONe:ENABle ON OFF 0 1	957
[::SENSe]:EVM:DLINK:PROFile:USER1 50:PDSCh:CWONe:ENABle?	957
[::SENSe]:EVM:DLINK:PROFile:USER1 50:PDSCh:CWZero:ENABle ON OFF 0 1	955
[::SENSe]:EVM:DLINK:PROFile:USER1 50:PDSCh:CWZero:ENABle?	955
[::SENSe]:EVM:DLINK:PROFile:USER1 50:PDSCh:NCODewords <integer>	966

List of Commands

[[:SENSe]:EVM:DLINK:PROFile:USER1 50:PDsch:NCODewords?	966
[[:SENSe]:EVM:DLINK:PROFile:USER1 50:PDsch:NLAYers <integer>	965
[[:SENSe]:EVM:DLINK:PROFile:USER1 50:PDsch:NLAYers?	965
[[:SENSe]:EVM:DLINK:PROFile:USER1 50:PDsch:PRECoding OFF TXDiversity SMULTiplex	964
[[:SENSe]:EVM:DLINK:PROFile:USER1 50:PDsch:PRECoding?	964
[[:SENSe]:EVM:DLINK:SYNC:ANTenna:DETECT:THReshold <rel_amp!>.	870
[[:SENSe]:EVM:DLINK:SYNC:ANTenna:DETECT:THReshold?	870
[[:SENSe]:EVM:DLINK:SYNC:ANTenna:INACTIVE:PATHs INCLude EXCLude	872
[[:SENSe]:EVM:DLINK:SYNC:ANTenna:INACTIVE:PATHs?	872
[[:SENSe]:EVM:DLINK:SYNC:ANTenna:NUMBER ANT1 ANT2 ANT4	866
[[:SENSe]:EVM:DLINK:SYNC:ANTenna:NUMBER?	866
[[:SENSe]:EVM:DLINK:SYNC:ANTenna:PORT P0 P1 P2 P3	868
[[:SENSe]:EVM:DLINK:SYNC:ANTenna:PORT?	868
[[:SENSe]:EVM:DLINK:SYNC:ANTenna:PORT:AUTO OFF ON 0 1	868
[[:SENSe]:EVM:DLINK:SYNC:ANTenna:PORT:AUTO?	868
[[:SENSe]:EVM:DLINK:SYNC:CID <integer>	865
[[:SENSe]:EVM:DLINK:SYNC:CID?	865
[[:SENSe]:EVM:DLINK:SYNC:CID:AUTO OFF ON 0 1	865
[[:SENSe]:EVM:DLINK:SYNC:CID:AUTO?	865
[[:SENSe]:EVM:DLINK:SYNC:CPLength AUTO NORMal EXTended	1147
[[:SENSe]:EVM:DLINK:SYNC:CPLength?	1147
[[:SENSe]:EVM:DLINK:SYNC:CPLength:AUTO OFF ON 0 1	1147
[[:SENSe]:EVM:DLINK:SYNC:CPLength:AUTO?	1147
[[:SENSe]:EVM:DLINK:SYNC:MIMO:DECoding NONE GPPMimo	874
[[:SENSe]:EVM:DLINK:SYNC:MIMO:DECoding?	874
[[:SENSe]:EVM:DLINK:SYNC:RSPRs GPP CUSTom	864
[[:SENSe]:EVM:DLINK:SYNC:RSPRs?	864
[[:SENSe]:EVM:DLINK:SYNC:SS:ANTenna:PORT P0 P1 P2 P3 APORTs.	871
[[:SENSe]:EVM:DLINK:SYNC:SS:ANTenna:PORT?	871
[[:SENSe]:EVM:DLINK:SYNC:TYPE PSS RS	862
[[:SENSe]:EVM:DLINK:SYNC:TYPE?	862

List of Commands

[:SENSe]:EVM:DLINK:UERS:CFRCompen OFF ON 0 1	1162
[:SENSe]:EVM:DLINK:UERS:CFRCompen?	1162
[:SENSe]:EVM:DLINK:UERS:WEIGhts:DISPlay PSUBcarrier PRB PUSeR	1163
[:SENSe]:EVM:DLINK:UERS:WEIGhts:DISPlay?	1163
[:SENSe]:EVM:DLINK:UERS:WEIGhts:RIFormat OFF ON 0 1	1162
[:SENSe]:EVM:DLINK:UERS:WEIGhts:RIFormat?	1162
[:SENSe]:EVM:EETTime OFF ON 0 1	1169
[:SENSe]:EVM:EETTime?	1169
[:SENSe]:EVM:EQUalizer:TRaining OFF RS RSD	1152
[:SENSe]:EVM:EQUalizer:TRaining?	1152
[:SENSe]:EVM:EQUalizer:TRaining:MAFilter OFF ON 0 1	1153
[:SENSe]:EVM:EQUalizer:TRaining:MAFilter?	1153
[:SENSe]:EVM:EQUalizer:TRaining:MAFilter:LENGth <integer>	1153
[:SENSe]:EVM:EQUalizer:TRaining:MAFilter:LENGth?	1153
[:SENSe]:EVM:EQUalizer:TRaining:MCFNormalize OFF ON 0 1	1154
[:SENSe]:EVM:EQUalizer:TRaining:MCFNormalize?	1154
[:SENSe]:EVM:EQUalizer:TRaining:MODE ZFORcing LSQuares	1154
[:SENSe]:EVM:EQUalizer:TRaining:MODE?	1154
[:SENSe]:EVM:EVMMinimize OFF GPP TRACKing	1166
[:SENSe]:EVM:EVMMinimize?	1166
[:SENSe]:EVM:EVMMinimize:AMPLitude OFF ON 0 1	1168
[:SENSe]:EVM:EVMMinimize:AMPLitude?	1168
[:SENSe]:EVM:EVMMinimize:FREQuency OFF ON 0 1	1167
[:SENSe]:EVM:EVMMinimize:FREQuency?	1167
[:SENSe]:EVM:EVMMinimize:IQOFfset OFF ON 0 1	1168
[:SENSe]:EVM:EVMMinimize:IQOFfset?	1168
[:SENSe]:EVM:EVMMinimize:TIMing OFF ON 0 1	1167
[:SENSe]:EVM:EVMMinimize:TIMing?	1167
[:SENSe]:EVM:EXTended:FREQuency:LOCK:RANGe OFF ON 0 1	1150
[:SENSe]:EVM:EXTended:FREQuency:LOCK:RANGe?	1150
[:SENSe]:EVM:FREQuency:SYNThesis[:STATe] 1 2	1164

List of Commands

[[:SENSe]:EVM:FREQuency:SYNThesis[:STATe]?	1164
[[:SENSe]:EVM:MCFilter:STATe OFF ON 0 1	1164
[[:SENSe]:EVM:MCFilter:STATe?	1164
[[:SENSe]:EVM:ODActive OFF ON 0 1	1169
[[:SENSe]:EVM:ODActive?	1169
[[:SENSe]:EVM:POWer:BOOSt:NORMAlize OFF ON 0 1	1161
[[:SENSe]:EVM:POWer:BOOSt:NORMAlize?	1161
[[:SENSe]:EVM:PROFile:AUTO[:DETECT] OFF ON 0 1	885
[[:SENSe]:EVM:PROFile:AUTO[:DETECT]?	885
[[:SENSe]:EVM:PROFile:COpy[:IMMEdiate]	974
[[:SENSe]:EVM:PROFile:MFANAlysis OFF ON 0 1	920
[[:SENSe]:EVM:PROFile:MFANAlysis?	920
[[:SENSe]:EVM:PROFile:NALLocation INCLude EXCLude	893
[[:SENSe]:EVM:PROFile:NALLocation?	893
[[:SENSe]:EVM:PROFile:SMAPping[:SElect] F0 F1	920
[[:SENSe]:EVM:PROFile:SMAPping[:SElect]?	920
[[:SENSe]:EVM:REPort:DB OFF ON 0 1	1160
[[:SENSe]:EVM:REPort:DB?	1160
[[:SENSe]:EVM:REPort:POWer:RELAtive OFF ON 0 1	1161
[[:SENSe]:EVM:REPort:POWer:RELAtive?	1161
[[:SENSe]:EVM:SYMBol:TIMing:ADJust MAX MIN STARt END CENTer FFTSIZE	1155
[[:SENSe]:EVM:SYMBol:TIMing:ADJust?	1155
[[:SENSe]:EVM:SYMBol:TIMing:ADJust:USER <percent>	1157
[[:SENSe]:EVM:SYMBol:TIMing:ADJust:USER?	1157
[[:SENSe]:EVM:TIME:ASBoundary FRAME HALF SUB SLOT	883
[[:SENSe]:EVM:TIME:ASBoundary?	883
[[:SENSe]:EVM:TIME:INTerval:SLOT <integer>	881
[[:SENSe]:EVM:TIME:INTerval:SLOT?	881
[[:SENSe]:EVM:TIME:INTerval:SYMBol <integer>	882
[[:SENSe]:EVM:TIME:INTerval:SYMBol?	882
[[:SENSe]:EVM:TIME:OFFSet:SLOT <integer>	880

List of Commands

[:SENSe]:EVM:TIME:OFFSet:SLOT?	880
[:SENSe]:EVM:TIME:OFFSet:SYMBOL <integer>	880
[:SENSe]:EVM:TIME:OFFSet:SYMBOL?	880
[:SENSe]:EVM:TIME:RESult:LENGth <integer>	879
[:SENSe]:EVM:TIME:RESult:LENGth?	879
[:SENSe]:EVM:TIME:SCALe:FACTor <value>	1163
[:SENSe]:EVM:TIME:SCALe:FACTor?	1163
[:SENSe]:EVM:ULINK:DECode:ANFMode MULTiplexing BUNDling	1146
[:SENSe]:EVM:ULINK:DECode:ANFMode?	1146
[:SENSe]:EVM:ULINK:DECode:PUCCh NONE DESCrambled DECoded	1131
[:SENSe]:EVM:ULINK:DECode:PUCCh?	1131
[:SENSe]:EVM:ULINK:DECode:PUCCh:CQI:ISIZe <integer>	1145
[:SENSe]:EVM:ULINK:DECode:PUCCh:CQI:ISIZe?	1145
[:SENSe]:EVM:ULINK:DECode:PUCCh:CQI:ISIZe:AUTO OFF ON 0 1	1145
[:SENSe]:EVM:ULINK:DECode:PUCCh:CQI:ISIZe:AUTO?	1145
[:SENSe]:EVM:ULINK:DECode:PUCCh:HARQ:ISIZe <integer>	1144
[:SENSe]:EVM:ULINK:DECode:PUCCh:HARQ:ISIZe?	1144
[:SENSe]:EVM:ULINK:DECode:PUCCh:HARQ:ISIZe:AUTO OFF ON 0 1	1144
[:SENSe]:EVM:ULINK:DECode:PUCCh:HARQ:ISIZe:AUTO?	1144
[:SENSe]:EVM:ULINK:DECode:PUSCh NONE DESCrambled DRMAtched DCBLock DTBLock	1130
[:SENSe]:EVM:ULINK:DECode:PUSCh?	1130
[:SENSe]:EVM:ULINK:DECode:PUSCh:CQI:ISIZe <integer>	1142
[:SENSe]:EVM:ULINK:DECode:PUSCh:CQI:ISIZe?	1142
[:SENSe]:EVM:ULINK:DECode:PUSCh:CQI:ISIZe:AUTO OFF ON 0 1	1142
[:SENSe]:EVM:ULINK:DECode:PUSCh:CQI:ISIZe:AUTO?	1142
[:SENSe]:EVM:ULINK:DECode:PUSCh:CQI:OFFSet <integer>	1143
[:SENSe]:EVM:ULINK:DECode:PUSCh:CQI:OFFSet?	1143
[:SENSe]:EVM:ULINK:DECode:PUSCh:HARQ:ISIZe <integer>	1140
[:SENSe]:EVM:ULINK:DECode:PUSCh:HARQ:ISIZe?	1140
[:SENSe]:EVM:ULINK:DECode:PUSCh:HARQ:ISIZe:AUTO OFF ON 0 1	1140
[:SENSe]:EVM:ULINK:DECode:PUSCh:HARQ:ISIZe:AUTO?	1140

List of Commands

[[:SENSe]:EVM:ULINK:DECode:PUSCh:HARQ:OFFSet <integer>	1140
[[:SENSe]:EVM:ULINK:DECode:PUSCh:HARQ:OFFSet?	1140
[[:SENSe]:EVM:ULINK:DECode:PUSCh:RI:ISIZe <integer>	1141
[[:SENSe]:EVM:ULINK:DECode:PUSCh:RI:ISIZe?	1141
[[:SENSe]:EVM:ULINK:DECode:PUSCh:RI:ISIZe:AUTO OFF ON 0 1	1141
[[:SENSe]:EVM:ULINK:DECode:PUSCh:RI:ISIZe:AUTO?	1141
[[:SENSe]:EVM:ULINK:DECode:PUSCh:RI:OFFSet <integer>	1142
[[:SENSe]:EVM:ULINK:DECode:PUSCh:RI:OFFSet?	1142
[[:SENSe]:EVM:ULINK:PROFile:ADD:USER	990
[[:SENSe]:EVM:ULINK:PROFile:AUTO:CID <integer>	992
[[:SENSe]:EVM:ULINK:PROFile:AUTO:CID?	992
[[:SENSe]:EVM:ULINK:PROFile:AUTO[:DETect]:POWer OFF ON 0 1	975
[[:SENSe]:EVM:ULINK:PROFile:AUTO[:DETect]:POWer?	975
[[:SENSe]:EVM:ULINK:PROFile:AUTO:HOPPing:GROup OFF ON 0 1	995
[[:SENSe]:EVM:ULINK:PROFile:AUTO:HOPPing:GROup?	995
[[:SENSe]:EVM:ULINK:PROFile:AUTO:HOPPing:SEQuence OFF ON 0 1	997
[[:SENSe]:EVM:ULINK:PROFile:AUTO:HOPPing:SEQuence?	997
[[:SENSe]:EVM:ULINK:PROFile:AUTO:PRACH INCLude EXCLude	983
[[:SENSe]:EVM:ULINK:PROFile:AUTO:PRACH: PINDeX?	1096
[[:SENSe]:EVM:ULINK:PROFile:AUTO:PRACH?	983
[[:SENSe]:EVM:ULINK:PROFile:AUTO:PRACH:ACTive OFF ON 0 1	1088
[[:SENSe]:EVM:ULINK:PROFile:AUTO:PRACH:ACTive?	1088
[[:SENSe]:EVM:ULINK:PROFile:AUTO:PRACH:CINDeX <integer>	1091
[[:SENSe]:EVM:ULINK:PROFile:AUTO:PRACH:CINDeX?	1091
[[:SENSe]:EVM:ULINK:PROFile:AUTO:PRACH:CSSet UNReStRicted REStRicted	1094
[[:SENSe]:EVM:ULINK:PROFile:AUTO:PRACH:CSSet?	1094
[[:SENSe]:EVM:ULINK:PROFile:AUTO:PRACH:LRSindex <integer>	1093
[[:SENSe]:EVM:ULINK:PROFile:AUTO:PRACH:LRSindex?	1093
[[:SENSe]:EVM:ULINK:PROFile:AUTO:PRACH:NCSConfig <integer>	1095
[[:SENSe]:EVM:ULINK:PROFile:AUTO:PRACH:NCSConfig?	1095
[[:SENSe]:EVM:ULINK:PROFile:AUTO:PRACH:NRAPrb <integer>	1090

List of Commands

[:SENSe]:EVM:ULINK:PROFile:AUTO:PRACh:NRAPrb?	1090
[:SENSe]:EVM:ULINK:PROFile:AUTO:PRACh:PINdex <integer>	1096
[:SENSe]:EVM:ULINK:PROFile:AUTO:PRACh:PWRBoost <rel_ampI>	1097
[:SENSe]:EVM:ULINK:PROFile:AUTO:PRACh:PWRBoost?	1097
[:SENSe]:EVM:ULINK:PROFile:AUTO:PRACh:SRESource <integer>	1099
[:SENSe]:EVM:ULINK:PROFile:AUTO:PRACh:SRESource?	1099
[:SENSe]:EVM:ULINK:PROFile:AUTO:PUCCh INCLude EXCLude	981
[:SENSe]:EVM:ULINK:PROFile:AUTO:PUCCh?	981
[:SENSe]:EVM:ULINK:PROFile:AUTO:PUCCh:ACTive OFF ON 0 1	1045
[:SENSe]:EVM:ULINK:PROFile:AUTO:PUCCh:ACTive?	1045
[:SENSe]:EVM:ULINK:PROFile:AUTO:PUCCh:CSHift <integer>	1062
[:SENSe]:EVM:ULINK:PROFile:AUTO:PUCCh:CSHift?	1062
[:SENSe]:EVM:ULINK:PROFile:AUTO:PUCCh:DMRS INCLude EXCLude	982
[:SENSe]:EVM:ULINK:PROFile:AUTO:PUCCh:DMRS?	982
[:SENSe]:EVM:ULINK:PROFile:AUTO:PUCCh:DMRS:GROup <integer>	1069
[:SENSe]:EVM:ULINK:PROFile:AUTO:PUCCh:DMRS:GROup?	1069
[:SENSe]:EVM:ULINK:PROFile:AUTO:PUCCh:DMRS:PARams OFF ON 0 1	1046
[:SENSe]:EVM:ULINK:PROFile:AUTO:PUCCh:DMRS:PARams?	1046
[:SENSe]:EVM:ULINK:PROFile:AUTO:PUCCh:DMRS:PWRBoost <rel_ampI>	1072
[:SENSe]:EVM:ULINK:PROFile:AUTO:PUCCh:DMRS:PWRBoost?	1072
[:SENSe]:EVM:ULINK:PROFile:AUTO:PUCCh:FNPucch:AUTO OFF ON 0 1	1055
[:SENSe]:EVM:ULINK:PROFile:AUTO:PUCCh:FNPucch:AUTO?	1055
[:SENSe]:EVM:ULINK:PROFile:AUTO:PUCCh:FORMat T1 T1A T1B T2 T2A T2B T1S T1AS T1BS	1058
[:SENSe]:EVM:ULINK:PROFile:AUTO:PUCCh:FORMat?	1058
[:SENSe]:EVM:ULINK:PROFile:AUTO:PUCCh:NCS:ONE <integer>	1049
[:SENSe]:EVM:ULINK:PROFile:AUTO:PUCCh:NCS:ONE?	1049
[:SENSe]:EVM:ULINK:PROFile:AUTO:PUCCh:N:ONE <integer>	1074
[:SENSe]:EVM:ULINK:PROFile:AUTO:PUCCh:N:ONE?	1074
[:SENSe]:EVM:ULINK:PROFile:AUTO:PUCCh:NRB:TWO <integer>	1048
[:SENSe]:EVM:ULINK:PROFile:AUTO:PUCCh:NRB:TWO?	1048
[:SENSe]:EVM:ULINK:PROFile:AUTO:PUCCh:N:TWO <integer>	1050

List of Commands

[:SENSe]:EVM:ULINK:PROFile:AUTO:PUCCh:N:TWO?	1050
[:SENSe]:EVM:ULINK:PROFile:AUTO:PUCCh:OS INDeX0 INDeX1 INDeX2	1064
[:SENSe]:EVM:ULINK:PROFile:AUTO:PUCCh:OS?	1064
[:SENSe]:EVM:ULINK:PROFile:AUTO:PUCCh:PWRBoost <rel_amp>	1067
[:SENSe]:EVM:ULINK:PROFile:AUTO:PUCCh:PWRBoost?	1067
[:SENSe]:EVM:ULINK:PROFile:AUTO:PUCCh:RB <integer>	1056
[:SENSe]:EVM:ULINK:PROFile:AUTO:PUCCh:RB?	1056
[:SENSe]:EVM:ULINK:PROFile:AUTO:PUCCh:SHIFt <integer>	1052
[:SENSe]:EVM:ULINK:PROFile:AUTO:PUCCh:SHIFt?	1052
[:SENSe]:EVM:ULINK:PROFile:AUTO:PUCCh:SSLot <integer>	1054
[:SENSe]:EVM:ULINK:PROFile:AUTO:PUCCh:SSLot?	1054
[:SENSe]:EVM:ULINK:PROFile:AUTO:PUCCh:SSLot:AUTO OFF ON 0 1	1054
[:SENSe]:EVM:ULINK:PROFile:AUTO:PUCCh:SSLot:AUTO?	1054
[:SENSe]:EVM:ULINK:PROFile:AUTO:PUSCh INCLude EXCLude	978
[:SENSe]:EVM:ULINK:PROFile:AUTO:PUSCh?	978
[:SENSe]:EVM:ULINK:PROFile:AUTO:PUSCh:ACTive OFF ON 0 1	999
[:SENSe]:EVM:ULINK:PROFile:AUTO:PUSCh:ACTive?	999
[:SENSe]:EVM:ULINK:PROFile:AUTO:PUSCh:DMRS INCLude EXCLude	980
[:SENSe]:EVM:ULINK:PROFile:AUTO:PUSCh:DMRS?	980
[:SENSe]:EVM:ULINK:PROFile:AUTO:PUSCh:DMRS:CSHift <integer>	1027
[:SENSe]:EVM:ULINK:PROFile:AUTO:PUSCh:DMRS:CSHift?	1027
[:SENSe]:EVM:ULINK:PROFile:AUTO:PUSCh:DMRS:GROup <integer>	1023
[:SENSe]:EVM:ULINK:PROFile:AUTO:PUSCh:DMRS:GROup?	1023
[:SENSe]:EVM:ULINK:PROFile:AUTO:PUSCh:DMRS:ONE <integer>	1001
[:SENSe]:EVM:ULINK:PROFile:AUTO:PUSCh:DMRS:ONE?	1001
[:SENSe]:EVM:ULINK:PROFile:AUTO:PUSCh:DMRS:PARAmS OFF ON 0 1	1000
[:SENSe]:EVM:ULINK:PROFile:AUTO:PUSCh:DMRS:PARAmS?	1000
[:SENSe]:EVM:ULINK:PROFile:AUTO:PUSCh:DMRS:PWRBoost <rel_amp>	1030
[:SENSe]:EVM:ULINK:PROFile:AUTO:PUSCh:DMRS:PWRBoost?	1030
[:SENSe]:EVM:ULINK:PROFile:AUTO:PUSCh:DMRS:SEQuence <integer>	1025
[:SENSe]:EVM:ULINK:PROFile:AUTO:PUSCh:DMRS:SEQuence?	1025

List of Commands

[:SENSe]:EVM:ULINK:PROFile:AUTO:PUSCh:DMRS:TWO <integer>	1003
[:SENSe]:EVM:ULINK:PROFile:AUTO:PUSCh:DMRS:TWO?	1003
[:SENSe]:EVM:ULINK:PROFile:AUTO:PUSCh:DSS <integer>	1004
[:SENSe]:EVM:ULINK:PROFile:AUTO:PUSCh:DSS?	1004
[:SENSe]:EVM:ULINK:PROFile:AUTO:PUSCh:FHOPping OFF T1ISF00 T1ISF00 T1ISF01 T1ISF01 T1ISF10 T1ISF10 T2ISF T2ISF	1006
[:SENSe]:EVM:ULINK:PROFile:AUTO:PUSCh:FHOPping?	1006
[:SENSe]:EVM:ULINK:PROFile:AUTO:PUSCh:MODulation:TYPE QPSK QAM16 QAM64	1018
[:SENSe]:EVM:ULINK:PROFile:AUTO:PUSCh:MODulation:TYPE?	1018
[:SENSe]:EVM:ULINK:PROFile:AUTO:PUSCh:NRBHo <integer>	1008
[:SENSe]:EVM:ULINK:PROFile:AUTO:PUSCh:NRBHo?	1008
[:SENSe]:EVM:ULINK:PROFile:AUTO:PUSCh:NSB <integer>	1010
[:SENSe]:EVM:ULINK:PROFile:AUTO:PUSCh:NSB?	1010
[:SENSe]:EVM:ULINK:PROFile:AUTO:PUSCh:PWRBoost <rel_ampl>	1021
[:SENSe]:EVM:ULINK:PROFile:AUTO:PUSCh:PWRBoost?	1021
[:SENSe]:EVM:ULINK:PROFile:AUTO:PUSCh:RB:END <integer>	1016
[:SENSe]:EVM:ULINK:PROFile:AUTO:PUSCh:RB:END?	1016
[:SENSe]:EVM:ULINK:PROFile:AUTO:PUSCh:RB:STARt <integer>	1014
[:SENSe]:EVM:ULINK:PROFile:AUTO:PUSCh:RB:STARt?	1014
[:SENSe]:EVM:ULINK:PROFile:AUTO:PUSCh:SSLot <integer>	1012
[:SENSe]:EVM:ULINK:PROFile:AUTO:PUSCh:SSLot?	1012
[:SENSe]:EVM:ULINK:PROFile:AUTO:PUSCh:SSLot:AUTO OFF ON 0 1	1012
[:SENSe]:EVM:ULINK:PROFile:AUTO:PUSCh:SSLot:AUTO?	1012
[:SENSe]:EVM:ULINK:PROFile:AUTO:RNTI <integer>	993
[:SENSe]:EVM:ULINK:PROFile:AUTO:RNTI?	993
[:SENSe]:EVM:ULINK:PROFile:AUTO:SFNumber <integer>	994
[:SENSe]:EVM:ULINK:PROFile:AUTO:SFNumber?	994
[:SENSe]:EVM:ULINK:PROFile:AUTO:SRS INCLude EXCLude	984
[:SENSe]:EVM:ULINK:PROFile:AUTO:SRS?	984
[:SENSe]:EVM:ULINK:PROFile:AUTO:SRS:ACTive OFF ON 0 1	1100
[:SENSe]:EVM:ULINK:PROFile:AUTO:SRS:ACTive?	1100

List of Commands

[[:SENSe]:EVM:ULINK:PROFile:AUTO:SRS:BCONfig <integer>	1103
[[:SENSe]:EVM:ULINK:PROFile:AUTO:SRS:BCONfig?	1103
[[:SENSe]:EVM:ULINK:PROFile:AUTO:SRS:BWIDth <integer>	1104
[[:SENSe]:EVM:ULINK:PROFile:AUTO:SRS:BWIDth?	1104
[[:SENSe]:EVM:ULINK:PROFile:AUTO:SRS:CINDeX <integer>	1111
[[:SENSe]:EVM:ULINK:PROFile:AUTO:SRS:CINDeX?	1111
[[:SENSe]:EVM:ULINK:PROFile:AUTO:SRS:CSHift <integer>	1101
[[:SENSe]:EVM:ULINK:PROFile:AUTO:SRS:CSHift?	1101
[[:SENSe]:EVM:ULINK:PROFile:AUTO:SRS:FDPosition <integer>.	1107
[[:SENSe]:EVM:ULINK:PROFile:AUTO:SRS:FDPosition?	1107
[[:SENSe]:EVM:ULINK:PROFile:AUTO:SRS:HBWidth <integer>	1106
[[:SENSe]:EVM:ULINK:PROFile:AUTO:SRS:HBWidth?	1106
[[:SENSe]:EVM:ULINK:PROFile:AUTO:SRS:MUPTs OFF ON 0 1.	1114
[[:SENSe]:EVM:ULINK:PROFile:AUTO:SRS:MUPTs?	1114
[[:SENSe]:EVM:ULINK:PROFile:AUTO:SRS:NRA:SONe <integer>	1115
[[:SENSe]:EVM:ULINK:PROFile:AUTO:SRS:NRA:SONe?	1115
[[:SENSe]:EVM:ULINK:PROFile:AUTO:SRS:NRA:SSIX <integer>.	1117
[[:SENSe]:EVM:ULINK:PROFile:AUTO:SRS:NRA:SSIX?	1117
[[:SENSe]:EVM:ULINK:PROFile:AUTO:SRS:PWRBoost <rel_amp>	1110
[[:SENSe]:EVM:ULINK:PROFile:AUTO:SRS:PWRBoost?	1110
[[:SENSe]:EVM:ULINK:PROFile:AUTO:SRS:SFConfig <integer>	1109
[[:SENSe]:EVM:ULINK:PROFile:AUTO:SRS:SFConfig?	1109
[[:SENSe]:EVM:ULINK:PROFile:AUTO:SRS:SSLot <integer>.	1113
[[:SENSe]:EVM:ULINK:PROFile:AUTO:SRS:SSLot?	1113
[[:SENSe]:EVM:ULINK:PROFile:AUTO:SRS:SSLot:AUTO OFF ON 0 1.	1113
[[:SENSe]:EVM:ULINK:PROFile:AUTO:SRS:SSLot:AUTO?	1113
[[:SENSe]:EVM:ULINK:PROFile:AUTO:SRS:TCOMb <integer>	1105
[[:SENSe]:EVM:ULINK:PROFile:AUTO:SRS:TCOMb?	1105
[[:SENSe]:EVM:ULINK:PROFile:CLEar	1124
[[:SENSe]:EVM:ULINK:PROFile:COUNt?	1124
[[:SENSe]:EVM:ULINK:PROFile:EXCLude:ALL.	976

List of Commands

[:SENSe]:EVM:ULINK:PROFile:IGNore	1124
[:SENSe]:EVM:ULINK:PROFile:INCLude:ALL	976
[:SENSe]:EVM:ULINK:PROFile:UPDate	1124
[:SENSe]:EVM:ULINK:PROFile:USER<n>:CID <integer>	991
[:SENSe]:EVM:ULINK:PROFile:USER<n>:CID?	991
[:SENSe]:EVM:ULINK:PROFile:USER<n>:DELeTe	991
[:SENSe]:EVM:ULINK:PROFile:USER<n>:HOPPIng:GRoup OFF ON 0 1	995
[:SENSe]:EVM:ULINK:PROFile:USER<n>:HOPPIng:GRoup?	995
[:SENSe]:EVM:ULINK:PROFile:USER<n>:HOPPIng:SEQuence OFF ON 0 1	996
[:SENSe]:EVM:ULINK:PROFile:USER<n>:HOPPIng:SEQuence?	996
[:SENSe]:EVM:ULINK:PROFile:USER<n>:PRACH INCLude EXCLude	983
[:SENSe]:EVM:ULINK:PROFile:USER<n>:PRACH?	983
[:SENSe]:EVM:ULINK:PROFile:USER<n>:PRACH:CINDeX <integer>	1090
[:SENSe]:EVM:ULINK:PROFile:USER<n>:PRACH:CINDeX?	1090
[:SENSe]:EVM:ULINK:PROFile:USER<n>:PRACH:CSSet UNReStricted RESTRicted	1093
[:SENSe]:EVM:ULINK:PROFile:USER<n>:PRACH:CSSet?	1093
[:SENSe]:EVM:ULINK:PROFile:USER<n>:PRACH:LRSindex <integer>	1092
[:SENSe]:EVM:ULINK:PROFile:USER<n>:PRACH:LRSindex?	1092
[:SENSe]:EVM:ULINK:PROFile:USER<n>:PRACH:NCSConfig <integer>	1094
[:SENSe]:EVM:ULINK:PROFile:USER<n>:PRACH:NCSConfig?	1094
[:SENSe]:EVM:ULINK:PROFile:USER<n>:PRACH:NRAPrb <integer>	1089
[:SENSe]:EVM:ULINK:PROFile:USER<n>:PRACH:NRAPrb?	1089
[:SENSe]:EVM:ULINK:PROFile:USER<n>:PRACH:PINDeX <integer>	1096
[:SENSe]:EVM:ULINK:PROFile:USER<n>:PRACH:PINDeX?	1096
[:SENSe]:EVM:ULINK:PROFile:USER<n>:PRACH:PWRBoost <rel_amp>	1097
[:SENSe]:EVM:ULINK:PROFile:USER<n>:PRACH:PWRBoost?	1097
[:SENSe]:EVM:ULINK:PROFile:USER<n>:PRACH:SRESorce <integer>	1098
[:SENSe]:EVM:ULINK:PROFile:USER<n>:PRACH:SRESorce?	1098
[:SENSe]:EVM:ULINK:PROFile:USER<n>:PUCCh INCLude EXCLude	980
[:SENSe]:EVM:ULINK:PROFile:USER<n>:PUCCh?	980
[:SENSe]:EVM:ULINK:PROFile:USER<n>:PUCCh:ADD:SLOT<integer>	1085

List of Commands

[[:SENSe]:EVM:ULINK:PROFile:USER<n>:PUCCh:COUNT?	1124
[[:SENSe]:EVM:ULINK:PROFile:USER<n>:PUCCh:CSHift <integer>	1062
[[:SENSe]:EVM:ULINK:PROFile:USER<n>:PUCCh:CSHift?	1062
[[:SENSe]:EVM:ULINK:PROFile:USER<n>:PUCCh:CSHift:COUPlE OFF ON 0 1	1063
[[:SENSe]:EVM:ULINK:PROFile:USER<n>:PUCCh:CSHift:COUPlE?	1063
[[:SENSe]:EVM:ULINK:PROFile:USER<n>:PUCCh:DMRS INCLUde EXCLUde	981
[[:SENSe]:EVM:ULINK:PROFile:USER<n>:PUCCh:DMRS?	981
[[:SENSe]:EVM:ULINK:PROFile:USER<n>:PUCCh:DMRS:GROUp <integer>	1069
[[:SENSe]:EVM:ULINK:PROFile:USER<n>:PUCCh:DMRS:GROUp?	1069
[[:SENSe]:EVM:ULINK:PROFile:USER<n>:PUCCh:DMRS:GROUp:COUPlE OFF ON 0 1	1070
[[:SENSe]:EVM:ULINK:PROFile:USER<n>:PUCCh:DMRS:GROUp:COUPlE?	1070
[[:SENSe]:EVM:ULINK:PROFile:USER<n>:PUCCh:DMRS:PARAmS OFF ON 0 1	1045
[[:SENSe]:EVM:ULINK:PROFile:USER<n>:PUCCh:DMRS:PARAmS?	1045
[[:SENSe]:EVM:ULINK:PROFile:USER<n>:PUCCh:DMRS:PWRBoost <rel_amp >	1071
[[:SENSe]:EVM:ULINK:PROFile:USER<n>:PUCCh:DMRS:PWRBoost?	1071
[[:SENSe]:EVM:ULINK:PROFile:USER<n>:PUCCh:DMRS:PWRBoost:COUPlE OFF ON 0 1	1072
[[:SENSe]:EVM:ULINK:PROFile:USER<n>:PUCCh:DMRS:PWRBoost:COUPlE?	1072
[[:SENSe]:EVM:ULINK:PROFile:USER<n>:PUCCh:FORMAt T1 T1A T1B T2 T2A T2B T1S T1AS T1BS	1058
[[:SENSe]:EVM:ULINK:PROFile:USER<n>:PUCCh:FORMAt?	1058
[[:SENSe]:EVM:ULINK:PROFile:USER<n>:PUCCh:FORMAt:COUPlE OFF ON 0 1	1061
[[:SENSe]:EVM:ULINK:PROFile:USER<n>:PUCCh:FORMAt:COUPlE?	1061
[[:SENSe]:EVM:ULINK:PROFile:USER<n>:PUCCh:NCS:ONE <integer>	1048
[[:SENSe]:EVM:ULINK:PROFile:USER<n>:PUCCh:NCS:ONE?	1048
[[:SENSe]:EVM:ULINK:PROFile:USER<n>:PUCCh:N:ONE <integer>	1073
[[:SENSe]:EVM:ULINK:PROFile:USER<n>:PUCCh:N:ONE?	1073
[[:SENSe]:EVM:ULINK:PROFile:USER<n>:PUCCh:N:ONE:COUPlE OFF ON 0 1	1074
[[:SENSe]:EVM:ULINK:PROFile:USER<n>:PUCCh:N:ONE:COUPlE?	1074
[[:SENSe]:EVM:ULINK:PROFile:USER<n>:PUCCh:NRB:TWO <integer>	1047
[[:SENSe]:EVM:ULINK:PROFile:USER<n>:PUCCh:NRB:TWO?	1047
[[:SENSe]:EVM:ULINK:PROFile:USER<n>:PUCCh:N:TWO <integer>	1050
[[:SENSe]:EVM:ULINK:PROFile:USER<n>:PUCCh:N:TWO?	1050

List of Commands

[:SENSe]:EVM:ULINK:PROFile:USER<n>:PUCCh:OS INDeX0 INDeX1 INDeX2	1063
[:SENSe]:EVM:ULINK:PROFile:USER<n>:PUCCh:OS?	1063
[:SENSe]:EVM:ULINK:PROFile:USER<n>:PUCCh:OS:COUPlE OFF ON 0 1 [:SENSe]:EVM:ULINK:PRO- File:USER<n>:PUCCh:OS:COUPlE?	1066
[:SENSe]:EVM:ULINK:PROFile:USER<n>:PUCCh:PWRBoost <rel_amp>	1067
[:SENSe]:EVM:ULINK:PROFile:USER<n>:PUCCh:PWRBoost?	1067
[:SENSe]:EVM:ULINK:PROFile:USER<n>:PUCCh:PWRBoost:COUPlE OFF ON 0 1	1068
[:SENSe]:EVM:ULINK:PROFile:USER<n>:PUCCh:PWRBoost:COUPlE?	1068
[:SENSe]:EVM:ULINK:PROFile:USER<n>:PUCCh:RB <integer>	1056
[:SENSe]:EVM:ULINK:PROFile:USER<n>:PUCCh:RB?	1056
[:SENSe]:EVM:ULINK:PROFile:USER<n>:PUCCh:RB:COUPlE OFF ON 0 1	1057
[:SENSe]:EVM:ULINK:PROFile:USER<n>:PUCCh:RB:COUPlE?	1057
[:SENSe]:EVM:ULINK:PROFile:USER<n>:PUCCh:SHIFt <integer>	1051
[:SENSe]:EVM:ULINK:PROFile:USER<n>:PUCCh:SHIFt?	1051
[:SENSe]:EVM:ULINK:PROFile:USER<n>:PUCCh:SLOT<m>:CSHift <integer>	1079
[:SENSe]:EVM:ULINK:PROFile:USER<n>:PUCCh:SLOT<m>:CSHift?	1079
[:SENSe]:EVM:ULINK:PROFile:USER<n>:PUCCh:SLOT<m>:DELete	1086
[:SENSe]:EVM:ULINK:PROFile:USER<n>:PUCCh:SLOT<m>:DMRS:GROUp <integer>	1082
[:SENSe]:EVM:ULINK:PROFile:USER<n>:PUCCh:SLOT<m>:DMRS:GROUp?	1082
[:SENSe]:EVM:ULINK:PROFile:USER<n>:PUCCh:SLOT<m>:DMRS:PWRBoost <rel_amp>	1083
[:SENSe]:EVM:ULINK:PROFile:USER<n>:PUCCh:SLOT<m>:DMRS:PWRBoost?	1083
[:SENSe]:EVM:ULINK:PROFile:USER<n>:PUCCh:SLOT<m>:FORMat T1 T1A T1B T2 T2A T2B T1S T1AS T1BS	1076
[:SENSe]:EVM:ULINK:PROFile:USER<n>:PUCCh:SLOT<m>:FORMat?	1076
[:SENSe]:EVM:ULINK:PROFile:USER<n>:PUCCh:SLOT<m>:N:ONE <integer>	1084
[:SENSe]:EVM:ULINK:PROFile:USER<n>:PUCCh:SLOT<m>:N:ONE?	1084
[:SENSe]:EVM:ULINK:PROFile:USER<n>:PUCCh:SLOT<m>:OS INDeX0 INDeX1 INDeX2	1080
[:SENSe]:EVM:ULINK:PROFile:USER<n>:PUCCh:SLOT<m>:OS?	1080
[:SENSe]:EVM:ULINK:PROFile:USER<n>:PUCCh:SLOT<m>:POSition?	1087
[:SENSe]:EVM:ULINK:PROFile:USER<n>:PUCCh:SLOT<m>:PWRBoost <rel_amp>	1081
[:SENSe]:EVM:ULINK:PROFile:USER<n>:PUCCh:SLOT<m>:PWRBoost?	1081
[:SENSe]:EVM:ULINK:PROFile:USER<n>:PUCCh:SLOT<m>:RB <integer>	1075

List of Commands

[:SENSe]:EVM:ULINK:PROFile:USER<n>:PUCCh:SLOT<m>:RB?	1075
[:SENSe]:EVM:ULINK:PROFile:USER<n>:PUCCh:SSLot <integer>	1053
[:SENSe]:EVM:ULINK:PROFile:USER<n>:PUCCh:SSLot?	1053
[:SENSe]:EVM:ULINK:PROFile:USER<n>:PUCCh:SSLot:AUTO OFF ON 0 1	1053
[:SENSe]:EVM:ULINK:PROFile:USER<n>:PUCCh:SSLot:AUTO?	1053
[:SENSe]:EVM:ULINK:PROFile:USER<n>:PUSCh: FHOPping OFF T1HSF0 T1HSF00 T1HSF01 T1HSF10 T1HSF10 T1HSF10 T2ISF T2IISF	1005
[:SENSe]:EVM:ULINK:PROFile:USER<n>:PUSCh INCLude EXCLude	978
[:SENSe]:EVM:ULINK:PROFile:USER<n>:PUSCh?	978
[:SENSe]:EVM:ULINK:PROFile:USER<n>:PUSCh:ADD:SLOT <integer>	1041
[:SENSe]:EVM:ULINK:PROFile:USER<n>:PUSCh:COUNt?	1125
[:SENSe]:EVM:ULINK:PROFile:USER<n>:PUSCh:CTNB EVEN ODD	1031
[:SENSe]:EVM:ULINK:PROFile:USER<n>:PUSCh:CTNB?	1031
[:SENSe]:EVM:ULINK:PROFile:USER<n>:PUSCh:CTNB:COUPlE OFF ON 0 1	1032
[:SENSe]:EVM:ULINK:PROFile:USER<n>:PUSCh:CTNB:COUPlE?	1032
[:SENSe]:EVM:ULINK:PROFile:USER<n>:PUSCh:DMRS INCLude EXCLude	979
[:SENSe]:EVM:ULINK:PROFile:USER<n>:PUSCh:DMRS?	979
[:SENSe]:EVM:ULINK:PROFile:USER<n>:PUSCh:DMRS:CSHift <integer>	1027
[:SENSe]:EVM:ULINK:PROFile:USER<n>:PUSCh:DMRS:CSHift?	1027
[:SENSe]:EVM:ULINK:PROFile:USER<n>:PUSCh:DMRS:CSHift:COUPlE OFF ON 0 1	1028
[:SENSe]:EVM:ULINK:PROFile:USER<n>:PUSCh:DMRS:CSHift:COUPlE?	1028
[:SENSe]:EVM:ULINK:PROFile:USER<n>:PUSCh:DMRS:GRoup <integer>	1022
[:SENSe]:EVM:ULINK:PROFile:USER<n>:PUSCh:DMRS:GRoup?	1022
[:SENSe]:EVM:ULINK:PROFile:USER<n>:PUSCh:DMRS:GRoup:COUPlE OFF ON 0 1	1024
[:SENSe]:EVM:ULINK:PROFile:USER<n>:PUSCh:DMRS:GRoup:COUPlE?	1024
[:SENSe]:EVM:ULINK:PROFile:USER<n>:PUSCh:DMRS:ONE <integer>	1000
[:SENSe]:EVM:ULINK:PROFile:USER<n>:PUSCh:DMRS:ONE?	1000
[:SENSe]:EVM:ULINK:PROFile:USER<n>:PUSCh:DMRS:PARAmS OFF ON 0 1	999
[:SENSe]:EVM:ULINK:PROFile:USER<n>:PUSCh:DMRS:PARAmS?	999
[:SENSe]:EVM:ULINK:PROFile:USER<n>:PUSCh:DMRS:PWRBoost <rel_ampl>	1029
[:SENSe]:EVM:ULINK:PROFile:USER<n>:PUSCh:DMRS:PWRBoost?	1029

List of Commands

[:SENSe]:EVM:ULINK:PROFile:USER<n>:PUSCh:DMRS:PWRBoost:COUPle OFF ON 0 1	1030
[:SENSe]:EVM:ULINK:PROFile:USER<n>:PUSCh:DMRS:PWRBoost:COUPle	1030
[:SENSe]:EVM:ULINK:PROFile:USER<n>:PUSCh:DMRS:SEQuence <integer>	1025
[:SENSe]:EVM:ULINK:PROFile:USER<n>:PUSCh:DMRS:SEQuence?	1025
[:SENSe]:EVM:ULINK:PROFile:USER<n>:PUSCh:DMRS:SEQuence:COUPle OFF ON 0 1	1026
[:SENSe]:EVM:ULINK:PROFile:USER<n>:PUSCh:DMRS:SEQuence:COUPle?	1026
[:SENSe]:EVM:ULINK:PROFile:USER<n>:PUSCh:DMRS:TWO <integer>	1002
[:SENSe]:EVM:ULINK:PROFile:USER<n>:PUSCh:DMRS:TWO?	1002
[:SENSe]:EVM:ULINK:PROFile:USER<n>:PUSCh:DSS <integer>	1003
[:SENSe]:EVM:ULINK:PROFile:USER<n>:PUSCh:DSS?	1003
[:SENSe]:EVM:ULINK:PROFile:USER<n>:PUSCh:FHOPping?	1005
[:SENSe]:EVM:ULINK:PROFile:USER<n>:PUSCh:MODulation:TYPE QPSK QAM16 QAM64	1018
[:SENSe]:EVM:ULINK:PROFile:USER<n>:PUSCh:MODulation:TYPE?	1018
[:SENSe]:EVM:ULINK:PROFile:USER<n>:PUSCh:MODulation:TYPE:COUPle OFF ON 0 1	1020
[:SENSe]:EVM:ULINK:PROFile:USER<n>:PUSCh:MODulation:TYPE:COUPle?	1020
[:SENSe]:EVM:ULINK:PROFile:USER<n>:PUSCh:NRBHo:<integer>	1007
[:SENSe]:EVM:ULINK:PROFile:USER<n>:PUSCh:NRBHo?	1007
[:SENSe]:EVM:ULINK:PROFile:USER<n>:PUSCh:NSB <integer>	1009
[:SENSe]:EVM:ULINK:PROFile:USER<n>:PUSCh:NSB?	1009
[:SENSe]:EVM:ULINK:PROFile:USER<n>:PUSCh:PWRBoost <rel_ampl>	1020
[:SENSe]:EVM:ULINK:PROFile:USER<n>:PUSCh:PWRBoost?	1020
[:SENSe]:EVM:ULINK:PROFile:USER<n>:PUSCh:PWRBoost:COUPle OFF ON 0 1	1022
[:SENSe]:EVM:ULINK:PROFile:USER<n>:PUSCh:PWRBoost:COUPle	1022
[:SENSe]:EVM:ULINK:PROFile:USER<n>:PUSCh:RB:END <integer>	1015
[:SENSe]:EVM:ULINK:PROFile:USER<n>:PUSCh:RB:END?	1015
[:SENSe]:EVM:ULINK:PROFile:USER<n>:PUSCh:RB:END:COUPle OFF ON 0 1	1017
[:SENSe]:EVM:ULINK:PROFile:USER<n>:PUSCh:RB:END:COUPle?	1017
[:SENSe]:EVM:ULINK:PROFile:USER<n>:PUSCh:RB:START <integer>	1013
[:SENSe]:EVM:ULINK:PROFile:USER<n>:PUSCh:RB:START?	1013
[:SENSe]:EVM:ULINK:PROFile:USER<n>:PUSCh:RB:START:COUPle OFF ON 0 1	1014
[:SENSe]:EVM:ULINK:PROFile:USER<n>:PUSCh:RB:START:COUPle?	1014

List of Commands

[[:SENSe]:EVM:ULINK:PROFile:USER<n>:PUSCh:SLOT<m>:CTNB OFF ON 0 1	1040
[[:SENSe]:EVM:ULINK:PROFile:USER<n>:PUSCh:SLOT<m>:CTNB?	1040
[[:SENSe]:EVM:ULINK:PROFile:USER<n>:PUSCh:SLOT<m>:DELete	1042
[[:SENSe]:EVM:ULINK:PROFile:USER<n>:PUSCh:SLOT<m>:DMRS:CSHift <integer>	1039
[[:SENSe]:EVM:ULINK:PROFile:USER<n>:PUSCh:SLOT<m>:DMRS:CSHift?	1039
[[:SENSe]:EVM:ULINK:PROFile:USER<n>:PUSCh:SLOT<m>:DMRS:GROup <integer>	1037
[[:SENSe]:EVM:ULINK:PROFile:USER<n>:PUSCh:SLOT<m>:DMRS:GROup?	1037
[[:SENSe]:EVM:ULINK:PROFile:USER<n>:PUSCh:SLOT<m>:DMRS:PWRBoost <rel_amp>	1039
[[:SENSe]:EVM:ULINK:PROFile:USER<n>:PUSCh:SLOT<m>:DMRS:PWRBoost?	1039
[[:SENSe]:EVM:ULINK:PROFile:USER<n>:PUSCh:SLOT<m>:DMRS:SEQuence <integer>	1038
[[:SENSe]:EVM:ULINK:PROFile:USER<n>:PUSCh:SLOT<m>:DMRS:SEQuence?	1038
[[:SENSe]:EVM:ULINK:PROFile:USER<n>:PUSCh:SLOT<m>:MODulation:TYPE QPSK QAM16 QAM64	1035
[[:SENSe]:EVM:ULINK:PROFile:USER<n>:PUSCh:SLOT<m>:MODulation:TYPE?	1035
[[:SENSe]:EVM:ULINK:PROFile:USER<n>:PUSCh:SLOT<m>:POSition?	1043
[[:SENSe]:EVM:ULINK:PROFile:USER<n>:PUSCh:SLOT<m>:PWRBoost <rel_amp>	1036
[[:SENSe]:EVM:ULINK:PROFile:USER<n>:PUSCh:SLOT<m>:PWRBoost?	1036
[[:SENSe]:EVM:ULINK:PROFile:USER<n>:PUSCh:SLOT<m>:RB:END <integer>	1033
[[:SENSe]:EVM:ULINK:PROFile:USER<n>:PUSCh:SLOT<m>:RB:END?	1033
[[:SENSe]:EVM:ULINK:PROFile:USER<n>:PUSCh:SLOT<m>:RB:STARt <integer>	1032
[[:SENSe]:EVM:ULINK:PROFile:USER<n>:PUSCh:SLOT<m>:RB:STARt?	1032
[[:SENSe]:EVM:ULINK:PROFile:USER<n>:PUSCh:SSLot:<integer>	1011
[[:SENSe]:EVM:ULINK:PROFile:USER<n>:PUSCh:SSLot?	1011
[[:SENSe]:EVM:ULINK:PROFile:USER<n>:PUSCh:SSLot:AUTO OFF ON 0 1	1011
[[:SENSe]:EVM:ULINK:PROFile:USER<n>:PUSCh:SSLot:AUTO?	1011
[[:SENSe]:EVM:ULINK:PROFile:USER<n>:RNTI <integer>	992
[[:SENSe]:EVM:ULINK:PROFile:USER<n>:RNTI?	992
[[:SENSe]:EVM:ULINK:PROFile:USER<n>:SFNumber <integer>	994
[[:SENSe]:EVM:ULINK:PROFile:USER<n>:SFNumber?	994
[[:SENSe]:EVM:ULINK:PROFile:USER<n>:SRS INCLude EXCLude	984
[[:SENSe]:EVM:ULINK:PROFile:USER<n>:SRS?	984
[[:SENSe]:EVM:ULINK:PROFile:USER<n>:SRS:BCONfig <integer>	1102

List of Commands

[:SENSe]:EVM:ULINK:PROFile:USER<n>:SRS:BConFig?	1102
[:SENSe]:EVM:ULINK:PROFile:USER<n>:SRS:BWIDth <integer>	1103
[:SENSe]:EVM:ULINK:PROFile:USER<n>:SRS:BWIDth?	1103
[:SENSe]:EVM:ULINK:PROFile:USER<n>:SRS:CINDeX <integer>	1111
[:SENSe]:EVM:ULINK:PROFile:USER<n>:SRS:CINDeX?	1111
[:SENSe]:EVM:ULINK:PROFile:USER<n>:SRS:CSHift <integer>	1101
[:SENSe]:EVM:ULINK:PROFile:USER<n>:SRS:CSHift?	1101
[:SENSe]:EVM:ULINK:PROFile:USER<n>:SRS:FDPosition <integer>	1107
[:SENSe]:EVM:ULINK:PROFile:USER<n>:SRS:FDPosition?	1107
[:SENSe]:EVM:ULINK:PROFile:USER<n>:SRS:HBWidth <integer>	1106
[:SENSe]:EVM:ULINK:PROFile:USER<n>:SRS:HBWidth?	1106
[:SENSe]:EVM:ULINK:PROFile:USER<n>:SRS:MUPTs OFF ON 0 1 [:SENSe]:EVM:ULINK:PROFile:US- ER<n>:SRS:MUPTs?	1114
[:SENSe]:EVM:ULINK:PROFile:USER<n>:SRS:NRA:SONe <integer>	1115
[:SENSe]:EVM:ULINK:PROFile:USER<n>:SRS:NRA:SONe?	1115
[:SENSe]:EVM:ULINK:PROFile:USER<n>:SRS:NRA:SSIX <integer>	1116
[:SENSe]:EVM:ULINK:PROFile:USER<n>:SRS:NRA:SSIX?	1116
[:SENSe]:EVM:ULINK:PROFile:USER<n>:SRS:PWRBoost <rel_amp>	1109
[:SENSe]:EVM:ULINK:PROFile:USER<n>:SRS:PWRBoost?	1109
[:SENSe]:EVM:ULINK:PROFile:USER<n>:SRS:SFCOnfig <integer>	1108
[:SENSe]:EVM:ULINK:PROFile:USER<n>:SRS:SFCOnfig?	1108
[:SENSe]:EVM:ULINK:PROFile:USER<n>:SRS:SSLot <integer>	1112
[:SENSe]:EVM:ULINK:PROFile:USER<n>:SRS:SSLot?	1112
[:SENSe]:EVM:ULINK:PROFile:USER<n>:SRS:SSLot:AUTO OFF ON 0 1	1112
[:SENSe]:EVM:ULINK:PROFile:USER<n>:SRS:SSLot:AUTO?	1112
[:SENSe]:EVM:ULINK:PROFile:USER<n>:SRS:TCOMb <integer>	1104
[:SENSe]:EVM:ULINK:PROFile:USER<n>:SRS:TCOMb?	1104
[:SENSe]:EVM:ULINK:PROFile:USER1 50:PRACH:ACTive OFF ON 0 1	1088
[:SENSe]:EVM:ULINK:PROFile:USER1 50:PRACH:ACTive?	1088
[:SENSe]:EVM:ULINK:PROFile:USER1 50:PUCCh:ACTive OFF ON 0 1	1044
[:SENSe]:EVM:ULINK:PROFile:USER1 50:PUCCh:ACTive?	1044

List of Commands

[[:SENSe]:EVM:ULINK:PROFile:USER1 50:PUSCh:ACTive OFF ON 0 1	998
[[:SENSe]:EVM:ULINK:PROFile:USER1 50:PUSCh:ACTive?	998
[[:SENSe]:EVM:ULINK:PROFile:USER1 50:PUSCh:CTNB EVEN ODD	1031
[[:SENSe]:EVM:ULINK:PROFile:USER1 50:PUSCh:CTNB?	1031
[[:SENSe]:EVM:ULINK:PROFile:USER1 50:SRS:ACTive OFF ON 0 1	1100
[[:SENSe]:EVM:ULINK:PROFile:USER1 50:SRS:ACTive?	1100
[[:SENSe]:EVM:ULINK:SYNC:CPLength AUTO NORMAl EXTended	1148
[[:SENSe]:EVM:ULINK:SYNC:CPLength?	1148
[[:SENSe]:EVM:ULINK:SYNC:CPLength:AUTO OFF ON 0 1	1148
[[:SENSe]:EVM:ULINK:SYNC:CPLength:AUTO?	1148
[[:SENSe]:EVM:ULINK:SYNC:HSSHift OFF ON 0 1	878
[[:SENSe]:EVM:ULINK:SYNC:HSSHift?	878
[[:SENSe]:EVM:ULINK:SYNC:PDSWap OFF ON 0 1	878
[[:SENSe]:EVM:ULINK:SYNC:PDSWap?	878
[[:SENSe]:EVM:ULINK:SYNC:TYPE RS PUCCh SRS PRACH	876
[[:SENSe]:EVM:ULINK:SYNC:TYPE?	876
[[:SENSe]:EVM:WINDow:LENGth GPP CUSTom	1158
[[:SENSe]:EVM:WINDow:LENGth?	1158
[[:SENSe]:EVM:WINDow:LENGth:CUSTom <int>	1158
[[:SENSe]:EVM:WINDow:LENGth:CUSTom?	1158
[[:SENSe]:FCAPture:BLOCK <integer>	1805
[[:SENSe]:FCAPture:BLOCK?	1805
[[:SENSe]:FCAPture:LENGth <integer>	1804
[[:SENSe]:FCAPture:LENGth?	1804
[[:SENSe]:FCAPture:POINter <integer>	1806
[[:SENSe]:FCAPture:POINter?	1806
[[:SENSe]:FCAPture:WLENGth AUTO BIT32 BIT64	1804
[[:SENSe]:FCAPture:WLENGth?	1804
[[:SENSe]:FEED RF AIQ EMIXer	1423
[[:SENSe]:FEED?	1423
[[:SENSe]:FEED:AREFERENCE REF50 REF4800 OFF	1467

List of Commands

[:SENSe]:FEED:AREFERENCE?	1467
[:SENSe]:FEED:DATA INPut STORed RECORded	1474
[:SENSe]:FEED:DATA?	1474
[:SENSe]:FEED:DATA:STORE	1476
[:SENSe]:FEED:IQ:TYPE IQ IONLy QONLy INDEpendent	1454
[:SENSe]:FEED:IQ:TYPE?	1454
[:SENSe]:FEED:RF:PORT[:INPut] RFIN RFIN2 RFIO1 RFIO2	1427
[:SENSe]:FEED:RF:PORT[:INPut]?	1427
[:SENSe]:FREQuency:CENTer <freq>	1415
[:SENSe]:FREQuency:CENTer <freq>	1668
[:SENSe]:FREQuency:CENTer?	1415
[:SENSe]:FREQuency:CENTer?	1668
[:SENSe]:FREQuency:CENTer:STEP:AUTO OFF ON 0 1	1421
[:SENSe]:FREQuency:CENTer:STEP:AUTO OFF ON 0 1	1670
[:SENSe]:FREQuency:CENTer:STEP:AUTO?	1421
[:SENSe]:FREQuency:CENTer:STEP:AUTO?	1670
[:SENSe]:FREQuency:CENTer:STEP[:INCRement] <freq>	1421
[:SENSe]:FREQuency:CENTer:STEP[:INCRement] <freq>	1670
[:SENSe]:FREQuency:CENTer:STEP[:INCRement]?	1421
[:SENSe]:FREQuency:CENTer:STEP[:INCRement]?	1670
[:SENSe]:FREQuency:EMIXer:CENTer <freq>	1419
[:SENSe]:FREQuency:EMIXer:CENTer?	1419
[:SENSe]:FREQuency:IQ:CENTer <freq>	1420
[:SENSe]:FREQuency:IQ:CENTer?	1420
[:SENSe]:FREQuency:RF:CENTer <freq>	1418
[:SENSe]:FREQuency:RF:CENTer?	1418
[:SENSe]:FREQuency:SPAN <freq>	1716
[:SENSe]:FREQuency:SPAN?	1716
[:SENSe]:FREQuency:SPAN:FULL	1717
[:SENSe]:FREQuency:STARt <freq>	1669
[:SENSe]:FREQuency:STARt <freq>	853

List of Commands

[[:SENSe]:FREQuency:START?	1669
[[:SENSe]:FREQuency:START?	853
[[:SENSe]:FREQuency:STOP <freq>.....	1669
[[:SENSe]:FREQuency:STOP <freq>.....	854
[[:SENSe]:FREQuency:STOP?.....	1669
[[:SENSe]:FREQuency:STOP?.....	854
[[:SENSe]:IFPath B10M B25M B40M B140M.....	1705
[[:SENSe]:IFPath?	1705
[[:SENSe]:IFPath:AUTO ON OFF 1 0	1705
[[:SENSe]:IFPath:AUTO?	1705
[[:SENSe]:MIXer:BAND A Q U V W NA ND NE NF NG NJ NK NQ NU NV NW NY NEXT DD DF DG DJ DK DQ DV DW DY DEXT M A ME MU MCOAX	1438
[[:SENSe]:MIXer:BAND?.....	1438
[[:SENSe]:MIXer:BIAS <real>.....	1443
[[:SENSe]:MIXer:BIAS?.....	1443
[[:SENSe]:MIXer:BIAS:STATe OFF ON 0 1	1443
[[:SENSe]:MIXer:BIAS:STATe?.....	1443
[[:SENSe]:MIXer:CIFLoss <rel_ampl>	1450
[[:SENSe]:MIXer:CIFLoss?	1450
[[:SENSe]:MIXer:HARMonic <integer>	1446
[[:SENSe]:MIXer:HARMonic?.....	1446
[[:SENSe]:MIXer:LODoubler ON OFF 0 1.....	1446
[[:SENSe]:MIXer:LODoubler?.....	1446
[[:SENSe]:MIXer:TTYPe SINGLE HARMonic DOUbler.....	1444
[[:SENSe]:MIXer:TTYPE?	1444
[[:SENSe]:MONitor:AVERAge:COUNT <integer>	1242
[[:SENSe]:MONitor:AVERAge:COUNT?	1242
[[:SENSe]:MONitor:AVERAge[:STATe] OFF ON 0 1.....	1242
[[:SENSe]:MONitor:AVERAge[:STATe]?	1242
[[:SENSe]:MONitor:AVERAge:TCONtrol EXPonential REPeat	1243
[[:SENSe]:MONitor:AVERAge:TCONtrol?	1243

List of Commands

[:SENSe]:MONitor:BANDwidth[:RESolution] <freq>	1223
[:SENSe]:MONitor:BANDwidth[:RESolution]?	1223
[:SENSe]:MONitor:BANDwidth[:RESolution]:AUTO OFF ON 0 1	1223
[:SENSe]:MONitor:BANDwidth[:RESolution]:AUTO?	1223
[:SENSe]:MONitor:BANDwidth:VIDeo <bandwidth>	1225
[:SENSe]:MONitor:BANDwidth:VIDeo?	1225
[:SENSe]:MONitor:BANDwidth:VIDeo:AUTO ON OFF 1 0	1225
[:SENSe]:MONitor:BANDwidth:VIDeo:AUTO?	1225
[:SENSe]:MONitor:BANDwidth:VIDeo:RATio <real> [:SENSe]:MONitor:BANDwidth:VIDeo:RATio?	1227
[:SENSe]:MONitor:BANDwidth:VIDeo:RATio:AUTO OFF ON 0 1	1227
[:SENSe]:MONitor:BANDwidth:VIDeo:RATio:AUTO?	1227
[:SENSe]:MONitor:DETEctor:AUTO ON OFF 1 0	1260
[:SENSe]:MONitor:DETEctor:AUTO?	1260
[:SENSe]:MONitor:DETEctor:TRACe AVERAge NEGAtive NORMAl POSitive SAMPle	1259
[:SENSe]:MONitor:DETEctor:TRACe?	1259
[:SENSe]:MONitor:FREQuency:SPAN <freq>	1252
[:SENSe]:MONitor:FREQuency:SPAN?	1252
[:SENSe]:MONitor:FREQuency:SPAN:BANDwidth[:RESolution]:RATio <integer>	1228
[:SENSe]:MONitor:FREQuency:SPAN:BANDwidth[:RESolution]:RATio?	1228
[:SENSe]:MONitor:FREQuency:SPAN:BANDwidth[:RESolution]:RATio:AUTO OFF ON 0 1	1228
[:SENSe]:MONitor:FREQuency:SPAN:BANDwidth[:RESolution]:RATio:AUTO?	1228
[:SENSe]:MONitor:FREQuency:SPAN:FULL	1253
[:SENSe]:MONitor:FREQuency:SPAN:PREVious	1254
[:SENSe]:MONitor:SWEep:POINts <integer>	1256
[:SENSe]:MONitor:SWEep:POINts?	1256
[:SENSe]:MONitor:SWEep:TIME <time>	1255
[:SENSe]:MONitor:SWEep:TIME?	1255
[:SENSe]:MONitor:SWEep:TIME:AUTO OFF ON 0 1	1255
[:SENSe]:MONitor:SWEep:TIME:AUTO?	1255
[:SENSe]:OBWidth:AVERAge:COUNt <integer>	422

List of Commands

[[:SENSe]:OBWidth:AVERage:COUNT?	422
[[:SENSe]:OBWidth:AVERage[:STATe] ON OFF 1 0	422
[[:SENSe]:OBWidth:AVERage[:STATe]?	422
[[:SENSe]:OBWidth:AVERage:TCONtrol EXPonential REPeat	423
[[:SENSe]:OBWidth:AVERage:TCONtrol?	423
[[:SENSe]:OBWidth:BANDwidth[:RESolution] <bandwidth>	407
[[:SENSe]:OBWidth:BANDwidth[:RESolution]?	407
[[:SENSe]:OBWidth:BANDwidth[:RESolution]:AUTO ON OFF 1 0	407
[[:SENSe]:OBWidth:BANDwidth[:RESolution]:AUTO?	407
[[:SENSe]:OBWidth:BANDwidth:SHAPE GAUSSian FLATtop	410
[[:SENSe]:OBWidth:BANDwidth:SHAPE?	410
[[:SENSe]:OBWidth:BANDwidth:VIDeo <bandwidth>	408
[[:SENSe]:OBWidth:BANDwidth:VIDeo?	408
[[:SENSe]:OBWidth:BANDwidth:VIDeo:AUTO ON OFF 1 0	408
[[:SENSe]:OBWidth:BANDwidth:VIDeo:AUTO?	408
[[:SENSe]:OBWidth:DETeCTOR:AUTO ON OFF 1 0	448
[[:SENSe]:OBWidth:DETeCTOR:AUTO?	448
[[:SENSe]:OBWidth:DETeCTOR[:FUNCTion] NORMal AVERagePOSitive SAMPle NEGative	447
[[:SENSe]:OBWidth:DETeCTOR[:FUNCTion]?	447
[[:SENSe]:OBWidth:FREQuency:SPAN <freq>	439
[[:SENSe]:OBWidth:FREQuency:SPAN?	439
[[:SENSe]:OBWidth:FREQuency:SPAN:AUTO ON OFF 0 1	439
[[:SENSe]:OBWidth:FREQuency:SPAN:AUTO?	439
[[:SENSe]:OBWidth:FREQuency:SPAN:FULL	441
[[:SENSe]:OBWidth:FREQuency:SPAN:PREVious	441
[[:SENSe]:OBWidth:IF:GAIN:AUTO[:STATe] ON OFF 1 0	426
[[:SENSe]:OBWidth:IF:GAIN:AUTO[:STATe]?	426
[[:SENSe]:OBWidth:IF:GAIN[:STATe] ON OFF 1 0	427
[[:SENSe]:OBWidth:IF:GAIN[:STATe]?	427
[[:SENSe]:OBWidth:MAXHold ON OFF 1 0	424
[[:SENSe]:OBWidth:MAXHold?	424

List of Commands

[:SENSe]:OBWidth:PERCent <real>	424
[:SENSe]:OBWidth:PERCent?	424
[:SENSe]:OBWidth:SWEep:POINts <integer>	444
[:SENSe]:OBWidth:SWEep:POINts?	444
[:SENSe]:OBWidth:SWEep:TIME <time>	442
[:SENSe]:OBWidth:SWEep:TIME?	442
[:SENSe]:OBWidth:SWEep:TIME:AUTO OFF ON 0 1	442
[:SENSe]:OBWidth:SWEep:TIME:AUTO?	442
[:SENSe]:OBWidth:SWEep:TIME:AUTO:RULEs NORMAl ACCuracy	443
[:SENSe]:OBWidth:SWEep:TIME:AUTO:RULEs?	443
[:SENSe]:OBWidth:XDB <rel_ampl>	425
[:SENSe]:OBWidth:XDB?	425
[:SENSe]:POWer:IQ[:I]:RANGe[:UPPer] <ampl>	1392
[:SENSe]:POWer:IQ[:I]:RANGe[:UPPer]?	1392
[:SENSe]:POWer:IQ:Q:RANGe[:UPPer] <ampl>	1394
[:SENSe]:POWer:IQ:Q:RANGe[:UPPer]?	1394
[:SENSe]:POWer:IQ:RANGe:AUTO OFF ON 0 1	1391
[:SENSe]:POWer:IQ:RANGe:AUTO?	1391
[:SENSe]:POWer[:RF]: RFPSelector [:STATe] 1 0 ON OFF	1429
[:SENSe]:POWer[:RF]: RFPSelector [:STATe]?	1429
[:SENSe]:POWer[:RF]:ATTenuation <rel_ampl>	1382
[:SENSe]:POWer[:RF]:ATTenuation?	1382
[:SENSe]:POWer[:RF]:ATTenuation:AUTO OFF ON 0 1	1382
[:SENSe]:POWer[:RF]:ATTenuation:AUTO?	1382
[:SENSe]:POWer[:RF]:ATTenuation:STEP[:INCRement] 10 dB 2 dB	1389
[:SENSe]:POWer[:RF]:ATTenuation:STEP[:INCRement]?	1389
[:SENSe]:POWer[:RF]:EATTenuation <rel_ampl>	1387
[:SENSe]:POWer[:RF]:EATTenuation?	1387
[:SENSe]:POWer[:RF]:EATTenuation:STATe OFF ON 0 1	1385
[:SENSe]:POWer[:RF]:EATTenuation:STATe?	1385
[:SENSe]:POWer[:RF]:GAIN:BAND LOW FULL	1411

List of Commands

[[:SENSe]:POWer[:RF]:GAIN:BAND?	1411
[[:SENSe]:POWer[:RF]:GAIN[:STATe] OFF ON 0 1	1410
[[:SENSe]:POWer[:RF]:GAIN[:STATe]?	1410
[[:SENSe]:POWer[:RF]:MIXer:RANGe[:UPPer] <real>	1389
[[:SENSe]:POWer[:RF]:MIXer:RANGe[:UPPer]?	1389
[[:SENSe]:POWer[:RF]:MW:PATH STD LNPath MPBypass FULL	1406
[[:SENSe]:POWer[:RF]:MW:PATH?	1406
[[:SENSe]:POWer[:RF]:MW:PRESelector[:STATe] ON OFF 0 1	1410
[[:SENSe]:POWer[:RF]:MW:PRESelector[:STATe]?	1410
[[:SENSe]:POWer[:RF]:PADJust <freq>	1398
[[:SENSe]:POWer[:RF]:PADJust?	1398
[[:SENSe]:POWer[:RF]:PADJust:PRESelector MWAVe MMWave EXternal	1399
[[:SENSe]:POWer[:RF]:PADJust:PRESelector?	1399
[[:SENSe]:POWer[:RF]:PCENter	1397
[[:SENSe]:POWer[:RF]:RANGe <real>	1657
[[:SENSe]:POWer[:RF]:RANGe?	1657
[[:SENSe]:POWer[:RF]:RANGe:AUTO ON OFF 1 0	1388
[[:SENSe]:POWer[:RF]:RANGe:AUTO?	1388
[[:SENSe]:POWer[:RF]:RANGe:OPTimize IMMEDIATE	1387
[[:SENSe]:POWer[:RF]:RANGe:OPTimize:ATTenuation OFF ELECTrical COMBined	1388
[[:SENSe]:POWer[:RF]:RANGe:OPTimize:ATTenuation?	1388
[[:SENSe]:PStatistic:SLTView[:STATe]?	619
[[:SENSe]:PStatistic:BANDwidth <freq>	583
[[:SENSe]:PStatistic:BANDwidth?	583
[[:SENSe]:PStatistic:COUNts <integer>	596
[[:SENSe]:PStatistic:COUNts?	596
[[:SENSe]:PStatistic:IF:GAIN:AUTO[:STATe] ON OFF 1 0	600
[[:SENSe]:PStatistic:IF:GAIN:AUTO[:STATe]?	600
[[:SENSe]:PStatistic:IF:GAIN[:STATe] ON OFF 1 0	600
[[:SENSe]:PStatistic:IF:GAIN[:STATe]?	600
[[:SENSe]:PStatistic:MEAS:OFFSet <time>	599

List of Commands

[[:SENSe]:PSTatistic:MEAS:OFFSet?	599
[[:SENSe]:PSTatistic:SLTView[:STATe] OFF ON 0 1	619
[[:SENSe]:PSTatistic:SWEEP:CYCLes <integer>	597
[[:SENSe]:PSTatistic:SWEEP:CYCLes?	597
[[:SENSe]:PSTatistic:SWEEP:TIME <time>	597
[[:SENSe]:PSTatistic:SWEEP:TIME <time>	598
[[:SENSe]:PSTatistic:SWEEP:TIME?	597
[[:SENSe]:PSTatistic:SWEEP:TIME?	598
[[:SENSe]:RADio:STANdard:BANDwidth B1M4 B3M B5M B10M B15M B20M	1554
[[:SENSe]:RADio:STANdard:BANDwidth?	1554
[[:SENSe]:RADio:STANdard:DIRection DLINK ULINK	1553
[[:SENSe]:RADio:STANdard:DIRection?	1553
[[:SENSe]:RADio:STANdard:PRESet B1M4 B3M B5M B10M B15M B20M	1556
[[:SENSe]:RECORDing:ABORt	1477
[[:SENSe]:RECORDing:INITiate[:IMMediate].	1477
[[:SENSe]:RECORDing:LENGth <real>,SECOnds RECOrds POINts	1478
[[:SENSe]:RECORDing:LENGth:STATe MAX MANual	1478
[[:SENSe]:RECORDing:LENGth:STATe?	1478
[[:SENSe]:RECORDing:LENGth:UNIT?	1478
[[:SENSe]:RECORDing:LENGth:VALue?	1478
[[:SENSe]:ROSCillator:BANDwidth WIDE NARRow	1493
[[:SENSe]:ROSCillator:BANDwidth?	1493
[[:SENSe]:ROSCillator:COUPLing NORMAl NACQuisition	1495
[[:SENSe]:ROSCillator:COUPLing?	1495
[[:SENSe]:ROSCillator:EXTernal:FREQuency <freq>	1492
[[:SENSe]:ROSCillator:EXTernal:FREQuency?	1492
[[:SENSe]:ROSCillator:SOURce INTernal EXTernal	1491
[[:SENSe]:ROSCillator:SOURce?	1491
[[:SENSe]:ROSCillator:SOURce:TYPE INTernal EXTernal SENSe	1490
[[:SENSe]:ROSCillator:SOURce:TYPE?	1490
[[:SENSe]:SEMAsk:AVERAge:COUNt <integer>	744

List of Commands

[[:SENSe]:SEMAsk:AVERage:COUNT?	744
[[:SENSe]:SEMAsk:AVERage[:STATe] ON OFF 1 0	744
[[:SENSe]:SEMAsk:AVERage[:STATe]?	744
[[:SENSe]:SEMAsk:BANDwidth[1] 2:INTEgration <bandwidth>	746
[[:SENSe]:SEMAsk:BANDwidth[1] 2:INTEgration?	746
[[:SENSe]:SEMAsk:BANDwidth[1] 2[:RESolution] <bandwidth>	750
[[:SENSe]:SEMAsk:BANDwidth[1] 2[:RESolution]?	750
[[:SENSe]:SEMAsk:BANDwidth[1] 2[:RESolution]:AUTO OFF ON 1 0	750
[[:SENSe]:SEMAsk:BANDwidth[1] 2[:RESolution]:AUTO?	750
[[:SENSe]:SEMAsk:BANDwidth[1] 2:VIDeo?	751
[[:SENSe]:SEMAsk:BANDwidth[1] 2:VIDeo:AUTO OFF ON 1 0	751
[[:SENSe]:SEMAsk:BANDwidth[1] 2:VIDeo:AUTO?	751
[[:SENSe]:SEMAsk:BANDwidth[1] 2:VIDeo:RATio <real>	753
[[:SENSe]:SEMAsk:BANDwidth[1] 2:VIDeo:RATio:AUTO OFF ON 1 0	753
[[:SENSe]:SEMAsk:BANDwidth[1] 2:VIDeo:RATio:AUTO?	753
[[:SENSe]:SEMAsk:BANDwidth[1] 2:VIDeo:RATio	753
[[:SENSe]:SEMAsk:BANDwidth:SHAPe ASENse GAUSSian FLATtop	732
[[:SENSe]:SEMAsk:BANDwidth:SHAPe?	732
[[:SENSe]:SEMAsk:CARRier:AUTO[:STATe] OFF ON 1 0	754
[[:SENSe]:SEMAsk:CARRier:AUTO[:STATe]?	754
[[:SENSe]:SEMAsk:CARRier:CPSD <real>	755
[[:SENSe]:SEMAsk:CARRier:CPSD?	755
[[:SENSe]:SEMAsk:CARRier:INDEX <integer>	757
[[:SENSe]:SEMAsk:CARRier:INDEX?	757
[[:SENSe]:SEMAsk:CARRier:PEAK[:POWer] <real>	756
[[:SENSe]:SEMAsk:CARRier:PEAK[:POWer]?	756
[[:SENSe]:SEMAsk:CARRier[:POWer] <real>	754
[[:SENSe]:SEMAsk:CARRier[:POWer]?	754
[[:SENSe]:SEMAsk:CARRier:PREFereNce:TYPE LRCarriers MPCarrier CINDEX MANual	757
[[:SENSe]:SEMAsk:CARRier:PREFereNce:TYPE?	757
[[:SENSe]:SEMAsk:DETEctor:CARRier:AUTO ON OFF 1 0	811

List of Commands

[:SENSe]:SEMAsk:DETEctor:CARRier:AUTO?	811
[:SENSe]:SEMAsk:DETEctor:CARRier[:FUNction] AVERAge NEGAtive NORMAl POSitive SAMPlE	810
[:SENSe]:SEMAsk:DETEctor:CARRier[:FUNction]?	810
[:SENSe]:SEMAsk:DETEctor:OFFSet:AUTO ON OFF 1 0	812
[:SENSe]:SEMAsk:DETEctor:OFFSet:AUTO?	812
[:SENSe]:SEMAsk:DETEctor:OFFSet[:FUNction] AVERAge NEGAtive NORMAl POSitive SAMPlE	812
[:SENSe]:SEMAsk:DETEctor:OFFSet[:FUNction]?	812
[:SENSe]:SEMAsk:FILTer[:RRC]:ALPHa <real>	784
[:SENSe]:SEMAsk:FILTer[:RRC]:ALPHa?	784
[:SENSe]:SEMAsk:FILTer[:RRC][:STATe] OFF ON 0 1	783
[:SENSe]:SEMAsk:FILTer[:RRC][:STATe]?	783
[:SENSe]:SEMAsk:FREQuency[1] 2:SPAN <freq>	747
[:SENSe]:SEMAsk:FREQuency[1] 2:SPAN?	747
[:SENSe]:SEMAsk:LIMits STD MAN	785
[:SENSe]:SEMAsk:LIMits?	785
[:SENSe]:SEMAsk:LIMits:TYPE MANUal JEITa ANONcriticalASUBcritical ACRitical TSB	788
[:SENSe]:SEMAsk:LIMits:TYPE MANUal NONCritical CRITical	785
[:SENSe]:SEMAsk:LIMits:TYPE?	785
[:SENSe]:SEMAsk:LIMits:TYPE?	788
[:SENSe]:SEMAsk:LIMits:TYPE:JEITA ASENse J30Mask J40Mask J50Mask	791
[:SENSe]:SEMAsk:LIMits:TYPE:JEITA?	791
[:SENSe]:SEMAsk:OFFSet[1] 2:LIST:BANDwidth:IMULti <integer>,	768
[:SENSe]:SEMAsk:OFFSet[1] 2:LIST:BANDwidth:IMULti?	768
[:SENSe]:SEMAsk:OFFSet[1] 2:LIST:BANDwidth[:RESolution] <bandwidth>,	766
[:SENSe]:SEMAsk:OFFSet[1] 2:LIST:BANDwidth[:RESolution]?	766
[:SENSe]:SEMAsk:OFFSet[1] 2:LIST:BANDwidth[:RESolution]:AUTO OFF ON 1 0,	766
[:SENSe]:SEMAsk:OFFSet[1] 2:LIST:BANDwidth[:RESolution]:AUTO?	766
[:SENSe]:SEMAsk:OFFSet[1] 2:LIST:BANDwidth:VIDeo <freq>,	769
[:SENSe]:SEMAsk:OFFSet[1] 2:LIST:BANDwidth:VIDeo?	769
[:SENSe]:SEMAsk:OFFSet[1] 2:LIST:BANDwidth:VIDeo:AUTO OFF ON 0 1,	769
[:SENSe]:SEMAsk:OFFSet[1] 2:LIST:BANDwidth:VIDeo:AUTO?	769

List of Commands

[[:SENSe]:SEMAsk:OFFSet[1] 2:LIST:BANDwidth:VIDeo:RATio <real>,	770
[[:SENSe]:SEMAsk:OFFSet[1] 2:LIST:BANDwidth:VIDeo:RATio?	770
[[:SENSe]:SEMAsk:OFFSet[1] 2:LIST:BANDwidth:VIDeo:RATio:AUTO OFF ON 0 1,	770
[[:SENSe]:SEMAsk:OFFSet[1] 2:LIST:BANDwidth:VIDeo:RATio:AUTO?	770
[[:SENSe]:SEMAsk:OFFSet[1] 2:LIST:FREQuency:STARt <freq>,	759
[[:SENSe]:SEMAsk:OFFSet[1] 2:LIST:FREQuency:STARt?	759
[[:SENSe]:SEMAsk:OFFSet[1] 2:LIST:FREQuency:STOP <freq>,	762
[[:SENSe]:SEMAsk:OFFSet[1] 2:LIST:FREQuency:STOP?	762
[[:SENSe]:SEMAsk:OFFSet[1] 2:LIST:SIDE BOTH NEGative POSitive,	765
[[:SENSe]:SEMAsk:OFFSet[1] 2:LIST:SIDE?	765
[[:SENSe]:SEMAsk:OFFSet[1] 2:LIST:STARt:ABSolute <real>,	772
[[:SENSe]:SEMAsk:OFFSet[1] 2:LIST:STARt:ABSolute?	772
[[:SENSe]:SEMAsk:OFFSet[1] 2:LIST:STARt:RCARrier <rel_ampl>,	777
[[:SENSe]:SEMAsk:OFFSet[1] 2:LIST:STARt:RCARrier?	777
[[:SENSe]:SEMAsk:OFFSet[1] 2:LIST:STATe ON OFF 1 0,	759
[[:SENSe]:SEMAsk:OFFSet[1] 2:LIST:STATe?	759
[[:SENSe]:SEMAsk:OFFSet[1] 2:LIST:STOP:ABSolute <real>,	774
[[:SENSe]:SEMAsk:OFFSet[1] 2:LIST:STOP:ABSolute?	774
[[:SENSe]:SEMAsk:OFFSet[1] 2:LIST:STOP:ABSolute:COUPle ON OFF 1 0,	774
[[:SENSe]:SEMAsk:OFFSet[1] 2:LIST:STOP:ABSolute:COUPle?	774
[[:SENSe]:SEMAsk:OFFSet[1] 2:LIST:STOP:RCARrier <rel_ampl>,	779
[[:SENSe]:SEMAsk:OFFSet[1] 2:LIST:STOP:RCARrier?	779
[[:SENSe]:SEMAsk:OFFSet[1] 2:LIST:STOP:RCARrier:COUPle ON OFF 1 0,	779
[[:SENSe]:SEMAsk:OFFSet[1] 2:LIST:STOP:RCARrier:COUPle?	779
[[:SENSe]:SEMAsk:OFFSet[1] 2:LIST:SWEep:TIME <time>,	764
[[:SENSe]:SEMAsk:OFFSet[1] 2:LIST:SWEep:TIME?	764
[[:SENSe]:SEMAsk:OFFSet[1] 2:LIST:SWEep:TIME:AUTO ON OFF 1 0,	764
[[:SENSe]:SEMAsk:OFFSet[1] 2:LIST:SWEep:TIME:AUTO?	764
[[:SENSe]:SEMAsk:OFFSet[1] 2:LIST:TEST ABSolute AND OR RELative,	782
[[:SENSe]:SEMAsk:OFFSet[1] 2:LIST:TEST?	782
[[:SENSe]:SEMAsk:OFFSet[1] 2:TYPE CTOC CTOE ETOC ETOE RTOC RTOE	798

List of Commands

[:SENSe]:SEMAsk:OFFSet[1]2:TYPE CTOCenter CTOEdge ETOCenter ETOEdge	794
[:SENSe]:SEMAsk:OFFSet[1]2:TYPE?	794
[:SENSe]:SEMAsk:OFFSet[1]2:TYPE?	798
[:SENSe]:SEMAsk:SWEep[1]2:TIME <time>	748
[:SENSe]:SEMAsk:SWEep[1]2:TIME?	748
[:SENSe]:SEMAsk:SWEep[1]2:TIME:AUTO OFF ON 1	748
[:SENSe]:SEMAsk:SWEep[1]2:TIME:AUTO?	748
[:SENSe]:SEMAsk:TYPE ?	745
[:SENSe]:SEMAsk:TYPE PSDRef TPRef SPRef	745
[:SENSe]:SIDentify:MODE ISUPpress ISHift	1448
[:SENSe]:SIDentify:MODE?	1448
[:SENSe]:SIDentify[:STATe] OFF ON 0 1	1447
[:SENSe]:SIDentify[:STATe]?	1447
[:SENSe]:SPECtrum NORMal INVert	1554
[:SENSe]:SPECtrum NORMal INVert	1703
[:SENSe]:SPECtrum?	1554
[:SENSe]:SPECtrum?	1703
[:SENSe]:SPURious:AVERage:COUNT <integer>	641
[:SENSe]:SPURious:AVERage:COUNT?	641
[:SENSe]:SPURious:AVERage[:STATe] ON OFF 1 0	641
[:SENSe]:SPURious:AVERage[:STATe]?	641
[:SENSe]:SPURious:AVERage:TCONtrol EXPonential REPeat	642
[:SENSe]:SPURious:AVERage:TCONtrol?	642
[:SENSe]:SPURious:CARRier:FREQuency:MS <freq>	673
[:SENSe]:SPURious:CARRier:FREQuency:MS?	673
[:SENSe]:SPURious:CARRier:FREQuency:STARt <freq>	671
[:SENSe]:SPURious:CARRier:FREQuency:STARt?	671
[:SENSe]:SPURious:CARRier:FREQuency:STOP <freq>	671
[:SENSe]:SPURious:CARRier:FREQuency:STOP?	671
[:SENSe]:SPURious:CARRier:POWer <real>	675
[:SENSe]:SPURious:CARRier:POWer?	675

List of Commands

<rel_ampl>, <rel_ampl>, <rel_ampl>, <rel_ampl>, <rel_ampl>, <rel_ampl>, <rel_ampl>.....	656
[[:SENSe]:SPURious[:RANGe][:LIST]:PEAK:EXCURsion?	656
[[:SENSe]:SPURious[:RANGe][:LIST]:PEAK:THReshold <real>, <real>, <real>, <real>, <real>, <real>, <real>, <real>, <real>, <real>, <real>, <real>, <real>, <real>, <real>, <real>, <real>	657
[[:SENSe]:SPURious[:RANGe][:LIST]:PEAK:THReshold?	657
[[:SENSe]:SPURious[:RANGe][:LIST]:STATe ON OFF 1 0, ON OFF 1 0, ON OFF 1 0, ON OFF 1 0, ON OFF 1 0, ON OFF 1 0, ON OFF 1 0, ON OFF 1 0, ON OFF 1 0, ON OFF 1 0, ON OFF 1 0, ON OFF 1 0, ON OFF 1 0, ON OFF 1 0, ON OFF 1 0, ON OFF 1 0	643
[[:SENSe]:SPURious[:RANGe][:LIST]:STATe?	643
[[:SENSe]:SPURious[:RANGe][:LIST]:SWEep:POINts <integer>.....	662
[[:SENSe]:SPURious[:RANGe][:LIST]:SWEep:POINts?	662
[[:SENSe]:SPURious[:RANGe][:LIST]:SWEep:POINts:AUTO OFF ON 0 1, OFF ON 0 1, OFF ON 0 1, OFF ON 0 1, OFF ON 0 1, OFF ON 0 1, OFF ON 0 1, OFF ON 0 1, OFF ON 0 1, OFF ON 0 1, OFF ON 0 1, OFF ON 0 1, OFF ON 0 1, OFF ON 0 1, OFF ON 0 1, OFF ON 0 1, OFF ON 0 1	662
[[:SENSe]:SPURious[:RANGe][:LIST]:SWEep:POINts:AUTO?	662
[[:SENSe]:SPURious[:RANGe][:LIST]:SWEep:TIME <time>, <time>, <time>, <time>, <time>, <time>, <time>, <time>, <time>, <time>, <time>, <time>, <time>, <time>, <time>, <time>, <time>	661
[[:SENSe]:SPURious[:RANGe][:LIST]:SWEep:TIME?	661
[[:SENSe]:SPURious[:RANGe][:LIST]:SWEep:TIME:AUTO OFF ON 0 1, OFF ON 0 1	661
[[:SENSe]:SPURious[:RANGe][:LIST]:SWEep:TIME:AUTO?	661
[[:SENSe]:SPURious:REPT:MODE ALL LIMTest	666
[[:SENSe]:SPURious:REPT:MODE?	666
[[:SENSe]:SPURious:SPUR <integer>.....	665
[[:SENSe]:SPURious:SPUR?	665
[[:SENSe]:SPURious:SWEep:TIME:AUTO:RULEs NORMAl ACCuracy	687
[[:SENSe]:SPURious:SWEep:TIME:AUTO:RULEs?	687
[[:SENSe]:SPURious:TDD:FREQuency:STARt <freq>.....	672
[[:SENSe]:SPURious:TDD:FREQuency:STARt?	672
[[:SENSe]:SPURious:TDD:FREQuency:STOP <freq>	673
[[:SENSe]:SPURious:TDD:FREQuency:STOP?	673
[[:SENSe]:SPURious:TYPE EXAMine FULL	665

List of Commands

[:SENSe]:SPURious:TYPE?	665
[:SENSe]:SWEep:EGATe:CONTRol EDGE LEVel	1588
[:SENSe]:SWEep:EGATe:CONTRol?	1588
[:SENSe]:SWEep:EGATe:DELay <time>.....	1584
[:SENSe]:SWEep:EGATe:DELay?	1584
[:SENSe]:SWEep:EGATe:DELay:COMPensation:TYPE OFF SETTled GDELay	1590
[:SENSe]:SWEep:EGATe:DELay:COMPensation:TYPE?	1590
[:SENSe]:SWEep:EGATe:EXTernal[1] 2:LEVel <voltage>	1592
[:SENSe]:SWEep:EGATe:EXTernal[1] 2:LEVel?	1592
[:SENSe]:SWEep:EGATe:HOLDoff <time>.....	1589
[:SENSe]:SWEep:EGATe:HOLDoff?	1589
[:SENSe]:SWEep:EGATe:HOLDoff:AUTO OFF ON 0 1	1589
[:SENSe]:SWEep:EGATe:HOLDoff:AUTO?	1589
[:SENSe]:SWEep:EGATe:LENGth <time>.....	1584
[:SENSe]:SWEep:EGATe:LENGth?	1584
[:SENSe]:SWEep:EGATe:METHod LO VIDeo FFT	1585
[:SENSe]:SWEep:EGATe:METHod?	1585
[:SENSe]:SWEep:EGATe:MINFast?	1591
[:SENSe]:SWEep:EGATe:POLarity NEGative POSitive	1592
[:SENSe]:SWEep:EGATe:POLarity?	1592
[:SENSe]:SWEep:EGATe:SOURce EXTernal1 EXTernal2 LINE FRAME RFBurst	1587
[:SENSe]:SWEep:EGATe:SOURce?	1587
[:SENSe]:SWEep:EGATe[:STATe] OFF ON 0 1	1578
[:SENSe]:SWEep:EGATe[:STATe]?	1578
[:SENSe]:SWEep:EGATe:TIME <time>.....	1583
[:SENSe]:SWEep:EGATe:TIME?	1583
[:SENSe]:SWEep:EGATe:VIEW ON OFF 1 0	1580
[:SENSe]:SWEep:EGATe:VIEW?	1580
[:SENSe]:SWEep:EGATe:VIEW:STARt <time>	1583
[:SENSe]:SWEep:EGATe:VIEW:STARt?	1583
[:SENSe]:SWEep:FFT:WIDTh <real>	1574

List of Commands

[[:SENSe]:SWEep:FFT:WIDTh?	1574
[[:SENSe]:SWEep:FFT:WIDTh:AUTO OFF ON 0 1	1575
[[:SENSe]:SWEep:FFT:WIDTh:AUTO?	1575
[[:SENSe]:SWEep:POINts <integer>	1593
[[:SENSe]:SWEep:POINts?	1593
[[:SENSe]:SWEep:TIME <time>	1565
[[:SENSe]:SWEep:TIME?	1565
[[:SENSe]:SWEep:TIME:AUTO OFF ON 0 1	1565
[[:SENSe]:SWEep:TIME:AUTO?	1565
[[:SENSe]:SWEep:TIME:AUTO:RULes NORMal ACCuracy SRESponse	1567
[[:SENSe]:SWEep:TIME:AUTO:RULes?	1567
[[:SENSe]:SWEep:TIME:AUTO:RULes:AUTO[:STATe] ON OFF 1 0	1568
[[:SENSe]:SWEep:TIME:AUTO:RULes:AUTO[:STATe]?	1568
[[:SENSe]:SWEep:TIME:GATE:LEVel HIGH LOW	1592
[[:SENSe]:SWEep:TIME:GATE:LEVel?	1592
[[:SENSe]:SWEep:TYPE FFT SWEep	1570
[[:SENSe]:SWEep:TYPE?	1570
[[:SENSe]:SWEep:TYPE:AUTO OFF ON 0 1	1571
[[:SENSe]:SWEep:TYPE:AUTO?	1571
[[:SENSe]:SWEep:TYPE:AUTO:RULes SPEed DRANge	1572
[[:SENSe]:SWEep:TYPE:AUTO:RULes?	1572
[[:SENSe]:SWEep:TYPE:AUTO:RULes:AUTO[:STATe] OFF ON 0 1	1573
[[:SENSe]:SWEep:TYPE:AUTO:RULes:AUTO[:STATe]?	1573
[[:SENSe]:SWEep:TZOom:POINts <integer>	1594
[[:SENSe]:SWEep:TZOom:POINts?	1594
[[:SENSe]:VECTor ADEMod:FREQuency:CENTer:TRACk OFF ON 0 1	1717
[[:SENSe]:VECTor ADEMod:FREQuency:CENTer:TRACk?	1717
[[:SENSe]:VOLTage POWER:IQ:MIRRored OFF ON 0 1	1393
[[:SENSe]:VOLTage POWER:IQ:MIRRored?	1393
[[:SENSe]:VOLTage:IQ[:I]:RANGe[:UPPer] <voltage>	1391
[[:SENSe]:VOLTage:IQ[:I]:RANGe[:UPPer]?	1391

List of Commands

[:SENSe]:VOLTage:IQ:Q:RANGe[:UPPer] <voltage>	1393
[:SENSe]:VOLTage:IQ:Q:RANGe[:UPPer]?	1393
[:SENSe]:VOLTage:IQ:RANGe:AUTO OFF ON 0 1	1391
[:SENSe]:VOLTage:IQ:RANGe:AUTO?	1391
[:SENSe]:WAVeform:ADC:DITHer:AUTO[:STATe] OFF ON 0 1	1315
[:SENSe]:WAVeform:ADC:DITHer:AUTO[:STATe]?	1315
[:SENSe]:WAVeform:ADC:DITHer[:STATe] OFF ON 0 1	1316
[:SENSe]:WAVeform:ADC:DITHer[:STATe]?	1316
[:SENSe]:WAVeform:APERture?	1311
[:SENSe]:WAVeform:AVERage:COUNt <integer>	1308
[:SENSe]:WAVeform:AVERage:COUNt?	1308
[:SENSe]:WAVeform:AVERage[:STATe] OFF ON 0 1	1308
[:SENSe]:WAVeform:AVERage[:STATe]?	1308
[:SENSe]:WAVeform:AVERage:TACount <integer>	1310
[:SENSe]:WAVeform:AVERage:TACount?	1310
[:SENSe]:WAVeform:AVERage:TCONtrol EXPonential REPeat	1309
[:SENSe]:WAVeform:AVERage:TCONtrol?	1309
[:SENSe]:WAVeform:AVERage:TYPE LOG MAXimum MINimum RMS SCALar	1309
[:SENSe]:WAVeform:AVERage:TYPE?	1309
[:SENSe]:WAVeform:BANDwidth[:RESolution]	1280
[:SENSe]:WAVeform:DIF:BANDwidth <freq>	1279
[:SENSe]:WAVeform:DIF:BANDwidth?	1279
[:SENSe]:WAVeform:DIF:FILTer:ALPHa <real>	1291
[:SENSe]:WAVeform:DIF:FILTer:ALPHa?	1291
[:SENSe]:WAVeform:DIF:FILTer:BANDwidth <freq>	1290
[:SENSe]:WAVeform:DIF:FILTer:BANDwidth?	1290
[:SENSe]:WAVeform:DIF:FILTer:BANDwidth:AUTO ON OFF 1 0	1290
[:SENSe]:WAVeform:DIF:FILTer:BANDwidth:AUTO?	1290
[:SENSe]:WAVeform:DIF:FILTer:TYPE GAUSSian FLATtop SNYQuist RSNYquist RCOSine RRCosine	1281
[:SENSe]:WAVeform:DIF:FILTer:TYPE GAUSSian FLATtop	1281
[:SENSe]:WAVeform:DIF:FILTer:TYPE?	1281

List of Commands

[[:SENSe]:WAVeform:DIF:FILTer:TYPE?	1281
[[:SENSe]:WAVeform:FREQuency:SYNThesis:AUTO[:STATe] OFF ON 0 1	1314
[[:SENSe]:WAVeform:FREQuency:SYNThesis:AUTO[:STATe]?	1314
[[:SENSe]:WAVeform:FREQuency:SYNThesis[:STATe] 1 2 3	1312
[[:SENSe]:WAVeform:FREQuency:SYNThesis[:STATe]?	1312
[[:SENSe]:WAVeform:IF:GAIN:AUTO[:STATe] ON OFF 1 0.	1317
[[:SENSe]:WAVeform:IF:GAIN:AUTO[:STATe]?	1317
[[:SENSe]:WAVeform:IF:GAIN:OFFSet <rel_ampl >	1319
[[:SENSe]:WAVeform:IF:GAIN:OFFSet?	1319
[[:SENSe]:WAVeform:IF:GAIN[:STATe] AUTOrange LOW HIGH	1318
[[:SENSe]:WAVeform:IF:GAIN[:STATe]?	1318
[[:SENSe]:WAVeform:SRATe <freq>	1311
[[:SENSe]:WAVeform:SRATe?	1311
[[:SENSe]:WAVeform:SWEEp:TIME <time>.	1312
[[:SENSe]:WAVeform:SWEEp:TIME?	1312
[[:SENSe]:WAVeform:WBIF:FILTer:BANDwidth <real>	1291
[[:SENSe]:WAVeform:WBIF:FILTer:BANDwidth?	1291
[[:SENSe]:WAVeform:WBIF:FILTer[:TYPE] GAUSSian NONE NYQuist RNYQuist RCOSine RRCosine	1282
[[:SENSe]:WAVeform:WBIF:FILTer[:TYPE]?	1282
Seq Hopping	1355
[[:SNSe]:SEMAsk:BANDwidth[1] 2:VIDeo <bandwidth>	751
*SRE <integer>	177
*SRE?	177
*STB?	178
:SYSTem:APPLIcation:CATalog[:NAME]?	1541
:SYSTem:APPLIcation:CATalog[:NAME]:COUNT?	1540
:SYSTem:APPLIcation:CATalog:OPTion? <model>.	1541
:SYSTem:APPLIcation:CATalog:REVision? <model>	1541
:SYSTem:APPLIcation[:CURRent][:NAME]?	1539
:SYSTem:APPLIcation[:CURRent]:OPTion?	1540
:SYSTem:APPLIcation[:CURRent]:REVision?	1539

List of Commands

:SYSTem:COMMunicate:GPIB[1][:SELF]:ADDRess <integer>	296
:SYSTem:COMMunicate:GPIB[1][:SELF]:ADDRess?	296
:SYSTem:COMMunicate:GPIB[1][:SELF]:CONTroller[:ENABle] ON OFF 0 1	297
:SYSTem:COMMunicate:GPIB[1][:SELF]:CONTroller[:ENABle]?	297
:SYSTem:COMMunicate:LAN:SCPI:SICL:ENABle OFF ON 0 1	299
:SYSTem:COMMunicate:LAN:SCPI:SICL:ENABle?	299
:SYSTem:COMMunicate:LAN:SCPI:SOCKet:CONTrol?	299
:SYSTem:COMMunicate:LAN:SCPI:SOCKet:ENABle OFF ON 0 1	298
:SYSTem:COMMunicate:LAN:SCPI:SOCKet:ENABle?	298
:SYSTem:COMMunicate:LAN:SCPI:TELNet:ENABle OFF ON 0 1	298
:SYSTem:COMMunicate:LAN:SCPI:TELNet:ENABle?	298
:SYSTem:COMMunicate:USB:CONNectiOn?	310
:SYSTem:COMMunicate:USB:PACKets?	311
:SYSTem:COMMunicate:USB:STATus?	310
:SYSTem:CONFigure[:SYSTem]?	230
:SYSTem:DATE “<year>,<month>,<day>”	295
:SYSTem:DATE?	295
:SYSTem:DEFault [ALL] ALIGn INPut MISC MODes PON	280
:SYSTem:ERRor[:NEXT]?	226
:SYSTem:ERRor:OVERload[:STATe] 0 1 OFF ON	228
:SYSTem:ERRor:VERBose OFF ON 0 1	227
:SYSTem:ERRor:VERBose?	227
:SYSTem:HELP:HEADers?	294
:SYSTem:HID?	287
:SYSTem:IDN <string>	309
:SYSTem:IDN?	309
:SYSTem:KLOCK OFF ON 0 1	294
:SYSTem:KLOCK?	294
:SYSTem:LKEY <“OptionInfo”>, <“LicenseInfo”>	286
:SYSTem:LKEY? <“OptionInfo”>	287
:SYSTem:LKEY:DELete <“OptionInfo”>,<“LicenseInfo”>	286

List of Commands

:SYSTem:LKEY:LIST?	286
:SYSTem:MRElAy:COUnT?	290
:SYSTem:OPTions?	293
SYSTem:PDOWn [NORMal FORCe]	293
:SYSTem:PON:APPLication:LLISt <string of INSTRument:SElect names>	241
:SYSTem:PON:APPLication:LLISt?	241
:SYSTem:PON:APPLication:VMEMory[:AVAIlable]?	242
:SYSTem:PON:APPLication:VMEMory:TOTal?	242
:SYSTem:PON:APPLication:VMEMory:USED?	242
:SYSTem:PON:APPLication:VMEMory:USED:NAME? <INSTRument:SElect name>	242
:SYSTem:PON:ETIME?	291
:SYSTem:PON:MODE SA BASIC ADEMOD NFIGURE PNOISE CDMA2K TDSCDMA VSA VSA89601 WCDMA WIMAXOFDMA	237
:SYSTem:PON:MODE?	237
:SYSTem:PON:TIME?	256
:SYSTem:PON:TYPE MODE USER LAST	235
:SYSTem:PON:TYPE?	235
:SYSTem:PRESet	186
:SYSTem:PRESet:TYPE FACTory MODE USER	189
:SYSTem:PRESet:TYPE?	189
:SYSTem:PRESet:USER	313
:SYSTem:PRESet:USER:ALL	314
:SYSTem:PRESet:USER:SAVE	314
:SYSTem:PRINt:THEMe TDColor TDMonochrome FCOLor FMONochrome	183
:SYSTem:PRINt:THEMe?	183
:SYSTem:PUP:PROCCess	240
:SYSTem:SECurity:USB:WPROtect[:ENABle] ON OFF 0 1	288
:SYSTem:SECurity:USB:WPROtect[:ENABle]?	288
:SYSTem:SHOW OFF ERRor SYSTem HARDware LXI HWStatistics ALIGnment SOFTware CAPPLication	225
:SYSTem:SHOW?	225
:SYSTem:TEMPerature:HEXTreme?	291

List of Commands

:SYSTem:TEMPerature:LEXTreme?	291
:SYSTem:TIME “<hour>,<minute>,<second>”	295
:SYSTem:TIME?	295
:SYSTem:VERSion?	295
:TRACe[1] 2 3:ACPower:DISPlay[:STATe] ON OFF 0 1	563
:TRACe[1] 2 3:ACPower:DISPlay[:STATe]?	563
:TRACe[1] 2 3:ACPower:TYPE WRITe AVERAge MAXHold MINHold	561
:TRACe[1] 2 3:ACPower:TYPE?	561
:TRACe[1] 2 3:ACPower:UPDate[:STATe] ON OFF 0 1	563
:TRACe[1] 2 3:ACPower:UPDate[:STATe]?	563
:TRACe[1] 2 3:MONitor:DISPlay[:STATe] ON OFF 0 1	1258
:TRACe[1] 2 3:MONitor:DISPlay[:STATe]?	1258
:TRACe[1] 2 3:MONitor:TYPE WRITe AVERAge MAXHold MINHold	1257
:TRACe[1] 2 3:MONitor:TYPE?	1257
:TRACe[1] 2 3:MONitor:UPDate[:STATe] ON OFF 0 1	1258
:TRACe[1] 2 3:MONitor:UPDate[:STATe]?	1258
:TRACe:CHPower:TYPE WRITe AVERAge MAXHold MINHold	376
:TRACe:CHPower:TYPE?	376
:TRACe:MONitor:CLEar [TRACE1] TRACE2 TRACE3	1260
:TRACe:MONitor:CLEar:ALL	1261
:TRACe:OBWidth:TYPE WRITe AVERAge MAXHold MINHold	446
:TRACe:OBWidth:TYPE?	446
:TRACe:SEMask:TYPE WRITe AVERAge MAXHold MINHold	809
:TRACe:SEMask:TYPE?	809
*TRG	178
:TRIGger:<meas>[:SEquence]:SOURce IMMEDIATE VIDeo EXTernal1	1772
:TRIGger:<meas>[:SEquence]:SOURce?	1772
:TRIGger:<measurement>[:SEquence]:IQ:SOURce EXTernal1 EXTernal2 IMMEDIATE IQMag IDEMod QDE-Mod IINPut QINPut AIQMag	1602
:TRIGger:<measurement>[:SEquence]:IQ:SOURce?	1602
:TRIGger:<measurement>[:SEquence]:RF:SOURce EXTernal1 EXTernal2 IMMEDIATE LINE FRAME RF-Burst VIDeo IF ALARm LAN TV	1601

List of Commands

:TRIGger:<measurement>[:SEQuence]:RF:SOURce?	1601
:TRIGger:<measurement>[:SEQuence]:SOURce EXTernal1 EXTernal2 IMMediate LINE FRAME RFBurst VID- eo IF ALARm LAN IQMag IDEMod QDEMod IINPut QINPut AIQMag TV	1596
:TRIGger:<measurement>[:SEQuence]:SOURce?	1596
:TRIGger TRIGger1 TRIGger2[:SEQuence]:OUTPut HSWP MEASuring MAIN GATE GTRigger OEV- en SPOint SSWeep SSETtled S1Marker S2Marker S3Marker S4Marker OFF	1496
:TRIGger TRIGger1 TRIGger2[:SEQuence]:OUTPut?	1496
:TRIGger TRIGger1 TRIGger2[:SEQuence]:OUTPut:POLarity POSitive NEGative	1497
:TRIGger TRIGger1 TRIGger2[:SEQuence]:OUTPut:POLarity?	1497
:TRIGger[:SEQuence]:AIQMag:BANDwidth <freq>	1643
:TRIGger[:SEQuence]:AIQMag:BANDwidth?	1643
:TRIGger[:SEQuence]:AIQMag:CENTer <freq>	1643
:TRIGger[:SEQuence]:AIQMag:CENTer?	1643
:TRIGger[:SEQuence]:AIQMag:DELay <time>	1642
:TRIGger[:SEQuence]:AIQMag:DELay?	1642
:TRIGger[:SEQuence]:AIQMag:DELay:STATe OFF ON 0 1	1642
:TRIGger[:SEQuence]:AIQMag:DELay:STATe?	1642
:TRIGger[:SEQuence]:AIQMag:LEVel <ampl >	1641
:TRIGger[:SEQuence]:AIQMag:LEVel?	1641
:TRIGger[:SEQuence]:AIQMag:SLOPe POSitive NEGative	1642
:TRIGger[:SEQuence]:AIQMag:SLOPe?	1642
:TRIGger[:SEQuence]:ATRigger <time>	1644
:TRIGger[:SEQuence]:ATRigger?	1644
:TRIGger[:SEQuence]:ATRigger:STATe OFF ON 0 1	1644
:TRIGger[:SEQuence]:ATRigger:STATe?	1644
:TRIGger[:SEQuence]:DELay <time>	1608
:TRIGger[:SEQuence]:DELay?	1608
:TRIGger[:SEQuence]:DELay:STATe OFF ON 0 1	1608
:TRIGger[:SEQuence]:DELay:STATe?	1608
:TRIGger[:SEQuence]:EXTernal1:DELay <time>	1612
:TRIGger[:SEQuence]:EXTernal1:DELay <time>	1777
:TRIGger[:SEQuence]:EXTernal1:DELay?	1612

List of Commands

:TRIGger[:SEQuence]:EXTernal1:DELay?	1777
:TRIGger[:SEQuence]:EXTernal1:DELay:STATe OFF ON 0 1	1612
:TRIGger[:SEQuence]:EXTernal1:DELay:STATe OFF ON 0 1	1777
:TRIGger[:SEQuence]:EXTernal1:DELay:STATe?	1612
:TRIGger[:SEQuence]:EXTernal1:DELay:STATe?	1777
:TRIGger[:SEQuence]:EXTernal1:HOLDoff <time>	1778
:TRIGger[:SEQuence]:EXTernal1:HOLDoff?	1778
:TRIGger[:SEQuence]:EXTernal1:HOLDoff:STATe OFF ON 0 1	1778
:TRIGger[:SEQuence]:EXTernal1:HOLDoff:STATe?	1778
:TRIGger[:SEQuence]:EXTernal1:HOLDoff:TYPE BELOw ABOVe	1779
:TRIGger[:SEQuence]:EXTernal1:HOLDoff:TYPE?	1779
:TRIGger[:SEQuence]:EXTernal1:LEVel <level>	1611
:TRIGger[:SEQuence]:EXTernal1:LEVel <voltage>	1776
:TRIGger[:SEQuence]:EXTernal1:LEVel?	1611
:TRIGger[:SEQuence]:EXTernal1:LEVel?	1776
:TRIGger[:SEQuence]:EXTernal1:SLOPe POSitive NEGative	1612
:TRIGger[:SEQuence]:EXTernal1:SLOPe POSitive NEGative	1777
:TRIGger[:SEQuence]:EXTernal1:SLOPe?	1612
:TRIGger[:SEQuence]:EXTernal1:SLOPe?	1777
:TRIGger[:SEQuence]:EXTernal2:DELay <time>	1615
:TRIGger[:SEQuence]:EXTernal2:DELay?	1615
:TRIGger[:SEQuence]:EXTernal2:DELay:STATe OFF ON 0 1	1615
:TRIGger[:SEQuence]:EXTernal2:DELay:STATe?	1615
:TRIGger[:SEQuence]:EXTernal2:LEVel	1614
:TRIGger[:SEQuence]:EXTernal2:LEVel?	1614
:TRIGger[:SEQuence]:EXTernal2:SLOPe POSitive NEGative	1614
:TRIGger[:SEQuence]:EXTernal2:SLOPe?	1614
:TRIGger[:SEQuence]:FRAMe:ADJust <time>	1623
:TRIGger[:SEQuence]:FRAMe:DELay <time>	1627
:TRIGger[:SEQuence]:FRAMe:DELay?	1627
:TRIGger[:SEQuence]:FRAMe:DELay:STATe OFF ON 0 1	1627

List of Commands

:TRIGger[:SEquence]:FRAMe:DELay:STATe?	1627
:TRIGger[:SEquence]:FRAMe:OFFSet <time>	1622
:TRIGger[:SEquence]:FRAMe:OFFSet?	1622
:TRIGger[:SEquence]:FRAMe:OFFSet:DISPlay:RESet	1624
:TRIGger[:SEquence]:FRAMe:PERiod <time>	1622
:TRIGger[:SEquence]:FRAMe:PERiod?	1622
:TRIGger[:SEquence]:FRAMe:SYNC EXTernal1 EXTernal2 RFBurst OFF	1625
:TRIGger[:SEquence]:FRAMe:SYNC?	1625
:TRIGger[:SEquence]:FRAMe:SYNC:HOLDoff <time>	1628
:TRIGger[:SEquence]:FRAMe:SYNC:HOLDoff?	1628
:TRIGger[:SEquence]:FRAMe:SYNC:HOLDoff:STATe OFF ON 0 1	1628
:TRIGger[:SEquence]:FRAMe:SYNC:HOLDoff:STATe?	1628
:TRIGger[:SEquence]:HOLDoff <time>	1645
:TRIGger[:SEquence]:HOLDoff?	1645
:TRIGger[:SEquence]:HOLDoff:STATe OFF ON 0 1	1645
:TRIGger[:SEquence]:HOLDoff:STATe?	1645
:TRIGger[:SEquence]:HOLDoff:TYPE NORMAl ABOVe BELow	1646
:TRIGger[:SEquence]:HOLDoff:TYPE?	1646
:TRIGger[:SEquence]:IDEMod:DELay <time>	1637
:TRIGger[:SEquence]:IDEMod:DELay?	1637
:TRIGger[:SEquence]:IDEMod:DELay:STATe OFF ON 0 1	1637
:TRIGger[:SEquence]:IDEMod:DELay:STATe?	1637
:TRIGger[:SEquence]:IDEMod:LEVel <voltage>	1636
:TRIGger[:SEquence]:IDEMod:LEVel?	1636
:TRIGger[:SEquence]:IDEMod:SLOPe POSitive NEGative	1636
:TRIGger[:SEquence]:IDEMod:SLOPe?	1636
:TRIGger[:SEquence]:IINPut:DELay <time>	1639
:TRIGger[:SEquence]:IINPut:DELay?	1639
:TRIGger[:SEquence]:IINPut:DELay:STATe OFF ON 0 1	1639
:TRIGger[:SEquence]:IINPut:DELay:STATe?	1639
:TRIGger[:SEquence]:IINPut:LEVel <voltage>	1639

List of Commands

:TRIGger[:SEQuence]:IINPut:LEVel?	1639
:TRIGger[:SEQuence]:IINPut:SLOPe POSitive NEGative	1639
:TRIGger[:SEQuence]:IINPut:SLOPe?	1639
:TRIGger[:SEQuence]:IQMag:DELAy <time>	1635
:TRIGger[:SEQuence]:IQMag:DELAy?	1635
:TRIGger[:SEQuence]:IQMag:DELAy:STATe OFF ON 0 1	1635
:TRIGger[:SEQuence]:IQMag:DELAy:STATe?	1635
:TRIGger[:SEQuence]:IQMag:LEVel <ampl >	1634
:TRIGger[:SEQuence]:IQMag:LEVel?	1634
:TRIGger[:SEQuence]:IQMag:SLOPe POSitive NEGative	1635
:TRIGger[:SEQuence]:IQMag:SLOPe?	1635
:TRIGger[:SEQuence]:LINE:DELAy <time>	1610
:TRIGger[:SEQuence]:LINE:DELAy?	1610
:TRIGger[:SEQuence]:LINE:DELAy:STATe OFF ON 0 1	1610
:TRIGger[:SEQuence]:LINE:DELAy:STATe?	1610
:TRIGger[:SEQuence]:LINE:SLOPe POSitive NEGative	1609
:TRIGger[:SEQuence]:LINE:SLOPe?	1609
:TRIGger[:SEQuence]:OFFSet <time>	1608
:TRIGger[:SEQuence]:OFFSet?	1608
:TRIGger[:SEQuence]:OFFSet:STATe OFF ON 0 1	1608
:TRIGger[:SEQuence]:OFFSet:STATe?	1608
:TRIGger[:SEQuence]:QDEMod:DELAy <time>	1638
:TRIGger[:SEQuence]:QDEMod:DELAy?	1638
:TRIGger[:SEQuence]:QDEMod:DELAy:STATe OFF ON 0 1	1638
:TRIGger[:SEQuence]:QDEMod:DELAy:STATe?	1638
:TRIGger[:SEQuence]:QDEMod:LEVel <voltage>	1637
:TRIGger[:SEQuence]:QDEMod:LEVel?	1637
:TRIGger[:SEQuence]:QDEMod:SLOPe POSitive NEGative	1638
:TRIGger[:SEQuence]:QDEMod:SLOPe?	1638
:TRIGger[:SEQuence]:QINPut:DELAy <time>	1641
:TRIGger[:SEQuence]:QINPut:DELAy?	1641

List of Commands

:TRIGger[:SEquence]:QINPut:DElay:STATe OFF ON 0 1	1641
:TRIGger[:SEquence]:QINPut:DElay:STATe?	1641
:TRIGger[:SEquence]:QINPut:LEVel <voltage>	1640
:TRIGger[:SEquence]:QINPut:LEVel?	1640
:TRIGger[:SEquence]:QINPut:SLOPe POSitive NEGative	1640
:TRIGger[:SEquence]:QINPut:SLOPe?	1640
:TRIGger[:SEquence]:RECORDing:BASEband:DElay <time>	1784
:TRIGger[:SEquence]:RECORDing:BASEband:DElay?	1784
:TRIGger[:SEquence]:RECORDing:BASEband:DElay:STATe OFF ON 0 1	1784
:TRIGger[:SEquence]:RECORDing:BASEband:DElay:STATe?	1784
:TRIGger[:SEquence]:RECORDing:BASEband:HOLDoff <time>	1785
:TRIGger[:SEquence]:RECORDing:BASEband:HOLDoff?	1785
:TRIGger[:SEquence]:RECORDing:BASEband:HOLDoff:TYPE BELow ABOVe	1785
:TRIGger[:SEquence]:RECORDing:BASEband:HOLDoff:TYPE?	1785
:TRIGger[:SEquence]:RECORDing:BASEband:LEVel <voltage>	1783
:TRIGger[:SEquence]:RECORDing:BASEband:LEVel?	1783
:TRIGger[:SEquence]:RECORDing:BASEband:SLOPe POSitive NEGative	1784
:TRIGger[:SEquence]:RECORDing:BASEband:SLOPe?	1784
:TRIGger[:SEquence]:RECORDing:VIDeo:DElay <time>	1781
:TRIGger[:SEquence]:RECORDing:VIDeo:DElay?	1781
:TRIGger[:SEquence]:RECORDing:VIDeo:DElay:STATe OFF ON 0 1	1781
:TRIGger[:SEquence]:RECORDing:VIDeo:DElay:STATe?	1781
:TRIGger[:SEquence]:RECORDing:VIDeo:HOLDoff <time>	1781
:TRIGger[:SEquence]:RECORDing:VIDeo:HOLDoff?	1781
:TRIGger[:SEquence]:RECORDing:VIDeo:HOLDoff:STATe OFF ON 0 1	1781
:TRIGger[:SEquence]:RECORDing:VIDeo:HOLDoff:STATe?	1781
:TRIGger[:SEquence]:RECORDing:VIDeo:HOLDoff:TYPE BELow ABOVe	1782
:TRIGger[:SEquence]:RECORDing:VIDeo:HOLDoff:TYPE?	1782
:TRIGger[:SEquence]:RECORDing:VIDeo:LEVel <voltage>	1780
:TRIGger[:SEquence]:RECORDing:VIDeo:LEVel?	1780
:TRIGger[:SEquence]:RECORDing:VIDeo:SLOPe POSitive NEGative	1780

List of Commands

:TRIGger[:SEQuence]:RECOrding:VIDeo:SLOPe?	1780
:TRIGger[:SEQuence]:RFBurst:DELAy <time>	1619
:TRIGger[:SEQuence]:RFBurst:DELAy?	1619
:TRIGger[:SEQuence]:RFBurst:DELAy:STATe OFF ON 0 1	1619
:TRIGger[:SEQuence]:RFBurst:DELAy:STATe?	1619
:TRIGger[:SEQuence]:RFBurst:LEVel:ABSolute <ampl>	1616
:TRIGger[:SEQuence]:RFBurst:LEVel:ABSolute?	1616
:TRIGger[:SEQuence]:RFBurst:LEVel:RELAtive <rel_ampl>	1618
:TRIGger[:SEQuence]:RFBurst:LEVel:RELAtive?	1618
:TRIGger[:SEQuence]:RFBurst:LEVel:TYPE ABSolute RELAtive	1617
:TRIGger[:SEQuence]:RFBurst:LEVel:TYPE?	1617
:TRIGger[:SEQuence]:RFBurst:SLOPe POSitive NEGAtive	1619
:TRIGger[:SEQuence]:RFBurst:SLOPe?	1619
:TRIGger[:SEQuence]:RLINe OFF ON 0 1	1771
:TRIGger[:SEQuence]:RLINe?	1771
:TRIGger[:SEQuence]:SLOPe POSitive NEGAtive	1607
:TRIGger[:SEQuence]:SLOPe?	1607
:TRIGger[:SEQuence]:TV:FMODE ENTire ODD EVEN	1630
:TRIGger[:SEQuence]:TV:FMODE?	1630
:TRIGger[:SEQuence]:TV:LINE <integer>	1629
:TRIGger[:SEQuence]:TV:LINE?	1629
:TRIGger[:SEQuence]:TV:STANdard MNTSc JNTSc NTSC443 MPAL BPAL NPAL CPAL PAL60 LSEC ..	1631
:TRIGger[:SEQuence]:TV:STANdard?	1631
:TRIGger[:SEQuence]:VIDeo:DELAy <time>	1607
:TRIGger[:SEQuence]:VIDeo:DELAy <time>	1774
:TRIGger[:SEQuence]:VIDeo:DELAy?	1607
:TRIGger[:SEQuence]:VIDeo:DELAy?	1774
:TRIGger[:SEQuence]:VIDeo:DELAy:STATe OFF ON 0 1	1607
:TRIGger[:SEQuence]:VIDeo:DELAy:STATe OFF ON 0 1	1774
:TRIGger[:SEQuence]:VIDeo:DELAy:STATe?	1607
:TRIGger[:SEQuence]:VIDeo:DELAy:STATe?	1774

List of Commands

:TRIGger[:SEquence]:VIDeo:HOLDoff <time>	1775
:TRIGger[:SEquence]:VIDeo:HOLDoff?	1775
:TRIGger[:SEquence]:VIDeo:HOLDoff:STATe OFF ON 0 1	1775
:TRIGger[:SEquence]:VIDeo:HOLDoff:STATe?	1775
:TRIGger[:SEquence]:VIDeo:HOLDoff:TYPE BELow ABOVe	1776
:TRIGger[:SEquence]:VIDeo:HOLDoff:TYPE?	1776
:TRIGger[:SEquence]:VIDeo:LEVel <ampl>	1606
:TRIGger[:SEquence]:VIDeo:LEVel <voltage>	1773
:TRIGger[:SEquence]:VIDeo:LEVel?	1606
:TRIGger[:SEquence]:VIDeo:LEVel?	1773
:TRIGger[:SEquence]:VIDeo:SLOPe POSitive NEGative	1607
:TRIGger[:SEquence]:VIDeo:SLOPe POSitive NEGative	1773
:TRIGger[:SEquence]:VIDeo:SLOPe?	1607
:TRIGger[:SEquence]:VIDeo:SLOPe?	1773
*TST?	178
:UNIT:ACPower:POWer:PSD DBMHZ DBMMHZ	536
:UNIT:ACPower:POWer:PSD?	536
:UNIT:CHPower:POWer:PSD DBMHZ DBMMHZ	358
:UNIT:CHPower:POWer:PSD?	358
:UNIT:POWer DBM DBMV DBMA V W A DBUV DBUA DBUVM DBUAM DBPT DBG	1399
:UNIT:POWer?	1399
User PUSCH RB Start	1354
*WAI	179

1 Using Help

The online Help system is "context-sensitive", which means that the information displayed when you invoke the Help system depends on the selected instrument Mode, Measurement and key.

TIP To view help for any front-panel key or menu key, press that key while this Help Window is open.

To scroll any page vertically, press the **Down Arrow** or **Up Arrow** front-panel keys. To locate these keys, see [“Front Panel Keys used by the Help System” on page 127](#).

Structure of Help

See [“How Help is Organized” on page 124](#).

Navigating Help

- If the instrument has an attached mouse, see [“Navigating Help with a Mouse” on page 130](#).
- If the instrument does not have an attached mouse, see [“Navigating Help Without a Mouse” on page 131](#).

For specific details of how to navigate to topics, see [“Finding a Topic” on page 135](#).

- You can also copy the Help files to a separate computer and view them there. For details, see [“Viewing Help Files on a separate Computer” on page 138](#).

Locating Other Documentation

See [“Other Help Resources” on page 140](#).

Key Path	Front-panel key
----------	-----------------

How Help is Organized

This topic includes:

- “Help Contents Listing” on page 124
- “Key Descriptions for Each Measurement” on page 125
- “Key Information for Softkeys” on page 125
- “Common Measurement Functions” on page 126

Help Contents Listing

The listing under the Contents tab in the Help Window includes a topic for each Front-panel key and each softkey, for each available measurement.

The Contents listing is split into several major sections, as shown below for the HTML Help version of the document. The structure of the PDF version is similar.



Help information is split between these sections as follows:

1. Using Help

This section.

2. Additional Documentation

Describes available documents for X Series Analyzers, with links to allow you to download or open the files.

3. About the Analyzer

Provides general information about the instrument.

4. About this Mode or Measurement Application

Provides an overview of the currently-selected Measurement Application

5. Programming the Analyzer

Provides an overview of available programming information. Includes a list of all SCPI commands for the currently-selected Measurement Application.

6. System Functions

This section contains information for the following front-panel keys, which are listed in alphabetical order: **File, Preset, Print, Quick Save, Recall, Save, System, User Preset.**

The functions of these keys do not vary between measurements: they operate the same way, irrespective of which instrument measurement you have selected.

The sections for **Recall** and **Save** contain only cross-references to the respective sections in “[Common Measurement Functions](#)” on page 126, and are included here for convenience.

7. Measurement Functions

See “[Key Descriptions for Each Measurement](#)” on page 125 below.

8. Common Measurement Functions

See “[Common Measurement Functions](#)” on page 126 below.

Key Descriptions for Each Measurement

The Contents section for each Measurement is sub-divided into topics for each front-panel key, in alphabetical order, as shown below.

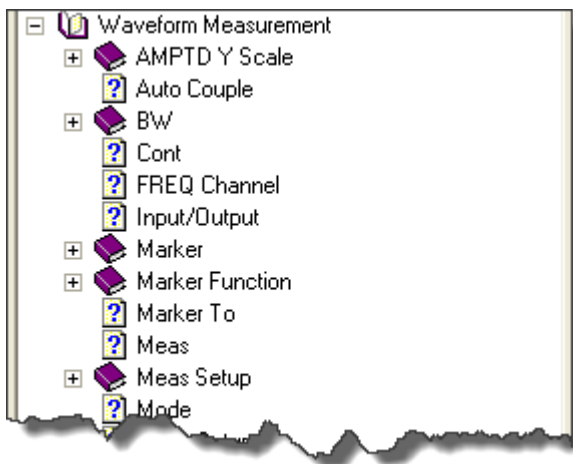

When you expand any front-panel key section, you will see a listing of softkeys in the menu for that front-panel key (if there is a menu), plus any SCPI Remote Commands associated with the functionality, as described in “[Key Information for Softkeys](#)” on page 125 below.

If you don't see a topic for a front-panel key in the Measurement-specific section, then it is located in the System Functions section.

Key Information for Softkeys

Information for each softkey that appears when you press a front-panel key (or a softkey with a submenu) is listed under the entry for each key.

The example below shows the submenu under the **SPAN X Scale** Front-panel key in the "Waveform"

Measurement, alongside the actual softkeys for that menu.

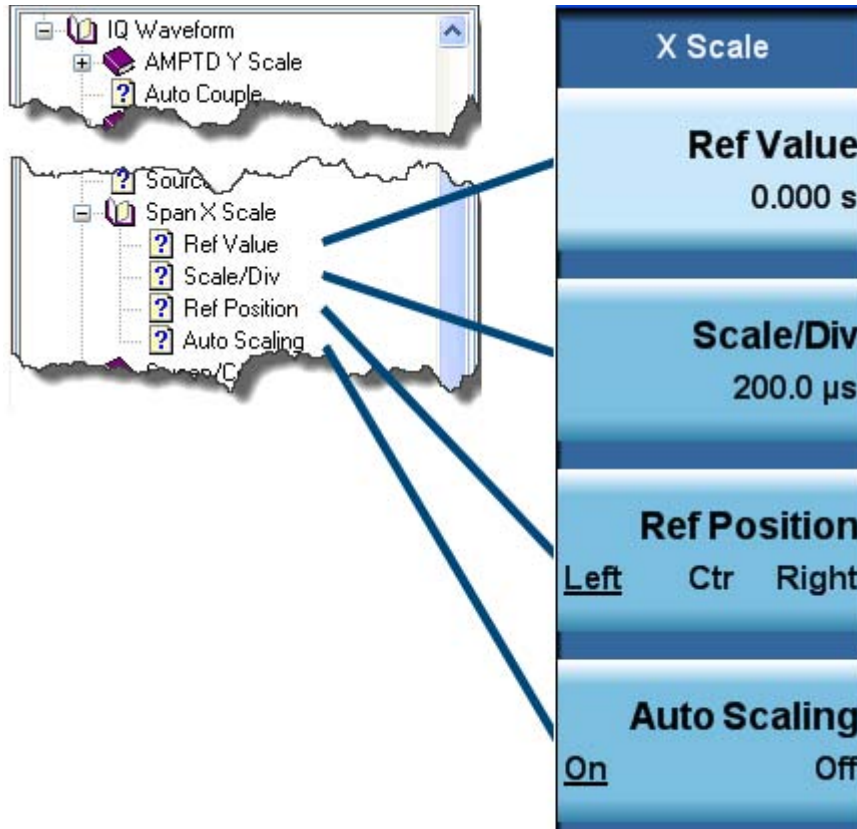

In these subsections, all softkeys are listed in the order they appear in their menu (that is, **not** in alphabetical order).

Common Measurement Functions

This section groups together function and key information that is shared between measurements. However, there is a listing for every front-panel key and subkey in the [Key Descriptions for Each Measurement](#), so you will generally not need to refer to this section.

The key subsections are listed alphabetically.

NOTE The presence of a key or command description in this section indicates that it is available in more than one measurement. Its presence does **not** indicate that the functionality is necessarily available in all measurements.

Front Panel Keys used by the Help System

The interactive Help system uses the front-panel keys shown below.



Item	Name	Description
1	Help	Opens Help (displaying the topic for the last key pressed).
2	Cancel (Esc)	Exits Help.
3	Next Window	Changes the current window pane selection.
4	Arrows / Enter	A central Enter key, surrounded by four directional arrow keys. Navigates within the Help system.
5	Backward Tab	Moves between controls in the Help display.
6	Forward Tab	Moves between controls in the Help display.
7	Select / Space	Navigates within the Help system, in conjunction with other keys.
8	Ctrl	Navigates within the Help system, in conjunction with other keys. See “Navigating the Help Files” on page 128.
9	Alt	Navigates within the Help system, in conjunction with other keys. See “Navigating the Help Files” on page 128.
10	Bk Sp (Backspace)	Acts as a "Back" key when navigating the pages of the Help system.

Navigating the Help Files

This topic includes:

- “Help Window Components” on page 128
- “Basic Help Window Operations” on page 129
- “Navigating Help with a Mouse” on page 130

Help Window Components

The Help Window appears on top of, and to the left of, the measurement display. When Help is open, the instrument’s display appears as below.



1. Application Title Bar

The instrument retains its current Mode and Measurement when Help is open, as shown in the Title Bar.

2. Help Button Bar

These buttons provide shortcuts to frequently-used help functions, including printing.

3. Help Navigation Pane Tabs

Click one of these tabs to display either the Table of Contents, Index, Search or Favorites controls.

4. Help Navigation Pane

5. Help Topic Pane

6. Previous Page and Next Page Buttons

Use these buttons to move to the previous or next page in the Help file.

7. Application Softkey Menu

You can still see and use the current softkey menu when Help is open.

When Help is open, pressing a softkey displays Help for that softkey, but does **not** execute the softkey’s function.

Basic Help Window Operations

This topic includes:

- [“Opening Help” on page 129](#)
- [“Getting Help for a Specific Key” on page 129](#)
- [“Closing Help” on page 129](#)
- [“Viewing Help on Using Help” on page 129](#)

For more Help window operations, see [“Navigating Help Without a Mouse” on page 131](#).

To locate the keys mentioned in this section, see [“Front Panel Keys used by the Help System” on page 127](#).

Opening Help

To access the Help system, press the green **Help** key below the front panel display while an Agilent application is running.



Note that the softkey menu remains visible when Help is open.

Getting Help for a Specific Key

- If Help is already open, press the desired key. The relevant Help topic appears.

The function normally invoked by the key is **not** executed when the key is pressed with Help open.

If you want to execute the key's function, first close Help by pressing the **Cancel (Esc)** key (as described in [“Closing Help” on page 129](#)), then press the key, before opening Help again (if required).

- If Help is **not** already open, press the desired key (which executes the key's function), then press the **Help** key to display the relevant Help page. Help is available for all softkeys, and for all the front-panel keys listed under the "System Functions" and "Measurement" sections.

For details of how to navigate within the panes of the Help window, see [“Navigating the Help Files” on page 128](#).

Closing Help

To close Help, and return to the measurement application, press the **Cancel (Esc)** key (depicted below).



Viewing Help on Using Help

With the Help window open, press the green **Help** key a second time.

Using Help

Navigating the Help Files

The "Using Help" page appears.

To exit Help on Using Help, press the **Bk Sp** key, or see [“Topic Pane Operations” on page 133](#) for equivalent methods.



Navigating Help with a Mouse

When Help is open, you can point-and-click to navigate, as you would when using Help for any Microsoft Windows computer application.

If you also have a keyboard attached to the instrument, you can use the Help system's full-text search feature to locate help for any topic, by typing in a key name, a topic name, or any other desired text. See [“Searching for a Help Topic” on page 131](#).

Selecting a Topic from the Contents Listing

To select and display a topic, do the following:

- If necessary, press the green **Help** key on the Front Panel, as described in [“Opening Help” on page 129](#), to open Help.
- Choose the desired topic from the list under the Contents Tab of the Navigation Pane, then click on the topic title to display the first page of the topic.
- To expand the tree and display a listing of subtopics (if any), click on the + icon to the left of the topic's book icon, as shown below.

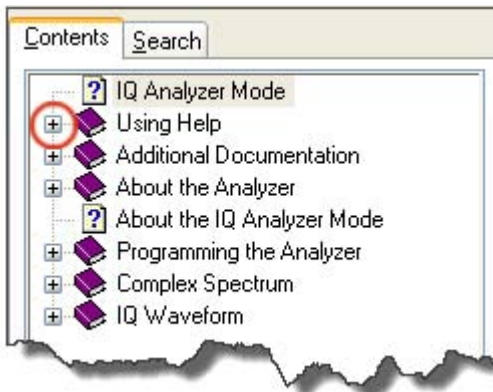

- To move to the next or previous page within a topic, click the **Next Page** or **Previous Page** keys (at the top right of the **Topic Pane**), as shown below.



Searching for a Help Topic

Select the "Search" tab of the Help Navigation Pane, then use the following procedure:

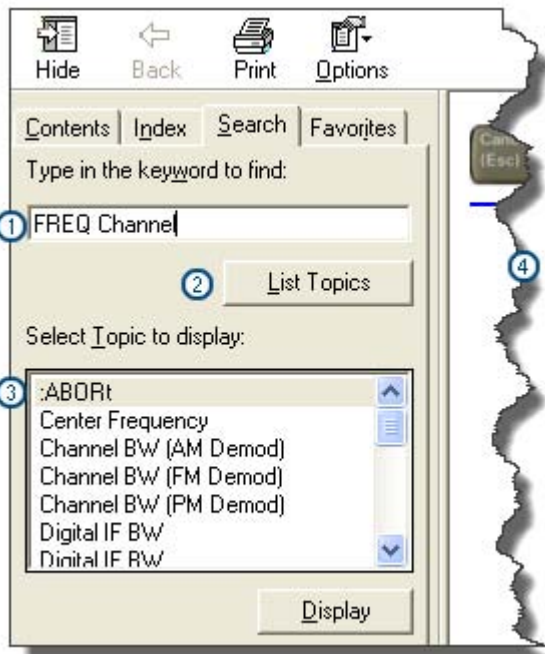

1. Type the desired topic text into the Search edit box. Note that the text search is **not** case-sensitive.
2. Click on the **List Topics** button.
3. **Either:**
 - Double-click on the desired topic in the list,
 - Or:**
 - Click on the desired topic to select it, then click the **Display** button beneath the list.
4. The topic is displayed in the Topic Pane.

Navigating Help Without a Mouse

Most features of the Help system can be accessed and navigated without attaching a mouse or keyboard to the instrument.

There are a few exceptions, as noted in [“Functions that cannot be used without a Mouse and Keyboard” on page 135](#).

This topic includes:

- [“Next Window Key” on page 132](#)
- [“Contents Tab \(Navigation Pane\) Operations” on page 132](#)
- [“Topic Pane Operations” on page 133](#)
- [“Selecting a Hyperlink” on page 134](#)

Using Help
Navigating the Help Files

- “Finding a Topic” on page 135

To locate all the keys mentioned in this section, see “Front Panel Keys used by the Help System” on page 127.

Next Window Key

- To toggle the focus between the Navigation Pane and the Topic Pane, press the **Next Window** key.



Contents Tab (Navigation Pane) Operations

- To switch the active tab, hold down the **Ctrl** key, then press either the **Forward Tab** or **Backward Tab** key.



- To scroll **horizontally**, hold down the **Ctrl** key, then press either the **Left Arrow** or **Right Arrow** keys.

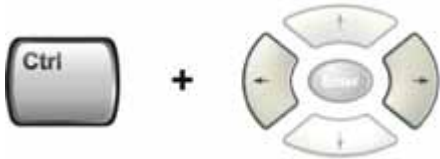

- To scroll **vertically**, hold down the **Ctrl** key, then press either the **Up Arrow** or **Down Arrow** keys.

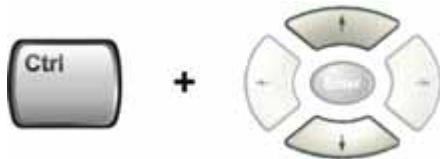

- To scroll up or down the list of topics, press the **Up Arrow** or **Down Arrow** keys.



- To display a selected topic in the Topic Pane, select it in the Contents listing, then press the **Enter** key.

key.



- To expand or collapse a selected topic, press the **Right Arrow** or **Left Arrow** key.



Topic Pane Operations

- To scroll up or down within a topic, press either the **Up Arrow** key or **Down Arrow** key.



- To go **back**
(that is, to display the previously-viewed topic), **either**:
Hold down the **Alt** key, then press the **Left Arrow** key.

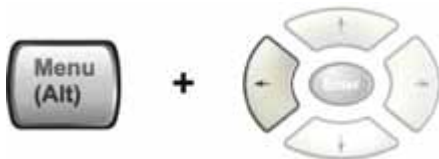

Or:

Press the **Bk Sp** key.



Using Help

Navigating the Help Files

- To go **forward**, hold down the **Alt** key, then press the **Right Arrow** key.

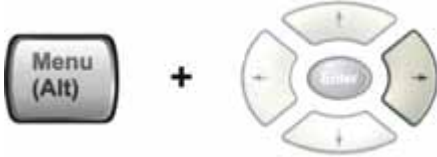

(The "Forward" operation has no effect unless there have been previous "Back" operations.)

- To go to the next or previous page, use the **Forward Tab** or **Backward Tab** keys



to select the **Next Page** or **Previous Page** key



then press **Enter**.



- To print the currently displayed, topic, press the Front-panel **Print** key



Selecting a Hyperlink

To select and follow a hyperlink on a Help page:.

1. Ensure that the focus is in the **Topic Pane**.

(If necessary, toggle the focus between the Navigation Pane and the Topic Pane by pressing the [Next Window Key](#).)

2. Move from link to link in the Topic Pane by pressing the **Forward Tab** and **Backward Tab** keys.



Links become highlighted upon selection.

3. When you have selected the desired link, activate it by pressing the **Enter** key.



Finding a Topic

To display a different Help topic by selecting it from the Contents tab of the Navigation Pane:

1. Ensure that the focus is in the Contents tab of the Navigation Pane.
(If necessary, toggle the focus between the Navigation Pane and the Topic Pane, by pressing the [Next Window Key](#). Then press **Ctrl + Forward Tab** or **Backward Tab** to select the Contents tab.)
2. Move up or down the Contents list, by pressing the **Up Arrow** or **Down Arrow** keys.

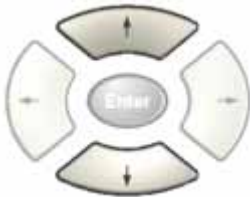

Topics become highlighted upon selection.

3. Display the selected topic, by pressing the **Enter** key.

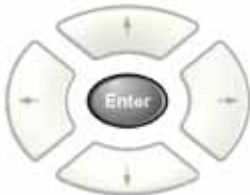

Functions that cannot be used without a Mouse and Keyboard

The following parts of the HTML Help System **cannot** easily be used without attaching a mouse and keyboard to the instrument.

- The buttons in the Help Button Bar, consisting of: **Hide**, **Back**, **Print** and **Options**.
- The functionality of the Search Tab of the Navigation Pane.
- The functionality of the Favorites Tab of the Navigation Pane.

Definition of Terms

Many special terms are used throughout this documentation. The table below provides brief definitions of commonly-used terms. Please refer to the "Getting Started Guide" for detailed explanations.

Term	Meaning
Default Unit	The default measurement unit of the setting.
Default Terminator	Indicates the units that will be attached to the numeric value that you have entered. This default will be used from the front panel, when you terminate your entry by pressing the Enter key, rather than selecting a units key. This default will be used remotely when you send the command without specifying any units after your value(s).
Dependencies/ Couplings	Some commands may be unavailable when other parameters are set in certain ways. If applicable, any such limitations are described here.
Example	Provides command examples using the indicated remote command syntax.
Factory Preset	Describes the function settings after a Factory Preset .
Key Path	The sequence of Front-panel keys that accesses the function or setting.
Knob Increment/Decrement	The numeric value of the minimum increment or decrement that is applied when turning the thumb wheel knob.
Max	The Maximum numerical value that the setting can take.
Min	The Minimum numerical value that the setting can take.
Meas Global	The functionality described is the same in all measurements.
Meas Local	The functionality described is only true for the measurement selected.
Mode Global	The functionality described is the same for all modes.
Preset	In some cases, a Preset operation changes the status of a parameter. If the operation of the key specified is modified by a Preset operation, the effect is described here.
Range	Describes the range of the smallest to largest values to which the function can be set. If you try to set a value below the minimum value, the instrument defaults to the minimum value. If you try to set a value above the maximum value, the instrument defaults to the maximum value.
Remote Command	Shows the syntax requirements for each SCPI command.
Remote Command Notes	Additional notes regarding Remote Commands.
Resolution	Specifies the smallest change that can be made to the numeric value of a parameter.
SCPI Status Bits/OPC Dependencies	Pressing certain keys may affect one or more status bits. If applicable, details are given here.

Term	Meaning
State Saved	Indicates what happens to a particular function when the instrument state is saved (either to an external memory device or the internal D: drive). It also indicates whether the current settings of the function are maintained if the instrument is powered on or preset using Power On Last State or User Preset .

Viewing Help Files on a separate Computer

You may want to view the help pages **without** having them appear on top of the instrument's screen.

Two separate Help files are available for each instrument Mode (or Measurement Application). The two files contain all the same help pages in different formats:

1. HTML Help (CHM) format.

These files are installed on the instrument's hard disk. To copy these files to another computer, see ["Copying the HTML Help \(CHM\) Files" on page 139](#) below.

2. Adobe Acrobat (PDF) format.

These files are called "Users & Programmers References". They are included on the Documentation CD supplied with the instrument, or may be downloaded from the Agilent web site.

For details of how to navigate PDF files, see ["Navigating Acrobat \(PDF\) Files" on page 140](#).

You can copy any of the CHM or PDF files to another computer, then open and view the help pages in the file on that computer.

Your choice of which file to copy and view may depend on what you want to do with the file (for example, whether you want to print it and read the paper copy, or view it on the computer).

The table below compares the relative advantages of the two formats:

Format Type	HTML Help Format (CHM Files)	Acrobat Format (PDF Files)
File Extension	CHM	PDF
Software Required to view file	Microsoft Windows operating system only, with Microsoft Internet Explorer installed.	Free Adobe Reader software can be downloaded for many operating systems, including: Microsoft Windows, Macintosh, Linux, Solaris.
Full Text Search?	Yes	Yes
Printable?	Yes, but with limited control.	Yes. Full print control. See "Printing Acrobat Files" on page 141 .
Printable Table of Contents?	No	Yes
Navigable without a Mouse and Keyboard?	Yes, but with some loss of functionality.	No
Has Page Numbers?	No	Yes
Context-Sensitive Display?	Yes, when viewed using the X-Series Analyzer application window.	No
Indexed?	Yes	No
Active Hyperlinks?	Yes	Yes

Copying the HTML Help (CHM) Files

You can find the HTML Help (.chm) files:

- **Either**, on the documentation CD that came with the instrument,
- **Or**, in a special directory on the instrument's hard disk. The directory path is:
C:\Program Files\Agilent\SignalAnalysis\Infrastructure\Help

NOTE You can open and view the HTML Help files only on a computer that has Microsoft Windows and Microsoft Internet Explorer installed.

Other Help Resources

- All available documentation is present either on the Documentation CD that was supplied with the instrument, or may be downloaded from the Agilent web site.
- Many of the supporting documents use the Adobe Acrobat (PDF) file format. You can view PDF files using the pre-installed Adobe Reader software.

The Adobe Reader user interface differs from the Windows Help interface. For full details, see [“Navigating Acrobat \(PDF\) Files” on page 140](#) and [“Printing Acrobat Files” on page 141](#).

Navigating Acrobat (PDF) Files

IMPORTANT To navigate PDF files effectively, you must attach a mouse and keyboard to the instrument. If it is not possible to attach a mouse and keyboard to the instrument, you should transfer the PDF file to a separate computer, then open it on that computer.

Acrobat Reader Window

When a PDF file is open and being viewed, the instrument’s display shows the Adobe Acrobat Reader Window, which has the following features.

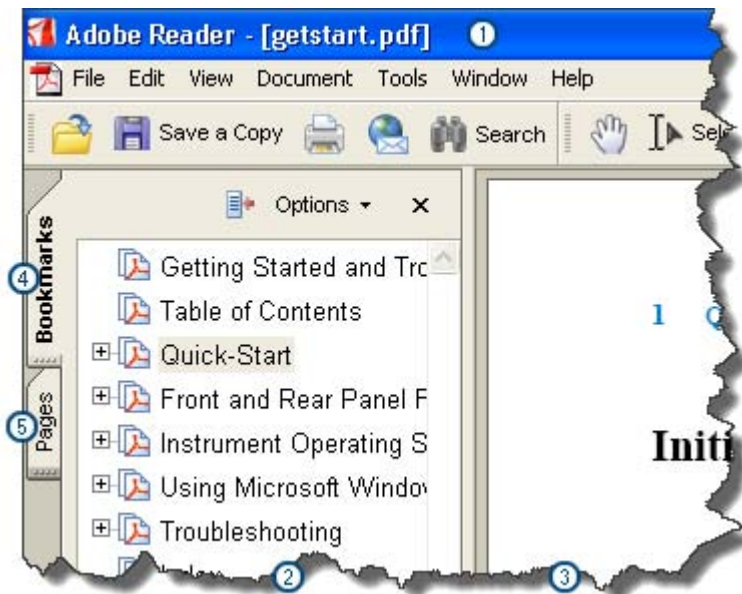

1. Adobe Acrobat Reader Window title bar
2. Navigation Pane
3. Document Pane
4. Navigation Pane: Bookmarks tab

5. Navigation Pane: Pages tab

The Navigation Pane also has tabs labeled Attachments and Comments, but, typically, PDF files for Agilent X-Series Analyzers contain useful content only under the Bookmarks and Pages Tabs.

Unlike the HTML Help Window, the Acrobat Reader Window is **not** embedded in the instrument's Application window, but can be resized, moved and closed independently of the Application window.

Printing Acrobat Files

NOTE The driver for the appropriate printer must be installed on the instrument's hard disk before any file can be printed. For driver installation instructions, see the printer manufacturer's documentation.

To print all or part of an open Acrobat file from the instrument, do the following.

1. **Either,**

- a. click on the **Print** icon in the Acrobat Reader toolbar,



- b. **or,** select **File > Print** from the menu.

2. The Acrobat Reader Print dialog opens.

3. Choose the desired options within the Print dialog, then click **OK** to print (or click **Cancel** to cancel printing).

NOTE Clicking the **Properties** button within the Print dialog opens a window containing controls that are specific to the printer model installed. Check the printer manufacturer's documentation for details of these capabilities.

X-Series Signal Analyzers

The X-Series signal analyzers measure and monitor complex RF and microwave signals. Analog baseband analysis is available on MXA. The analyzer integrates traditional spectrum measurements with advanced vector signal analysis to optimize speed, accuracy, and dynamic range. The analyzer has Windows XP FES[®] built in as an operating system, which expands the usability of the analyzer.

With a broad set of applications and demodulation capabilities, an intuitive user interface, outstanding connectivity and powerful one-button measurements, the analyzer is ideal for both R&D and manufacturing engineers working on cellular, emerging wireless communications, general purpose, aerospace and defense applications.

Installing Application Software

When you want to install a measurement application after your initial hardware purchase, you actually only need to license it. All of the available applications are loaded in your analyzer at the time of purchase.

So when you purchase an application, you will receive an entitlement certificate that is used to obtain a license key for that particular measurement application. Enter the license key that you obtain into the Signal Analyzer to activate the new measurement application. See below for more information.

For the latest information on Agilent Signal Analyzer measurement applications and upgrade kits, visit the following internet URL.

http://www.agilent.com/find/sa_upgrades

Viewing a License Key

Measurement personalities purchased with your instrument have been installed and activated at the factory before shipment. The instrument requires a unique **License Key** for every measurement application purchased. The license key is a hexadecimal string that is specific to your measurement application, instrument model number and serial number. It enables you to install, or reactivate that particular application.

Press **System, Show, System** to display which measurement applications are currently licensed in your analyzer.

Go to the following location to view the license keys for the installed measurement applications:

C:\Programing Files\Agilent\Licensing

NOTE	You may want to keep a copy of your license key in a secure location. You can print out a copy of the display showing the license numbers to do this. If you should lose your license key, call your nearest Agilent Technologies service or sales office for assistance.
-------------	---

Obtaining and Installing a License Key

If you purchase an additional application that requires installation, you will receive an “Entitlement Certificate” which may be redeemed for a license key for one instrument. Follow the instructions that accompany the certificate to obtain your license key.

Installing a license key for the selected application can be done automatically using a USB memory device. To do this, you would put the license file on the USB memory device at the root level. Follow the instructions that come with your software installation kit.

Installing a license key can also be done manually using the license management application in the instrument. It is found through the instrument front panel keys at **System, Licensing. . .**, or internally at C:\Programming Files\Agilent\Licensing.

NOTE You can also use these procedures to reinstall a license key that has been accidentally deleted, or lost due to a memory failure.

Missing and Old Measurement Application Software

All the software applications were loaded at the time of original instrument manufacture. It is a good idea to regularly update your software with the latest available version. This assures that you get any improvements and expanded functionality that is available.

Because the software was loaded at the initial purchase, there may be additional measurement applications that are now available. If the application you are interested in licensing is not available, you will need to do a software update. (Press **System, Show, System.**)

Check the Agilent internet website for the latest software versions available for downloading:

http://www.agilent.com/find/pxa_software
http://www.agilent.com/find/mxa_software
http://www.agilent.com/find/exa_software
http://www.agilent.com/find/cxa_software

You must load the updated software package into the analyzer from a USB drive, or directly from the internet. An automatic loading program is included with the files.

X-Series Options and Accessories

Advanced Measurement Application Software

For a current list of application software, go to the following URLs.

For PXA,

<http://www.agilent.com/find/pxa/options>

Select the **PXA N9030A, Options and Measurement Applications** link on the top of the page.

For MXA,

<http://www.agilent.com/find/mxa/options>

Select the **MXA N9020A, Options and Measurement Applications** link on the top of the page.

For EXA,

<http://www.agilent.com/find/exa/options>

Select the **EXA N9010A, Options and Measurement Applications** link on the top of the page.

For CXA,

<http://www.agilent.com/find/cxa/options>

Select the **CXA N9000A, Options and Measurement Applications** link on the top of the page.

Front-Panel Features

PXA, MXA, and EXA

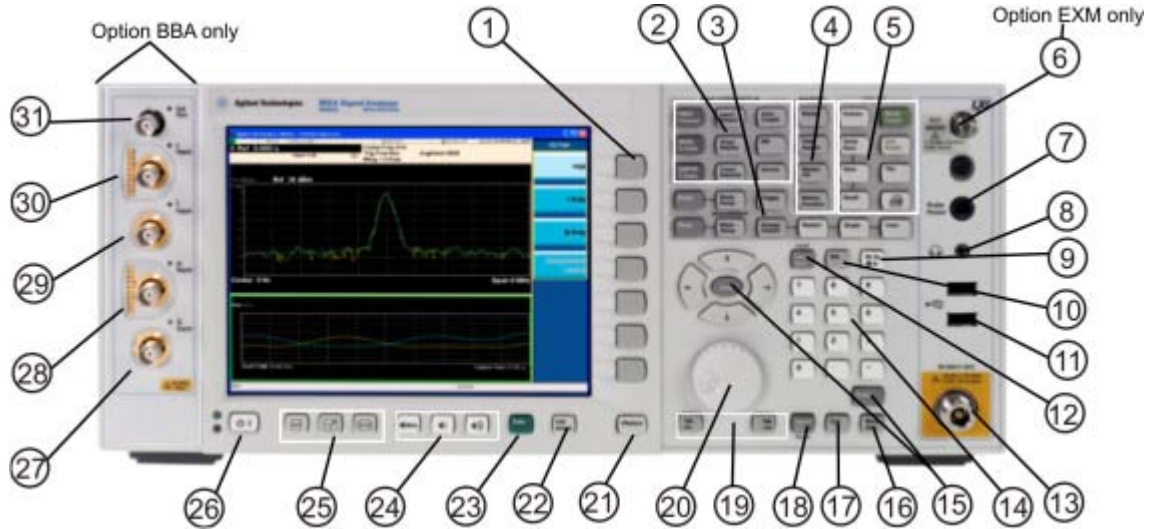

CXA

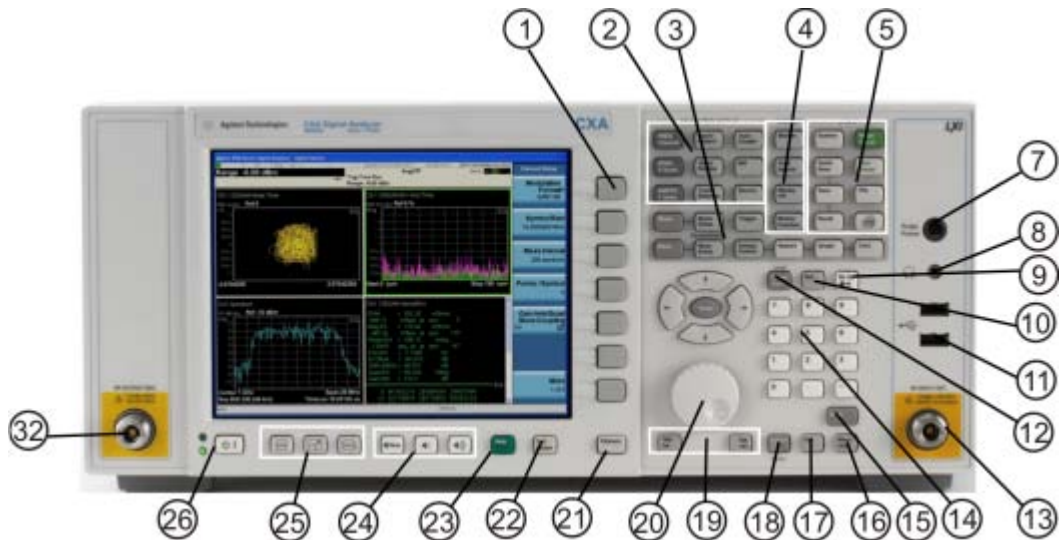

Item		Description
#	Name	
1	Menu Keys	Key labels appear to the left of the menu keys to identify the current function of each key. The displayed functions are dependent on the currently selected Mode and Measurement, and are directly related to the most recent key press.

About the Analyzer
Front-Panel Features

Item		Description
#	Name	
2	Analyzer Setup Keys	These keys set the parameters used for making measurements in the current Mode and Measurement.
3	Measurement Keys	These keys select the Mode and the Measurement within the mode. They also control the initiation and rate of recurrence of measurements.
4	Marker Keys	Markers are often available for a measurement to measure a very specific point/segment of data within the range of the current measurement data.
5	Utility Keys	These keys control system-wide functionality such as: <ul style="list-style-type: none"> • instrument configuration information and I/O setup, • printer setup and printing, • file management, save and recall, • instrument presets.
6	Ext Mixer	Provides LO output signal to and receives IF input signals from an external mixer. See the Specifications Guide for details on signal levels. PXA only.
7	Probe Power	Supplies power for external high frequency probes and accessories.
8	Headphones Output	Headphones can be used to hear any available audio output.
9	Back Space Key	Press this key to delete the previous character when entering alphanumeric information. It also works as the Back key in Help and Explorer windows.
10	Delete Key	Press this key to delete files or to perform other deletion tasks.
11	USB Connectors	Standard USB 2.0 ports, Type A. Connect to external peripherals such as a mouse, keyboard, DVD drive, or hard drive.
12	Local/Cancel/(Esc) Key	<p>If you are in remote operation, Local:</p> <ul style="list-style-type: none"> • returns instrument control from remote back to local (the front panel). • turns the display on (if it was turned off for remote operation). • can be used to clear errors. (Press the key once to return to local control, and a second time to clear error message line.) <p>If you have not already pressed the units or Enter key, Cancel exits the currently selected function without changing its value.</p> <p>Esc works the same as it does on a PC keyboard. It:</p> <ul style="list-style-type: none"> • exits Windows dialogs • clears errors • aborts printing • cancels operations.
13	RF Input	Connector for inputting an external signal. Make sure that the total power of all signals at the analyzer input does not exceed +30 dBm (1 watt).
14	Numeric Keypad	Enters a specific numeric value for the current function. Entries appear on the upper left of the display, in the measurement information area.

Item		Description
#	Name	
15	Enter and Arrow Keys	<p>The Enter key terminates data entry when either no unit of measure is needed, or you want to use the default unit.</p> <p>The arrow keys:</p> <ul style="list-style-type: none"> • Increment and decrement the value of the current measurement selection. • Navigate help topics. • Navigate or make selections within Windows dialogs. • Navigate within forms used for setting up measurements. • Navigate within tables. <p>NOTE The arrow keys cannot be used to move a mouse pointer around on the display.</p>
16	Menu/ (Alt) Key	Alt works the same as a PC keyboard. Use it to change control focus in Windows pull-down menus.
17	Ctrl Key	Ctrl works the same as a PC keyboard. Use it to navigate in Windows applications or to select multiple items in lists.
18	Select / Space Key	Select is also the Space key and it has typical PC functionality. For example, in Windows dialogs, it selects files, checks and unchecks check boxes, and picks radio button choices. It opens a highlighted Help topic.
19	Tab Keys	Use these keys to move between fields in Windows dialogs.
20	Knob	Increments and decrements the value of the current active function.
21	Return Key	Exits the current menu and returns to the previous menu. Has typical PC functionality.
22	Full Screen Key	Pressing this key turns off the softkeys to maximize the graticule display area. Press the key again to restore the normal display.
23	Help Key	Initiates a context-sensitive Help display for the current Mode. Once Help is accessed, pressing a front panel key brings up the help topic for that key function.
24	Speaker Control Keys	Enables you to increase or decrease the speaker volume, or mute it.
25	Window Control Keys	These keys select between single or multiple window displays. They zoom the current window to fill the data display, or change the currently selected window. They can be used to switch between the Help window navigation pane and the topic pane.
26	Power Standby/ On	<p>Turns the analyzer on. A green light indicates power on. A yellow light indicates standby mode.</p> <p>NOTE The front-panel switch is a standby switch, not a LINE switch (disconnecting device). The analyzer continues to draw power even when the line switch is in standby.</p> <p>The main power cord can be used as the system disconnecting device. It disconnects the mains circuits from the mains supply.</p>

About the Analyzer
Front-Panel Features

Item		Description
#	Name	
27	\bar{Q} Input	Input port for the \bar{Q} channel when in differential mode. ^a
28	Q Input	Input port for the Q channel for either single or differential mode. ^a
29	\bar{I} Input	Input port for the \bar{I} channel when in differential mode. ^a
30	I Input	Input port for the I channel for either single or differential mode. ^a
31	Cal Out	Output port for calibrating the I, \bar{I} , Q and \bar{Q} inputs and probes used with these inputs. ^a
32	RF Out	Output port for Options T03/07 (CXA only)

- a. Status of the LED indicates whether the current state of the port is active (green) or is not in use (dark).

Overview of key types

The keys labeled **FREQ Channel**, **System**, and **Marker Function** are all examples of front-panel keys.



Most of the dark or light gray keys access menus of functions that are displayed along the right side of the display. These displayed key labels are next to a column of keys called menu keys.

Menu keys list functions based on which front-panel key was pressed last. These functions are also dependant on the current selection of measurement application (**Mode**) and measurement (**Meas**).

If the numeric value of a menu key function can be changed, it is called an active function. The function label of the active function is highlighted after that key has been selected. For example, press **AMPTD Y Scale**. This calls up the menu of related amplitude functions. The function labeled **Ref Level** (the default selected key in the Amplitude menu) is highlighted. **Ref Level** also appears in the upper left of the display in the measurement information area. The displayed value indicates that the function is selected and its value can now be changed using any of the data entry controls.

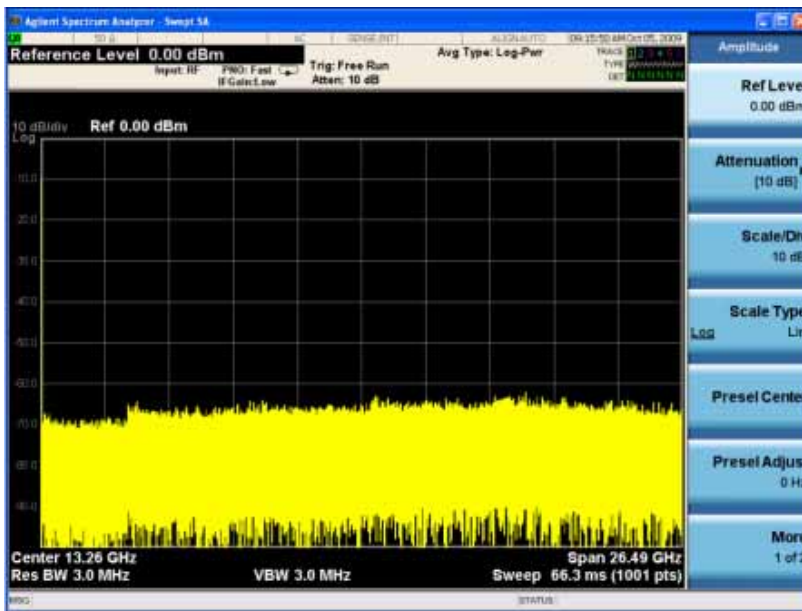

Some menu keys have multiple choices on their label, such as **On/Off**, **Auto/Man**, or **Log/Lin** (as shown above). The different choices are selected by pressing the key multiple times. For example, the Auto/Man type of key. To select the function, press the menu key and notice that Auto is underlined and the key becomes highlighted. To change the function to manual, press the key again so that Man is underlined. If there are more than two settings on the key, keep pressing it until the desired selection is underlined.

About the Analyzer Front-Panel Features

When a menu first appears, one key label is highlighted to show which key is the default selection. If you press **Marker Function**, the **Marker Function Off** key is the menu default key, and is highlighted.

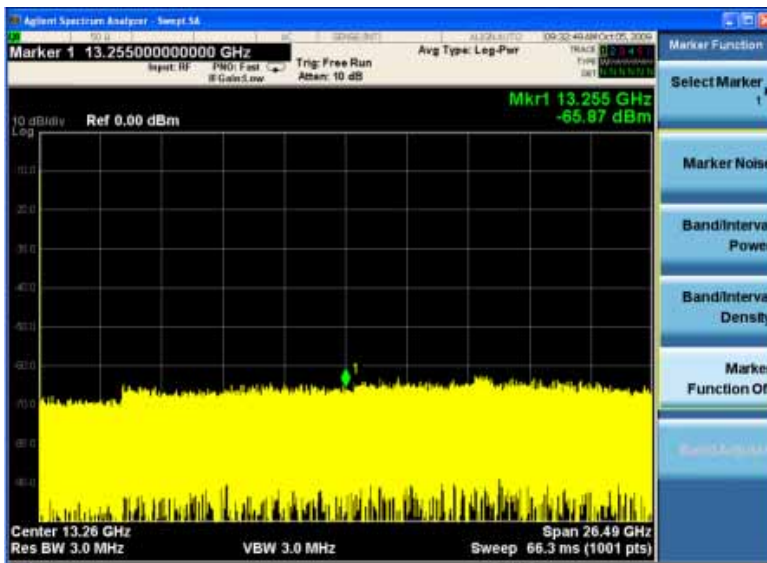

Some of the menu keys are grouped together by a yellow bar running behind the keys near the left side or by a yellow border around the group of keys. When you press a key within the yellow region, such as **Marker Noise**, the highlight moves to that key to show it has been selected. The keys that are linked are related functions and only one of them can be selected at any one time. For example, a marker can only have one marker function active on it. So if you select a different function it turns off the previous selection. If the current menu is two pages long, the yellow bar or border could include keys on the second page of keys.

In some key menus, a key label is highlighted to show which key has been selected from multiple available choices. And the menu is immediately exited when you press one of the other keys. For example, when you press the **Select Trace** key (in the **Trace/Detector** menu), it brings up its own menu of keys. The **Trace 1** key is highlighted. When you press the **Trace 2** key, the highlight moves to that key and the screen returns to the **Trace/Detector** menu.

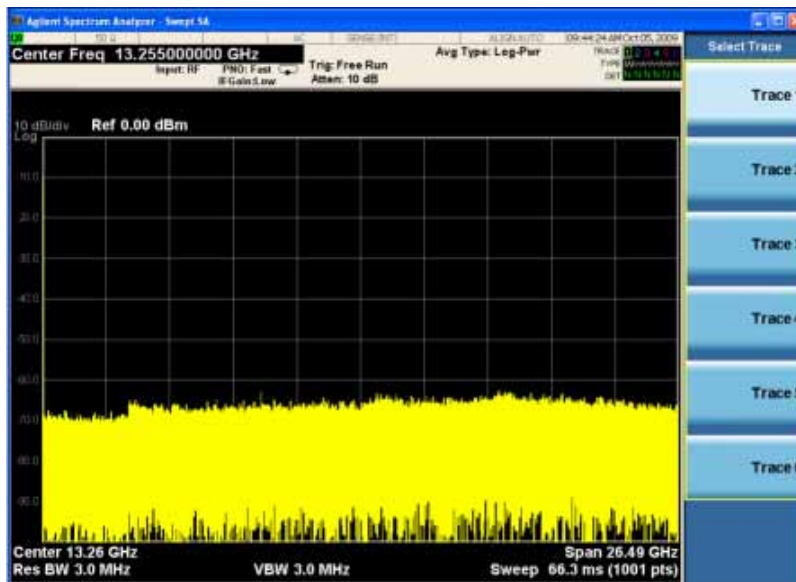

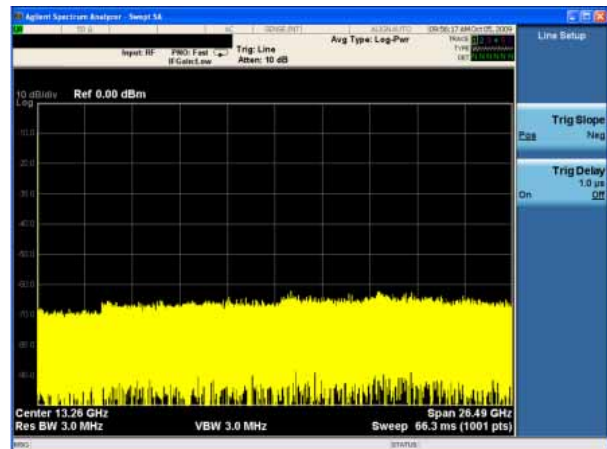
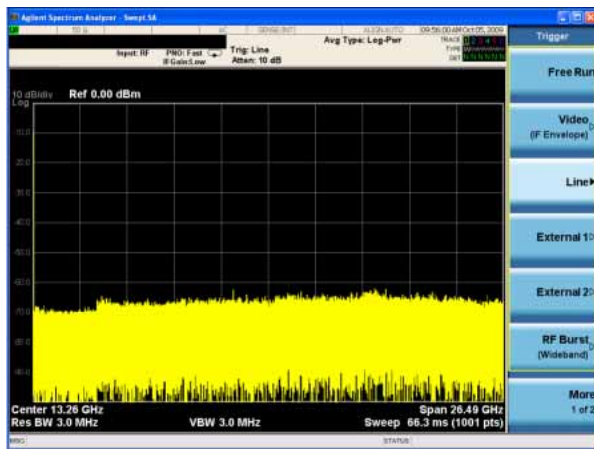
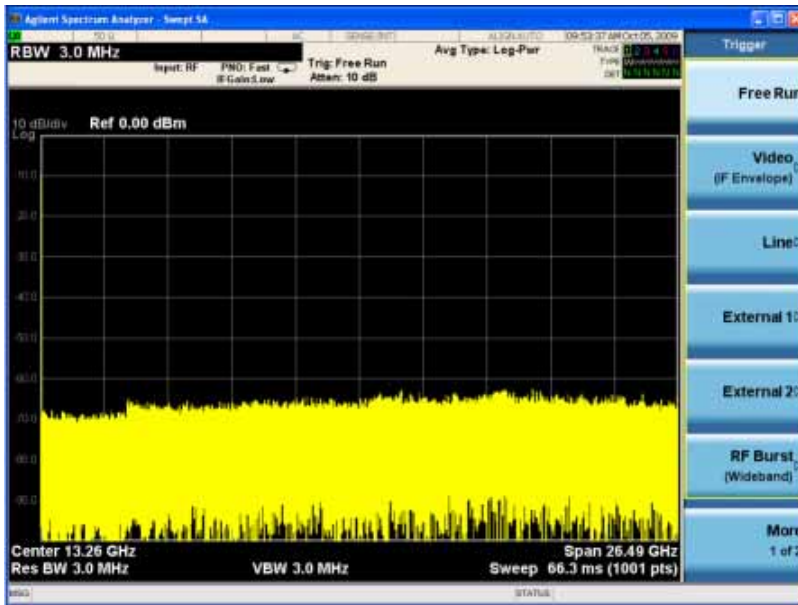

If a displayed key label shows a small solid-black arrow tip pointing to the right, it indicates that additional key menus are available. If the arrow tip is not filled in solid then pressing the key the first time selects that function. Now the arrow is solid and pressing it again brings up an additional menu of settings.

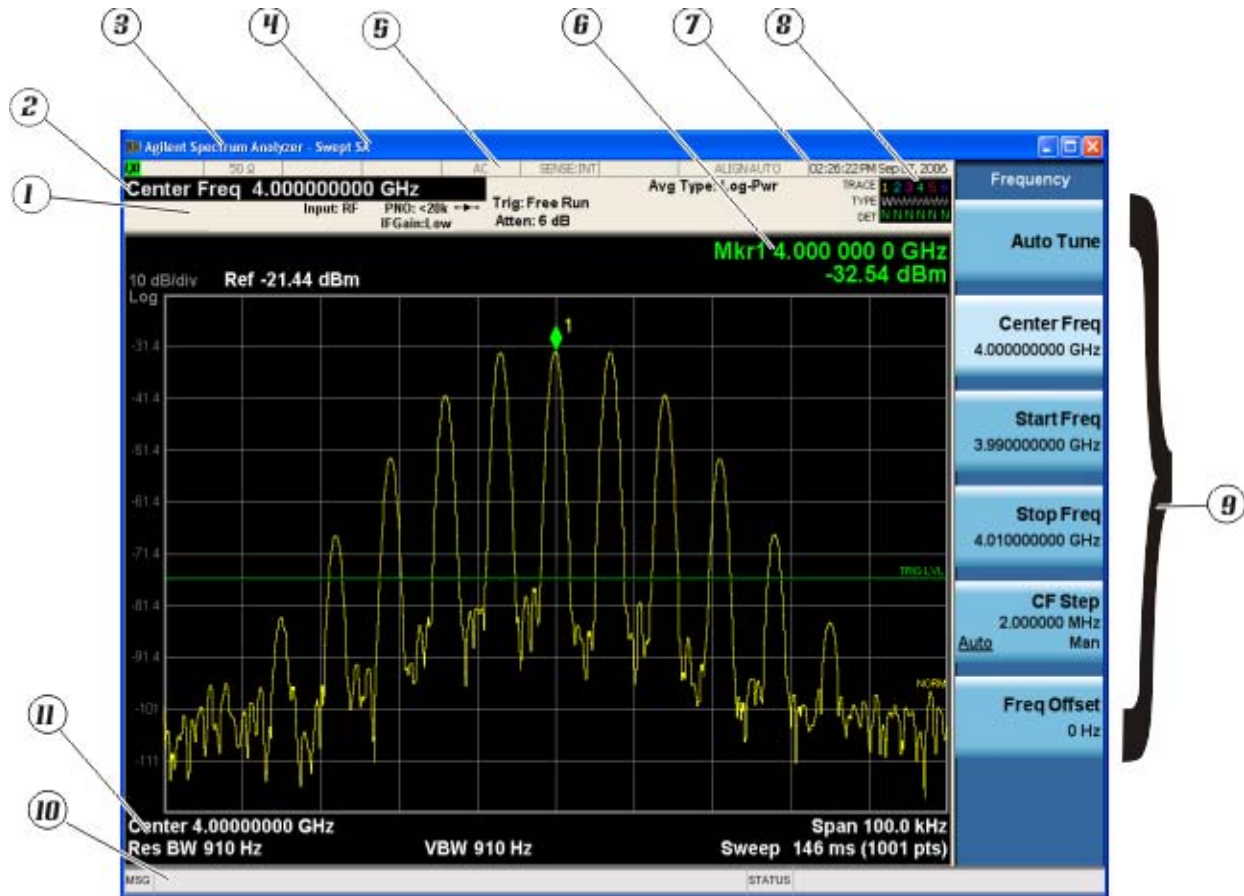

Display Annotations

This section describes the display annotation as it is on the Spectrum Analyzer Measurement Application display. Other measurement application modes have some annotation differences.



Item	Description	Function Keys
1	Measurement bar - Shows general measurement settings and information.  Indicates single/continuous measurement. Some measurements include limits that the data is tested against. A Pass/Fail indication may be shown in the lower left of the measurement bar.	All the keys in the Analyzer Setup part of the front panel.
2	Active Function (measurement bar) - when the current active function has a settable numeric value, it is shown here.	Currently selected front panel key.
3	Banner - shows the name of the selected application that is currently running.	Mode
4	Measurement title - shows title information for the current measurement, or a title that you created for the measurement.	Meas View/Display, Display, Title

Item	Description	Function Keys
5	Settings panel - displays system information that is not specific to any one application. <ul style="list-style-type: none"> • Input/Output status - green LXI indicates the LAN is connected. RLTS indicate Remote, Listen, Talk, SRQ • Input impedance and coupling • Selection of external frequency reference • Setting of automatic internal alignment routine 	Local and System, I/O Config Input/Output, Amplitude, System and others
6	Active marker frequency, amplitude or function value	Marker
7	Settings panel - time and date display.	System, Control Panel
8	Trace and detector information	Trace/Detector, Clear Write (W) Trace Average (A) Max Hold (M) Min Hold (m) Trace/Detector, More, Detector, Average (A) Normal (N) Peak (P) Sample (S) Negative Peak (p)
9	Key labels that change based on the most recent key press.	Softkeys
10	Displays information, warning and error messages. Message area - single events, Status area - conditions	
11	Measurement settings for the data currently being displayed in the graticule area. In the example above: center frequency, resolution bandwidth, video bandwidth, frequency span, sweep time and number of sweep points.	Keys in the Analyzer Setup part of the front panel.

Rear-Panel Features

Current PXA, MXA and EXA



Older MXA and EXA

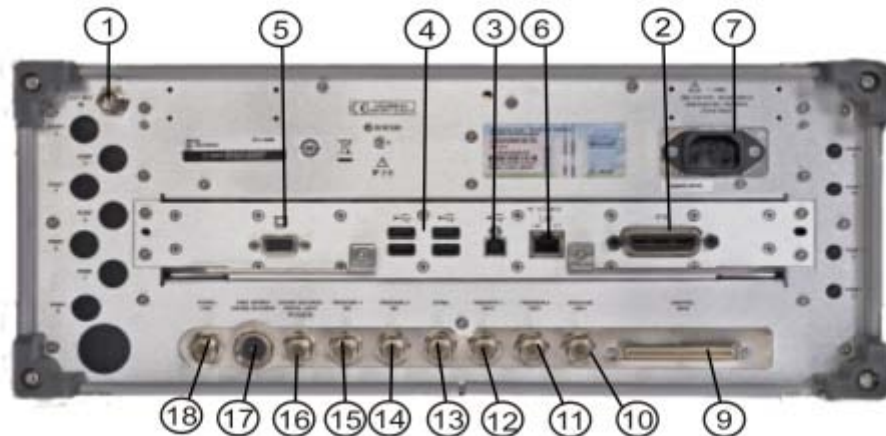

Item		Description
#	Name	
1	EXT REF IN	Input for an external frequency reference signal: For PXA – 1 to 50 MHz For MXA – 1 to 50 MHz For EXA – 10 MHz.
2	GPIB	A General Purpose Interface Bus (GPIB, IEEE 488.1) connection that can be used for remote analyzer operation.

Item		Description
#	Name	
3	USB Connector	USB 2.0 port, Type B. USB TMC (test and measurement class) connects to an external pc controller to control the instrument and for data transfers over a 480 Mbps link.
4	USB Connectors	Standard USB 2.0 ports, Type A. Connect to external peripherals such as a mouse, keyboard, printer, DVD drive, or hard drive.
5	MONITOR	Allows connection of an external VGA monitor.
6	LAN	A TCP/IP Interface that is used for remote analyzer operation.
7	Line power input	The AC power connection. See the product specifications for more details.
8	Removable Disk Drive	Standard on current analyzers. Optional on older MXAs and EXAs.
9	Digital Bus	Reserved for future use.
10	Analog Out	For PXA Option YAV: Screen Video Log Video Linear Video For Option EMC: Demod Audio
11	TRIGGER 2 OUT	A trigger output used to synchronize other test equipment with the analyzer. Configurable from the Input/Output keys.
12	TRIGGER 1 OUT	A trigger output used to synchronize other test equipment with the analyzer. Configurable from the Input/Output keys.
13	Sync	Reserved for future use.
14	TRIGGER 2 IN	Allows external triggering of measurements.
15	TRIGGER 1 IN	Allows external triggering of measurements.
16	Noise Source Drive +28 V (Pulsed)	For use with Agilent 346A, 346B, and 346C Noise Sources.
17	SNS Series Noise Source	For use with Agilent N4000A, N4001A, N4002A Smart Noise Sources (SNS).
18	10 MHz OUT	An output of the analyzer internal 10 MHz frequency reference signal. It is used to lock the frequency reference of other test equipment to the analyzer.
19	Preselector Tune Out	Reserved for future use.
20	Aux IF Out	CR3 Second IF Out (PXA, MXA, and EXA) CRP Arbitrary IF Out (PXA, MXA, and EXA) ALV Log Video (PXA)

CXA with Option PC3 (S/N MY/US/SG49370546 or higher)

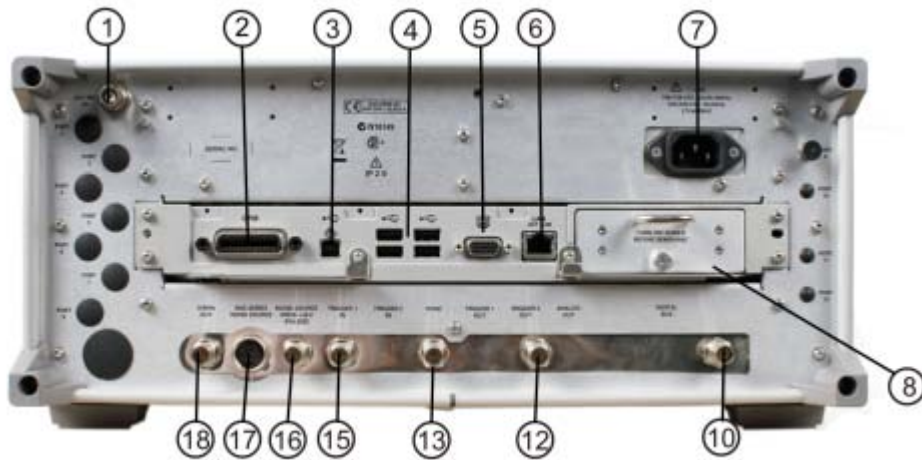

CXA (for S/N less than MY/US/SG49370546)

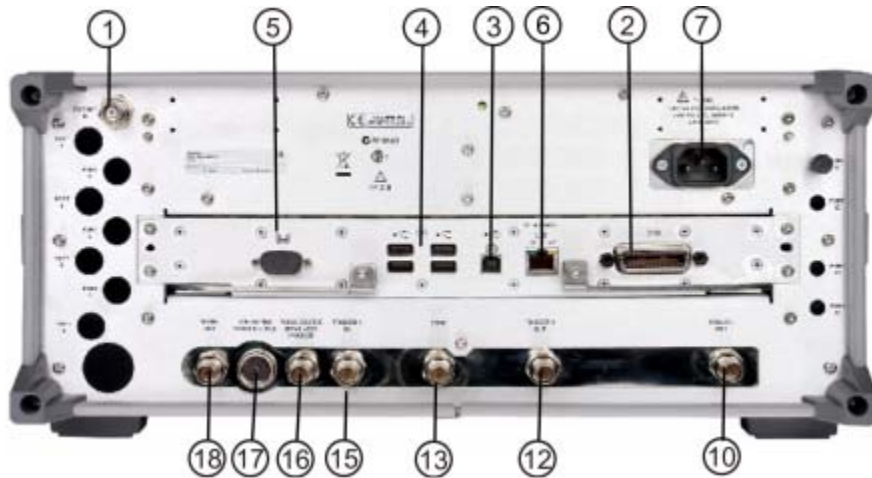

Item		Description
#	Name	
1	EXT REF IN	Input for an external frequency reference signal: For CXA – 10 MHz.
2	GPIB	A General Purpose Interface Bus (GPIB, IEEE 488.1) connection that can be used for remote analyzer operation.

Item		Description
#	Name	
3	USB Connector	USB 2.0 port, Type B. USB TMC (test and measurement class) connects to an external pc controller to control the instrument and for data transfers over a 480 Mbps link.
4	USB Connectors	Standard USB 2.0 ports, Type A. Connect to external peripherals such as a mouse, keyboard, printer, DVD drive, or hard drive.
5	MONITOR	Allows connection of an external VGA monitor.
6	LAN	A TCP/IP Interface that is used for remote analyzer operation.
7	Line power input	The AC power connection. See the product specifications for more details.
8	Removable Disk Drive	Option PC3. Only available on instruments with S/N MY/US/SG49370546 or higher.
10	Analog Out	For Option EMC: Demod Audio
12	TRIGGER 1 OUT	A trigger output used to synchronize other test equipment with the analyzer. Configurable from the Input/Output keys.
13	Sync	Reserved for future use.
15	TRIGGER 1 IN	Allows external triggering of measurements.
16	Noise Source Drive +28 V (Pulsed)	For use with Agilent 346A, 346B, and 346C Noise Sources.
17	SNS Series Noise Source	For use with Agilent N4000A, N4001A, N4002A Smart Noise Sources (SNS).
18	10 MHz OUT	An output of the analyzer internal 10 MHz frequency reference signal. It is used to lock the frequency reference of other test equipment to the analyzer.

Window Control Keys

The instrument provides three front-panel keys for controlling windows. They are **Multi Window**, **Zoom**, and **Next Window**. These are all “immediate action” keys.

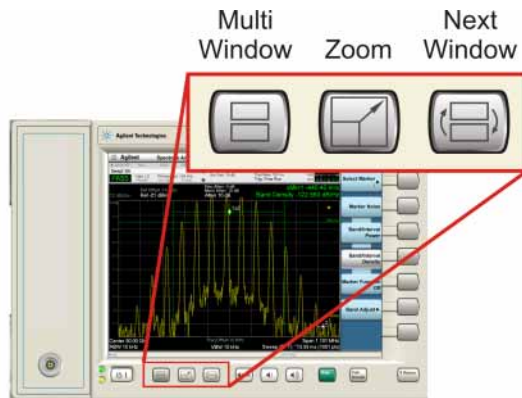

Multi-Window

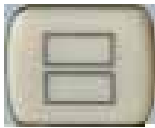

The **Multi Window** front-panel key will toggle you back and forth between the Normal View and the last Multi Window View (Zone Span, Trace Zoom or Spectrogram) that you were in, when using the Swept SA measurement of the Spectrum Analyzer Mode. It remembers which View you were in through a Preset. This “previous view” is set to Zone Span on a Restore Mode Defaults.

Key Path	Front-panel key
Initial S/W Revision	Prior to A.02.00

Zoom

Zoom is a toggle function. Pressing once Zooms the selected window; pressing again un-zooms.

When Zoom is on for a window, that window will get the entire primary display area. The zoomed window, since it is the selected window, is outlined in green.

Zoom is local to each Measurement. Each Measurement remembers its Zoom state. The Zoom state of each Measurement is part of the Mode’s state.

NOTE Data acquisition and processing for the other windows continues while a window is zoomed, as does all SCPI communication with the other windows.

Remote Command	:DISPlay:WINDow:FORMat:ZOOM
Remote Command	:DISPlay:WINDow:FORMat:TILE
Example	:DISP:WIND:FORM:ZOOM sets zoomed :DISP:WIND:FORM:TILE sets un-zoomed
Preset	TILE
Initial S/W Revision	Prior to A.02.00

Next Window

Selects the next window of the current view. When the Next Window key is pressed, the next window in the order of precedence becomes selected. If the selected window was zoomed, the next window will also be zoomed.

The window numbers are as follows. Note that these numbers also determine the order of precedence (that is, Next Window goes from 1 to 2, then 2 to 3, etc.):

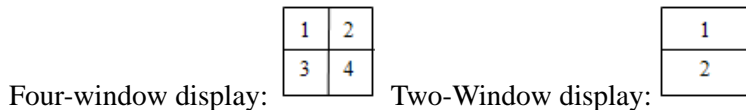

Remote Command	:DISPlay:WINDow[:SElect] <number> :DISPlay:WINDow[:SElect]?
Example	:DISP:WIND 1
Preset	1
Min	1
Max	If <number> is greater than the number of windows, limit to <number of windows>
Initial S/W Revision	Prior to A.02.00

One and only one window is always selected. The selected window has the focus; this means that all window-specific key presses apply only to that window. You can tell which window is selected by the thick green border around it. If a window is not selected, its boundary is gray.

If a window in a multi-window display is zoomed it is still outlined in green. If there is only one window, the green outline is not used. This allows the user to distinguish between a zoomed window and a display with only one window.

The selected window is local to each Measurement. Each Measurement remembers which window is selected. The selected window for each Measurement is remembered in Mode state.

NOTE When this key is pressed in Help Mode, it toggles focus between the table of

contents window and the topic pane window.

Mouse and Keyboard Control

If you do not have access to the instrument front-panel, there are several ways that a mouse and PC Keyboard can give you access to functions normally accessed using the front-panel keys.

Right-Click

If you plug in a mouse and right-click on the analyzer screen, a menu will appear as below:

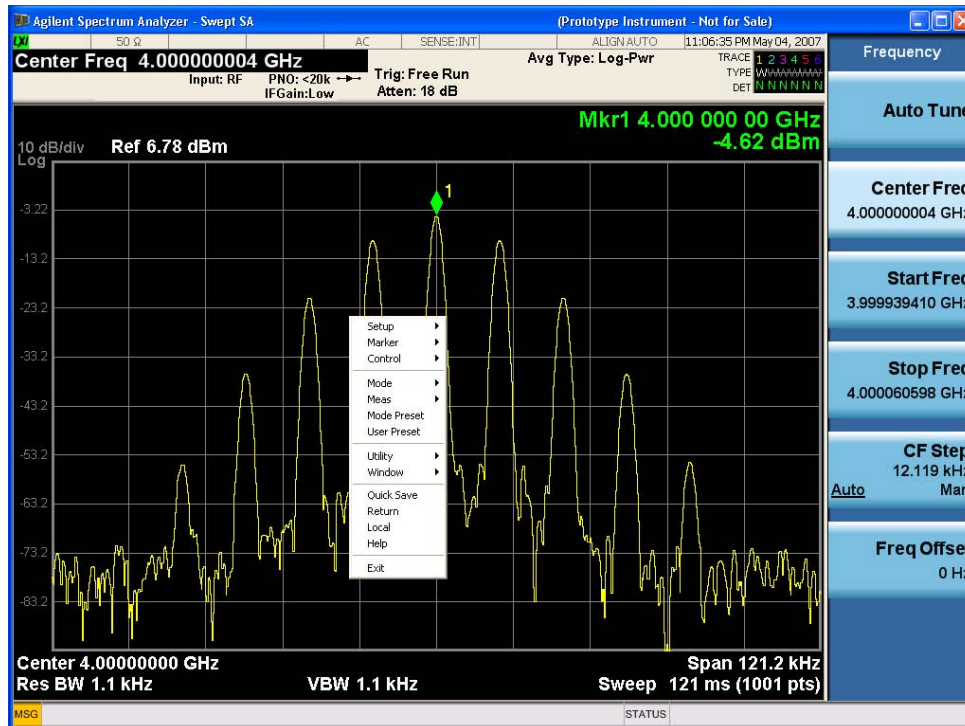

Placing the mouse on one of the rows marked with a right arrow symbol will cause that row to expand, as for example below where the mouse is hovered over the “Utility” row:

About the Analyzer Mouse and Keyboard Control

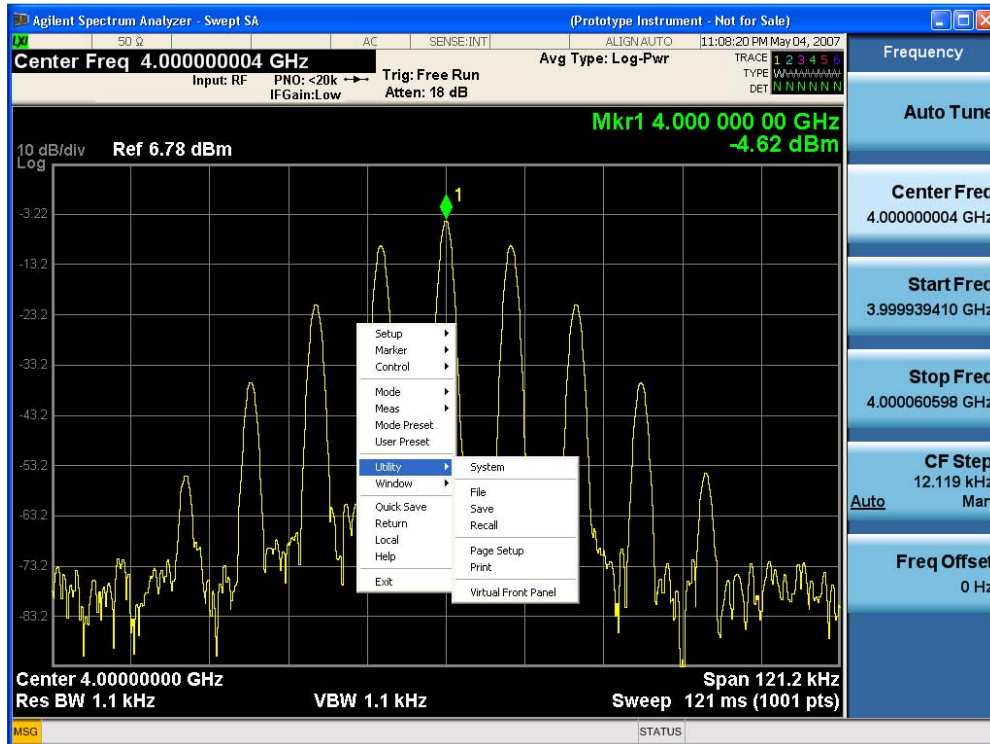

This method can be used to access any of the front-panel keys by using a mouse; as for example if you are accessing the instrument through Remote Desktop.

The array of keys thus available is shown below:

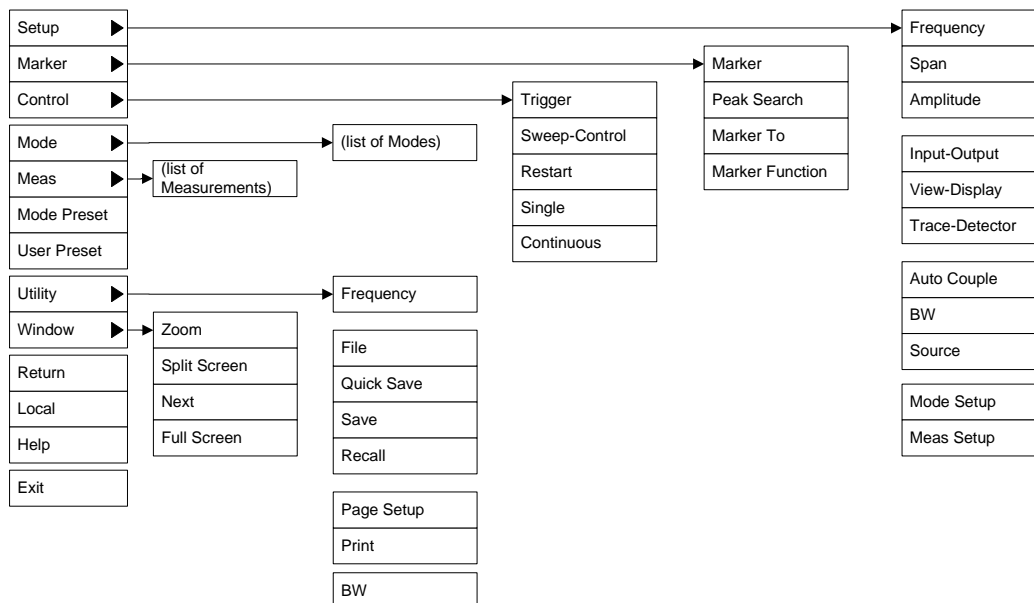

PC Keyboard

If you have a PC keyboard plugged in (or via Remote Desktop), certain key codes on the PC keyboard

map to front-panel keys on the GPSA front panel. These key codes are shown below:

Front-panel key	Key code
Frequency	CTRL+SHIFT+F
Span	CTRL+SHIFT+S
Amplitude	CTRL+SHIFT+A
Input/Output	CTRL+SHIFT+O
View/Display	CTRL+SHIFT+V
Trace/Detector	CTRL+ALT+T
Auto Couple	CTRL+SHIFT+C
Bandwidth	CTRL+ALT+B
Source	CTRL+SHIFT+E
Marker	CTRL+ALT+K
Peak Search	CTRL+ALT+P
Marker To	CTRL+ALT+N
Marker Function	CTRL+ALT+F
System	CTRL+SHIFT+Y
Quick Save	CTRL+Q
Save	CTRL+S
Recall	CTRL+R
Mode Preset	CTRL+M
User Preset	CTRL+U
Print	CTRL+P
File	CTRL+SHIFT+L
Mode	CTRL+SHIFT+M
Measure	CTRL+ALT+M
Mode Setup	CTRL+SHIFT+E
Meas Setup	CTRL+ALT+E
Trigger	CTRL+SHIFT+T
Sweep/Control	CTRL+SHIFT+W
Restart	CTRL+ALT+R
Single	CTRL+ALT+S

Cont	CTRL+ALT+C
Zoom	CTRL+SHIFT+Z
Next Window	CTRL+SHIFT+N
Split Screen	CTRL+L
Full Screen	CTRL+SHIFT+B
Return	CTRL+SHIFT+R
Mute	Mute
Inc Audio	Volume Up
Dec Audio	Volume Down
Help	F1
Control	CTRL
Alt	ALT
Enter	Return
Cancel	Esc
Del	Delete
Backspace	Backspace
Select	Space
Up Arrow	Up
Down Arrow	Down
Left Arrow	Left
Right Arrow	Right
Menu key 1	CTRL+SHIFT+F1
Menu key 2	CTRL+SHIFT+F2
Menu key 3	CTRL+SHIFT+F3
Menu key 4	CTRL+SHIFT+F4
Menu key 5	CTRL+SHIFT+F5
Menu key 6	CTRL+SHIFT+F6
Menu key 7	CTRL+SHIFT+F7
Backspace	BACKSPACE
Enter	ENTER
Tab	Tab
1	1

2	2
3	3
4	4
5	5
6	6
7	7
8	8
9	9
0	0

This is a pictorial view of the table:

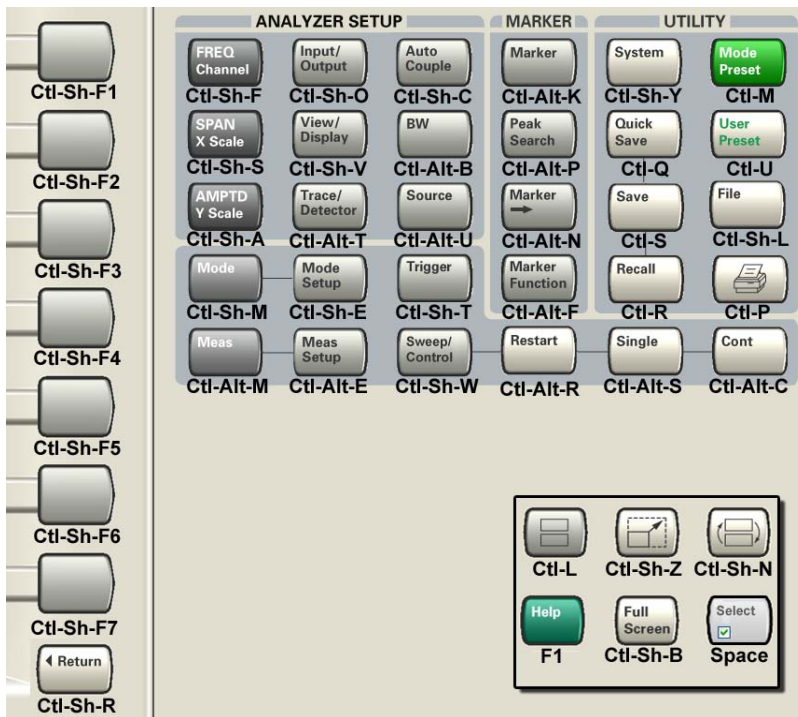

Instrument Security & Memory Volatility

If you are using the instrument in a secure environment, you may need details of how to clear or sanitize its memory, in compliance with published security standards of the United States Department of Defense, or other similar authorities.

For the X Series analyzers, this information is contained in the document "Security Features and Certificate of Volatility". This document is **not** included in the Documentation CD, or the instrument's on-disk library, but it may be downloaded from Agilent's web site.

To obtain a copy of the document, click on or browse to the following URL:

<http://www.agilent.com/find/security>

To locate and download the document, select Model Number "N9020A", then click "Submit". Then, follow the on-screen instructions to download the file.

3

About the N9080A LTE Measurement Application

This chapter provides overall information on the Agilent N9080A LTE Measurement Application and describes the measurements made by the analyzer. Installation instructions for adding this option to your analyzer are provided in this section, in case you purchased this option separately.

What Does the Agilent N9080A LTE Measurement Application Do?

The N9080A LTE is a full-featured LTE signal analyzer that can help determine if an modulated source or transmitter is working correctly. There are standard and optional settings to enable complete analysis of LTE communications signals.

The N9080A 1FP LTE measurement application provides:

- Uplink (SC-FDMA), downlink (OFDMA), and Tx Diversity, MIMO analysis
- All LTE bandwidths: 1.4 MHz to 20 MHz
- All LTE modulation formats and sequences: BPSK, QPSK, 16QAM, 64QAM, CAZAC (Zadoff-Chu) Both downlink (OFDMA) and uplink (SC-FDMA) analysis
- Support for all LTE uplink channels and signals: PUSCH DM-RS, PUSCH, PUCCH DM-RS, and PUCCH
- Support for all LTE downlink channels and signals: RS, P-SS, S-SS, P-BCH, PDCCH, PCFICH, PHICH, and PDSCH
- View signal by: resource block, sub-carrier, slot, or symbol—select all or specific region for analysis. 2D graphical interface shows pictorial representation of user allocation
- Flexible display: Up to four simultaneous user-controllable trace displays
- Flexible markers: Up to 12 markers that can be coupled across different measurements
- X-Series front-panel operation with SCPI programmability
- Compatibility with all X-Series (MXA/EXA/CXA) signal analyzers
- Monitor Spectrum measurement for viewing signal spectrum

The N9080A 1FP LTE measurement application supports the following standards:

- 3GPP TS 36.101 V9.4.0 (2010-06)
- 3GPP TS 36.104 V9.4.0 (2010-06)
- 3GPP TS 36.211 V9.1.0 (2010-03)
- 3GPP TS 36.212 V9.3.0 (2010-03)
- 3GPP TS 36.213 V9.2.0 (2010-06)

This chapter provides introductory information about the programming documentation included with your product.

What Programming Information is Available?

The X-Series Documentation can be accessed through the Additional Documentation page in the instrument Help system and is included on the Documentation CD shipped with the instrument. It can also be found in the instrument at: C:\ProgramsFiles\Agilent\SignalAnalysis\Infrastructure\Help\otherdocs, or online at: http://www.agilent.com/find/mxa_manuals.

The following resources are available to help you create programs for automating your X-Series measurements:

Resource	Description
X-Series Programmer's Guide	<p>Provides general SCPI programming information on the following topics:</p> <ul style="list-style-type: none"> • Programming the X-Series Applications • Programming fundamentals • Programming examples <p>Note that SCPI command descriptions for measurement applications are NOT in this book, but are in the User's and Programmer's Reference.</p>
User's and Programmer's Reference manuals	<p>Describes all front-panel keys and softkeys, including SCPI commands for a measurement application. Note that:</p> <ul style="list-style-type: none"> • Each measurement application has its own User's and Programmer's Reference. • The content in this manual is duplicated in the analyzer's Help (the Help that you see for a key is identical to what you see in this manual).
Embedded Help in your instrument	<p>Describes all front-panel keys and softkeys, including SCPI commands, for a measurement application.</p> <p>Note that the content that you see in Help when you press a key is identical to what you see in the User's and Programmer's Reference.</p>
X-Series Getting Started Guide	<p>Provides valuable sections related to programming including:</p> <ul style="list-style-type: none"> • Licensing New Measurement Application Software - After Initial Purchase • Configuring instrument LAN Hostname, IP Address, and Gateway Address • Using the Windows XP Remote Desktop to connect to the instrument remotely • Using the Embedded Web Server Telnet connection to communicate SCPI <p>This printed document is shipped with the instrument.</p>
Agilent Application Notes	Printable PDF versions of pertinent application notes.
Agilent VISA User's Guide	Describes the Agilent Virtual Instrument Software Architecture (VISA) library and shows how to use it to develop I/O applications and instrument drivers on Windows PCs.

IEEE Common GPIB Commands

Numeric values for bit patterns can be entered using decimal or hexi-decimal representations. (that is,. 0 to 32767 is equivalent to #H0 to #H7FFF).

Calibration Query

*CAL? Performs a full alignment and returns a number indicating the success of the alignment. A zero is returned if the alignment is successful. A one is returned if any part of the alignment fails. The equivalent SCPI command is CALibrate[:ALL]?

See “Alignments” on page 243 for details of *CAL?.

Clear Status

Clears the status byte register. It does this by emptying the error queue and clearing all bits in all of the event registers. The status byte register summarizes the states of the other registers. It is also responsible for generating service requests.

Key Path	No equivalent key. Related key System, Show Errors, Clear Error Queue
Remote Command	*CLS
Example	*CLS Clears the error queue and the Status Byte Register.
Notes	For related commands, see the SYSTem:ERRor[:NEXT]? command. See also the STATus:PRESet command and all commands in the STATus subsystem.
Status Bits/OPC dependencies	Resets all bits in all event registers to 0, which resets all the status byte register bits to 0 also.
Backwards Compatibility Notes	In general the status bits used in the X-Series status system will be backwards compatible with ESA and PSA. However, note that all conditions will generate events that go into the event log, and some will also generate status bits.
Initial S/W Revision	Prior to A.02.00

Standard Event Status Enable

Selects the desired bits from the standard event status enable register. This register monitors I/O errors and synchronization conditions such as operation complete, request control, query error, device dependent error, status execution error, command error, and power on. The selected bits are OR'd to become a summary bit (bit 5) in the byte register which can be queried.

The query returns the state of the standard event status enable register.

Key Path	No equivalent key. Related key System, Show Errors, Clear Error Queue
----------	--

Remote Command	*ESE <integer> *ESE?
Example	*ESE 36 Enables the Standard Event Status Register to monitor query and command errors (bits 2 and 5). *ESE? Returns a 36 indicating that the query and command status bits are enabled.
Notes	For related commands, see the STATus subsystem and SYSTem:ERRor[:NEXT]? commands.
Preset	255
State Saved	Not saved in state.
Min	0
Max	255
Status Bits/OPC dependencies	Event Enable Register of the Standard Event Status Register.
Initial S/W Revision	Prior to A.02.00

Standard Event Status Register Query

Queries and clears the standard event status event register. (This is a destructive read.) The value returned is a hexadecimal number that reflects the current state (0/1) of all the bits in the register.

Remote Command	*ESR?
Example	*ESR? Returns a 1 if there is either a query or command error, otherwise it returns a zero.
Notes	For related commands, see the STATus subsystem commands.
Preset	0
Min	0
Max	255
Status Bits/OPC dependencies	Standard Event Status Register (bits 0 – 7).
Initial S/W Revision	Prior to A.02.00

Identification Query

Returns a string of instrument identification information. The string will contain the model number, serial number, and firmware revision.

The response is organized into four fields separated by commas. The field definitions are as follows:

- Manufacturer
- Model

- Serial number
- Firmware version

Key Path	No equivalent key. See related key System, Show System.
Remote Command	*IDN?
Example	*IDN? Returns instrument identification information, such as: Agilent Technologies,N9020A,US01020004,A.01.02
Initial S/W Revision	Prior to A.02.00

Instrument Model Number

ID? - Returns a string of the instrument identification. The string will contain the model number.

When in Remote Language compatibility mode the query will return the model number of the emulated instrument, when in any other mode the returned model number will be that of the actual hardware.

Operation Complete

The *OPC command sets bit 0 in the standard event status register (SER) to “1” when pending operations have finished, that is when all overlapped commands are complete. It does not hold off subsequent operations. You can determine when the overlapped commands have completed either by polling the OPC bit in SER, or by setting up the status system such that a service request (SRQ) is asserted when the OPC bit is set.

The *OPC? query returns a “1” after all the current overlapped commands are complete. So it holds off subsequent commands until the "1" is returned, then the program continues. This query can be used to synchronize events of other instruments on the external bus.

Remote Command	*OPC *OPC?
Example	INIT:CONT 0 Selects single sweeping. INIT:IMM Initiates a sweep. *OPC? Holds off any further commands until the sweep is complete.
Status Bits/OPC dependencies	Not global to all remote ports or front panel. *OPC only considers operation that was initiated on the same port as the *OPC command was issued from. *OPC is an overlapped command, but *OPC? is sequential.

Backwards Compatibility Notes	<p>The ESA/PSA/VSA products do not meet all the requirements for the *OPC command specified by IEEE 488.2. This is corrected for X-Series. This will sometimes cause behavior that is not backward compatible, but it will work as customers expect.</p> <p>Commands such as, *OPC/*OPC?/*WAI/*RST used to be global. They considered front panel operation in conjunction with the GPIB functionality. Now they are evaluated on a per channel basis. That is, the various rear panel remote ports and the front panel i/o are all considered separately. Only the functionality initiated on the port where the *OPC was sent, is considered for its operation.</p> <p>*OPC used to hold off until the operation bits were cleared. Now it holds off until all overlapping commands are completed. Also, earlier instruments did not wait for completion of all processes, only the ones identified here (in the STATus:OPERation register):</p> <p>Calibrating: monitored by PSA, ESA, VSA (E4406A)</p> <p>Sweeping: monitored by PSA, ESA, VSA (E4406A)</p> <p>Waiting for Trigger: monitored by PSA, ESA, VSA (E4406A)</p> <p>Measuring: monitored by PSA and ESA (but not in all Modes).</p> <p>Paused: monitored by VSA (E4406A).</p> <p>Printing: monitored by VSA (E4406A).</p> <p>Mass memory busy: monitored by VSA (E4406A).</p>
Initial S/W Revision	Prior to A.02.00

Query Instrument Options

Returns a string of all the installed instrument options. It is a comma separated list with quotes, such as: "503,P03,PFR".

To be IEEE compliant, this command should return an arbitrary ascii variable that would not begin and end with quotes. But the quotes are needed to be backward compatible with previous SA products and software. So, the actual implementation will use arbitrary ascii. But quotes will be sent as the first and last ascii characters that are sent with the comma-separated option list.

Remote Command	*OPT?
Initial S/W Revision	Prior to A.02.00

Recall Instrument State

This command recalls the instrument state from the specified instrument memory register.

- If the state being loaded has a newer firmware revision than the revision of the instrument, no state is recalled and an error is reported
- If the state being loaded has an equal firmware revision than the revision of the instrument, the state will be loaded.

- If the state being loaded has an older firmware revision than the revision of the instrument, the instrument will only load the parts of the state that apply to the older revision.

Remote Command	*RCL <register #>
Example	*RCL 7 Recalls the instrument state that is currently stored in register 7.
Notes	Registers 0 through 6 are accessible from the front panel in menu keys for Recall Registers.
Min	0
Max	127
Status Bits/OPC dependencies	The command is sequential.
Initial S/W Revision	Prior to A.02.00

Save Instrument State

This command saves the current instrument state and mode to the specified instrument memory register.

Remote Command	*SAV <register #>
Example	*SAV 9 Saves the instrument state in register 9.
Notes	Registers 0 through 6 are accessible from the front panel in menu keys for Save Registers.
Min	0
Max	127
Status Bits/OPC dependencies	The command is sequential.
Initial S/W Revision	Prior to A.02.00

Service Request Enable

This command enables the desired bits of the service request enable register.

The query returns the value of the register, indicating which bits are currently enabled.

Remote Command	*SRE <integer> *SRE?
Example	*SRE 22 Enables bits 1, 2, and 4 in the service request enable register.
Notes	For related commands, see the STATus subsystem and SYSTEM:ERRor[:NEXT]? commands.
Preset	0
Min	0

Max	255
Status Bits/OPC dependencies	Service Request Enable Register (all bits, 0 – 7).
Initial S/W Revision	Prior to A.02.00

Status Byte Query

Returns the value of the status byte register without erasing its contents.

Remote Command	*STB?
Example	*STB? Returns a decimal value for the bits in the status byte register. For example, if a 16 is returned, it indicates that bit 5 is set and one of the conditions monitored in the standard event status register is set.
Notes	See related command *CLS.
Status Bits/OPC dependencies	Status Byte Register (all bits, 0 – 7).
Initial S/W Revision	Prior to A.02.00

Trigger

This command triggers the instrument. Use the :TRIGger[:SEquence]:SOURce command to select the trigger source.

Key Path	No equivalent key. See related keys Single and Restart.
Remote Command	*TRG
Example	*TRG Triggers the instrument to take a sweep or start a measurement, depending on the current instrument settings.
Notes	See related command :INITiate:IMMediate.
Initial S/W Revision	Prior to A.02.00

Self Test Query

This query performs the internal self-test routines and returns a number indicating the success of the testing. A zero is returned if the test is successful, 1 if it fails.

Remote Command	*TST?
Example	*TST? Runs the self-test routines and returns 0=passed, 1=some part failed.
Initial S/W Revision	Prior to A.02.00

Wait-to-Continue

This command causes the instrument to wait until all overlapped commands are completed before

executing any additional commands. There is no query form for the command.

Remote Command	*WAI
Example	INIT:CONT OFF; INIT;*WAI Sets the instrument to single sweep. Starts a sweep and waits for its completion.
Status Bits/OPC dependencies	Not global to all remote ports or front panel. *OPC only considers operation that was initiated on the same port as the *OPC command was issued from.
Initial S/W Revision	Prior to A.02.00

File

Opens a menu that enables you to access various standard and custom Windows functions. Press any other front-panel key to exit

Key Path	Front-panel key
Initial S/W Revision	Prior to A.02.00

File Explorer

Opens the standard Windows File Explorer. The File Explorer opens in the My Documents directory for the current user.

The File Explorer is a separate Windows application, so to return to the analyzer once you are in the File Explorer, you may either:

Exit the File Explorer by clicking on the red X in the upper right hand corner, with a mouse

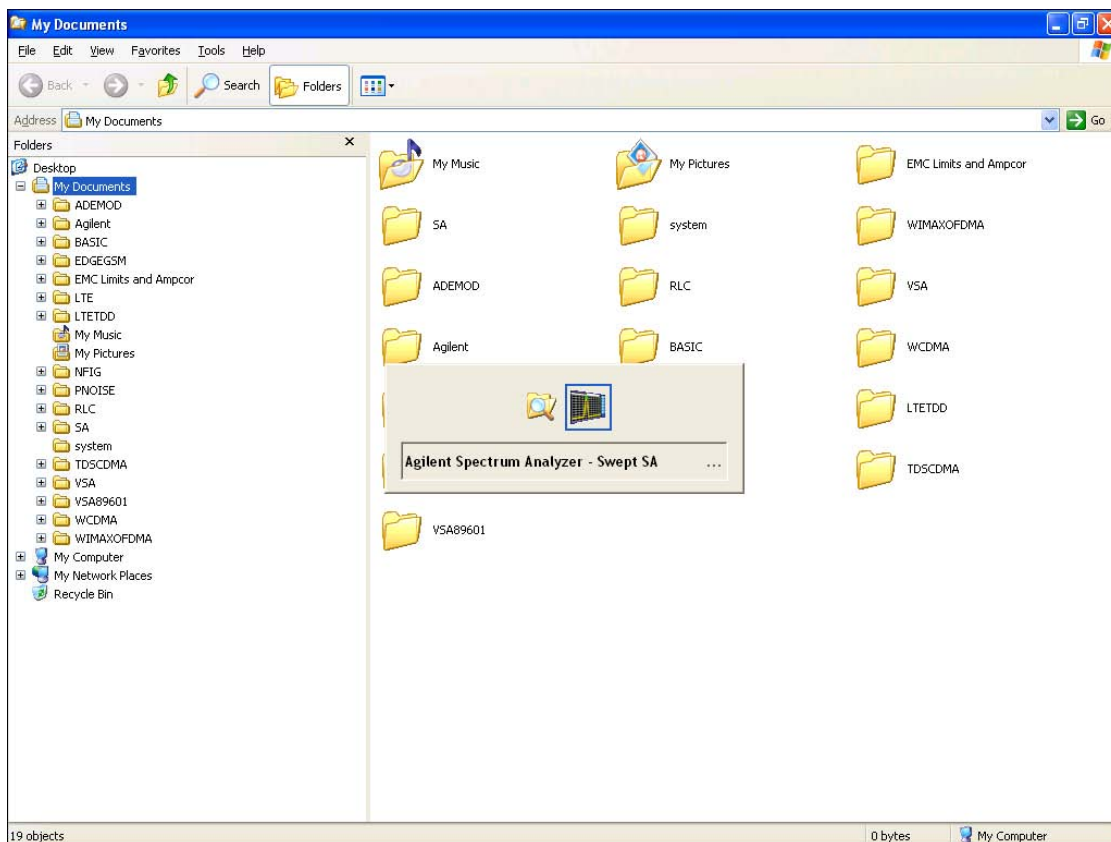

Or use Alt-Tab: press and hold the Alt key and press and release the Tab key until the Analyzer

logo is showing in the window in the center of the screen, as above, then release the Alt key.

Key Path	File
Initial S/W Revision	Prior to A.02.00

Page Setup

The Page Setup key brings up a Windows Page Setup dialog that allows you to control aspects of the pages sent to the printer when the PRINT hardkey is pressed.

Key Path	File
Initial S/W Revision	Prior to A.02.00

Paper size, the printer paper source, the page orientation and the margins are all settable. Just like any standard Windows dialog, you may navigate the dialog using front-panel keys, or a mouse. There are no SCPI commands for controlling these parameters.

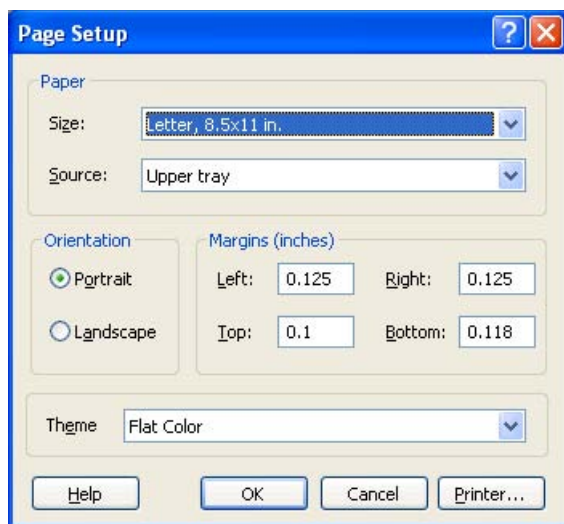

Also contained in this dialog is a drop-down control that lets you select the Theme to use when printing. For more on Themes, see information under View/Display, Display, System Display Settings, Theme. The Theme control has a corresponding SCPI command.

Parameter Name	Print Themes
Parameter Type	Enum
Mode	All
Remote Command	:SYSTem:PRINT:THEME TDCOLOR TDMONochrome FCOLOR FMONochrome :SYSTem:PRINT:THEME?
Example	:SYST:PRIN:THEM FCOL

Setup	:SYSTEM:DEFault MISC
Preset	FCOL; not part of Preset, but is reset by Restore Misc Defaults or Restore System Defaults All and survives subsequent running of the modes.
State Saved	No
Initial S/W Revision	Prior to A.02.00

Print

The Print key opens a Print dialog for configured printing (for example, to the printer of your choice). Refer to your Microsoft Windows Operating System manual for more information.

Maximize/Restore Down

These keys allow the Instrument Application to be maximized and then restored to its prior state. Only one of the two keys is visible at a time. When not already maximized the Maximize Application key is visible, and when maximized, the Restore Down Application key is visible and replaces the Maximize Application key.

Maximize

This key allows you to Maximize the Instrument Application, which causes the analyzer display to fill the screen. Once the application is maximized, this key is replaced by the Restore Down key.

Key Path	File
Mode	All
Notes	No equivalent remote command for this key.
State Saved	No
Initial S/W Revision	A.05.01

Restore Down

This key allows you to Restore Down the Instrument Application and reverses the action taken by Maximize. This key is only visible when the application has been maximized, and after the Restore Down action has been completed this key is replaced by the Maximize key.

Key Path	File
Mode	All
Notes	No equivalent remote command for this key.
State Saved	No
Initial S/W Revision	A.05.01

Minimize

The Minimize key causes the analyzer display to disappear down into the task bar, allowing you to see

the Windows Desktop. You can use Alt-Tab (press and hold the Alt  key and press and release the Tab key) to restore the analyzer display.

Key Path	File
Mode	All
Notes	No equivalent remote command for this key.
State Saved	No
Initial S/W Revision	A.05.01

Exit

This key, when pressed, will exit the Instrument Application. A dialog box is used to confirm that you intended to exit the application:

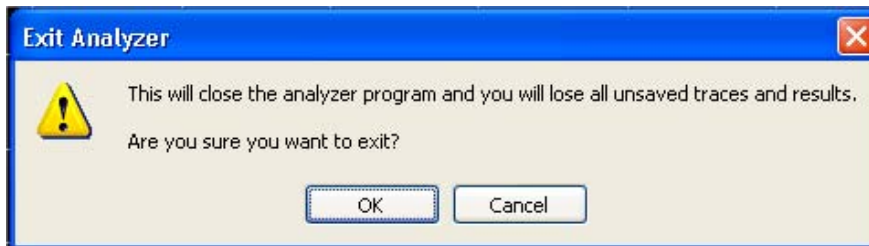

Key Path	File
Mode	All
Notes	The Instrument Application will close. No further SCPI commands can be sent. Use with caution!
Initial S/W Revision	Prior to A.02.00

Mode Preset

Returns the active mode to a known state.

Mode Preset does the following for the currently active mode:

- Aborts the currently running measurement.
- Brings up the default menu for the mode, with no active function.
- Sets measurement Global settings to their preset values for the active mode only.
- Activates the default measurement.
- Brings up the default menu for the mode.
- Clears the input and output buffers.
- Sets Status Byte to 0.

Mode Preset does not:

- Cause a mode switch
- Affect mode persistent settings
- Affect system settings

See [“How-To Preset” on page 187](#) for more information.

Key Path	Front-panel key
Remote Command	:SYSTem:PRESet
Example	:SYST:PRES
Notes	*RST is preferred over :SYST:PRES for remote operation. *RST does a Mode Preset, as done by the :SYST:PRES command, and it sets the measurement mode to Single measurement rather than Continuous for optimal remote control throughput. Clears all pending OPC bits. The Status Byte is set to 0.
Couplings	A Mode Preset aborts the currently running measurement, activates the default measurement, and gets the mode to a consistent state with all of the default couplings set.

Backwards Compatibility Notes	<p>In the X-Series, the legacy “Factory Preset” has been replaced with Mode Preset, which only presets the currently active mode, not the entire instrument. In the X-Series, the way in to preset the entire instrument is by using System, Restore System Defaults All, which behaves essentially the same way as restore System Defaults does on ESA and PSA.</p> <p>There is also no “Preset Type” as there is on the PSA. There is a green Mode Preset front-panel key that does a Mode Preset and a white-with-green-letters User Preset front-panel key that does a User Preset. The old PRESet:TYPE command is ignored (without generating an error), and SYST:PRES without a parameter does a Mode Preset, which should cover most backward code compatibility issues.</p> <p>The settings and correction data under the Input/Output front-panel key (examples: Input Z Corr, Ext Amp Gain, etc.) are no longer part of any Mode, so they will not be preset by a Mode Preset. They are preset using Restore Input/Output Defaults, Restore System Defaults All. Note that because User Preset does a Recall State, and all of these settings are saved in State, they ARE recalled when using User Preset.</p>
Initial S/W Revision	Prior to A.02.00

How-To Preset

The table below shows all possible presets, their corresponding SCPI commands and front-panel access (key paths). Instrument settings depend on the current measurement context. Some settings are local to the current measurement, some are global (common) across all the measurements in the current mode, and some are global to all the available modes. In a similar way, restoring the settings to their preset state can be done within the different contexts.

Auto Couple - is a measurement local key. It sets all Auto/Man parameter couplings in the measurement to Auto. Any Auto/Man selection that is local to other measurements in the mode will not be affected.

Meas Preset - is a measurement local key. Meas Preset resets all the variables local to the current measurement except the persistent ones.

Mode Preset - resets all the current mode's measurement local and measurement global variables except the persistent ones.

Restore Mode Defaults - resets ALL the Mode variables (and all the Meas global and Meas local variables), including the persistent ones.

Type Of Preset	SCPI Command	Front Panel Access
Auto Couple	:COUPle ALL	Auto Couple front-panel key
Meas Preset	:CONFigure:<Measurement>	Meas Setup Menu
Mode Preset	:SYSTem:PRESet	Mode Preset (green key)
Restore Mode Defaults	:INSTrument:DEFault	Mode Setup Menu
Restore All Mode Defaults	:SYSTem:DEFault MODes	System Menu; Restore System Default Menu

System Functions
Mode Preset

Type Of Preset	SCPI Command	Front Panel Access
*RST	*RST	not possible (Mode Preset with Single)
Restore Input/Output Defaults	:SYSTem:DEFault INPut	System Menu; Restore System Default Menu
Restore Power On Defaults	:SYSTem:DEFault PON	System Menu; Restore System Default Menu
Restore Alignment Defaults	:SYSTem:DEFault ALIGn	System Menu; Restore System Default Menu
Restore Miscellaneous Defaults	:SYSTem:DEFault MISC	System Menu; Restore System Default Menu
Restore All System Defaults	:SYSTem:DEFault [ALL] :SYSTem:PRESet:PERsistent	System Menu; Restore System Default Menu
User Preset	:SYSTem:PRESet:USER	User Preset Menu
User Preset All Modes	:SYSTem:PRESet:USER:ALL	User Preset Menu
Power On Mode Preset	:SYSTem:PON:TYPE MODE	System Menu
Power On User Preset	:SYSTem:PON:TYPE USER	System Menu
Power On Last State	:SYSTem:PON:TYPE LAST	System Menu

Restore Mode Defaults

Resets the state for the currently active mode by resetting the mode persistent settings to their factory default values, clearing mode data and by performing a Mode Preset. This function will never cause a mode switch. This function performs a full preset for the currently active mode; whereas, Mode Preset performs a partial preset. Restore Mode Defaults does not affect any system settings. System settings are reset by the Restore System Defaults function. This function does reset mode data; as well as settings.

Key Path	Mode Setup
Remote Command	:INSTrument:DEFault
Example	:INST:DEF
Notes	Clears all pending OPC bits. The Status Byte is set to 0. A message comes up saying: "If you are sure, press key again".
Couplings	A Restore Mode Defaults will cause the currently running measurement to be aborted and causes the default measurement to be active. It gets the mode to a consistent state with all of the default couplings set.
Initial S/W Revision	Prior to A.02.00

Meas Preset

Resets the measurement local variables for the currently active measurement to their factory default values. The measurement settings that get reset are the same ones that are reset during a Mode Preset. This function keeps the instrument in the current measurement and the current mode and does not affect the settings for other measurements, but does abort the currently running measurement.

Key Path	Meas Setup
Remote Command	:CONFigure:<Measurement>
Example	:CONF:ACP immediately does a Meas Preset to the ACP measurement.
Notes	<p>Clears the Measuring bit</p> <p>:CONF:<Measurement> resets the specified measurement settings to default in ESA, VSA and PSA; in GPSA it allows the addition of the NDEFault node to the command to prevent a measurement preset from occurring after a measurement switch.</p> <p>:MEASure:<Measurement> also restores the default values of the selected measurement, but it also initiates the specified measurement.</p>
Initial S/W Revision	Prior to A.02.00

Preset Type (Remote Command Only)

As stated in the Backward Compatibility section, to be compatible with ESA/PSA the PRESet:TYPE command will be implemented as a no-op.

Mode	All
Remote Command	:SYSTem:PRESet:TYPE FACTory MODE USER :SYSTem:PRESet:TYPE?
Example	:SYST:PRESet:TYPE FACT
Notes	This command is supported for backward compatibility only. It is a no-op which does not change the behavior of any preset operation.
Preset	This is unaffected by Preset but is set to Mode on a “Restore System Defaults->All”
State Saved	No
Initial S/W Revision	Prior to A.02.00

*RST (Remote Command Only)

*RST is equivalent to :SYST:PRESet::INIT:CONT OFF which is a Mode Preset in the Single measurement state. This remote command is preferred over Mode Preset remote command - :SYST:PRESet, as optimal remote programming occurs with the instrument in the single measurement

System Functions
Mode Preset

state.

Remote Command	*RST
Example	*RST
Notes	Sequential Clears all pending OPC bits and the Status Byte is set to 0.
Couplings	A *RST will cause the currently running measurement to be aborted and cause the default measurement to be active. *RST gets the mode to a consistent state with all of the default couplings set.
Backwards Compatibility Notes	In legacy analyzers *RST did not set the analyzer to Single, but in the X-Series it does, for compliance with the IEEE 488.2 specification. In the X-Series, *RST does not do a *CLS (clear the status bits and the error queue). In legacy analyzers, *RST used to do the equivalent of SYSTem:PRESet, *CLS and INITiate:CONTinuous OFF. But to be 488.2 compliant, *RST in the X-Series does not do a *CLS.
Initial S/W Revision	Prior to A.02.00

Print

This front-panel key is equivalent to performing a File, Print, OK. It immediately performs the currently configured Print to the Default printer.

The :HCOPY command is equivalent to pressing the PRINT key. The HCOpy:ABORt command can be used to abort a print which is already in progress. Sending HCOpy:ABORt will cause the analyzer to stop sending data to the printer, although the printer may continue or even complete the print, depending on how much data was sent to the printer before the user sent the ABORt command.

Key Path	Front-panel key
Remote Command	:HCOPY[:IMMediate]
Initial S/W Revision	Prior to A.02.00

Key Path	SCPI command only
Remote Command	:HCOpy:ABORt
Initial S/W Revision	Prior to A.02.00

Quick Save

The Quick Save front-panel key repeats the most recent save that was performed from the Save menu, with the following exceptions:

Register saves are not remembered as Saves for the purpose of the Quick Save function

If the current measurement does not support the last non-register save that was performed, an informational message is generated, “File type not supported for this measurement”

Quick Save repeats the last type of qualified save (that is, a save qualified by the above criteria) in the last save directory by creating a unique filename using the Auto File Naming algorithm described below.

If Quick Save is pressed after startup and before any qualified Save has been performed, the Quick Save function performs a Screen Image save using the current settings for Screen Image saves (current theme, current directory), which then becomes the “last save” for the purpose of subsequent Quick Saves.

The Auto File Naming feature automatically generates a file name for use when saving a file. The filename consists of a prefix and suffix separated by a dot, as is standard for the Windows® file system. A default prefix exists for each of the available file types:

Type	Default Prefix	Menu
State	State_	(Save/Recall)
Trace + State	State_	(Save/Recall)
Screen	Screen_	(Save/Recall)
Amplitude Corrections	Ampcor_	(Import/Export)
Traces	Trace_	(Import/Export)
Limit Lines	LLine_	(Import/Export)
Measurement Result	MeasR_	(Import/Export)
Capture Buffer	CapBuf_	(Import/Export)

A four digit number is appended to the prefix to create a unique file name. The numbering sequence starts at 0000 within each Mode for each file type and updates incrementally to 9999, then wraps to 0000 again. It remembers where it was through a Mode Preset and when leaving and returning to the Mode. It is reset by Restore Misc Defaults and Restore System Defaults and subsequent running of the instrument application. So, for example, the first auto file name generated for State files is State_0000.state. The next is State_0001, and so forth.

One of the key features of Auto File Name is that we guarantee that the Auto File Name will never conflict with an existing file. The algorithm looks for the next available number. If it gets to 9999, then it looks for holes. If it find no holes, that is no more numbers are available, it gives an error.

For example, if when we get to State_0010.state there is already a State_0010.state file in the current directory, it advances the counter to State_0011.state to ensure that no conflict will exist (and then it verifies that State_0011.state also does not exist in the current directory and advances again if it does,

and so forth).

If you enter a file name for a given file type, then the prefix becomes the filename you entered instead of the default prefix, followed by an underscore. The last four letters (the suffix) are the 4-digit number.

For example, if you save a measurement results file as “fred.csv”, then the next auto file name chosen for a measurement results save will be fred_0000.csv.

NOTE Although 0000 is used in the example above, the number that is used is actually the current number in the Meas Results sequence, that is, the number that would have been used if you had not entered your own file name.

NOTE If the filename you entered ends with _dddd, where d=any number, making it look just like an auto file name, then the next auto file name picks up where you left off with the suffix being dddd + 1.

Key Path	Front-panel key
Notes	No remote command for this key specifically.
Initial S/W Revision	Prior to A.02.00

Recall

In the LTE FDD/TDD modes, four types of recall functions are available under the Data menu: Limit Mask, E-UTRA Test Model, Signal Studio Setup and Vector Signal Analyzer. Limit Mask enables setting a preset limit mask for Power Suite-based measurements, and currently it is available for the SEM/ACP measurements with the LTE FDD/TDD modes. Recalling E-UTRA Test Model sets complicated RB settings for each Test Model for the Modulation Analysis and Conformance EVM measurements. Recalling Signal Studio Setup or 89600 Vector Signal Analyzer enables you to recall parameters that were set and saved on the external platform.

Key Path	Front Panel
Mode	LTE, LTETDD
Initial S/W Revision	Prior to A.02.00
Modified at S/W Revision	A.06.00, A.08.00

State

Accesses a menu that enables you to recall a State that has previously been saved. Recalling a saved state returns the analyzer as close as possible to the mode context and may cause a mode switch if the file selected is not for the current active mode. A State file can be recalled from either a register or a file. Once you select the source of the recall in the State menu, the recall will occur.

See [“More Information” on page 194](#).

Key Path	Recall
Mode	All
Example	MMEM:LOAD:STAT "MyStateFile.state" This loads the state file data (on the default file directory path) into the instrument state.
Notes	See “Open” on page 196 .
Initial S/W Revision	Prior to A.02.00

More Information

In measurements that support saving Traces, for example, Swept SA, the Trace data is saved along with the State in the State file. When recalling the State, the Trace data is recalled as well. Traces are recalled exactly as they were stored, including the writing mode and update and display modes. If a Trace was updating and visible when the State was saved, it will come back updating and visible, and its data will be rewritten right away. When you use State to save and recall traces, any trace whose data must be preserved should be placed in View or Blank mode before saving.

The following table describes the Trace Save and Recall possibilities:

You want to recall state and one trace's data, leaving other traces unaffected.	Save Trace+State from 1 trace. Make sure that no other traces are updating (they should all be in View or Blank mode) when the save is performed.	On Recall, specify the trace you want to load the one trace's data into. This trace will load in View. All other traces' data will be unaffected, although their trace mode will be as it was when the state save was performed.
You want to recall all traces	Save Trace+State from ALL traces.	On Recall, all traces will come back in View (or Blank if they were in Blank or Background when saved)
You want all traces to load exactly as they were when saved.	Save State	On recall, all traces' mode and data will be exactly as they were when saved. Any traces that were updating will have their data immediately overwritten.

Register 1 thru Register 6

Selecting any one of these register keys causes the State of the mode from the specified Register to be recalled. Each of the register keys annotates whether it is empty or at what date and time it was last modified.

Registers are shared by all modes, so recalling from any one of the 6 registers may cause a mode switch to the mode that was active when the save to the Register occurred.

After the recall completes, the message "Register <register number> recalled" appears in the message bar. If you are in the Spectrum Analyzer Mode, and you are recalling a register that was saved in the Spectrum Analyzer Mode, then after the recall, you will still be in the Recall Register menu. If the Recall causes you to switch modes, then after the Recall, you will be in the Frequency menu.

Key Path	Recall, State
Example	*RCL 1
Readback	Date and time with seconds resolution of the last Save is displayed on the key, or "(empty)" if no prior save operation performed to this register.
Initial S/W Revision	Prior to A.02.00

Key Path	Recall, State
Example	*RCL 2
Readback	Date and time with seconds resolution of the last Save is displayed on the key, or "(empty)" if no prior save operation performed to this register.
Initial S/W Revision	Prior to A.02.00

Recall

Key Path	Recall, State
Example	*RCL 3
Readback	Date and time with seconds resolution of the last Save is displayed on the key, or "(empty)" if no prior save operation performed to this register.
Initial S/W Revision	Prior to A.02.00

Key Path	Recall, State
Example	*RCL 4
Readback	Date and time with seconds resolution of the last Save is displayed on the key, or "(empty)" if no prior save operation performed to this register.
Initial S/W Revision	Prior to A.02.00

Key Path	Recall, State
Example	*RCL 5
Readback	Date and time with seconds resolution of the last Save is displayed on the key, or "(empty)" if no prior save operation performed to this register.
Initial S/W Revision	Prior to A.02.00

Key Path	Recall, State
Example	*RCL 6
Readback	Date and time with seconds resolution of the last Save is displayed on the key, or "(empty)" if no prior save operation performed to this register.
Initial S/W Revision	Prior to A.02.00

From File\ File Open

Brings up the standard Windows® File Open dialog and its corresponding key menu.

When you first enter this dialog, the State File default path is in the Look In: box in this File Open dialog. The File Open dialog is loaded with the file information related to the State Save Type. The first *.state file is highlighted. The only files that are visible are the *.state files and the Files of type is *.state, since .state is the file suffix for the State save type. For more details, refer to [“File Open Dialog and Menu” on page 203](#).

Key Path	Recall, State
Notes	Brings up the Open dialog for recalling a State Save Type
Initial S/W Revision	Prior to A.02.00

Open

The recalling State function must first verify the file is recallable in the current instrument by checking

the software version and model number of the instrument. If everything matches, a full recall proceeds by aborting the currently running measurement, and then loading the State from the saved state file to as close as possible to the context in which the save occurred. You can open state files from any mode, so recalling a State file switches to the mode that was active when the save occurred. After switching to the mode of the saved state file, mode settings and data (if any for the mode) are loaded with values from the saved file. The saved measurement of the mode becomes the newly active measurement and the data relevant to the measurement (if there is any) is recalled.

If there is a mismatch between file version or model number or instrument version or model number, the recall function tries to recall as much as possible and it returns a warning message of what it did.

NOTE No Trace data is loaded when recalling a State File. Measurements that support loading of trace data will include a Trace key in the Recall menu and will load State + Trace data from .trace files under that key.

Key Path	Recall, State, From File...
Remote Command	:MMEMory:LOAD:STATe <filename>
Example	:MMEM:LOAD:STAT "myState.state" recalls the file myState.state on the default path
Notes	Auto return to the State menu and the Open dialog goes away. Advisory Event "Recalled File <file name>" after recall is complete.
Notes	If the file specified is empty an error is generated. If the specified file does not exist, another error is generated. If there is a mismatch between the file and the proper file type, an error is generated. If there is a mismatch between file version or model number or instrument version or model number, a warning is displayed. Then it returns to the State menu and File Open dialog goes away.
Backwards Compatibility SCPI	:MMEMory:LOAD:STATe 1,<filename> For backwards compatibility, the above syntax is supported. The "1" is simply ignored.
Initial S/W Revision	Prior to A.02.00

The state of a mode includes all of the variables affected by doing a full preset. It not only recalls Mode Preset settings, but it also recalls all of the mode persistent settings and data if the mode has either. Each mode determines whether data is part of mode state and if the mode has any persistent settings. Recall State also recalls all of the Input/Output system settings, since they are saved with each State File for each mode.

The Recall State function does the following:

- Verifies that the file is recallable on this instrument using the version number and model number.

Recall

- Aborts the currently running measurement.
- Clears any pending operations.
- Switches to the mode of the selected Save State file.
- Sets mode State and Input/Output system settings to the values in the selected Saved State file.
- Limits settings that differ based on model number, licensing or version number.
- Makes the saved measurement for the mode the active measurement.
- Clears the input and output buffers.
- Status Byte is set to 0.
- Executes a *CLS

Data (Import)

Importing a data file loads data that was previously saved from the current measurement or from other measurements and/or modes that produce the same type of data. The Import Menu only contains Data Types that are supported by the current measurement.

Since the commonly exported data files are in .csv format, the data can be edited by the user prior to importing. This allows you to export a data file, manipulate the data in Excel (the most common PC Application for manipulating .csv files) and then import it.

Importing Data loads measurement data from the specified file into the specified or default destination, depending on the data type selected. Selecting an Import Data menu key will not actually cause the importing to occur, since the analyzer still needs to know from where to get the data. Pressing the Open key in this menu brings up the Open dialog and Open menu that provides you with the options from where to recall the data. Once a filename has been selected or entered in the Open menu, the recall occurs as soon as the Open key is pressed.

Key Path	Recall
Mode	All
Notes	The menu is built from whatever data types are available for the mode. Some keys will be missing completely, so the key locations in the sub-menu will vary. No SCPI command directly controls the Data Type that this key controls. The Data Type is included in the MMEM:LOAD commands.
Dependencies	If a file type is not used by a certain measurement, it is grayed out for that measurement. The key for a file type will not show at all if there are no measurements in the Mode that support it.
Preset	Is not affected by Preset or shutdown, but is reset during Restore Mode Defaults
Readback	The data type that is currently selected
Initial S/W Revision	Prior to A.02.00

Import Trace Data

See “Import Trace Data” on page 1711.

Signal Studio Setup

Enables you to recall the Agilent Signal Studio setup file created using Signal Studio (N7624B/N7625B). This key is valid only for the Modulation Analysis measurement.

For the supported carrier types, see the table below:

Signal Studio	Carrier Type
N7624B Signal Studio for 3GPP LTE	Advanced LTE FDD Downlink (2009–03) Advanced LTE FDD Downlink (2009–12) Basic LTE FDD Downlink (2009–03) Basic LTE FDD Downlink (2009–12) Basic LTE FDD Uplink (2009–03) Basic LTE FDD Uplink (2009–12) Basic LTE FDD Downlink (2010-06) Basic LTE FDD Uplink (2010-06) Advanced LTE FDD Downlink (2010-06) Advanced LTE FDD Uplink (2009-12) Advanced LTE FDD Uplink (2010-06)
N7625B Signal Studio for 3GPP LTE TDD	Advanced LTE TDD(2009–03) Advanced LTE TDD(2009–12) Basic LTE TDD(2009–03) Basic LTE TDD(2009–12) Basic LTE TDD (2010-06) Advanced LTE TDD (2010-06)

File Location and Extension

File location: “My Documents\LTE\LTE_TDD\data”

File type: xml

File extension: .scp

Place the Signal Studio setup file that was created using the N7624B/N7625B in the above directory. When you select **OPEN** under the Import Data menu, the directory opens enabling you to select your setup file.

Example:

File Location: My Documents\LTE_FDD\data

System Functions

Recall

File Name: Uplink PRACH.scp

Key Path	Recall, Data
Mode	LTE, LTETDD
Remote Command	MMEMoRY:LOAD:SSSetup <string>
Example	MMEMoRY:LOAD:SSS "Uplink PRACH.scp"
Notes	Sets of parameters related to Signal Studio Setup are overwritten by the contents of the setup file.
Initial S/W Revision	A.06.00

Vector Signal Analyzer Setup

This key enables you to recall the 89600 Vector Signal Analyzer Setup file that was created using the 89600 Vector Signal Analyzer Option BHD (LTE FDD) and Option BHE (LTE TDD). This key is valid only for the Modulation Analysis measurement.

File Location and Extension

File location: "My Documents\LTE\LTE_TDD\data" folder

File type: text file

File extension: .set, .setx

Place the 89600 Vector Signal Analyzer setup file that was created using the 89600 in the above directory. When you select **OPEN** under the Import Data menu, the directory opens enabling you to select your setup file.

Example:

File Location: My Documents\LTE_FDD\data

File Name: Uplink PRACH.set

Key Path	Recall, Data
Mode	LTE, LTETDD
Remote Command	MMEMoRY:LOAD:VSASetup <string>
Example	MMEMoRY:LOAD:VSAS "Uplink PRACH.set"
Notes	Sets of parameters related to Vector Signal Analyzer Setup are overwritten by the contents of the setup file.
Initial S/W Revision	A.06.00

Masks

This key enables you to recall a preset mask file from the list. The preset mask file contains configuration for only Carrier, Offset, Limit settings and the preset profile BW. Any set of values not specified by the preset mask file will not be overwritten.

You cannot change or create the preset mask file since it is a binary file. This key is valid for the Spectrum Emission Mask and ACP measurements.

File location: “My Documents\LTE\LTE_TDD\data\masks”

Note that “**My Documents**” is an alias to a directory and its location depends on which user is logged in. At XSA start up, all of the limit mask files in the current user’s “My Documents\LTE\LTE_TDD\data\masks” directory are overwritten.

File type: Binary

Filename: The filename follows the rule below with the words connected using underscores.

<Measurement>_<Direction>_<Bandwidth>_<Condition>.mask

Where

<Measurement> Measurement the limit mask file is applied to: SEM or ACP

<Direction> Direction: BS (Downlink) or MS (Uplink).

<Bandwidth> Bandwidth

<Condition> Condition. It depends on the measurement.

File extension: .mask

Selecting **OPEN** under the Import Data menu, opens the above directory enabling you to select a mask file. When you change the Bandwidth or Direction, all Power Suite measurement parameters are reset to the hard coded preset parameters. Therefore, you must recall the appropriate preset mask file again after the change.

You cannot read the contents of the provided preset mask file since it is a binary file. Detailed contents of the file are provided in a PDF file located in the same directory as the preset mask file.

Example:

File Location: My Documents/LTE_FDD/data/masks/SEM_MS

File Name: SEM_MS_15MHz_Add_NS04.mask

The following table shows the sets of variables imported to the ACP measurement.

Offset	Start Freq (MHz)	Stop Freq (MHz)	Res BW (Hz)	Meas BW	Rel Start	Rel Stop	Fail Mask
A	5	7.14	30k	1	-8	-25	Rel
B	7.14	10.57	30k	1	-25	-27	Rel
C	10.57	20	30k	1	-27	-50	Rel
D	20	25	30k	1	-50	-50	Rel
E	25	30	30k	1	-50	-50	Rel

System Functions
Recall

Key Path	Recall, Data
Mode	LTE, LTETDD
Remote Command	MMEMOry:LOAD:MASK <string>
Example	MMEM:LOAD:MASK “ACP_BS\ACP_BS_3MHz_pairE-UTRA_CatA.mask”
Notes	Sets of parameters related to Limit, Carrier and Offset are overwritten by the contents of the preset mask file.
Initial S/W Revision	A.03.00

EVM Setup

This key enables you to recall EVM parameter setting to measure E-UTRA Test Model in the 3GPP standard (36.141–810 6.1.1).

E-UTRA Test Model 1.1 (E-TM1.1)

E-UTRA Test Model 1.2 (E-TM1.2)

E-UTRA Test Model 2 (E-TM2)

E-UTRA Test Model 3.1 (E-TM3.1)

E-UTRA Test Model 3.2 (E-TM3.2)

E-UTRA Test Model 3.3 (E-TM3.3)

This key is valid for the Modulation Analysis and Conformance EVM measurements only.

File Location and Extension

File location: My Documents\LTE\LTE_TDD\data\evmsetup

Note that “My Documents” is an alias to a directory and its location depends on which user is logged in. At XSA start up, all of the EVM Setup files in the current user’s “My Documents\LTE\LTE_TDD\data\evmsetup” directory are overwritten.

File type: binary

File extension: .evms

Selecting **OPEN** under the Import Data menu, opens the above directory enabling you to select an EVM Setup file. When you change the Bandwidth, parameters are reset to the hard coded preset parameters. Therefore, you must recall the appropriate EVM Setup file again after the change.

You cannot read the contents of the provided EVM Setup file since it is a binary file.

Example:

File Location: My Documents/LTE_FDD/data/evmsetup

Filename: TM3.1-BW1.4MHz.evms

Key Path	Recall, Data
----------	--------------

Mode	LTE, LTETDD
Remote Command	MMEemory:LOAD:EVMSSetup <string>
Example	MMEM:LOAD:EVMS "TM2-BW15MHz.evms"
Notes	Sets of parameters related to EVM Setup are overwritten by the contents of the EVM Setup file.
Initial S/W Revision	A.03.00, A.08.00

Open...

Accesses the standard Windows File Open dialog and the File Open key menu. When you navigate to this selection, you have already determined you are recalling a specific Data Type and now you want to specify which file to open.

When you first enter this dialog, the path in the Look In: field depends on which import data type you selected.

The only files that are visible are those specific to the file type being recalled.

Key Path	Recall, Data
Notes	The key location is mode-dependent and will vary. Brings up Open dialog for recalling a <mode specific> Save Type
Initial S/W Revision	Prior to A.02.00

Open

The import starts by checking for errors. Then the import can start. For all data types, the actual import starts by aborting the currently running measurement. Then the import does data type specific behavior:

File Open Dialog and Menu

The **File Open** is a standard Windows dialog and has a **File Open** key menu. Each key in this menu corresponds to the selectable items in the **File Open** dialog box. The menu keys can be used for easy navigation between the selections within the dialog or the standard **Tab** and **Arrow** keys can be used for dialog navigation. When you navigate to this selection, you have already limited the file recall type and now you want to specify which file to open.

Initial S/W Revision	Prior to A.02.00
----------------------	------------------

Open

This selection and the **Enter** key, when a filename has been selected or specified, cause the load to occur. **Open** loads the specified or selected file to the previously selected recall type of either **State** or a specific import data type.

Notes	Advisory Event "File <file name> recalled" after recall is complete.
Initial S/W Revision	Prior to A.02.00

File/Folder List

This menu key navigates to the center of the dialog that contains the list of files and folders. Once here you can get information about the file.

Key Path	Recall, <various>, Open...
Notes	Pressing this key navigates you to the files and folders list in the center of the dialog.
Initial S/W Revision	Prior to A.02.00

Sort

Accesses a menu that enables you to sort the files within the File Open dialog. Only one sorting type can be selected at a time and the sorting happens immediately.

Key Path	Recall, <various>, Open...
Notes	No SCPI command directly controls the sorting.
Initial S/W Revision	Prior to A.02.00

By Date

Accesses a menu that enables you to sort the list of files within the scope of the File Open dialog in ascending or descending data order. The date is the last data modified.

Key Path	Recall, <various>, Open..., Sort
Notes	Files in the File Open dialog are sorted immediately in the selected order
Initial S/W Revision	Prior to A.02.00

By Name

Accesses a menu that enables you to sort the list of files within the scope of the File Open dialog in ascending or descending order based on the filename.

Key Path	Recall, <various>, Open..., Sort
Notes	Files in the File Open dialog are sorted immediately in the selected order
Initial S/W Revision	Prior to A.02.00

By Extension

Accesses a menu that enables you to sort the list of files within the scope of the File Open dialog in ascending or descending order based on the file extension for each file.

Key Path	Recall, <various>, Open..., Sort
Notes	Files in the File Open dialog are sorted immediately in the selected order

Initial S/W Revision	Prior to A.02.00
----------------------	------------------

By Size

Accesses a menu that enables you to sort the list of files within the scope of the File Open dialog in ascending or descending order based on file size.

Key Path	Recall, <various>, Open..., Sort
Notes	Files in File Open dialog are sorted immediately in the selected order
Initial S/W Revision	Prior to A.02.00

Ascending

This causes the display of the file list to be sorted, according to the sort criteria, in ascending order.

Key Path	Recall, <various>, Open..., Sort
Notes	Files in File Open dialog are sorted immediately in the selected order
Initial S/W Revision	Prior to A.02.00

Descending

This causes the display of the file list to be sorted, according to the sort criteria, in descending order.

Key Path	Recall, <various>, Open..., Sort
Notes	Files in File Open dialog are sorted immediately in the selected order
Initial S/W Revision	Prior to A.02.00

Files Of Type

This menu key corresponds to the Files Of Type selection in the dialog. It follows the standard Windows supported Files Of Type behavior. It shows the current file suffix that corresponds to the type of file the user has selected to save. If you navigated here from recalling State, "State File (*.state)" is in the dialog selection and is the only type available in the pull down menu. If you navigated here from recalling Trace, "Trace+State File (*.trace)" is in the dialog selection and is the only type available under the pull down menu.

If you navigated here from importing a data file, the data types available will be dependent on the current measurement and the selection you made under **Import Data**. For example:

Amplitude Corrections: pull down menu shows

- Amplitude Corrections (*.csv)
- Legacy Cable Corrections (*.cbl)
- Legacy User Corrections (*.amp)
- Legacy Other Corrections (*.oth)

System Functions

Recall

- Legacy Antenna Corrections (*.ant)

Limit: pull down menu shows

- Limit Data (*.csv)
- Legacy Limit Data (*.lim)

Trace: pull down menu shows

- Trace Data (*.csv)

Key Path	Recall, <various>, Open...
Notes	Pressing this key causes the pull down menu to list all possible file types available in this context.
Initial S/W Revision	Prior to A.02.00

Up One Level

This menu key corresponds to the icon of a folder with the up arrow that is in the tool bar of the dialog. It follows the standard Windows supported Up One Level behavior. When pressed, it directs the file and folder list to navigate up one level in the directory structure.

Key Path	Recall, <various>, Open...
Notes	When pressed, the file and folder list is directed up one level of folders and the new list of files and folders is displayed.
Initial S/W Revision	Prior to A.02.00

Cancel

Cancels the current File Open request. It follows the standard Windows supported Cancel behavior.

Key Path	Recall, <various>, Open...
Notes	Pressing this key causes the Open dialog to go away and auto return.
Initial S/W Revision	Prior to A.02.00

Save

Accesses a menu that provides the save type options. The **Save Type** options are **State**, **Trace**, **Data**, or a **Screen Image** depending on the active mode.

Key Path	Front-panel key
Mode	All
Notes	No remote command for this key specifically.
Initial S/W Revision	Prior to A.02.00

State

Selects **State** as the save type and accesses a menu that provides the options of where to save. You can save either to a register or a file. This menu key will not actually cause the save until the location is chosen.

Saving the state is the only way to save this exact measurement context for the current active mode. The entire state of the active mode is saved in a way that when a recall is requested, the mode will return to as close as possible the context in which the save occurred. This includes all settings and data for only the current active mode.

It should be noted that the Input/Output settings will be saved when saving State, since these settings plus the state of the mode best characterize the current context of the mode, but the mode independent System settings will not be saved.

For rapid saving, the State menu lists registers to save to, or you can select a file to save to. Once they select the destination of the save in the State menu, the save will occur.

Key Path	Save
Mode	All
Example	MMEM:STOR:STATE "MyStateFile.state" This stores the current instrument state data in the file MyStateFile.state in the default directory.
Notes	See “Save” on page 213 .
Initial S/W Revision	Prior to A.02.00

Register 1 thru Register 6

Selecting any one of these register menu keys causes the State of the currently active mode to be saved to the specified Register. The registers are provided for rapid saving and recalling, since you do not need to specify a filename or navigate to a file. Each of the register menu keys annotates whether it is empty or at what date and time it was last modified.

These 6 registers are all that is available from the front panel for all modes in the instrument. There are not 6 registers available for each mode. From remote, 127 Registers are available. Registers are files that

System Functions
Save

are visible to the user in the My Documents\System folder.

Key Path	Save, State
Mode	All
Example	*SAV 1
Readback	Date and time with seconds resolution are displayed on the key, or "(empty)" if no prior save operation performed to this register.
Initial S/W Revision	Prior to A.02.00

Key Path	Save, State
Mode	All
Example	*SAV 2
Readback	Date and time with seconds resolution are displayed on the key, or "(empty)" if no prior save operation performed to this register.
Initial S/W Revision	Prior to A.02.00

Key Path	Save, State
Mode	All
Example	*SAV 3
Readback	Date and time with seconds resolution are displayed on the key, or "(empty)" if no prior save operation performed to this register.
Initial S/W Revision	Prior to A.02.00

Key Path	Save, State
Mode	All
Example	*SAV 4
Readback	Date and time with seconds resolution are displayed on the key, or "(empty)" if no prior save operation performed to this register.
Initial S/W Revision	Prior to A.02.00

Key Path	Save, State
Mode	All
Example	*SAV 5
Readback	Date and time with seconds resolution are displayed on the key, or "(empty)" if no prior save operation performed to this register.
Initial S/W Revision	Prior to A.02.00

Key Path	Save, State
Mode	All
Example	*SAV 6
Readback	Date and time with seconds resolution are displayed on the key, or "(empty)" if no prior save operation performed to this register.
Initial S/W Revision	Prior to A.02.00

To File . . .

Accesses a menu that enables you to select the location for saving the State. This menu is similar to a standard Windows® **Save As** dialog.

The default path for all State Files is:

My Documents\<<mode name>\state

where <mode name> is the parameter used to select the mode with the INST:SEL command (for example, SA for the Spectrum Analyzer). This path is the **Save In:** path in the **Save As** dialog for all State Files when they first enter this dialog.

Key Path	Save, State
Mode	All
Notes	Brings up Save As dialog for saving a State Save Type
Initial S/W Revision	Prior to A.02.00

Save As . . .

Accesses a menu that enables you to select the location where you can save the State. This menu is a standard Windows® dialog with Save As menu keys. The "File Name" field in the Save As dialog is initially loaded with an automatically generated filename specific to the appropriate Save Type. The automatically generated filename is guaranteed not to conflict with any filename currently in the directory. You may replace or modify this filename using the File Name softkey. See the Quick Save key documentation for more on the automatic file naming algorithm.

The default path for all State Files is:

My Documents\<<mode name>\state

where <mode name> is the parameter used to select the mode with the INST:SEL command (for example, SA for the Spectrum Analyzer).

When you first enter this dialog, the path in the **Save In:** field depends on the data type. The only files that are visible are the *.state files and the Save As type is *.state, since .state is the file suffix for the State Save Type.

Key Path	Save, State
Mode	All

System Functions
Save

Notes	Brings up Save As dialog for saving a State Save Type
Initial S/W Revision	Prior to A.02.00

Save

Saves all of the State of the currently active mode plus the system level Input/Output settings to the specified file.

While the save is being performed, the floppy icon shows up in the settings bar near the Continuous/Single sweep icon. After the save completes, the Advisory Event "File <register number> saved" is displayed.

Key Path	Save, State, To File...
Mode	All
Remote Command	:MMEMory:STORe:STATe <filename>
Example	:MMEM:STOR:STAT "myState.state" saves the file myState.state on the default path
Notes	If the file already exists, the file will be overwritten. Both single and double quotes are supported for any filename parameter over remote. Using the C: drive is not encouraged, it is best to use My Documents on the D: drive. Auto return to the State menu and the Save As dialog goes away.
Backwards Compatibility SCPI	:MMEMory:STORe:STATe 1,<filename> For backwards compatibility, the above syntax is supported. The "1" is simply ignored. The command is sequential.
Initial S/W Revision	Prior to A.02.00

Trace (+State)

Selects a state file which includes trace data for recalling as the save type and accesses a menu that enables you to select which trace to save. You can save to either a register or a file. Not all modes support saving trace data with the state, and for modes that do, not all measurements do. This key is grayed out for measurements that do not support trace saves. It is blanked for modes that do not support trace saves. Saving **Trace** is identical to saving State except a .trace extension is used on the file instead of .state, and internal flags are set in the file indicating which trace was saved. You may also select to save ALL traces.

This key will not actually cause the save, since the save feature still needs to know which trace to save and where to save it. Pressing this key accesses the Save Trace menu that provides the user with these options.

For rapid saving, the Trace menu lists registers to save to, or you can select a file to save to. Once you pick the destination of the save in the Trace menu, the save will occur.

Key Path	Save
----------	-------------

Mode	SA
Example	MMEM:STOR:STATe TRACE2,"MyTraceFile.trace" This stores trace 2 data in the file MyTraceFile.trace in the default directory. :MMEM:STOR:TRAC:REG TRACE1,2 stores trace 1 data in trace register 2 :MMEM:STOR:TRAC:REG ALL,3 saves the data for all 6 traces in trace register 3
Notes	See "Save" on page 213.
Initial S/W Revision	Prior to A.02.00

Register 1 thru Register 5

Selecting any one of these register menu keys causes the Trace(s) specified under From Trace, along with the state of the currently active mode, to be saved to the specified Trace Register. The registers are provided for rapid saving and recalling, since you do not need to specify a filename or navigate to a file. Each of the register menu keys annotates whether it is empty or at what date and time it was last modified.

These 5 trace registers are all that is available for all modes in the instrument. At present, only the Swept SA measurement of the Spectrum Analyzer mode supports saving to Trace+State files. Registers are files that are visible to the user in the My Documents\System folder.

Key Path	Save, Trace
Mode	SA
Readback	Date and time with seconds resolution are displayed on the key, or "(empty)" if no prior save operation performed to this register.
Initial S/W Revision	Prior to A.02.00

Key Path	Save, Trace
Mode	SA
Readback	Date and time with seconds resolution are displayed on the key, or "(empty)" if no prior save operation performed to this register.
Initial S/W Revision	Prior to A.02.00

Key Path	Save, Trace
Mode	SA
Readback	Date and time with seconds resolution are displayed on the key, or "(empty)" if no prior save operation performed to this register.
Initial S/W Revision	Prior to A.02.00

Key Path	Save, Trace
----------	--------------------

System Functions
Save

Mode	SA
Readback	Date and time with seconds resolution are displayed on the key, or "(empty)" if no prior save operation performed to this register.
Initial S/W Revision	Prior to A.02.00

Key Path	Save, Trace
Mode	SA
Readback	Date and time with seconds resolution are displayed on the key, or "(empty)" if no prior save operation performed to this register.
Initial S/W Revision	Prior to A.02.00

From Trace

Accesses a menu that enables you to select the trace to be saved. Once a trace is selected, the key returns to the Save Trace menu and the selected trace number is annotated on the key. The default is the currently selected trace, selected in this menu or in the Trace/Det, Export Data, Import Data or Recall Trace menus, except if you have chosen All then it remains chosen until you specifically change it to a single trace. To save the Trace you must select the **Save As** key in the Save Trace menu.

Key Path	Save, Trace + State
Mode	SA
Initial S/W Revision	Prior to A.02.00

Save As . . .

This menu lets you select the location where you can save the Trace. It is a standard Windows® dialog with Save As menu keys.

The "File Name" field in the Save As dialog is initially loaded with an automatically generated filename specific to the appropriate Save Type. The automatically generated filename is guaranteed not to conflict with any filename currently in the directory. You may replace or modify this filename using the File Name key. See the Quick Save key documentation for more on the automatic file naming algorithm.

The default path for all State Files including .trace files is:

My Documents\<<mode name>\state

where <mode name> is the parameter used to select the mode with the INST:SEL command (for example, SA for the Spectrum Analyzer).

When you first enter this dialog, the path in the Save In: field depends on the data type. The only files that are visible are the *.trace files and the Save As type is *.trace, since .trace is the file suffix for the Trace Save Type.

Key Path	Save, Trace (+State)
Mode	SA

Notes	Brings up the Save As dialog for saving a Trace Save Type
Initial S/W Revision	Prior to A.02.00

Save

This key initiates the save of the .trace file. All of the State of the currently active mode plus the system level Input/Output settings are saved to the specified file as well as all of the trace data, including internal flags set in the file indicating which trace is to be saved.

While the save is being performed, the floppy icon shows up in the settings bar near the Continuous/Single sweep icon. After the save completes, the Advisory Event "File <register number> saved" is displayed.

Key Path	Save, Trace, Save As...
Mode	SA
Remote Command	:MMEMory:STORe:TRACe TRACE1 TRACE2 TRACE3 TRACE4 TRACE5 TRACE6 ALL, <filename > : :MMEMory:STORe:TRACe:REGister TRACE1 TRACE2 TRACE3 TRACE4 TRACE5 TRACE6 ALL, <integer>
Example	:MMEM:STOR:TRAC TRACE1, "myState.trace" saves the file myState.trace on the default path and flags it as a "single trace" file with Trace 1 as the single trace (even though all of the traces are in fact stored). :MMEM:STOR:TRAC ALL, "myState.trace" saves the file myState.trace on the default path and flags it as an "all traces" file :MMEM:STOR:TRAC:REG TRACE1,2 stores trace 1 data in trace register 2
Notes	Some modes and measurements do not have available all 6 traces. The Phase Noise mode command, for example, is: MMEMory:STORe:TRACe TRACE1 TRACE2 TRACE3 ALL,<filename> This command actually performs a save state, which in the Swept SA measurement includes the trace data. However it flags it (in the file) as a "save trace" file of the specified trace (or all traces). The range for the register parameter is 1–5 If the file already exists, the file will be overwritten. Using the C: drive is strongly discouraged, since it runs the risk of being overwritten during an instrument software upgrade. Both single and double quotes are supported for any filename parameter over remote. Auto return to the State menu and the Save As dialog goes away.
Initial S/W Revision	Prior to A.02.00

Data (Export)

Exporting a data file stores data from the current measurement to mass storage files. The Export Menu only contains data types that are supported by the current measurement.

System Functions

Save

Since the commonly exported data files are in .csv format, the data can be edited by you prior to importing. This allows you to export a data file, manipulate the data in Excel (the most common PC Application for manipulating .csv files) and then import it.

Selecting an Export Data menu key will not actually cause the exporting to occur, since the analyzer still needs to know where you wish to save the data. Pressing the Save As key in this menu brings up the Save As dialog and Save As menu that allows you to specify the destination file and directory. Once a filename has been selected or entered in the Open menu, the export will occur as soon as the Save key is pressed.

Key Path	Save
Mode	All
Notes	The menu is built from whatever data types are available for the mode. So the key locations in the sub menu will vary. No SCPI command directly controls the Data Type that this key controls. The Data Type is included in the MMEM:STORe commands.
Dependencies	If a file type is not used by a certain measurement, that type is grayed out for that measurement. The key for a file type will not show at all if there are no measurements in the Mode that support it.
Preset	Is not affected by a Preset or shutdown, but is reset during Restore Mode Defaults
Readback	The data type that is currently selected
Initial S/W Revision	Prior to A.02.00

Save As . . .

This menu lets you select the location where you can save Data Type files. It is a standard Windows® dialog with Save As menu keys. The "File Name" field in the Save As dialog is initially loaded with an automatically generated filename specific to the appropriate Save Type. The automatically generated filename is guaranteed not to conflict with any filename currently in the directory. You may replace or modify this filename using the File Name key. See the Quick Save key documentation for more on the automatic file naming algorithm.

When you first enter this dialog, the path in the Save In: field depends on the data type. The only files that are visible are the files with the corresponding data type suffix, and the **Save As** type lists the same suffix.

For example, if the Data Type is **Amplitude Corrections**, the file suffix is .csv and the *.csv files are the only visible files in the **Save As** dialog and .csv is the Save As Type.

The default path for saving files is:

For all of the Trace Data Files:

My Documents\<<mode name>\data\traces

For all of the Limit Data Files:

My Documents\<<mode name>\data\limits

For all of the Measurement Results Data Files:

My Documents\<<mode name>\data\<<measurement name>\results

For all of the Capture Buffer Data Files:

My Documents\<<mode name>\data\captureBuffer

Key Path	Save, Data
Mode	All
Notes	The key location is mode-dependent and will vary. Brings up the Save As dialog for saving a <mode specific> Save Type
Initial S/W Revision	Prior to A.02.00

Save

Saves the specified Data Type. This section describes any specific save behavior relevant to Data that is common to all modes.

When a Save of a specific Data File is requested, the specified data is saved to the specified or selected file. The save is performed immediately and does not wait until the measurement is complete.

If the file already exists, a dialog will appear that allows you to replace the existing file by selecting **OK** or you can Cancel the request.

While the save is being performed, the floppy icon will show up in the settings bar near the Continuous/Single icon. After a register save completes, the corresponding register softkey annotation is updated with the date the time and an advisory message that the file was saved appears in the message bar.

Key Path	Save, Data, Save As...
Notes	If the file already exists, the file will be overwritten. Using the C: drive is strongly discouraged, since it runs the risk of being overwritten during an instrument software upgrade. Both single and double quotes are supported for any filename parameter over remote.
Initial S/W Revision	Prior to A.02.00

Screen Image

Accesses a menu of functions that enable you to specify a format and location for the saved screen image.

Pressing Screen Image brings up a menu that allows you to specify the color scheme of the Screen Image (Themes) or navigate to the Save As dialog to perform the actual save.

Screen Image files contain an exact representation of the analyzer display. They cannot be loaded back onto the analyzer, but they can be loaded into your PC for use in many popular applications.

The image to be saved is actually captured when the **Save** front panel key is pressed, and kept in temporary storage to be used if you ask for a Screen Image save. When the Screen Image key is pressed,

System Functions
Save

a "thumbnail" of the captured image is displayed, as shown below:

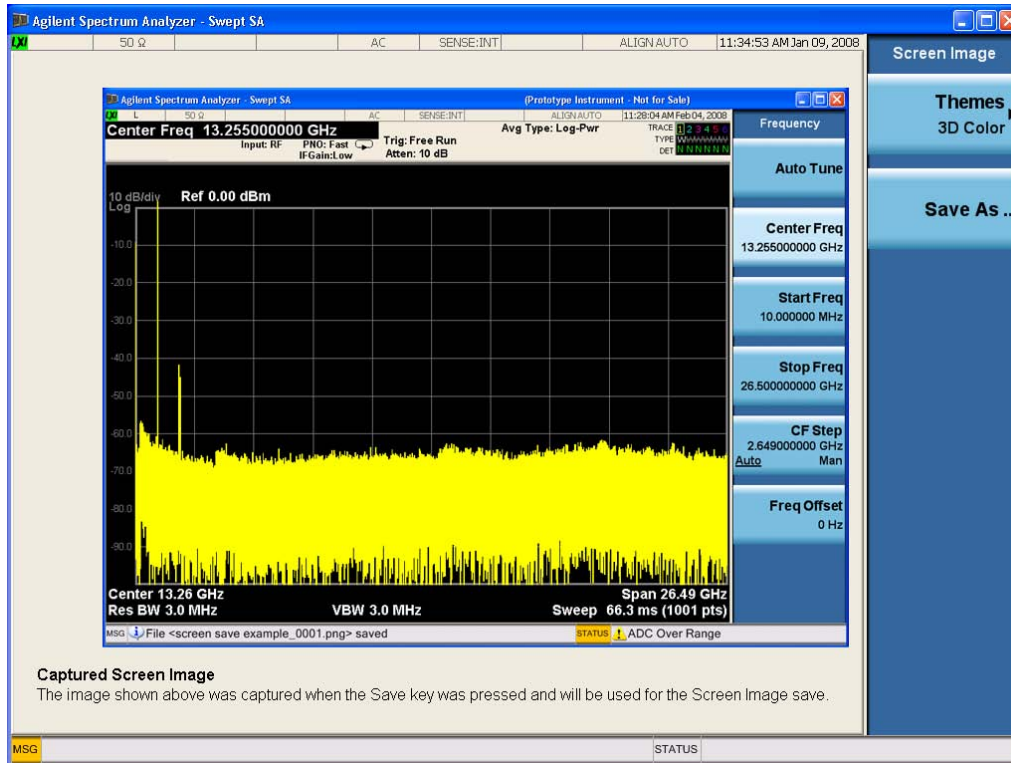

When you continue on into the **Save As** menu and complete the Screen Image save, the image depicted in the thumbnail is the one that gets saved, showing the menus that were on the screen before going into the **Save** menus.

After you have completed the save, the **Quick Save** front-panel key lets you quickly repeat the last save performed, using an auto-named file, with the current screen data.

NOTE For versions previous to A.01.55, if you initiate a screen image save by navigating through the Save menus, the image that is saved will contain the Save menu softkeys, not the menus and the active function that were on the screen when you first pressed the Save front panel key.

Key Path	Save
Mode	All
Example	MMEM:STOR:SCR "MyScreenFile.png" This stores the current screen image in the file MyScreenFile.png in the default directory.
Notes	See
Initial S/W Revision	Prior to A.02.00

Themes

Accesses a menu of functions that enable you to choose the theme to be used when saving the screen image.

The **Themes** option is the same as the **Themes** option under the **Display** and **Page Setup** dialogs. It allows you to choose between themes to be used when saving the screen image.

Key Path	Save, Screen Image
Remote Command	:MMEMory:STORe:SCReem:THEME TDCoLor TDMonochrome FCoLoR FMONochrome :MMEMory:STORe:SCReem:THEMe?
Example	:MMEM:STOR:SCR:THEM TDM
Preset	3D Color; Is not part of Preset, but is reset by Restore Misc Defaults or Restore System Defaults All and survives subsequent running of the modes.
Readback	3D Color 3D Mono Flat Color Flat Mono
Backwards Compatibility Notes	In ESA and PSA we offer the choice of "Reverse Bitmap" or "Reverse Metafile" when saving screen images. This is much like the "Flat Color" theme available in X-Series. Also, if the user selected Reverse Bitmap AND a black&white screen image, that would be much like "Flat Monochrome". In other words, each of the X-Series themes has a similar screen image type in ESA/PSA. But they are not identical.
Initial S/W Revision	Prior to A.02.00

3D Color

Selects a standard color theme with each object filled, shaded and colored as designed.

Key Path	Save, Screen Image, Themes
Example	MMEM:STOR:SCR:THEM TDC
Readback	3D Color
Initial S/W Revision	Prior to A.02.00

3D Monochrome

Selects a format that is like 3D color but shades of gray are used instead of colors.

Key Path	Save, Screen Image, Themes
Example	MMEM:STOR:SCR:THEM TDM
Readback	3D Mono
Initial S/W Revision	Prior to A.02.00

Flat Color

Selects a format that is best when the screen is to be printed on an ink printer.

Key Path	Save, Screen Image, Themes
Example	MMEM:STOR:SCR:THEM FCOL
Readback	Flat Color
Initial S/W Revision	Prior to A.02.00

Flat Monochrome

Selects a format that is like Flat Color. But only black is used (no colors, not even gray), and no fill.

Key Path	Save, Screen Image, Themes
Example	MMEM:STOR:SCR:THEM FMON
Readback	Flat Mono
Initial S/W Revision	Prior to A.02.00

Save As...

Accesses a menu that enables you to select the location where you can save the Screen Image. This menu is a standard Windows® dialog with Save As menu keys. The **Save As** dialog is loaded with the file information related to the Screen Image Type. The filename is filled in using the auto file naming algorithm for the Screen Image Type and is highlighted. The only files that are visible are the *.png files and the Save As Type is *.png, since .png is the file suffix for the Screen Image Type.

The default path for Screen Images is

My Documents\`<mode name>`\screen.

where `<mode name>` is the parameter used to select the mode with the INST:SEL command (for example, SA for the Spectrum Analyzer).

This path is the **Save In:** path in the **Save As** dialog for all Screen Files when you first enter this dialog.

Key Path	Save, Screen Image
Notes	Brings up Save As dialog for saving a Screen Image Save Type
Initial S/W Revision	Prior to A.02.00

Save

Saves the screen image to the specified file using the selected theme. The image that is saved is the measurement display prior to when the **Save As** dialog appeared. The save is performed immediately and does not wait until the measurement is complete.

Key Path	Save, Screen Image, Save As...
----------	---------------------------------------

Remote Command	:MMEMory:STORe:SCReen <filename>
Example	:MMEM:STOR:SCR "myScreen.png"
Notes	<p>If the file already exists, the file will be overwritten. Using the C: drive is strongly discouraged, since it runs the risk of being overwritten during an instrument software upgrade. Both single and double quotes are supported for any filename parameter over remote.</p> <p>Auto return to the Screen Image menu and the Save As dialog goes away.</p> <p>Advisory Event "File <file name> saved" after save is complete.</p>
Initial S/W Revision	Prior to A.02.00

Save As . . .

Accesses a standard Windows dialog with the **Save As** key menu. The "File Name" field in the Save As dialog is initially loaded with an automatically generated filename specific to the appropriate Save Type. The automatically generated filename is guaranteed not to conflict with any filename currently in the directory. You may replace or modify this filename using the File Name key. See the Quick Save key documentation for more on the automatic file naming algorithm.

The **Save As** dialog has the last path loaded in **Save In:** for this particular file type. User specified paths are remembered and persist through subsequent runs of the mode. These remembered paths are mode specific and are reset back to the default using **Restore Mode Defaults**.

Initial S/W Revision	Prior to A.02.00
----------------------	------------------

Save

Performs the actual save to the specified file of the selected type. The act of saving does not affect the currently running measurement and does not require you to be in single measurement mode to request a save. It performs the save as soon as the currently running measurement is in the idle state; when the measurement completes. This ensures the State or Data that is saved includes complete data for the current settings. The save only waits for the measurement to complete when the state or data that depends on the measurement setup is being saved. The save happens immediately when exporting corrections or when saving a screen image.

If the file already exists, a dialog appears with corresponding menu keys that allow you to replace the existing file with an **OK** or to **Cancel** the request.

While the save is being performed, the floppy icon shows up in the settings bar near the Continuous/Single icon. After the save completes, the corresponding register menu key annotation is updated with the date the time and the message "File <file name> saved" appears in the message bar.

Notes	<p>If the file already exists, the File Exist dialog appears and allows you to replace it or not by selecting the Yes or No menu keys that appear with the dialog. Then the key causes an auto return and Save As dialog goes away.</p> <p>Advisory Event "File <file name> saved" after save is complete.</p>
Initial S/W Revision	Prior to A.02.00

File/Folder List

Enables you to navigate to the center of the dialog that contains the list of files and folders. Once here you can get information about the file.

Key Path	Save, <various>, Save As...
Notes	Pressing this key enables you to navigate to the files and folders list in the center of the dialog.
Initial S/W Revision	Prior to A.02.00

File Name

Accesses the Alpha Editor. Use the knob to choose the letter to add and the Enter front-panel key to add the letter to the file name. In addition to the list of alpha characters, this editor includes a **Space** key and a **Done** key. The **Done** key completes the filename, removes the Alpha Editor and returns back to the **File Open** dialog and menu, but does not cause the save to occur. You can also use **Enter** to complete the file name entry and this will cause the save to occur.

Key Path	Save, <various>, Save As...
Notes	Brings up the Alpha Editor. Editor created file name is loaded in the File name field of the Save As dialog.
Initial S/W Revision	Prior to A.02.00

Save As Type

This key corresponds to the **Save As Type** selection in the dialog. It follows the standard Windows® supported **Save As Type** behavior. It shows the current file suffix that corresponds to the type of file you have selected to save. If you navigated here from saving State, "State File (*.state)" is in the dialog selection and is the only type available under the pull down menu. If you navigated here from saving Trace, "Trace+State File (*.trace)" is in the dialog selection and is the only type available under the pull down menu. If you navigated here from exporting a data file, "Data File (*.csv)" is in the dialog and is available in the pull down menu. Modes can have other data file types and they would also be listed in the pull down menu.

Key Path	Save, <various>, Save As...
Notes	Pressing this key causes the pull down menu to list all possible file types available in this context. All types available are loaded in a 1-of-N menu key for easy navigation.
Initial S/W Revision	Prior to A.02.00

Up One Level

This key corresponds to the icon of a folder with the up arrow that is in the tool bar of the dialog. It follows the standard Windows® supported **Up One Level** behavior. When pressed, it causes the file and

folder list to navigate up one level in the directory structure.

Key Path	Save, <various>, Save As...
Notes	When pressed, the file and folder list is directed up one level of folders and the new list of files and folders is displayed
Initial S/W Revision	Prior to A.02.00

Create New Folder

This key corresponds to the icon of a folder with the "*" that is in the tool bar of the dialog. It follows the standard Windows® supported **Create New Folder** behavior. When pressed, a new folder is created in the current directory with the name **New Folder** and allows you to enter a new folder name using the Alpha Editor.

Key Path	Save, <various>, Save As...
Notes	Creates a new folder in the current folder and lets the user fill in the folder name using the Alpha Editor.
Initial S/W Revision	Prior to A.02.00

Cancel

This key corresponds to the **Cancel** selection in the dialog. It follows the standard Windows supported **Cancel** behavior. It causes the current **Save As** request to be cancelled.

Key Path	Save, <various>, Save As...
Notes	Pressing this key causes the Save As dialog to go away and auto return.
Initial S/W Revision	Prior to A.02.00

Mass Storage Catalog (Remote Command Only)

Remote Command	:MMEMory:CATalog? [<directory_name>]
Notes	<p>The string must be a valid logical path.</p> <p>Query disk usage information (drive capacity, free space available) and obtain a list of files and directories in a specified directory in the following format:</p> <p><numeric_value>,<numeric_value>,{<file_entry>}</p> <p>It shall return two numeric parameters and as many strings as there are files and directories. The first parameter shall indicate the total amount of storage currently used in bytes. The second parameter shall indicate the total amount of storage available, also in bytes. The <file_entry> is a string. Each <file_entry> shall indicate the name, type, and size of one file in the directory list:</p> <p><file_name>,<file_type>,<file_size></p> <p>As windows file system has an extension that indicates file type, <file_type> is always empty. <file_size> provides the size of the file in bytes. In case of directories, <file_entry> is surrounded by square brackets and both <file_type> and <file_size> are empty.</p>
Initial S/W Revision	Prior to A.02.00

Mass Storage Change Directory (Remote Command Only)

Remote Command	:MMEMory:CDIRectory [<directory_name>] :MMEMory:CDIRectory?
Notes	<p>The string must be a valid logical path.</p> <p>Changes the default directory for a mass memory file system. The <directory_name> parameter is a string. If no parameter is specified, the directory is set to the *RST value.</p> <p>At *RST, this value is set to the default user data storage area, that is defined as System.Environment.SpecialFolder.Personal.</p> <p>Query returns full path of the default directory.</p>
Initial S/W Revision	Prior to A.02.00

Mass Storage Copy (Remote Command Only)

Remote Command	:MMEMory:COPY <string>,<string>[,<string>,<string>]
-----------------------	---

Notes	<p>The string must be a valid logical path.</p> <p>Copies an existing file to a new file or an existing directory to a new directory.</p> <p>Two forms of parameters are allowed. The first form has two parameters. In this form, the first parameter specifies the source, and the second parameter specifies the destination.</p> <p>The second form has four parameters. In this form, the first and third parameters specify the source. The second and fourth parameters specify the directories. The first pair of parameters specifies the source. The second pair specifies the destination. An error is generated if the source doesn't exist or the destination file already exists.</p>
-------	---

Mass Storage Delete (Remote Command Only)

Remote Command	:MMEMory:DELeTe <file_name>[, <directory_name>]
Notes	<p>The string must be a valid logical path.</p> <p>Removes a file from the specified directory. The <file_name> parameter specifies the file name to be removed.</p>
Initial S/W Revision	Prior to A.02.00

Mass Storage Data (Remote Command Only)

Creates a file containing the specified data OR queries the data from an existing file.

Remote Command	<p>:MMEMory:DATA <file_name>, <data></p> <p>:MMEMory:DATA? <file_name></p>
Notes	<p>The string must be a valid logical path.</p> <p>The command form is MMEMory:DATA <file_name>,<data>. It loads <data> into the file <file_name>. <data> is in 488.2 block format. <file_name> is string data.</p> <p>The query form is MMEMory:DATA? <file_name> with the response being the associated <data> in block format.</p>
Initial S/W Revision	Prior to A.02.00

Mass Storage Make Directory (Remote Command Only)

Remote Command	:MMEMory:MDIRectory <directory_name>
Notes	The string must be a valid logical path. Creates a new directory. The <directory_name> parameter specifies the name to be created.
Initial S/W Revision	Prior to A.02.00

Mass Storage Move (Remote Command Only)

Remote Command	:MMEMory:MOVE <string>,<string>[,<string>,<string>]
Notes	The string must be a valid logical path. Moves an existing file to a new file or an existing directory to a new directory. Two forms of parameters are allowed. The first form has two parameters. In this form, the first parameter specifies the source, and the second parameter specifies the destination. The second form has four parameters. In this form, the first and third parameters specify the source. The second and fourth parameters specify the directories. The first pair of parameters specifies the source. The second pair specifies the destination. An error is generated if the source doesn't exist or the destination file already exists.
Initial S/W Revision	Prior to A.02.00

Mass Storage Remove Directory (Remote Command Only)

Remote Command	:MEMMory:RDIRectory <directory_name>
Notes	The string must be a valid logical path. Removes a directory. The <directory_name> parameter specifies the directory name to be removed. All files and directories under the specified directory shall also be removed.
Initial S/W Revision	Prior to A.02.00

System

Opens a menu of keys that access various configuration menus and dialogs.

Key Path	Front-panel key
Notes	No remote command for this key specifically.
Initial S/W Revision	Prior to A.02.00

Show

Accesses a menu of choices that enable you to select the information window you want to view.

Key Path	System
Mode	All
Remote Command	:SYSTem:SHOW OFF ERRor SYSTem HARDware LXI HWSTatistics ALIGNment SOFTware CAPPLication :SYSTem:SHOW?
Example	:SYST:SHOW SYST
Notes	This command displays (or exits) the various System information screens.
Preset	OFF
State Saved	No
Range	OFF ERRor SYSTem HARDware LXI HWSTatistics ALIGNment SOFTware CAPPLication
Initial S/W Revision	Prior to A.02.00

Errors

There are two modes for the Errors selection, History and Status.

The list of errors displayed in the Errors screen does not automatically refresh. You must press the Refresh key or leave the screen and return to it to refresh it.

History brings up a screen displaying the event log in chronological order, with the newest event at the top. The history queue can hold up to 100 messages (if a message has a repeat count greater than 1 it only counts once against this number of 100). Note that this count bears no relation to the size of the SCPI queue. If the queue extends onto a second page, a scroll bar appears to allow scrolling with a mouse. Time is displayed to the second.

Status brings up a screen summarizing the status conditions currently in effect. Note that the time is displayed to the second.

The fields on the Errors display are:

System Functions
System

Type (unlabelled) - Displays the icon identifying the event or condition as an error or warning.

ID - Displays the error number.

Message - Displays the message text.

Repeat (RPT) - This field shows the number of consecutive instances of the event, uninterrupted by other events. In other words, if an event occurs 5 times with no other intervening event, the value of repeat will be 5.

If the value of Repeat is 1 the field does not display. If the value of Repeat is >1, the time and date shown are those of the most recent occurrence. If the value of repeat reaches 999,999 it stops there.

Time - Shows the most recent time (including the date) at which the event occurred.

Key Path	System, Show
Mode	All
Remote Command	:SYSTem:ERRor[:NEXT]?
Example	:SYST:ERR?
Notes	<p>The return string has the format:</p> <p>“<Error Number>,<Error>”</p> <p>Where <Error Number> and <Error> are those shown on the Show Errors screen</p>
Backwards Compatibility Notes	<p>In some legacy analyzers, the Repeat field shows the number of times the message has repeated since the last time the error queue was cleared. In the X-Series, the Repeat field shows the number of times the error has repeated since the last intervening error. So the count may very well be different than in the past even for identical signal conditions</p> <p>Unlike previous analyzers, in the X-Series all errors are reported through the Message or Status lines and are logged to the event queue. They never appear as text in the graticule area (as they sometimes do in previous analyzers) and they are never displayed in the settings panel at the top of the screen (as they sometimes do, by changing color, in previous analyzers).</p> <p>As a consequence of the above, the user can only see one status condition (the most recently generated) without looking at the queue. In the past, at least in the Spectrum Analyzer, multiple status conditions might display on the right side of the graticule.</p> <p>In general there is no backwards compatibility specified or guaranteed between the error numbers in the X-Series and those of earlier products. Error, event, and status processing code in customers’ software will probably need to be rewritten to work with X-Series.</p> <p>In the legacy analyzers, some conditions report as errors and others simply turn on status bits. Conditions that report as errors often report over and over as long as the condition exists. In the X-series, all conditions report as start and stop events. Consequently, software that repeatedly queries for a condition error until it stops reporting will have to be rewritten for the X-series.</p>

Initial S/W Revision	Prior to A.02.00
----------------------	------------------

Next Page

Next Page and Previous Page menu keys move you between pages of the log, if it fills more than one page. These keys are grayed out in some cases:

- If on the last page of the log, the Next Page key is grayed out
- If on the first page of the log, the Previous Page key is grayed out.
- If there is only one page, both keys are grayed out.

Key Path	System, Show, Errors
Initial S/W Revision	Prior to A.02.00

Previous Page

See .

Key Path	System, Show, Errors
Initial S/W Revision	Prior to A.02.00

History

The History and Status keys select the Errors view. The Status key has a second line which shows a number in [square brackets]. This is the number of currently open status items.

Key Path	System, Show, Errors
Initial S/W Revision	Prior to A.02.00

Status

See [“History” on page 227](#).

Verbose SCPI On/Off

This is a capability that will allow the SCPI data stream to be displayed when a SCPI error is detected, showing the characters which stimulated the error and several of the characters preceding the error.

Key Path	System, Show, Errors
Mode	All
Remote Command	:SYSTem:ERRor:VERBoSe OFF ON 0 1 :SYSTem:ERRor:VERBoSe?
Example	:SYST:ERR:VERB ON
Preset	This is unaffected by Preset but is set to OFF on a “Restore System Defaults->Misc”

State Saved	No
Range	On Off
Initial S/W Revision	Prior to A.02.00

Input Overload Enable (Remote Command Only)

Input Overload errors are reported using the Input Overload status bit (bit 12 in the Measurement Integrity status register). Input Overloads (for example, ADC Overload errors) can come and go with great frequency, generating many error events (for example, for signals just on the verge of overload), and so are not put into the SCPI error queue by default. Normally the status bit is the only way for detecting these errors remotely.

It is possible to enable Input Overload reporting to the SCPI queue, by issuing the :SYSTEM:ERROR:OVERload ON command. To return to the default state, issue the :SYSTEM:ERROR:OVERload OFF command. In either case, Input Overloads always set the status bit.

NOTE For versions of firmware before A.10.01, the Input Overload was only a Warning and so was never available in the SCPI queue, although it did set the status bit. For A.10.01 and later, the Input Overload is an error and can be enabled to the SCPI queue using this command.

Key Path	SCPI only
Remote Command	:SYSTEM:ERROR:OVERload[:STATE] 0 1 OFF ON
Example	:SYST:ERR:OVER 1 Enable overload errors
Preset	Set to OFF by Restore Misc Defaults (no Overload errors go to SCPI)
State Saved	Saved in State
Initial S/W Revision	A.10.01

Refresh

When pressed, refreshes the Show Errors display.

Key Path	System, Show, Errors
Initial S/W Revision	Prior to A.02.00

Clear Error Queue

This clears all errors in all error queues.

Note the following:

Clear Error Queue does not affect the current status conditions.

Mode Preset does not clear the error queue.

Restore System Defaults will clear all error queues.

*CLS only clears the queue if it is sent remotely and *RST does not affect any error queue.

Switching modes does not affect any error queues.

Key Path	System, Show, Errors
Initial S/W Revision	Prior to A.02.00

System

The System screen is formatted into three groupings: product descriptive information, options tied to the hardware, and software products:

<Product Name> <Product Description>	
Product Number: N9020A	
Serial Number: US46220924	
Firmware Revision: A.01.01	
Computer Name: <hostname>	
Host ID: N9020A,US44220924	
N9020A-503	Frequency Range to 3.6 GHz
N9020A-PFR	Precision Frequency Reference
N9020A-P03	Preamp 3.6 GHz
N9060A-2FP	Spectrum Analysis Measurement Suite 1.0.0.0
N9073A-1FP	WCDMA 1.0.0.0
N9073A-2FP	WCDMA with HSDPA 1.0.0.0

The Previous Page is grayed-out if the first page of information is presently displayed. The Next Page menu key is grayed-out if the last page is information is presently displayed.

Key Path	System, Show
Mode	All
Example	SYST:SHOW SYST
Backwards Compatibility Notes	The hardware statistics that are displayed in the PSA Show System screen have been moved to a dedicated Show Hardware Statistics screen in the Service Menu.
Initial S/W Revision	Prior to A.02.00

Show System contents (Remote Command Only)

A remote command is available to obtain the contents of the Show System screen (the entire contents,

Example	SYST:SHOW HARD
Initial S/W Revision	Prior to A.02.00

LXI

This key shows you the product number, serial number, firmware revision, computer name, IP address, Host ID, LXI Class, LXI Version, MAC Address, and the Auto-MDIX Capability.

Key Path	System, Show
Initial S/W Revision	Prior to A.02.00

LXI Event Log

The event log records all of the LXI LAN event activity. As LXI LAN events are sent or received, the activity is noted in the Event Log with an IEEE 1588 timestamp. When the event log is selected, the current contents of the event log are displayed in the system information screen.

The fields recorded in the Event Log are:

- The date the event occurred (GMT)
- The time the event occurred (GMT)
- The type of event: LAN Input, LAN Output, Status, Alarm, Trigger Alarm, Trigger LAN
- The name of the event
- The edge associated with the event
- The event's identifier: This is the string that appears on the LAN.
- The source event: This is only valid for LAN Output, Trigger LAN, and Trigger Alarm event types.
- The source address: This is only valid for LAN Input event types. It is the address from which the message originated.
- The destination address: This is only valid for LAN Output event types. It is the address (or addresses) that the message will be sent to. For UDP messages, this field reads "ALL."

Key Path	System, Show, LXI
Initial S/W Revision	Prior to A.02.00

Next Page

See .

Key Path	System, Show, Errors
Initial S/W Revision	Prior to A.02.00

Previous Page

See

Key Path	System, Show, Errors
Initial S/W Revision	Prior to A.02.00

Circular

Sets the behavior for entries that occur while the LXI Event Log is full.

- If Circular is set to 1, incoming events overwrite the oldest events in the log.
- If Circular is set to 0, incoming events are discarded.

Key Path	System, Show, LXI, LXI Event Log
Remote Command	:LXI:EVENT:LOG:CIRCular[:ENABLE] ON OFF 1 0 :LXI:EVENT:LOG:CIRCular[:ENABLE]?
Example	:LXI:EVEN:LOG:CIRC 1
Preset	Not affected by a Preset. The default value of "ON" can be restored by pressing System, Restore Defaults, Misc.
State Saved	Saved in instrument state.
Range	OFF ON 0 1
Initial S/W Revision	Prior to A.02.00

Clear

Clears the event log of all entries.

Key Path	System, Show, LXI, LXI Event Log
Remote Command	:LXI:EVENT:LOG:CLEar
Example	:LXI:EVEN:LOG:CLE
Initial S/W Revision	Prior to A.02.00

Size

Sets the maximum number of entries the LXI Event Log can hold.

Key Path	System, Show, LXI, LXI Event Log
Remote Command	:LXI:EVENT:LOG:SIZE <size> :LXI:EVENT:LOG:SIZE?
Example	:LXI:EVEN:LOG:SIZE 256

Preset	Not affected by a Preset. The default value of "64" can be restored by pressing System, Restore Defaults, Misc.
State Saved	Saved in instrument state.
Range	>= 0
Initial S/W Revision	Prior to A.02.00

Enabled

Enables and disables the logging of LXI Events.

Key Path	System, Show, LXI, LXI Event Log
Remote Command	:LXI:EVENT:LOG:ENABLE ON OFF 1 0 :LXI:EVENT:LOG:ENABLE?
Example	:LXI:EVENT:LOG:ENAB ON
Preset	Not affected by a Preset. The default value of "ON" can be restored by pressing System, Restore Defaults, Misc.
State Saved	Saved in instrument state.
Range	ON OFF 0 1
Initial S/W Revision	Prior to A.02.00

Count (Remote Command Only)

Returns the number of entries currently in the LXI Event Log.

Remote Command	:LXI:EVENT:LOG:COUNT?
Example	:LXI:EVENT:LOG:COUN?
Range	0 – Size
Initial S/W Revision	Prior to A.02.00

Next Entry (Remote Command Only)

Returns the oldest entry from the LXI Event Log and removes it from the log. If the log is empty, an empty string is returned.

Remote Command	:LXI:EVENT:LOG[:NEXT]?
Example	:LXI:EVENT:LOG?
Initial S/W Revision	Prior to A.02.00

All (Remote Command Only)

Non-destructively retrieves the entire contents of the event log. Entries are returned as separate strings, surrounded

System Functions

System

by double quote marks, and separated by a comma. Fields within each entry are also comma delimited.

Remote Command	:LXI:EVENT:LOG:ALL?
Example	:LXI:EVENT:LOG:ALL? Returns the entire event log contents. An example may look like the following: "11/12/2007,18:14:10.770385,Error,LogOverwrite,Rise,,,,","11/12/2007,18:14:10.592105,Status,Measuring,Rise,,,,","11/12/2007,18:14:10.597758,Status,Measuring,Fall,,,,","11/12/2007,18:14:10.597786,Status,Sweeping,Fall,,,,","11/12/2007,18:14:10.599030,Status,WaitingForTrigger,Rise,,,," The contents of the Event Log vary, based on the operation of the instrument.
Initial S/W Revision	Prior to A.02.00

Specific Entry (Remote Command Only)

Non-destructively retrieves a specifically indexed entry from the event log. Fields within an entry are comma delimited.

Remote Command	:LXI:EVENT:LOG:ENTRy? <intIndex>
Example	:LXI:EVENT:LOG:ENTR? 0 Returns the first entry in the event log. An example may look like the following: "11/12/2007,18:14:10.770385,Error,LogOverwrite,Rise,,,," The contents of the Event Log vary, based on the operation of the instrument.
Initial S/W Revision	Prior to A.02.00

Beginning Entry (Remote Command Only)

Sets or freezes the beginning entry of the log when in circular mode to the most recently added entry at the time of the command. This is so that the :LXI:EVENT:LOG:ENTRy? command has a reference entry for indexing individual entries in the log.

Remote Command	:LXI:EVENT:LOG:CIRCular:FBENry
Example	:LXI:EVENT:LOG:CIRC:FBEN
Initial S/W Revision	Prior to A.02.00

Power On

Enables you to select how the instrument should power on. The options are: Mode and Input/Output Defaults, User Preset and Last State.

Key Path	System
Mode	All

Remote Command	:SYSTem:PON:TYPE MODE USER LAST :SYSTem:PON:TYPE?
Example	:SYST:PON:TYPE MODE
Preset	This is unaffected by a Preset but is set to Mode on a “Restore System Defaults->All”
State Saved	No
Backwards Compatibility SCPI	:SYSTem:PON:TYPE PRESet the “PRESet” parameter is supported for backward compatibility only and behaves the same as MODE.
Backwards Compatibility Notes	The Preset Type key in legacy analyzers has been removed, and the Power On toggle key has been replaced by this 1-of-N key in the System menu.
Initial S/W Revision	Prior to A.02.00

Mode and Input/Output Defaults

When the analyzer is powered on in Mode and Input/Output Defaults, it performs a Restore Mode Defaults to all modes in the instrument and also performs a Restore Input/Output Defaults.

Persistent parameters (such as Amplitude Correction tables or Limit tables) are not affected at poweron, even though they are normally cleared by Restore Input/Output Defaults and/or Restore Mode Defaults.

Key Path	System, Power On
Mode	All
Example	SYST:PON:TYPE MODE
Readback Text	Defaults
Initial S/W Revision	Prior to A.02.00

User Preset

Sets **Power On** to **User Preset**. When the analyzer is powered on in User Preset, it will User Preset each mode and switch to the power-on mode. Power On User Preset will not affect any settings beyond what a normal User Preset affects.

NOTE An instrument could never power up for the first time in User Preset.

Key Path	System, Power On
Mode	All
Example	SYST:PON:TYPE USER
Readback Text	User Preset

Backwards Compatibility Notes	Power On User Preset will cause the instrument to power up in the power-on mode, not the last mode the instrument was in prior to shut down. Also, Power On User Preset will User Preset all modes. This does not match legacy behavior exactly.
Initial S/W Revision	Prior to A.02.00

Last State

Sets **Power On to Last**. When the analyzer is powered on, it will put all modes in the last state they were in prior to when the analyzer was put into Power Standby and it will wake up in the mode it was last in prior to powering off the instrument. The saving of the active mode prior to shutdown happens behind the scenes when a controlled shutdown is requested by using the front panel power **Standby** key or by using the remote command SYSTem:PDOWn. The non-active modes are saved as they are deactivated and recalled by Power On Last State.

NOTE

An instrument can never power up for the first time in Last.

If line power to the analyzer is interrupted, for example by pulling the line cord plug or by switching off power to a test rack, Power On Last State may not work properly. For proper operation, Power On Last State depends on you shutting down the instrument using the Standby key or the SYSTem:PDOWn SCPI command. This will ensure the last state of each mode is saved and can be recalled during a power up.

Key Path	System, Power On
Mode	All
Example	SYST:PON:TYPE LAST
Notes	Power on Last State only works if you have done a controlled shutdown prior to powering on in Last. If a controlled shutdown is not done when in Power On Last State, the instrument will power up in the last active mode, but it may not power up in the active mode's last state. If an invalid mode state is detected, a Mode Preset will occur. To control the shutdown under remote control use the :SYSTem:PDOWn command.
Readback Text	Last State
Backwards Compatibility Notes	It is no longer possible to power-up the analyzer in the last mode the analyzer was running with that mode in the preset state. (ESA/PSA SYST:PRESET:TYPE MODE with SYST:PON:PRESET) You can power-on the analyzer in the last mode the instrument was running in its last state (SYST:PON:TYPE LAST), or you can specify the mode to power-up in its preset state (SYST:PON:MODE <mode>).
Initial S/W Revision	Prior to A.02.00

Power On Application

Accesses a menu that lists the available Modes and lets you select which Mode is to be the power-on application.

This application is used for Power On Type “Mode and Input/Output Defaults” and Restore System Defaults All.

Key Path	System, Power On
Mode	All
Remote Command	:SYSTem:PON:MODE SA BASIC ADEMOD NFIGURE PNOISE CDMA2K TDSCDMA VSA VSA89 601 WCDMA WIMAXOFDMA :SYSTem:PON:MODE?
Example	SYST:PON:MODE SA
Notes	The list of possible modes (and remote parameters) to choose from is dependent on which modes are installed in the instrument.
Preset	This is unaffected by a Preset but is set on a “Restore System Defaults->All” to SA.
State Saved	No
Initial S/W Revision	Prior to A.02.00

Configure Applications

The Configure Applications utility lets you do two things:

1. specify a subset of the available applications (Modes) to preload into memory at startup time
2. specify the order in which the Modes appear in the Mode menu

There are several reasons you might want to specify a subset of the available applications (Modes) to preload:

- During runtime, if a Mode which is not preloaded is selected by the user, there will be a pause while the Application is loaded. Configure Applications lets you decide whether you want that delay at startup of the analyzer program or the first time you select the Mode.
- In addition, there are more applications available for the X-Series than can fit into Windows Virtual Memory. The Configure Application utility allows you to choose which licensed applications to load into memory, if you have more licensed than can fit.

The Configure Applications utility can be used to select applications for preload and/or to determine how many applications can fit in memory at one time. This utility consists of a window with instructions, a set of “Select Application” checkboxes, a “fuel bar” style memory gauge, and softkeys that help you set up your configuration.

Preloading Applications

During operation of the analyzer, you select applications from the Mode menu. After startup of the

analyzer program, the first time you select a particular application that application must be loaded into memory. Once loaded, the application stays loaded, so the next time you select it during a session, there is no delay. During runtime, if an application which is not yet loaded into memory is selected using the Mode menu or sending SCPI commands, there will be a pause while the Application is loaded. During this pause a message that says “Loading application, please wait ...” is displayed.

You can use the Configure Applications utility to choose applications to “preload” at startup, to eliminate the runtime delay. If you do this, the delay will instead increase the time it takes to start up the analyzer program, but for many users this is preferable to having to wait the first time they select an application. Asking for an application to be preloaded will cause it to be loaded into the analyzer’s memory when the analyzer program starts up. Once it is loaded into memory, it cannot be unloaded without exiting and restarting the analyzer program.

Virtual memory usage

There are more applications available for the X-Series than can fit into memory at any one time, so the Configure Applications utility includes a memory tracker that serves two purposes:

It will not let you preload more applications than will fit into memory at once.

You can determine how many of your favorite applications can reside in memory at one time.

The utility provides a graphical representation of the amount of memory (note that the memory in question here is Virtual memory and is a limitation imposed by the operating system, not by the amount of physical memory you have in your analyzer). You select applications to preload by checking the boxes on the left. Checked applications preload at startup. The colored fuel bar indicates the total memory required when all the checked applications are loaded (either preloaded or selected during runtime).

Here is what the fuel bar colors mean:

RED: the applications you have selected cannot all fit into the analyzer’s memory. You must deselect applications until the fuel bar turns yellow.

YELLOW: the applications you have selected can all fit into the analyzer’s memory, but there is less than 10% of the memory left, probably not enough to load any other applications, either via preload or by selecting a Mode while the analyzer is running..

GREEN: The indicator is green when <90% of the memory limit is consumed. This means the applications you have selected can all fit into the analyzer’s memory with room to spare. You will likely be able to load one or more other applications without running out of memory.

Access to Configure Applications utility

You may, at any time, manually call up the Configure Applications utility by pressing **System, Power On, Configure Applications**, to find a configuration that works best for you, and then restart the analyzer program.

The utility may also be called if, during operation of the analyzer, you attempt to load more applications than can fit in memory at once.

A version of the utility also runs the first time you power up the analyzer after purchasing it from Agilent. In this case the utility automatically configures preloads so that as many licensed applications as possible are preloaded while keeping the total estimated virtual memory usage below the limit. This

auto-configuration only takes place at the very first run, and after analyzer software upgrades.

Key Path	System, Power On
Example	:SYST:SHOW CAPP Displays the Config Applications screen
Initial S/W Revision	A.02.00

Select All

Marks all applications in the selection list. This allows you to enable all applications licensed on the instrument for pre-loading, or is a convenience for selecting all applications in one operation and then letting you deselect individual applications.

Key Path	System, Power On, Configure Applications
Initial S/W Revision	A.02.00

Deselect All

Clears the marks from all applications in the selection list, with the exception of the Power On application. The Power On application cannot be eliminated from the pre-load list.

Key Path	System, Power On, Configure Applications
Initial S/W Revision	A.02.00

Move Up

The application list is the order in which applications appear in the Mode Menu. This key enables you to shift the selected application up in the list, thus moving the selected application earlier in the Mode Menu.

Key Path	System, Power On, Configure Applications
Initial S/W Revision	A.02.00

Move Down

The application list is the order in which applications appear in the Mode Menu. This key enables you to shift the selected application down in the list, thus moving the selected application later in the Mode Menu.

Key Path	System, Power On, Configure Applications
Initial S/W Revision	A.02.00

Select/Deselect

Toggles the currently highlighted application in the list.

Key Path	System, Power On, Configure Applications
----------	---

System Functions
System

Initial S/W Revision	A.02.00
----------------------	---------

Save Changes and Exit

Applies the configuration of the applications list. The marked applications will be pre-loaded in memory the next time the instrument application is started, and the order of the applications in the list will be the order of the applications in the Mode Menu.

After saving your changes, the analyzer asks you if you would like it to restart so that your changes can take effect (see dialog box, below). If you choose not to restart, no memory will be released until the next time you shut down and restart the analyzer.

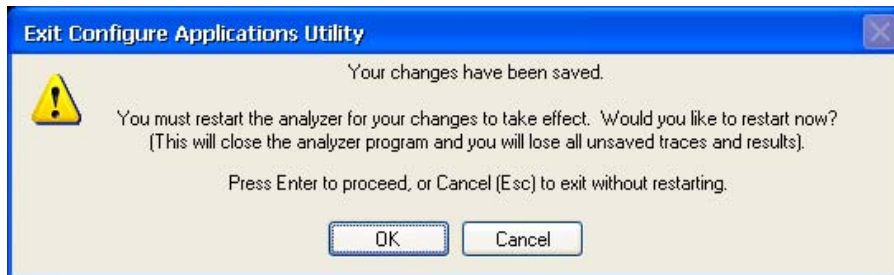

Key Path	System, Power On, Configure Applications
Remote Command	:SYSTem:PUP:PROcEss
Example	:SYST:PUP:PROC This is the SCPI command for restarting the analyzer. You must Wait after this command for the instrument application to restart
Notes	The softkey will be grayed-out when the virtual memory of the selected applications exceeds 100% of the limit.
Notes	You cannot use *WAI or *OPC? to synchronize operation after a restart. This command stops and restarts the instrument application, thus the SCPI operation is terminated and restarted. A remote program must use fixed wait time to resume sending commands to the instrument. The wait time will be dependent upon which applications are pre-loaded.
Initial S/W Revision	A.02.00
Modified at S/W Revision	A.04.00

Exit Without Saving

Pressing this key will exit the Configure Applications utility without saving your changes.

Key Path	System, Power On, Configure Applications
Initial S/W Revision	A.02.00
Modified at S/W Revision	A.04.00

Configure Applications - Instrument boot-up

At start-up of the analyzer programa dialog box similar to the one under the **System, Power On,**

Configure Applications key will be displayed allowing you to choose which licensed applications are to be loaded. This dialog will only be displayed if the memory required to pre-load all of the licensed applications exceeds the Virtual Memory available.

Configure Applications - Windows desktop

The Configure Applications Utility may be run from the Windows Desktop. The utility is launched by



double-clicking the icon on the desktop, which brings-up a dialog box similar to the one under the **System, Power On, Configure Applications** key, allowing you to choose which licensed applications are to be loaded when the analyzer program starts up. This dialog box has mouse buttons on it which do the job that the softkeys normally do in the **System, Power On, Configure Applications** menu.

Configure Applications - Remote Commands

The following topics provide details on the using remote commands to configure the list of applications want to load into the instrument memory or query the Virtual Memory utilization for your applications.

- [“Configuration list \(Remote Command Only\)” on page 241](#)
- [“Configuration Memory Available \(Remote Command Only\)” on page 242](#)
- [“Configuration Memory Total \(Remote Command Only\)” on page 242](#)
- [“Configuration Memory Used \(Remote Command Only\)” on page 242](#)
- [“Configuration Application Memory \(Remote Command Only\)” on page 242](#)

Configuration list (Remote Command Only)

This remote command is used to set or query the list of applications to be loaded in-memory.

Remote Command	:SYSTem:PON:APPLication:LLIST <string of INSTRument:SElect names> :SYSTem:PON:APPLication:LLIST?
Example	:SYST:PON:APPL:LLIS "SA,BASIC,WCDMA"
Notes	<string of INSTRument:SElect names> are from the enums of the :INSTRument:SElect command. The order of the <INSTRument:SElect names> is the order in which the applications are loaded into memory, and the order in which they appear in the Mode Menu. Error message –225 "Out of Memory" is reported when more applications are listed than can reside in Virtual Memory. When this occurs, the existing applications load list is unchanged.
Preset	Not affected by Preset
State Saved	Not saved in instrument state

Initial S/W Revision	A.02.00
----------------------	---------

Configuration Memory Available (Remote Command Only)

This remote command is used to query the amount of Virtual Memory remaining.

Remote Command	:SYSTem:PON:APPLication:VMEMory[:AVAIlable]?
Example	:SYST:PON:APPL:VMEM?
Preset	Not affected by Preset
Initial S/W Revision	A.02.00

Configuration Memory Total (Remote Command Only)

This remote command is used to query the limit of Virtual Memory allowed for applications.

Remote Command	:SYSTem:PON:APPLication:VMEMory:TOTal?
Example	:SYST:PON:APPL:VMEM:TOT?
Preset	Not affected by Preset
Initial S/W Revision	A.02.00

Configuration Memory Used (Remote Command Only)

This remote command is a query of the amount of Virtual Memory used by all measurement applications.

Remote Command	:SYSTem:PON:APPLication:VMEMory:USED?
Example	:SYST:PON:APPL:VMEM:USED?
Preset	Not affected by Preset
Initial S/W Revision	A.02.00

Configuration Application Memory (Remote Command Only)

This remote command is used to query the amount of Virtual Memory a particular application consumes.

Remote Command	:SYSTem:PON:APPLication:VMEMory:USED:NAME? <INSTRument:SElect name>
Example	:SYST:PON:APPL:VMEM:USED:NAME? CDMA2K
Notes	<INSTRument:SElect name> is from the enums of the :INSTRument:SElect command in Meas Common section 13.3 Value returned will be 0 (zero) if the name provided is invalid.
Preset	Not affected by Preset
Initial S/W Revision	Prior to A.02.00

Restore Power On Defaults

This selection causes the Power On Type and Power On Application settings to be a reset to their default values. This level of Restore System Defaults does not affect any other system settings, mode settings and does not cause a mode switch. The Power On key, under the Restore System Defaults menu, causes the same action.

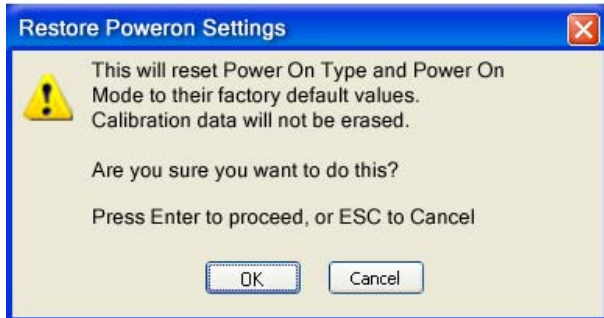

If you press any key other than OK or Enter, it is construed as a Cancel, because the only path that will actually cause the reset to be executed is through OK or Enter.

Key Path	System, Power On
Example	:SYST:DEF PON
Initial S/W Revision	Prior to A.02.00

Alignments

The Alignments Menu controls and displays the automatic alignment of the instrument, and provides the ability to restore the default alignment values.

The current setting of the alignment system is displayed in the system Settings Panel along the top of the display, including a warning icon for conditions that may cause specifications to be impacted.



Key Path	System
Initial S/W Revision	Prior to A.02.00

Auto Align

Configures the method for which the automatic background alignment is run.

Automatic background alignments are run periodically between measurement acquisitions. The instrument's software determines when alignments are to be performed to maintain warranted operation. The recommended setting for Auto Align is Normal.

An Auto Align execution cannot be aborted with the Cancel (ESC) key. To interrupt an Auto Align

System Functions
System

execution, select **Auto Align Off**.

Key Path	System, Alignments
Mode	All
Remote Command	:CALibration:AUTO ON PARTial OFF :CALibration:AUTO?
Example	:CAL:AUTO ON
Notes	While Auto Align is executing, bit 0 of Status Operation register is set.
Couplings	Auto Align is set to Off if Restore Align Data is invoked.
Preset	This is unaffected by Preset but is set to ON upon a “Restore System Defaults->Align”.
State Saved	No
Status Bits/OPC dependencies	When Auto Align is executing, bit 0 in the Status Operational register is set.
Backwards Compatibility SCPI	:CALibration:AUTO ALERT Parameter ALERT is for backward compatibility only and is mapped to PARTial
Backwards Compatibility Notes	ESA SCPI for Auto Align is :CALibration:AUTO <Boolean>. The command for X-Series is an enumeration. Thus the parameters of “0” and “1” are not possible in X-Series. Similarly, the ESA SCPI for :CALibration:AUTO? returned the Boolean value 1 or 0, in X-Series it is an Enumeration (string). Thus, queries by customer applications into numeric variables will result in an error In PSA Auto Align OFF was not completely off, it is equivalent to PARTial in X-Series. In X-Series, OFF will be fully OFF. This means users of PSA SCPI who choose OFF may see degraded performance and should migrate their software to use PARTial.
Initial S/W Revision	Prior to A.02.00

Normal

Auto Align, Normal turns on the automatic alignment of all measurement systems. The Auto Align, Normal selection maintains the instrument in warranted operation across varying temperature and over time.

If the condition “Align Now, All required” is set, transition to Auto Align, Normal will perform the required alignments and clear the “Align Now, All required” condition and then continue with further alignments as required to maintain the instrument adequately aligned for warranted operation.

When **Auto Align, Normal** is selected the Auto Align Off time is set to zero.

When **Auto Align, Normal** is selected the Settings Panel indicates ALIGN AUTO.

Key Path	System, Alignments, Auto Align
----------	---------------------------------------

Mode	All
Example	:CAL:AUTO ON
Notes	<p>Alignment processing as a result of the transition to Normal will be executed sequentially. Thus, *OPC? or *WAI following CAL:AUTO ON will return when the alignment processing is complete.</p> <p>The presence of an external signal may interfere with the RF portion of the alignment. If so, the Error Condition message “Align skipped: 50 MHz interference” or “Align skipped: 4.8 GHz interference” is reported, and bit 11 is set in the Status Questionable Calibration register. After the interfering signal is removed, subsequent alignment of the RF will clear the condition, and clear bit 11 in the Status Questionable Calibration register.</p>
Readback Text	Normal
Status Bits/OPC dependencies	<p>An interfering user signal may prevent automatic alignment of the RF subsystem. If this occurs, the Error Condition message “Align skipped: 50 MHz interference” or “Align skipped: 4.8 GHz interference” is reported, the Status Questionable Calibration bit 11 is set, and the alignment proceeds. When a subsequent alignment of the RF subsystem succeeds, either by the next cycle of automatic alignment or from an Align Now, RF, the Error Condition and Status Questionable Calibration bit 11 are cleared.</p>
Initial S/W Revision	Prior to A.02.00

Partial

Auto Align, Partial disables the full automatic alignment and the maintenance of warranted operation for the benefit of improved measurement throughput. Accuracy is retained for the Resolution Bandwidth filters and the IF Passband which is critical to FFT accuracy, demodulation, and many measurement applications. With Auto Align set to Partial, you are now responsible for maintaining warranted operation by updating the alignments when they expire. The Auto Align, Alert mechanism will notify you when alignments have expired. One solution to expired alignments is to perform the Align All, Now operation. Another is to return the Auto Align selection to Normal.

Auto Align, Partial is recommended for measurements where the throughput is so important that a few percent of improvement is more valued than an increase in the accuracy errors of a few tenths of a decibel. One good application of Auto Align, Partial would be an automated environment where the alignments can be called during overhead time when the device-under-test is exchanged.

When **Auto Align, Partial** is selected the elapsed time counter begins for Auto Align Off time.

When **Auto Align, Partial** is selected the Settings Panel indicates ALIGN PARTIAL with a warning icon. The warning icon is to inform the operator that they are responsible for maintaining the warranted operation of the instrument

Key Path	System, Alignments, Auto Align
Mode	All
Example	:CAL:AUTO PART
Notes	Auto Align Partial begins the elapsed time counter for Auto Align Off time.

System Functions
System

Readback Text	Partial
Initial S/W Revision	Prior to A.02.00

Off

Auto Align, Off disables automatic alignment and the maintenance of warranted operation, for the benefit of maximum measurement throughput. With Auto Align set to Off, you are now responsible for maintaining warranted operation by updating the alignments when they expire. The Auto Align, Alert mechanism will notify you when alignments have expired. One solution to expired alignments is to perform the Align All, Now operation. Another is to return the Auto Align selection to Normal.

The Auto Align, Off setting is rarely the best choice, because Partial gives almost the same improvement in throughput while maintaining the warranted performance for a much longer time. The choice is intended for unusual circumstances such as the measurement of radar pulses where you might like the revisit time to be as consistent as possible.

When **Auto Align, Off** is selected the Auto Align Off time is initialized and the elapsed time counter begins.

When **Auto Align, Off** is selected the Settings Panel indicates ALIGN OFF with a warning icon. The warning icon is to inform the operator that they are responsible for maintaining the warranted operation of the instrument:

Key Path	System, Alignments, Auto Align
Mode	All
Example	:CAL:AUTO OFF
Notes	Auto Align Off begins the elapsed time counter for Auto Align Off time.
Couplings	Auto Align is set to Off if Restore Align Data is invoked.
Readback Text	Off
Initial S/W Revision	Prior to A.02.00

All but RF

Auto Align, All but RF, configures automatic alignment to include or exclude the RF subsystem. (Eliminating the automatic alignment of the RF subsystem prevents the input impedance from changing. The normal input impedance of 50 ohms can change to an open circuit when alignments are being used. Some devices under test do not behave acceptably under such circumstances, for example by showing instability.) When Auto Align, All but RF ON is selected, the operator is responsible for performing an Align Now, RF when RF-related alignments expire. The Auto Align, Alert mechanism will notify the operator to perform an Align Now, All when the combination of time and temperature variation is exceeded.

When **Auto Align, All but RF ON** is selected the Settings Panel indicates ALIGN AUTO/NO RF with a warning icon (warning icon is intended to inform the operator they are responsible for the maintaining the RF alignment of the instrument):

Key Path	System, Alignments, Auto Align
----------	---------------------------------------

Mode	All
Remote Command	:CALibration:AUTO:MODE ALL NRF :CALibration:AUTO:MODE?
Example	:CAL:AUTO:MODE NRF
Preset	This is unaffected by Preset but is set to ALL on a “Restore System Defaults->Align”.
State Saved	No
Readback Text	RF or NRF
Initial S/W Revision	Prior to A.02.00

Alert

The instrument will signal an Alert when conditions exist such that you will need to perform a full alignment (for example, Align Now, All). The Alert can be configured in one of four settings; Time & Temperature, 24 hours, 7 days, or None. A confirmation is required when a selection other than Time & Temperature is chosen. This prevents accidental deactivation of alerts.

With **Auto Align** set to **Normal**, the configuration of **Alert** is not relevant because the instrument’s software maintains the instrument in warranted operation.

Key Path	System, Alignments, Auto Align
Mode	All
Remote Command	:CALibration:AUTO:ALERT TTEMPerature DAY WEEK NONE :CALibration:AUTO:ALERT?
Example	:CAL:AUTO:ALERT TTEMP
Notes	The alert that alignment is needed is the setting of bit 14 in the Status Questionable Calibration register.
Preset	This is unaffected by Preset but is set to TTEMPerature on a “Restore System Defaults->Align”.
State Saved	No
Status Bits/OPC dependencies	The alert is the Error Condition message “Align Now, All required” and bit 14 is set in the Status Questionable Calibration register.
Initial S/W Revision	Prior to A.02.00

Time & Temperature

With Auto Align Alert set to Time & Temperature the instrument will signal an alert when alignments expire due to the combination of the passage of time and changes in temperature. The alert is the Error Condition message “Align Now, All required”. If this choice for Alert is selected, the absence of an alert means that the analyzer alignment is sufficiently up-to-date to maintain warranted accuracy.

Key Path	System, Alignments, Auto Align, Alert
----------	--

System Functions
System

Mode	All
Example	:CAL:AUTO:ALERTTEM
Readback Text	Time & Temp
Status Bits/OPC dependencies	Bit 14 is set in the Status Questionable Calibration register.
Initial S/W Revision	Prior to A.02.00

24 hours

With Auto Align Alert set to 24 Hours the instrument will signal an alert after a time span of 24 hours since the last successful full alignment (for example, Align Now, All or completion of a full Auto Align). You may choose this selection in an environment where the temperature is stable on a daily basis at a small risk of accuracy errors in excess of the warranted specifications. The alert is the Error Condition message “Align Now, All required”.

For front-panel operation, confirmation is required to transition into this setting of Alert. The confirmation dialog is:

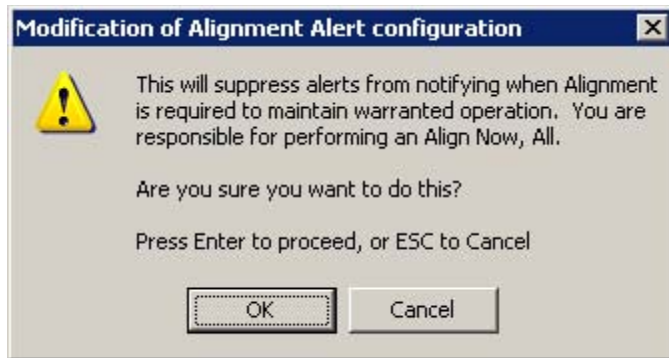

No confirmation is required when Alert is configured through a remote command.

Key Path	System, Alignments, Auto Align, Alert
Mode	All
Example	:CAL:AUTO:ALERTDAY
Readback Text	24 hours
Status Bits/OPC dependencies	Bit 14 is set in the Status Questionable Calibration register.
Initial S/W Revision	Prior to A.02.00

7 days

With Auto Align Alert is set to 7 days the instrument will signal an alert after a time span of 168 hours since the last successful full alignment (for example, Align Now, All or completion of a full Auto Align). You may choose this selection in an environment where the temperature is stable on a weekly basis, at a modest risk of accuracy degradations in excess of warranted performance. The alert is the Error Condition message “Align Now, All required”.

For front panel operation, confirmation is required for the customer to transition into this setting of Alert. The confirmation dialog is:

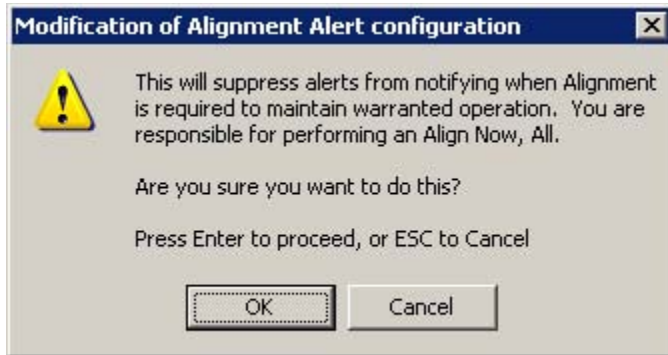

No confirmation is required when Alert is configured through a remote command.

Key Path	System, Alignments, Auto Align, Alert
Mode	All
Example	:CAL:AUTO:ALER WEEK
Readback Text	7 days
Status Bits/OPC dependencies	Bit 14 is set in the Status Questionable Calibration register.
Initial S/W Revision	Prior to A.02.00

None

With Auto Align Alert set to None the instrument will not signal an alert. This is provided for rare occasions where you are making a long measurement which cannot tolerate Auto Align interruptions, and must have the ability to capture a screen image at the end of the measurement without an alert posted to the display. Agilent does not recommend using this selection in any other circumstances, because of the risk of accuracy performance drifting well beyond expected levels without the operator being informed.

For front panel operation, confirmation is required to transition into this setting of Alert. The confirmation dialog is:

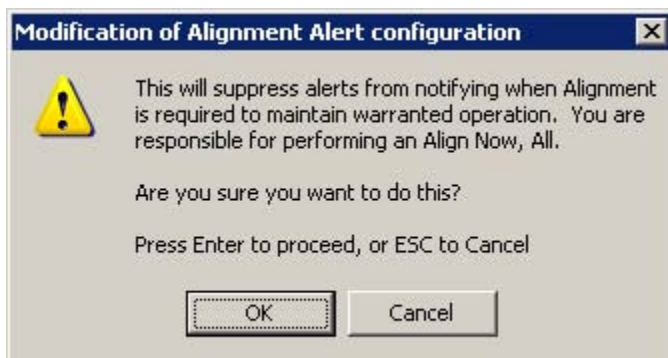

No confirmation is required when Alert is configured through a remote command.

Key Path	System, Alignments, Auto Align, Alert
----------	--

System Functions

System

Mode	All
Example	:CAL:AUTO:ALER NONE
Initial S/W Revision	Prior to A.02.00

Align Now

Accesses alignment processes that are immediate action operations. They perform complete operations and run until they are complete.

Key Path	System, Alignments
Initial S/W Revision	Prior to A.02.00

All

Immediately executes an alignment of all subsystems. The instrument stops any measurement currently underway, performs the alignment, then restarts the measurement from the beginning (similar to pressing the **Restart** key).

If an interfering user signal is present at the RF Input, the alignment is performed on all subsystems except the RF. After completion, the Error Condition message “Align skipped: 50 MHz interference” or “Align skipped: 4.8 GHz interference” is generated. In addition the Error Condition message “Align Now, RF required” is generated, and bits 11 and 12 are set in the Status Questionable Calibration register.

The query form of the remote commands (:CALibration[:ALL]? or *CAL?) invokes the alignment of all subsystems and returns a success or failure value. An interfering user signal is not grounds for failure; if the alignment was able to succeed on all portions but unable to align the RF because of an interfering signal, the resultant will be the success value.

Successful completion of **Align Now, All** will clear the “Align Now, All required” Error Condition, and clear bit 14 in the Status Questionable Calibration register. It will also begin the elapsed time counter for Last Align Now, All Time, and capture the Last Align Now, All Temperature.

If the Align RF subsystem succeeded in aligning (no interfering signal present), the elapsed time counter begins for Last Align Now, RF Time, and the temperature is captured for the Last Align Now, RF Temperature. In addition the Error Conditions “Align skipped: 50 MHz interference” and “Align skipped: 4.8 GHz interference” are cleared, the Error Condition “Align Now, RF required” is cleared, and bits 11 and 12 are cleared in the Status Questionable Calibration register

Align Now, All can be interrupted by pressing the Cancel (ESC) front-panel key or remotely with Device Clear followed by the :ABORT SCPI command. When this occurs the Error Condition message “Align Now, All required” is generated, and bit 14 is set in the Status Questionable Condition register. This is because new alignment data may be employed for an individual subsystem, but not a cohesive set of data for all subsystems.

In many cases, you might find it more convenient to change alignments to Normal, instead of executing Align Now, All. When the Auto Align process transitions to Normal, the analyzer will immediately start to update only the alignments that have expired, thus efficiently restoring the alignment process.

In models with the RF Preselector, such as the N9038A, the Align Now All alignment will immediately execute an alignment of all subsystems in the Spectrum Analyzer and partial subsystems of the RF

Preselector. The additional alignments are the System Gain, Mechanical attenuator and Electronic attenuator alignments on the RF Preselector path. The purpose of these alignments is to improve the RF Preselector path amplitude variation compared to the bypass path.

Key Path	System, Alignments, Align Now
Mode	All
Remote Command	:CALibration[:ALL] :CALibration[:ALL]?
Example	:CAL
Notes	:CALibration[:ALL]? returns 0 if successful :CALibration[:ALL]? returns 1 if failed :CALibration[:ALL]? is the same as *CAL? While Align Now, All is performing the alignment, bit 0 in the Status Operation register is set. Completion, or termination, will clear bit 0 in the Status Operation register. This command is sequential; it must complete before further SCPI commands are processed. Interrupting the alignment from remote is accomplished by invoking Device Clear followed by the :ABORt command. Successful completion will clear bit 14 in the Status Questionable Calibration register. An interfering user signal is not grounds for failure of Align Now, All. However, bits 11 and 12 are set in the Status Questionable Calibration register to indicate Align Now, RF is required. An interfering user supplied signal will result in the instrument requiring an Align Now, RF with the interfering signal removed.
Couplings	Initializes the time for the Last Align Now, All Time. Records the temperature for the Last Align Now, All Temperature. If Align RF component succeeded, initializes the time for the Last Align Now, RF Time. If Align RF component succeeded, records the temperature for the Last Align Now, RF Temperature.
Status Bits/OPC dependencies	Bits 11, 12, or 14 may be set in the Status Questionable Calibration register.
Initial S/W Revision	Prior to A.02.00

Mode	All
Remote Command	*CAL?
Example	*CAL?

Notes	<p>*CAL? returns 0 if successful</p> <p>*CAL? returns 1 if failed</p> <p>:CALibration[:ALL]? is the same as *CAL?</p> <p>See additional remarks described with :CALibration[:ALL]?</p> <p>Everything about :CALibration[:ALL]? is synonymous with *CAL? including all conditions, status register bits, and couplings</p>
Initial S/W Revision	Prior to A.02.00

All but RF

Immediately executes an alignment of all subsystems except the RF subsystem. The instrument will stop any measurement currently underway, perform the alignment, and then restart the measurement from the beginning (similar to pressing the Restart key). This can be used to align portions of the instrument that are not impacted by an interfering user input signal.

This operation might be chosen instead of **All** if you do not want the device under test to experience a large change in input impedance, such as a temporary open circuit at the analyzer input.

The query form of the remote commands (:CALibration:NRF?) will invoke the alignment and return a success or failure value.

Successful completion of Align Now, All but RF will clear the “Align Now, All required” Error Condition, and clear bit 14 in the Status Questionable Calibration register. If “Align Now, All required” was in effect prior to executing the All but RF, the Error Condition message “Align Now, RF required” is generated and bit 12 in the Status Questionable Calibration register is set. It will also begin the elapsed time counter for Last Align Now, All Time, and capture the Last Align Now, All Temperature.

Align Now, All but RF can be interrupted by pressing the Cancel (ESC) front-panel key or remotely with Device Clear followed by the :ABORt SCPI command. When this occurs the Error Condition message “Align Now, All required” is generated, and bit 14 is set in the Status Questionable Condition register. This is because new alignment data may be used for an individual subsystem, but not a full new set of data for all subsystems.

In models with the RF Preselector, such as the N9038A, the “All but RF” alignment will execute an alignment of all subsystems except the RF subsystem of the Spectrum Analyzer, as well as the system gain of the RF Preselector.

Key Path	System, Alignments, Align Now
Mode	All
Remote Command	:CALibration:NRF :CALibration:NRF?
Example	:CAL:NRF

Notes	<p>:CALibration:NRF? returns 0 if successful</p> <p>:CALibration:NRF? returns 1 if failed</p> <p>While Align Now, All but RF is performing the alignment, bit 0 in the Status Operation register is set. Completion, or termination, will clear bit 0 in the Status Operation register.</p> <p>This command is sequential; it must complete before further SCPI commands are processed. Interrupting the alignment from remote is accomplished by invoking Device Clear followed by the :ABORt command.</p> <p>Successful completion will clear bit 14 in the Status Questionable Calibration register and set bit 12 if invoked with “Align Now, All required”.</p>
Couplings	<p>Initializes the time for the Last Align Now, All Time.</p> <p>Records the temperature for the Last Align Now, All Temperature.</p>
Status Bits/OPC dependencies	Bits 12 or 14 may be set in the Status Questionable Calibration register.
Initial S/W Revision	Prior to A.02.00

RF

Immediately executes an alignment of the RF subsystem. The instrument stops any measurement currently underway, performs the alignment, then restarts the measurement from the beginning (similar to pressing the **Restart** key).

This operation might be desirable if the alignments had been set to not include RF alignments, or if previous RF alignments could not complete because of interference which has since been removed.

If an interfering user signal is present at the RF Input, the alignment will terminate and generate the Error Condition message “Align skipped: 50 MHz interference” or “Align skipped: 4.8 GHz interference”, and Error Condition “Align Now, RF required”. In addition, bits 11 and 12 will be set in the Status Questionable Calibration register.

The query form of the remote commands (:CALibration:RF?) will invoke the alignment of the RF subsystem and return a success or failure value. An interfering user signal is grounds for failure.

Successful completion of Align Now, RF will begin the elapsed time counter for Last Align Now, RF Time, and capture the Last Align Now, RF Temperature.

Align Now, RF can be interrupted by pressing the Cancel (ESC) front-panel key or remotely with Device Clear followed by the :ABORt SCPI command. When this occurs, the Error Condition message “Align Now, RF required” is generated, and bit 12 is set in the Status Questionable Condition register. None of the new alignment data is used.

In models with the RF Preselector, such as the N9038A, the RF alignment will execute an alignment of the RF subsystem of the Spectrum Analyzer, as well as the RF subsystem on RF Preselector path.

Key Path	System, Alignments, Align Now
Mode	All
Remote Command	<p>:CALibration:RF</p> <p>:CALibration:RF?</p>

Example	:CAL:RF
Notes	<p>:CALibration:RF? returns 0 if successful</p> <p>:CALibration:RF? returns 1 if failed (including interfering user signal)</p> <p>While Align Now, RF is performing the alignment, bit 0 in the Status Operation register is set. Completion, or termination, will clear bit 0 in the Status Operation register.</p> <p>This command is sequential; it must complete before further SCPI commands are processed. Interrupting the alignment from remote is accomplished by invoking Device Clear followed by the :ABORt command.</p> <p>Successful completion clears the Error Conditions “Align skipped: 50 MHz interference” and “Align skipped: 4800 MHz interference” and the Error Conditions “Align RF failed” and “Align Now, RF required”, and clears bits 3, 11, and 12 in the Status Questionable Calibration register.</p> <p>A failure encountered during alignment will generate the Error Condition message “Align RF failed” and set bit 3 in the Status Questionable Calibration register.</p> <p>An interfering user signal will result in bits 11 and 12 to be set in the Status Questionable Calibration register to indicate Align Now, RF is required.</p> <p>An interfering user supplied signal will result in the instrument requiring an Align Now, RF with the interfering signal removed.</p>
Couplings	<p>Initializes the time for the Last Align Now, RF Time.</p> <p>Records the temperature for the Last Align Now, RF Temperature.</p>
Status Bits/OPC dependencies	Bits 11, 12, or 14 may be set in the Status Questionable Calibration register.
Initial S/W Revision	Prior to A.02.00

External Mixer

Immediately executes an alignment of the External Mixer which is plugged into the USB port. The instrument stops any measurement currently underway, performs the alignment, then restarts the measurement from the beginning (similar to pressing the Restart key). As this alignment calibrates the LO power to the mixer, this is considered an LO alignment; and failure is classified as an LO alignment failure.

The query form of the remote commands (:CALibration:EMIXer?) will invoke the alignment of the External Mixer and return a success or failure value.

Key Path	System, Alignments, Align Now
Mode	All
Remote Command	<p>:CALibration:EMIXer</p> <p>:CALibration:EMIXer?</p>
Example	:CAL:EMIX

Notes	<p>:CAL:EMIX? returns 0 if successful</p> <p>:CAL:EMIX? returns 1 if failed</p> <p>While Align Now, Ext Mix is performing the alignment, bit 0 in the Status Operation register is set. Completion, or termination, will clear bit 0 in the Status Operation register.</p> <p>This command is sequential; it must complete before further SCPI commands are processed. Interrupting the alignment from remote is accomplished by invoking Device Clear followed by the :ABORT command.</p> <p>A failure encountered during alignment will generate the Error Condition message "Align LO failed" and set bit 5 in the Status Questionable Calibration register. Successful completion will clear the "Align LO failed" message and bit 5 in the Status Questionable Calibration register.</p>
Dependencies	This key does not appear unless option EXM is present and is grayed out unless a USB mixer is plugged in to the USB.
Status Bits/OPC dependencies	Bit3 may be set in the Status Questionable Calibration Extended Failure register.
Initial S/W Revision	A.08.00

Show Alignment Statistics

Shows alignment information you can use to ensure that the instrument is operating in a specific manner. The Show Alignment Statistics screen is where you can view time and temperature information.

Values which are displayed are only updated when the Show Alignment Statistics screen is invoked, they are not updated while the Show Alignment Statistics screen is being displayed. The remote commands which access this information obtain current values.

An example of the Show Alignment Statistics screen would be similar to:

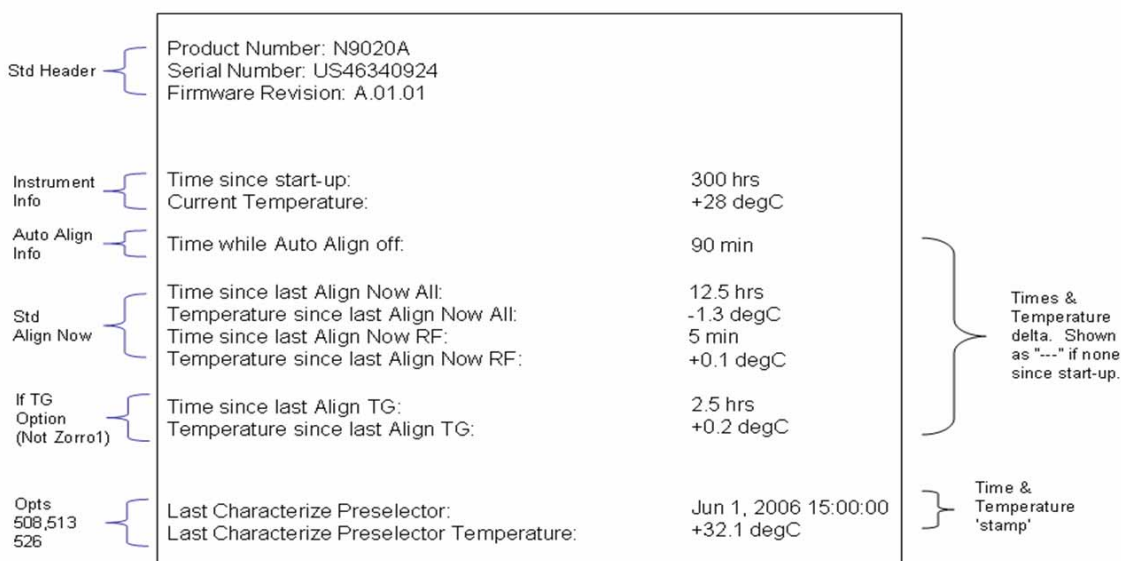

System Functions
System

A successful Align Now, RF will set the Last Align RF temperature to the current temperature, and reset the Last Align RF time. A successful Align Now, All or Align Now, All but RF will set the Last Align Now All temperature to the current temperature, and reset the Last Align Now All time. A successful Align Now, All will also reset the Last Align RF items if the RF portion of the Align Now succeeded.

Key Path	System, Alignments
Mode	All
Notes	The values displayed on the screen are only updated upon entry to the screen and not updated while the screen is being displayed.
Initial S/W Revision	Prior to A.02.00

Key Path	Visual annotation in the Show Alignment Statistics screen
Mode	All
Remote Command	:SYSTem:PON:TIME?
Example	:SYST:PON:TIME?
Notes	Value is the time since the most recent start-up in seconds.
State Saved	No
Initial S/W Revision	Prior to A.02.00

Key Path	Visual annotation in the Show Alignment Statistics screen
Mode	All
Remote Command	:CALibration:TEMPerature:CURRent?
Example	:CAL:TEMP:CURR?
Notes	Value is in degrees Centigrade. Value is invalid if using default alignment data (Align Now, All required)
State Saved	No
Initial S/W Revision	Prior to A.02.00

Key Path	Visual annotation in the Show Alignment Statistics screen
Mode	All
Remote Command	:CALibration:TIME:LALL?
Example	:CAL:TIME:LALL?
Notes	Value is the elapsed time, in seconds, since the last successful Align Now, All or Align Now, All but RF was executed.
State Saved	No
Initial S/W Revision	Prior to A.02.00

Key Path	Visual annotation in the Show Alignment Statistics screen
Mode	All
Remote Command	:CALibration:TEMPerature:LALL?
Example	:CAL:TEMP:LALL?
Notes	Value is in degrees Centigrade at which the last successful Align Now, All or Align Now, All but RF was executed.
State Saved	No
Initial S/W Revision	Prior to A.02.00

Key Path	Visual annotation in the Show Alignment Statistics screen
Mode	All
Remote Command	:CALibration:TIME:LRF?
Example	:CAL:TIME:LRF?
Notes	Value is the elapsed time, in seconds, since the last successful Align Now, RF was executed, either individually or as a component of Align Now, All.
State Saved	No
Initial S/W Revision	Prior to A.02.00

Key Path	Visual annotation in the Show Alignment Statistics screen
Mode	All
Remote Command	:CALibration:TEMPerature:LRF?
Example	:CAL:TEMP:LRF?
Notes	Value is in degrees Centigrade at which the last successful Align Now, RF was executed, either individually or as a component of Align Now, All.
State Saved	No
Initial S/W Revision	Prior to A.02.00

Key Path	Visual annotation in the Show Alignment Statistics screen
Mode	All
Remote Command	:CALibration:TIME:SOURce:LALL?
Example	:CAL:TIME:SOUR:LALL?
Notes	Value is the date and time of the last successful Align Now, Source was performed on the instrument. Returns NaN if no Align Now, Source has ever been performed on the instrument.
State Saved	No

System Functions
System

Initial S/W Revision	A.05.00
----------------------	---------

Key Path	Visual annotation in the Show Alignment Statistics screen
Mode	All
Remote Command	:CALibration:TEMPerature:SOURce: LALL?
Example	:CAL:TEMP:SOUR:LALL?
Notes	Value is in degrees Centigrade at which the last successful was performed on the instrument.
State Saved	No
Initial S/W Revision	A.05.00

Key Path	Visual annotation in the Show Alignment Statistics screen
Mode	All
Remote Command	:CALibration:TIME:LPreselector?
Example	:CAL:TIME:LPR?
Notes	Value is the date and time the last successful Characterize Preselector was executed. The date is separated from the time by a space character. Returns "" if no Characterize Preselector has ever been performed on the instrument.
Dependencies	In models that do not include preselectors, this command is not enabled and any attempt to set or query will yield an error.
State Saved	No
Initial S/W Revision	Prior to A.02.00

Key Path	Visual annotation in the Show Alignment Statistics screen
Mode	All
Remote Command	:CALibration:TEMPerature:LPreselector?
Example	:CAL:TEMP:LPR?
Notes	Value is in degrees Centigrade at which the last successful Characterize Preselector was executed.
Dependencies	In models that do not include preselectors, this command is not enabled and any attempt to set or query will yield an error.
State Saved	No
Initial S/W Revision	Prior to A.02.00

Key Path	Visual annotation in the Show Alignment Statistics screen
Mode	All

Remote Command	:CALibration:AUTO:TIME:OFF?
Example	:CAL:AUTO:TIME:OFF?
Notes	Value is the elapsed time, in seconds, since Auto Align has been set to Off or Off with Alert. The value is 0 if Auto Align is ALL or NORF.
State Saved	No
Initial S/W Revision	Prior to A.02.00

Key Path	Visual annotation in the Show Alignment Statistics screen
Mode	All
Remote Command	:CALibration:TIME:RFPSector:LCONducted?
Example	:CAL:TIME:RFPS:LCON?
State Saved	No
Restriction and Notes	Values are the date and time the last successful Align Now, 20 Hz – 30 MHz was executed. The date is separated from the time by a semi-colon character.

Key Path	Visual annotation in the Show Alignment Statistics screen
Mode	All
Remote Command	:CALibration:TEMPerature:RFPSector:LCONducted?
Example	:CAL:TEMP:RFPS:LCON?
State Saved	No
Restriction and Notes	Value is in degrees Centigrade at which the last successful Align Now, 20 Hz – 30 MHz was executed.

Key Path	Visual annotation in the Show Alignment Statistics screen
Mode	All
Remote Command	:CALibration:TIME:RFPSector:LRADiated?
Example	:CAL:TIME:RFPS:LRAD?
State Saved	No
Restriction and Notes	Value is the date and time the last successful Align Now, 30 MHz – 3.6 GHz was executed. The date is separated from the time by a semi-colon character.

Key Path	Visual annotation in the Show Alignment Statistics screen
Mode	All
Remote Command	:CALibration:TEMPerature:RFPSector:LRADiated?
Example	:CAL:TEMP:RFPS:LRAD?

System Functions
System

State Saved	No
Restriction and Notes	Value is in degrees Centigrade at which the last successful Align Now, 30 MHz – 3.6 GHz was executed.

Key Path	Visual annotation in the Show Alignment Statistics screen
Mode	All
Remote Command	:CALibration:RFPSelector:SCHeduler:TIME:NEXT? This query returns data using the following format “YYYY/MM/DD; HH:MM:SS”
Example	:CAL:RFPS:SCH:TIME:NEXT?
State Saved	No
Restriction and Notes	The next run time will be updated based on the start date/time and recurrence set by the users. “date” is representation of the date the task will run in the form of “YYYY/MM/DD” where: YYYY is the four digit representation of year. (for example, 2009) MM is the two digit representation of month. (for example, 01 to 12) DD is the two digit representation of the day. (for example, 01 to 28, 29, 30 or 31 depending on the month and year) “time” is a representation of the time of day the task will run in the form of “HH:MM:SS” where: HH is the two digit representation of the hour in 24 hour format MM is the two digit representation of minute SS is the two digit representation of seconds For model N9038A only.

Restore Align Defaults

Initializes the alignment user interface settings, not alignment data, to the factory default values. Align Now, All must be executed if the value of the Timebase DAC results in a change.

For front panel operation, you are prompted to confirm action before setting the alignment parameters to factory defaults:

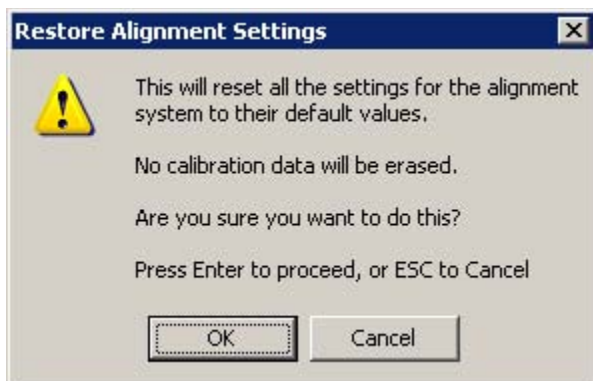

The parameters affected are:

Parameter	Setting
Timebase DAC	Calibrated
Timebase DAC setting	Calibrated value
Auto Align State	Normal (if the instrument is not operating with default alignment data, Off otherwise)
Auto Align All but RF	Off
Auto Align Alert	Time & Temperature

Key Path	System, Alignments
Mode	All
Example	:SYST:DEF ALIG
Notes	Alignment processing that results as the transition to Auto Alignment Normal will be executed sequentially; thus *OPC? or *WAI will wait until the alignment processing is complete.
Initial S/W Revision	Prior to A.02.00

Backup or Restore Align Data...

Opens the utility for backing-up or restoring the alignment data.

Alignment data for the instrument resides on the hard drive in a database. Agilent uses high quality hard drives; however it is highly recommended the alignment data be backed-up to storage outside of the instrument. Additionally, for customers who use multiple CPU Assemblies or multiple disk drives, the alignment that pertains to the instrument must be transferred to the resident hard drive after a CPU or hard drive is replaced. This utility facilitates backing-up and restoring the alignment data.

NOTE This utility allows the operator to navigate to any location of the Windows file system. It is intended that the operator use a USB memory device or Mapped Network Drive to back up the alignment data to storage outside of the instrument.

Key Path	System, Alignments
Initial S/W Revision	A.02.00

Key Path	System, Alignments
Mode	All
Remote Command	:CALibration:DATA:DEFault
Example	:CAL:DATA:DEF
Couplings	Sets Auto Align to Off. Sets bit 14 in the Status Questionable Calibration register. The Error Condition message “Align Now, All required” is generated.
Initial S/W Revision	Prior to A.02.00

Alignment Data Wizard

The Backup or Restore Alignment Data wizard will guide you through the operation of backing-up or restoring the alignment data.

The following dialogue boxes operate without a mouse or external keyboard when you use the default file names.

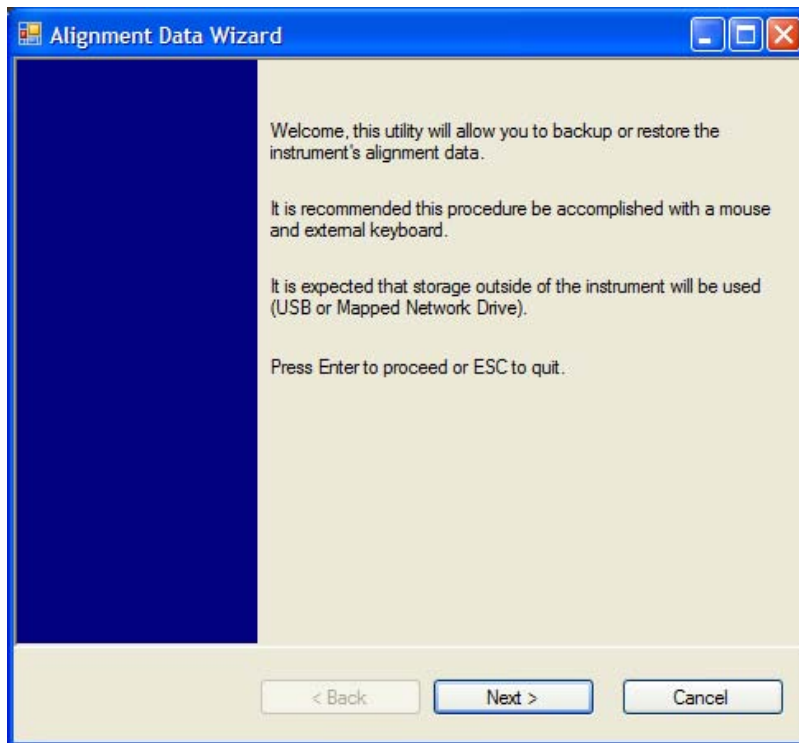

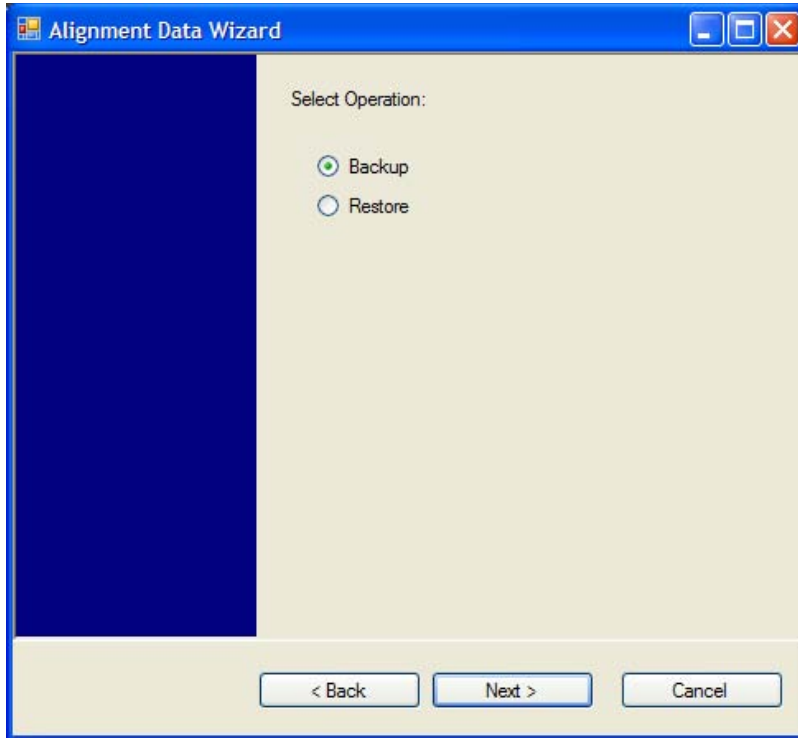

The backup screen will indicate the approximate amount of space required to contain the backup file.

The default file name will be AlignDataBackup_<model number>_<serial number>_<date in YYYYMMDDHHMMSS>.bak.

For the N9030A the default backup location will be the internal F: drive which is a solid-state memory device located internally on the instrument.

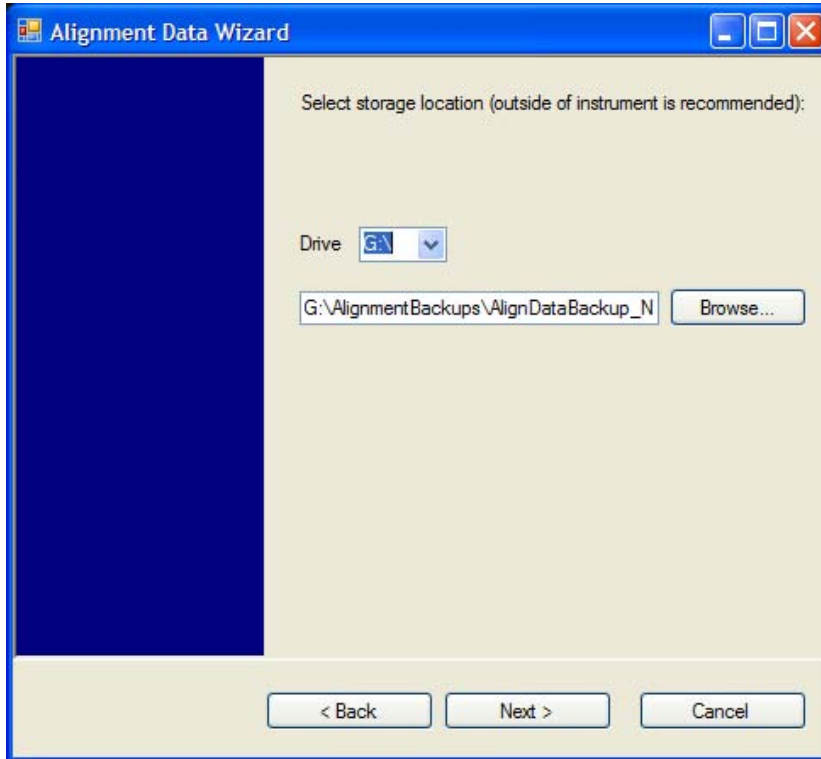

Changing the drive letter will also modify the path displayed in the box below. When this step is first loaded, the drive drop-down is populated with connected drives which provide the user with write access. If there are many unreachable network drives connected to the instrument, this step can take a few seconds. If a USB drive is present, it will be selected by default. The path defaults to the AlignmentBackups folder, and a filename will be automatically created in the form of AlignDataBackup_<model>_<serial number>_<date><time>. When the "Next >" button is pressed, the user will be prompted to create a new folder if the chosen path does not yet exist.

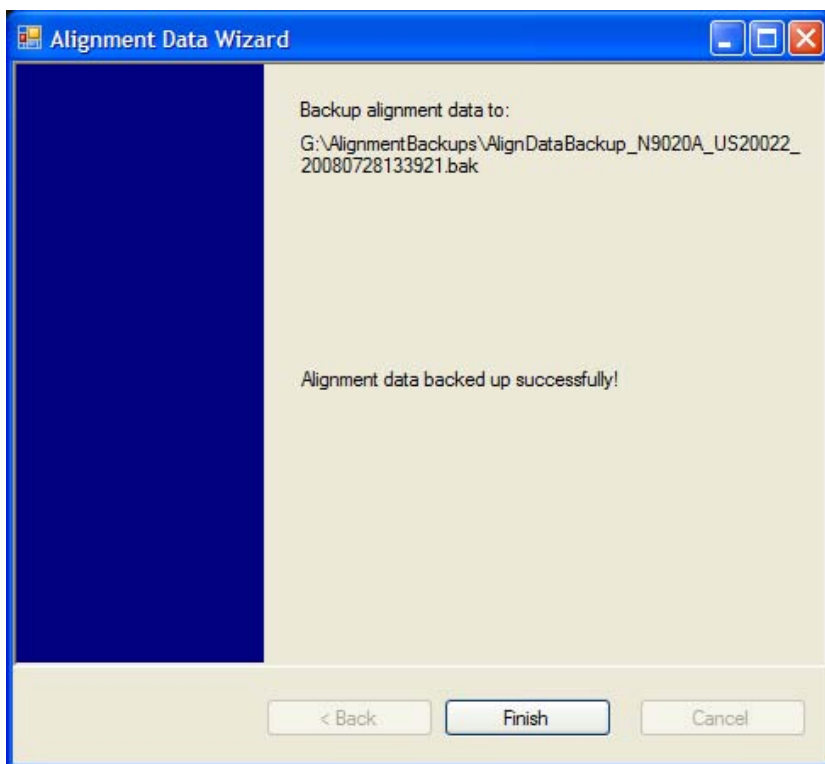
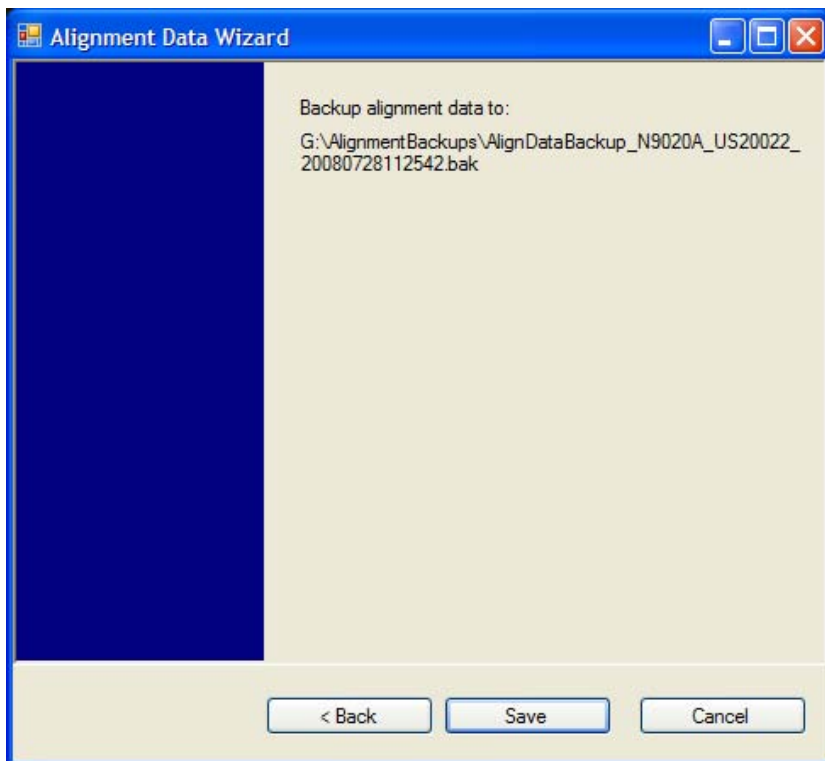

The restore operation will check the validity of the restore file using the database's built-in file validation. If the restore file is corrupt, the existing alignment data will remain in use.

If the serial number information in the backup file being restored is different from that of the instrument,

System Functions System

the following message appears (the serial number shown are examples):

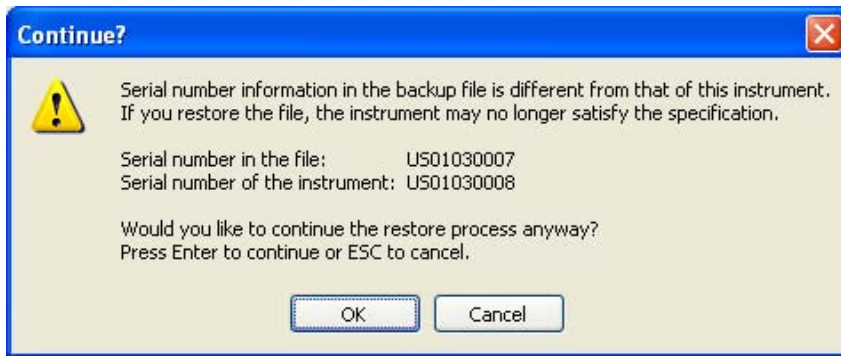

For the N9030A, the default restore location will be the internal F: drive which is a solid-state memory device located internally on the instrument. The default restore file will be the most recent file that matches the default backup file name format: AlignDataBackup_N9030A_<serial number>_<date>.bak

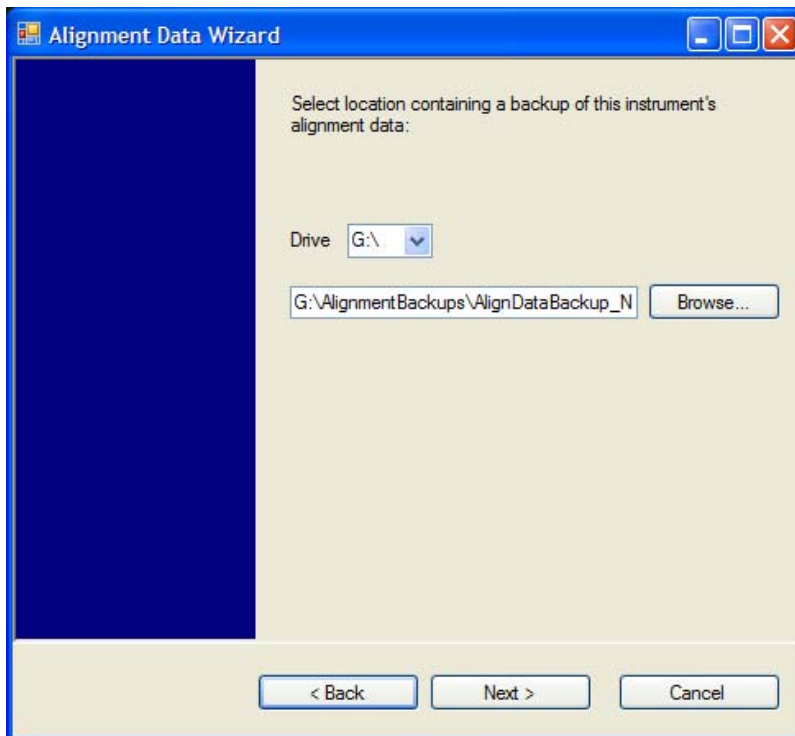

Changing the drive letter will also modify the path displayed in the box below. When this step is first loaded, the drive drop-down is populated with connected drives which provide the user with read access. The path defaults to the AlignBackups folder. The most recent *.bak file in the folder will also be selected by default.

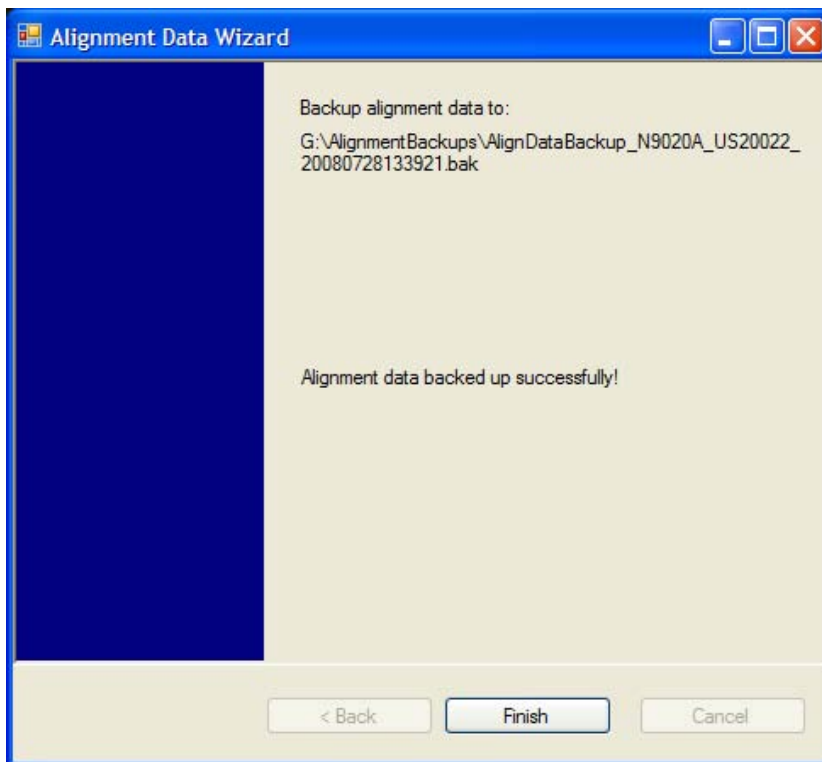
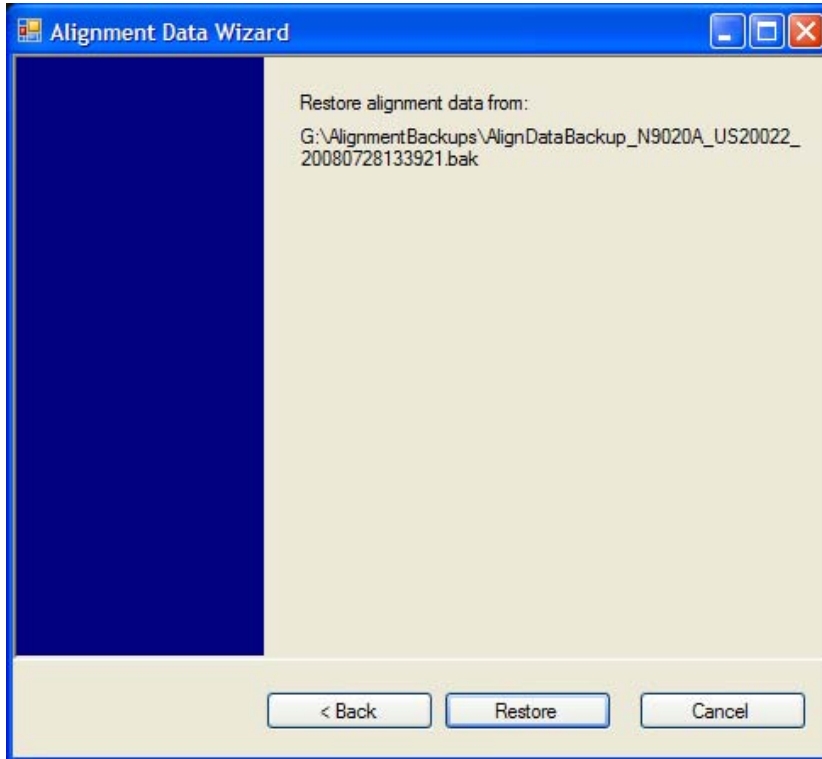

Perform Backup (Remote Command Only)

Invokes an alignment data backup operation to the provided Folder.

NOTE It is recommended that the Folder provided is outside of the instrument (USB or Mapped Network Drive).

Remote Command	:CALibration:DATA:BACKup <filename>
Example	:CAL:DATA:BACK "F:\AlignDataBackup_N9020A_US00000001_2008140100.bak"
Initial S/W Revision	A.02.00

Perform Restore (Remote Command Only)

Invokes an alignment data restore operation from the provided filename.

Remote Command	:CALibration:DATA:RESTore <filename>
Example	:CAL:DATA:REST "F:\ AlignDataBackup_N9020A_US00000001_2008140100.bak "
Initial S/W Revision	A.02.00

Advanced

Accesses alignment processes that are immediate action operations that perform operations that run until complete. Advanced alignments are performed on an irregular basis, or require additional operator interaction

Key Path	System, Alignments
Initial S/W Revision	Prior to A.02.00

Characterize Preselector

The Preselector tuning curve drifts over temperature and time. Recognize that the Amplitude, Presel Center function adjusts the preselector for accurate amplitude measurements at an individual frequency. Characterize Preselector improves the amplitude accuracy by ensuring the Preselector is approximately centered at all frequencies without the use of the Amplitude, Presel Center function. Characterize Preselector can be useful in situations where absolute amplitude accuracy is not of utmost importance, and the throughput savings or convenience of not performing a Presel Center is desired. Presel Center is required prior to any measurement for best (and warranted) amplitude accuracy.

Agilent recommends that the Characterize Preselector operation be performed yearly as part of any calibration, but performing this operation every three months can be worthwhile.

Characterize Preselector immediately executes a characterization of the Preselector, which is a YIG-tuned filter (YTF). The instrument stops any measurement currently underway, performs the characterization, then restarts the measurement from the beginning (similar to pressing the Restart key).

The query form of the remote commands (:CALibration:YTF?) will invoke the alignment of the YTF subsystem and return a success or failure value.

A failure encountered during alignment will generate the Error Condition message “Characterize Preselector failure” and set bit 3 in the STATUS:QUESTIONable:CALibration:EXTended:FAILure status register. Successful completion of Characterize Preselector will clear this Condition. It will also begin the elapsed time counter for Last Characterize Preselector Time, and capture the Last Characterize Preselector Temperature.

The last Characterize Preselector Time and Temperature survives across the power cycle as this operation is performed infrequently.

NOTE The Characterize Preselector function can be interrupted by pressing the Cancel (ESC) front-panel key or remotely with Device Clear followed by the :ABORT SCPI command. None of the new characterization data is then used. However, since the old characterization data is purged at the beginning of the characterization, you now have an uncharacterized preselector. You should re-execute this function and allow it to finish before making any further preselected measurements.

Key Path	System, Alignments, Advanced
Mode	All
Remote Command	:CALibration:YTF :CALibration:YTF?
Example	:CAL:YTF
Notes	:CALibration:YTF? returns 0 if successful :CALibration:YTF? returns 1 if failed (including interfering user signal) While Advanced, Characterize Preselector is performing the alignment, bit 0 in the Status Operation register is set. Completion, or termination, will clear bit 0 in the Status Operation register. This command is sequential; it must complete before further SCPI commands are processed. Interrupting the alignment from remote is accomplished by invoking Device Clear followed by the :ABORT command. Successful completion will clear bit 9 in the Status Questionable Calibration register. A failure encountered during alignment will generate the Error Condition message “Characterize Preselector failed” and set bit 9 in the Status Questionable Calibration register. For Options that support frequencies > 3.6 GHz only.
Dependencies	This key does not appear in models that do not contain preselectors. In these models the SCPI command is accepted without error but no action is taken.
Couplings	Initializes the time for the Last Characterize Preselector Time. Records the temperature for the Last Characterize Preselector Temperature.

System Functions
System

Initial S/W Revision	Prior to A.02.00
----------------------	------------------

Timebase DAC

Allows control of the internal 10 MHz reference oscillator timebase. This may be used to adjust for minor frequency alignment between the signal and the internal frequency reference. This adjustment has no effect if the instrument is operating with an External Frequency Reference.

If the value of the Timebase DAC changes (by switching to Calibrated from User with User set to a different value, or in User with a new value entered) an alignment may be necessary. The alignment system will take appropriate action; which will either invoke an alignment or cause an Alert.

Key Path	System, Alignments
Mode	All
Remote Command	:CALibration:FREQuency:REFErence:MODE CALibrated USER :CALibration:FREQuency:REFErence:MODE?
Example	:CAL:FREQ:REF:MODE CAL
Notes	If the value of the timebase is changed the alignment system automatically performs an alignment or alerts that an alignment is due. If the value of the timebase is changed the alignment system automatically performs an alignment or alerts that an alignment is due.
Preset	This is unaffected by Preset but is set to CALibrated on a “Restore System Defaults->Align”.
State Saved	No
Initial S/W Revision	Prior to A.02.00

Calibrated

Sets the Timebase DAC to the value established during factory or field calibration. The value displayed on the menu key is the calibrated value.

Key Path	System, Alignments, Timebase DAC
Mode	All
Example	:CAL:FREQ:REF:MODE CAL
Readback Text	[xxx] < where xxx is the calibrated value
Initial S/W Revision	Prior to A.02.00

User

Allows setting the Timebase DAC to a value other than the value established during the factory or field calibration. The value displayed on the menu key is the calibrated value.

Key Path	System, Alignments, Timebase DAC
----------	---

Mode	All
Example	:CAL:FREQ:REF:MODE USER
Readback Text	xxx < where xxx is the Timebase DAC setting
Initial S/W Revision	Prior to A.02.00

Key Path	System, Alignments, Timebase DAC
Mode	All
Remote Command	:CALibration:FREQuency:REFerence:FINE <integer> :CALibration:FREQuency:REFerence:FINE?
Example	:CAL:FREQ:REF:FINE 8191
Notes	If the value of the timebase is changed the alignment system automatically performs an alignment or alerts that an alignment is due.
Couplings	Setting :CAL:FREQ:REF:FINE sets :CAL:FREQ:REF:MODE USER
Preset	This is unaffected by Preset but is set to the factory setting on a “Restore System Defaults->Align”.
State Saved	No
Min	0
Max	16383
Backwards Compatibility SCPI	:CALibration:FREQuency:REFerence:COARse ESA hardware contained two DAC controls for the Timebase. In X-Series the command :CALibration:FREQuency:REFerence:FINE is the method for adjusting the timebase. The :COARse command is provided as an alias to :FINE.
Initial S/W Revision	Prior to A.02.00

Remote Command	:CALibration:FREQuency:REFerence:COARse <integer> :CALibration:FREQuency:REFerence:COARse?
Example	:CAL:FREQ:REF:COAR 8191
Notes	This is an alias for CAL:FREQ:REF:FINE any change to COARse is reflected in FINE and vice-versa. See CAL:FREQ:REF:FINE for description of functionality.
Couplings	Setting :CAL:FREQ:REF:COAR sets :CAL:FREQ:REF:MODE USER
Initial S/W Revision	Prior to A.02.00

RF Preselector

This menu and all of its submenus are only available in models with the RF Preselector, such as the N9038A.

Align Now, 20 Hz to 30 MHz

Immediately executes an alignment of the receiver subsystem. The receiver will stop any measurement currently underway, perform the alignment, and then restart the measurement from the beginning (similar to pressing the Restart key).

The query form of the remote commands (:CALibration:RFPSelector:CONDUCTed?) will invoke the alignment of the RF Preselector on Conducted Band and return a success or failure value. Successful completion will clear the “Align 20 Hz to 30 MHz required” Error Condition, and clear the bit 1 in the Status Questionable Calibration Extended Needed register. The elapsed time counter will begin for Last Align Now, Conducted Time, and the temperature is captured for the Last Align Now, Conducted Temperature. The alignment can be interrupted by pressing the Cancel (ESC) front-panel key or remotely with Device Clear followed by the :ABORt SCPI command. When this occurs, the Error Condition “Align 20 Hz to 30 MHz required” is set because new alignment data may be employed for an individual subsystem, but not a cohesive set of data for all subsystems.

The “Align 20 Hz to 30 MHz required” Error Condition will appear when this alignment has expired. User is now responsible to perform the Align Now, 20 Hz to 30 MHz in order to keep the receiver in warranted operation. This alignment can only be performed by user as it is not part of the Auto Align process.

Key Path	System, Alignments, RF Preselector, Align Now
Mode	All
Remote Command	:CALibration:RFPSelector:CONDUCTed :CALibration:RFPSelector:CONDUCTed?
Example	:CAL:RFPS:COND
Notes	:CALibration:RFPSelector:CONDUCTed? Return 0 if successful :CALibration:RFPSelector:CONDUCTed? Return 1 if failed When Align 20 Hz to 30 MHz is performing the alignment, bit 0 in the Status Operation register is set. Completion, or termination, will clear bit 0 in the Status Operation register. This command is sequential; it must complete before further SCPI commands are processed. Interrupting the alignment from remote is accomplished by invoking Device Clear followed by the :ABORt command. Successful completion will clear bit 1 in the Status Questionable Calibration Extended Needed register and bit 0 in Status Questionable Calibration Extended Failure register. A failure encountered during alignment will set the Error Condition “20 Hz to 30 MHz Alignment Failure” and set both bit 1 in the Status Questionable Calibration Extended Needed register and bit 9 in Status Questionable Calibration register. For model N9038A only.
Dependencies	This key does not appear in other than N9038A models, setting or querying the SCPI will generate an error.

Couplings	Initializes the time for the Last Align Conducted Now, Conducted Time. Records the temperature for the Last Align Conducted Now, Conducted Temperature.
Status Bits/OPC Dependencies	Bit 8 or 9 may be set in the Status Questionable Calibration register. Bit 1 may be set in the Status Questionable Calibration Extended Needed register. Bit 0 may be set in the Status Questionable Calibration Extended Failure register.
Initial S/W Revision	A.08.00

Align Now, 30 MHz to 3.6 GHz

Immediately executes an alignment of the receiver subsystem. The receiver will stop any measurement currently underway, perform the alignment, and then restart the measurement from the beginning (similar to pressing the Restart key).

The query form of the remote commands (:CALibration:RFPSelector:RADiated?) will invoke the alignment of the RF Preselector on Radiated Band and return a success or failure value. Successful completion will clear the “Align 30 MHz to 3.6 GHz required” Error Condition, and clear the bit 2 in the Status Questionable Calibration Extended Needed register. The elapsed time counter will begin for Last Align Now, Radiated Time, and the temperature is captured for the Last Align Now, Radiated Temperature. The alignment can be interrupted by pressing the Cancel (ESC) front-panel key or remotely with Device Clear followed by the :ABORt SCPI command. When this occurs, the Error Condition “Align 30 MHz to 3.6 GHz required” is set because new alignment data may be employed for an individual subsystem, but not a cohesive set of data for all subsystems.

The “Align 30 MHz to 3.6 GHz required” Error Condition will appear when this alignment has expired. User is now responsible to perform the Align Now, 30 MHz to 3.6 GHz in order to keep the receiver in warranted operation. This alignment can only be performed by user as it is not part of the Auto Align process.

Key Path	System, Alignments, RF Preselector, Align Now
Mode	All
Remote Command	:CALibration:RFPSelector:RADiated :CALibration:RFPSelector:RADiated?
Example	:CAL:RFPS:RAD

Notes	<p>:CALibration:RFPSelector:RADiated? Return 0 if successful</p> <p>:CALibration:RFPSelector:RADiated? Return 1 if failed</p> <p>When Align 30 MHz to 3.6 GHz is performing the alignment, bit 0 in the Status Operation register is set. Completion, or termination, will clear bit 0 in the Status Operation register.</p> <p>This command is sequential; it must complete before further SCPI commands are processed. Interrupting the alignment from remote is accomplished by invoking Device Clear followed by the :ABORt command. Successful completion will clear bit 2 in the Status Questionable Calibration Extended Needed register and bit 1 in Status Questionable Calibration Extended Failure register.</p> <p>A failure encountered during alignment will set the Error Condition “30 MHz to 3.6 GHz Alignment Failure” and set both bit 2 in the Status Questionable Calibration Extended Needed register and bit 9 in Status Questionable Calibration register.</p> <p>For model N9038A only.</p>
Dependencies	<p>This key does not appear in other than N9038A models, setting or querying the SCPI will generate an error.</p>
Couplings	<p>Initializes the time for the Last Align Radiated Now, Radiated Time.</p> <p>Records the temperature for the Last Align Radiated Now, Radiated Temperature.</p>
Status Bits/OPC Dependencies	<p>Bit 8 or 9 may be set in the Status Questionable Calibration register.</p> <p>Bit 2 may be set in the Status Questionable Calibration Extended Needed register.</p> <p>Bit 1 may be set in the Status Questionable Calibration Extended Failure register.</p>
Initial S/W Revision	<p>A.08.00</p>

Align Now, 20 Hz to 3.6 GHz

Immediately executes an alignment of the receiver subsystem. The receiver will stop any measurement currently underway, perform the alignment, and then restart the measurement from the beginning (similar to pressing the Restart key).

The query form of the remote commands (:CALibration:RFPSelector:FULL?) will invoke the alignment of the RF Preselector on both Conducted and Radiated Band and return a success or failure value. Successful completion will clear the “Align 20 Hz to 3.6 GHz required” Error Condition, and clear the bit 1 and bit 2 in the Status Questionable Calibration Extended Needed register. The elapsed time counter will begin for Last Align Now, Conducted Time and Last Align Now Radiated Time and the temperature is captured for Last Align Now, Conducted Temperature and Last Align Now, Radiated Temperature. The alignment can be interrupted by pressing the Cancel (ESC) front-panel key or remotely with Device Clear followed by the :ABORt SCPI command. When this occurs, the Error Condition “Align 20 Hz to 3.6 GHz required” is set because new alignment data may be employed for an individual subsystem, but not a cohesive set of data for all subsystems.

The “Align 20 Hz to 3.6 GHz required” Error Condition will appear when this alignment has expired. User is now responsible to perform the Align Now, 20 Hz to 3.6 GHz in order to keep the receiver in warranted operation. This alignment can only be performed by user as it is not part of the Auto Align process.

Key Path	System, Alignments, RF Preselector, Align Now
Mode	All
Remote Command	:CALibration:RFPSelector:FULL :CALibration:RFPSelector:FULL?
Example	:CAL:RFPS:FULL
Notes	:CALibration:RFPSelector:FULL? Return 0 if successful :CALibration:RFPSelector:FULL? Return 1 if failed When Align 20 Hz to 3.6 GHz is performing the alignment, bit 0 in the Status Operation register is set. Completion, or termination, will clear bit 0 in the Status Operation register. This command is sequential; it must complete before further SCPI commands are processed. Interrupting the alignment from remote is accomplished by invoking Device Clear followed by the :ABORT command. Successful completion will clear bit 1, bit 2 in the Status Questionable Calibration Extended Needed register and bit 0, bit 1 in Status Questionable Calibration Extended Failure register. A failure encountered during alignment will set the Error Condition “20 Hz to 3.6 GHz Alignment Failure” and set bit 1, bit 2 in the Status Questionable Calibration Extended Needed register and bit 9 in Status Questionable Calibration register. For model N9038A only.
Dependencies	This key does not appear in other than N9038A models, setting or querying the SCPI will generate an error.
Couplings	Initializes the time for the Last Align Conducted Now, Conducted Time. Initializes the time for the Last Align Radiated Now, Radiated Time. Records the temperature for the Last Align Conducted Now, Conducted Temperature. Records the temperature for the Last Align Radiated Now, Radiated Temperature.
Status Bits/OPC Dependencies	Bit 8 or 9 may be set in the Status Questionable Calibration register. Bit 1 and 2 may be set in the Status Questionable Calibration Extended Needed register. Bit 0 and 1 may be set in the Status Questionable Calibration Extended Failure register.
Initial S/W Revision	A.08.00

Alert

Setting Alert to ON/OFF will enable/disable the display of RF Preselector alignment required message on the status line. The instrument will power up with Alert On mode.

Key Path	System, Alignments, RF Preselector
Mode	All
Remote Command	:CALibration:RFPSelector:ALERT ON OFF 0 1 :CALibration:RFPSelector:ALERT?
Example	:CAL:RFPS:ALER OFF
Notes	For model N9038A only. Error Condition will be generated when the alert is On and any of the RF Preselector alignments has expired.
Preset	This is unaffected by Preset, but is set to ON on a “Restore System Defaults->Align”.
State Saved	No
Initial S/W Revision	A.08.00

Schedule Setup

To schedule a task to run automatically at the background based on the recurrence and time set in the scheduler. Make sure that the Instrument’s local time is accurate as the Scheduler relies on this information to execute the task.

Key Path	System, Alignments, RF Preselector
Initial S/W Revision	A.08.00

Task

There is Task 1 to 3 to be selected for the scheduler to run. Task 1 is the 20 Hz to 30 MHz alignment, Task 2 is the 30 MHz to 3.6 GHz alignment and Task 3 is the 20 Hz to 3.6 GHz alignment.

Key Path	System, Alignments, RF Preselector, Schedule Setup
Mode	All
Remote Command	:CALibration:RFPSelector:SCHeduler:TASK T1 T2 T3 :CALibration:RFPSelector:SCHeduler:TASK?
Example	:CAL:RFPS:SCH:TASK T1
Notes	Changing the task will not reset the Scheduler time and the alignment is based on the current scheduled configuration to occur. For model N9038A only.

Preset	This is unaffected by Preset but is set to T3 on a “Restore System Defaults->Align”.
State Saved	No
Range	Task 1 Task 2 Task 3
Initial S/W Revision	A.08.00

Date/Time

Configure the scheduler to run a task starting from this date and time. The date and time rely on the instrument’s local time to execute a scheduled task. The date is based on the format “YYYY/MM/DD” and the time is based on a 24 hour clock.

Key Path	System, Alignments, RF Preselector, Schedule Setup
Mode	All
Remote Command	:CALibration:RFPSelector:SCHEduler:TIME:START "date", "time" :CALibration:RFPSelector:SCHEduler:TIME:START? This query returns data using the following format "YYYY/MM/DD; HH:MM:SS"
Example	:CAL:RFPS:SCH:TIME:STAR "2009/8/20", "12:00:00"
Notes	“date” is representation of the date the task will run in the form of “YYYY/MM/DD” where: YYYY is the four digit representation of year. (for example, 2009) MM is the two digit representation of month. (for example, 01 to 12) DD is the two digit representation of the day. (for example, 01 to 28, 29, 30 or 31 depending on the month and year) “time” is a representation of the time of day the task will run in the form of “HH:MM:SS” where: HH is the two digit representation of the hour in 24 hour format MM is the two digit representation of minute SS is the two digit representation of seconds For model N9038A only.
Preset	This is unaffected by Preset but is set to Current date and 00:00:00 on a “Restore System Defaults->Align”.
State Saved	No
Initial S/W Revision	A.08.00

Date

Configure the date of the scheduled task. The SCPI command to configure the date and time parameters of the

System Functions System

scheduler is the same; however, they each have their own front panel control.

Key Path	System, Alignments, RF Preselector, Schedule Setup, Date/Time
Notes	See “Date/Time ” on page 277 . For model N9038A only.
Preset	This is unaffected by Preset but is set to Current date and 00:00:00 on a “Restore System Defaults->Align”.
State Saved	No
Initial S/W Revision	A.08.00

Time

Configure the time of the scheduled task. The SCPI command to configure the date and time parameters of the scheduler is the same; however, they each have their own front panel control.

Key Path	System, Alignments, RF Preselector, Schedule Setup, Date/Time
Notes	See “Date/Time ” on page 277 . For model N9038A only.
Preset	This is unaffected by Preset but is set to Current date and 00:00:00 on a “Restore System Defaults->Align”.
State Saved	No
Initial S/W Revision	A.08.00

Recurrence

Configure the scheduler to run the task recurrently on a scheduled date and time. You can schedule it to run daily, weekly or alternate weeks.

Key Path	System, Alignments, RF Preselector, Schedule Setup
Mode	All
Remote Command	:CALibration:RFPSelector:SCHeDuler:RECurrence DAY WEEK OFF :CALibration:RFPSelector:SCHeDuler:RECurrence?
Example	:CAL:RFPS:SCH:REC DAY
Notes	For model N9038A only.
Preset	This is unaffected by Preset but is set to OFF on a “Restore System Defaults->Align”.
State Saved	No
Range	DAY WEEK OFF
Initial S/W Revision	A.08.00

Every N Weeks

Configure the scheduler to run the task on a day in every number of week's duration.

Key Path	System, Alignments, RF Preselector, Schedule Setup, Recurrence
Initial S/W Revision	A.08.00

N of Weeks

Set the number of week's duration the scheduler will trigger a task.

Key Path	System, Alignments, RF Preselector, Schedule Setup, Recurrence, Every N Weeks
Mode	All
Remote Command	:CALibration:RFPSelector:SCHeuler:RECurrence:WEEK <integer> :CALibration:RFPSelector:SCHeuler:RECurrence:WEEK?
Example	:CAL:RFPS:SCH:REC:WEEK 2
Notes	New scheduled date to run the alignment task will get updated when this parameter is changed. For model N9038A only.
Preset	This is unaffected by Preset but is set to 1 on a "Restore System Defaults->Align".
State Saved	No
Range	1-52
Initial S/W Revision	A.08.00

Day

Set the Day of the Week the scheduler will run a scheduled task.

Key Path	System, Alignments, RF Preselector, Schedule Setup, Recurrence, Every N Weeks
Mode	All
Remote Command	:CALibration:RFPSelector:SCHeuler:RECurrence:DAY SUN MON TUE WED THU FRI SAT :CALibration:RFPSelector:SCHeuler:RECurrence:DAY?
Example	:CAL:RFPS:SCH:REC:DAY SUN
Notes	For model N9038A only.
Preset	This is unaffected by Preset but is set to SUN on a "Restore System Defaults->Align".
State Saved	No

System Functions

System

Range	Sunday Monday Tuesday Wednesday Thursday Friday Saturday
Initial S/W Revision	A.08.00

Scheduler

Setting the Scheduler to ON will trigger the execution of the scheduled task based on the recurrence and time set in the scheduler since the last successful of the specific alignment. A warning condition of “RF Preselector alignment scheduler is ON” will be appeared when the scheduler is set to ON. OFF will turn off the Scheduler from running any scheduled task.

Key Path	System, Alignments, RF Preselector
Mode	All
Remote Command	:CALibration:RFPSelector:SchEduler:STATe ON OFF 0 1 :CALibration:RFPSelector:SchEduler:STATe?
Example	:CAL:RFPs:SCH:STAT OFF
Notes	For model N9038A only.
Preset	This is unaffected by Preset but is set to OFF on a “Restore System Defaults->Align”.
State Saved	No
Initial S/W Revision	A.08.00

Restore Defaults

Provides incremental initialization of the system setting groups along with supporting a comprehensive reset of the entire instrument back to a factory default state. The menu selections are the groups of system settings and when one is selected, that particular group of system settings is reset back to their default values.

Key Path	System
Mode	All
Remote Command	:SYSTem:DEFault [ALL] ALIGn INPut MISC MODes PON
Example	SYST:DEF
State Saved	No
Initial S/W Revision	Prior to A.02.00

Restore Input/Output Defaults

Causes the group of settings and data associated with Input/Output front-panel key to be a reset to their default values. This level of Restore System Defaults does not affect any other system settings, mode settings and does not cause a mode switch. .

Confirmation is required to restore the Input/Output setting. The confirmation dialog is:

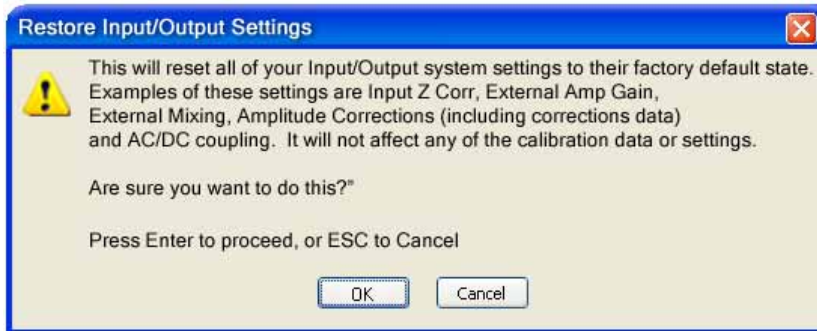

Key Path	System, Restore System Defaults
Example	:SYST:DEF INP
Initial S/W Revision	Prior to A.02.00

Restore Power On Defaults

This selection causes the Power On settings to be a reset to their default value. This level of Restore System Defaults does not affect any other system settings, mode settings and does not cause a mode switch. The Power On settings and their default values are Power On Type reset to Mode and Input/Output Defaults and Power On Application reset to whatever the factory set as its default value.

Confirmation is required to restore the factory default values. The confirmation dialog is:

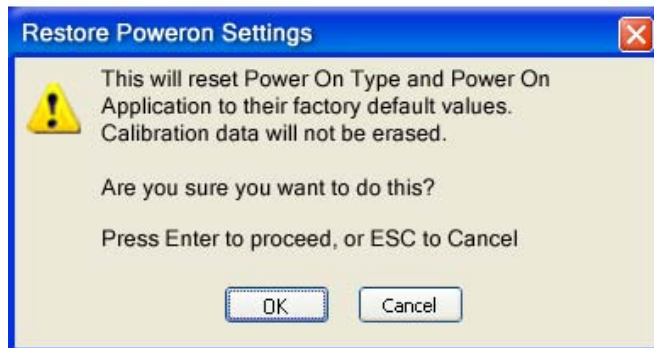

Key Path	System, Restore System Defaults
Example	:SYST:DEF PON
Initial S/W Revision	Prior to A.02.00

Restore Align Defaults

This selection causes the Alignment system settings to be a reset to their default values. This does not affect any Alignment data stored in the system. This level of Restore System Defaults does not affect any other system settings, mode settings and does not cause a mode switch.

System Functions

System

After performing this function, it may impact the auto-alignment time of the instrument until a new alignment baseline has been established.

Confirmation is required to restore the factory default values. The confirmation dialog is:

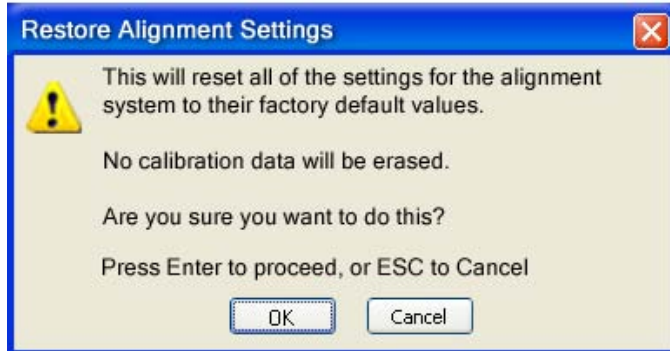

Key Path	System, Restore System Defaults
Example	:SYST:DEF ALIG
Initial S/W Revision	Prior to A.02.00

Restore Misc Defaults

This selection causes miscellaneous system settings to be reset to their default values. With this reset, you lose the GPIB address and it is reset to 18, so this should be used with caution. This level of Restore System Defaults does not affect any other system settings, mode settings and does not cause a mode switch. This miscellaneous group contains the rest of the settings that have not been part of the other Restore System Defaults groups. The following table is a complete list of settings associated with this group:

Miscellaneous Setting	Default Value
Verbose SCPI	Off
GPIB Address	18
Auto File Name Number	000
Save Type	State
State Save To	Register 1
Screen Save To	SCREEN000.png
DISP:ENABle	ON
Full Screen	Off
SCPI Telnet	ON
SCPI Socket	ON
SICL Server	ON

Display Intensity	100
Display Backlight	ON
Display Theme	TDColor
System Annotation	ON
The SYST:PRES:TYPE	MODE

Confirmation is required to restore the factory default values. The confirmation dialog is:

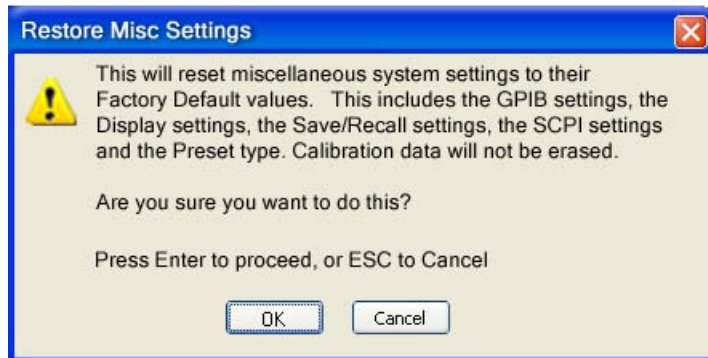

Key Path	System, Restore System Defaults
Example	:SYST:DEF MISC
Initial S/W Revision	Prior to A.02.00

Restore Mode Defaults (All Modes)

This selection resets all of the modes in the instrument back to their default state just as a Restore Mode Defaults does and it switches the instrument to the power-on mode and causes the default measurement for the power-on mode to be active. This level of Restore System Defaults does not affect any system settings, but it does affect the state of all modes and does cause a mode switch unless the instrument was already in the power-on mode.

Confirmation is required to restore the factory default values. The confirmation dialog is:

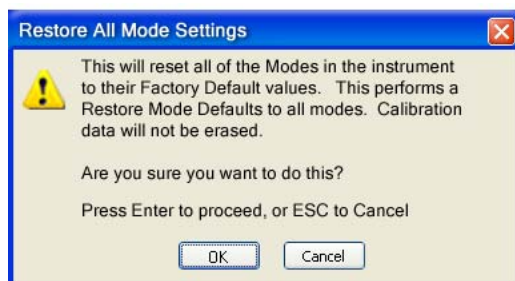

Key Path	System, Restore System Defaults
----------	--

System Functions
System

Example	:SYST:DEF MOD
Couplings	An All Mode will cause the currently running measurement to be aborted, mode switch to the power-on mode and activate the default measurement for the power-on mode.. It gets the mode to a consistent state with all of the default couplings set.
Initial S/W Revision	Prior to A.02.00

All

This is the catastrophic function that does a comprehensive reset of ALL analyzer settings to their factory default values. It resets all of the system setting groups, causes a Restore Mode Defaults for all modes in the instrument, and switches back to the power-on mode. It does not affect the User Preset file or any user saved files.

Confirmation is required to restore the factory default values. The confirmation dialog is:

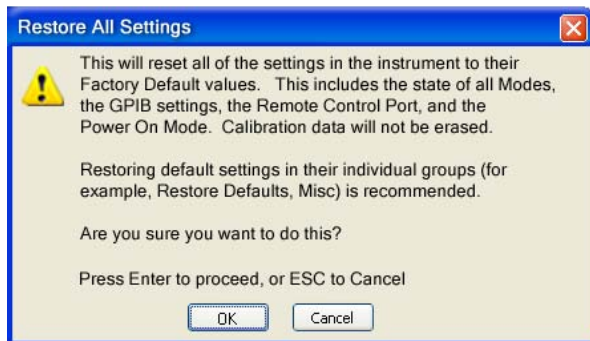

Key Path	System, Restore System Defaults
Example	:SYST:DEF ALL
Couplings	An All will cause the currently running measurement to be aborted and get all modes to a consistent state, so it is unnecessary to couple any settings.
Initial S/W Revision	Prior to A.02.00

Control Panel...

Opens the Windows Control Panel. The Control Panel is used to configure certain elements of Windows that are not configured through the hardkey/softkey System menus.

The Control Panel is a separate Windows application, so to return to the analyzer once you are in the Control Panel, you may either:

Exit the Control Panel by clicking on the red X in the upper right hand corner, with a mouse

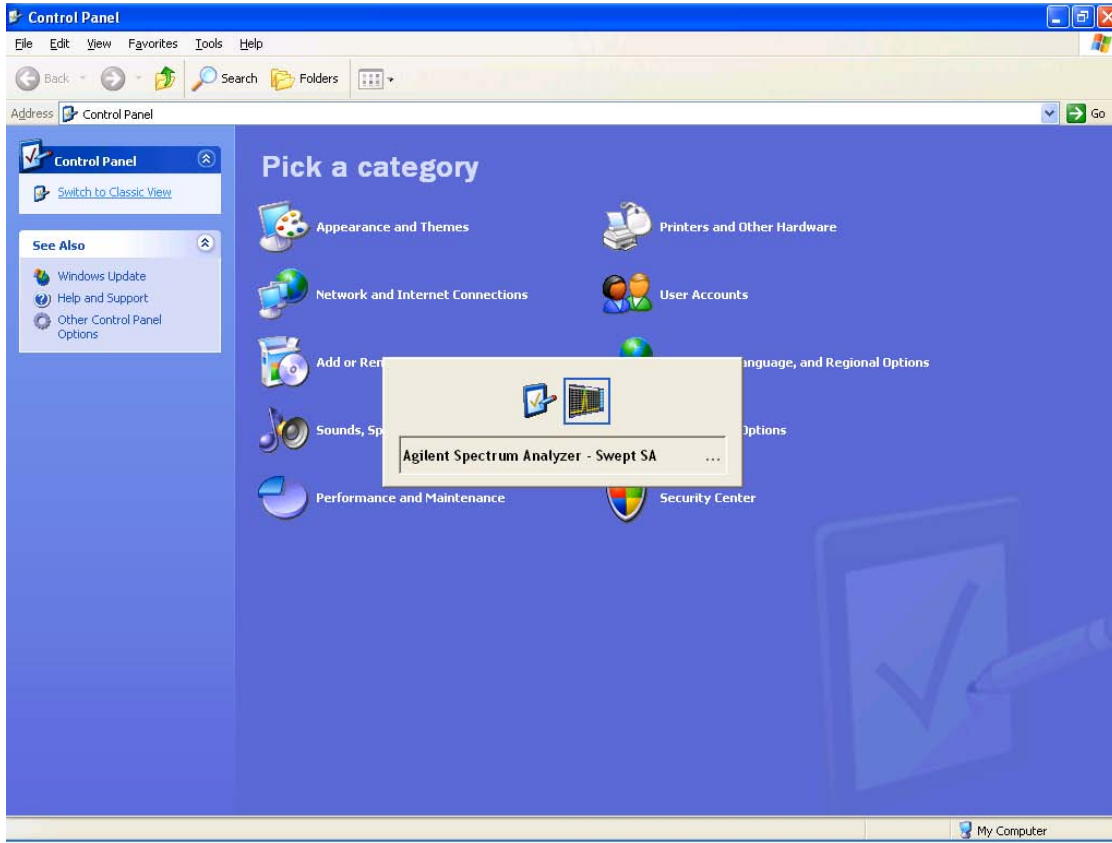

Or use Alt-Tab: press and hold the Alt key and press and release the Tab key until the Analyzer logo is showing in the window in the center of the screen, as above, then release the Alt key.

Key Path	System
Notes	No remote command for this key.
Initial S/W Revision	Prior to A.02.00

Licensing...

Opens the license explorer.

For Help on this key, select Help in the menu bar at the top of the license explorer window.

Key Path	System
Notes	No equivalent remote command for this key.

System Functions
System

Backwards Compatibility Notes	In ESA the SCPI command for displaying the Show Licenses screen is: :SYSTem:CONFIgure:LKEY:STATe OFF ON 0 1 :SYSTem:CONFIgure:LKEY:STATe? There are no equivalent SCPI commands in the X-Series for displaying the License Explorer.
Initial S/W Revision	Prior to A.02.00

Remote Command	:SYSTem:LKEY <"OptionInfo">, <"LicenseInfo">
Example	SYST:LKEY "N9073A-1FP","027253AD27F83CDA5673A9BA5F427FDA5E4F25AEB1017638211AC9F60D9C639FE539735909C551DE0A91"
Notes	The <"OptionInfo"> contains the feature and the version. You must specify the feature but can omit the version. If you omit the version, the system regards it as the latest one, since the system knows which version is supported for each feature. The <"LicenseInfo"> contains the signature, the expiration date, and serial number for transport if transportable. You must specify the signature, but you can omit the other information. If you omit the expiration date, the system regards it as permanent. If you omit the serial number, the system regards it as non-transportable. As a result, this supports reverse compatibility.
Initial S/W Revision	Prior to A.02.00

Remote Command	:SYSTem:LKEY:DELeTe <"OptionInfo">, <"LicenseInfo">
Example	SYST:LKEY:DEL "N9073A-1FP","027253AD27F83CDA5673A9BA5F427FDA5E4F25AEB1017638211AC9F60D9C639FE539735909C551DE0A91"
Notes	The <"OptionInfo"> contains the feature and the version. You must specify the feature but can omit the version. If you omit the version, the system regards it as the latest one, if more than one version is installed. The <"LicenseInfo"> contains the signature, the expiration date, and whether or not be transportable. You must specify the signature, but you can omit the other information. If you omit the expiration date, the system regards it as permanent. If you omit the transportability, the system regards it as non-transportable. As a result, this supports reverse compatibility.
Initial S/W Revision	Prior to A.02.00

Remote Command	:SYSTem:LKEY:LIST?
-----------------------	--------------------

Notes	<p>Return Value:</p> <p>An <arbitrary block data> of all the installed instrument licenses.</p> <p>The format of each license is as follows.</p> <p><Feature>,<Version>,<Signature>,<Expiration Date>,<Serial Number for Transport></p> <p>Return Value Example:</p> <p>#3136</p> <p>N9073A-1FP,1.000,B043920A51CA</p> <p>N9060A-2FP,1.000,4D1D1164BE64</p> <p>N9020A-508,1.000,389BC042F920</p> <p>N9073A-1F1,1.000,5D71E9BA814C,13-aug-2005</p> <p><arbitrary block data> is:</p> <p>#NMMM<data></p> <p>Where:</p> <p>N is the number of digits that describes the number of MMM characters. For example if the data was 55 bytes, N would be 2.</p> <p>MMM would be the ASCII representation of the number of bytes. In the previous example, N would be 55.</p> <p><data> ASCII contents of the data</p>
Initial S/W Revision	Prior to A.02.00

Remote Command	:SYSTem:LKEY? <"OptionInfo">
Example	SYST:LKEY? "N9073A-1FP"
Notes	<p>The <"OptionInfo"> contains the feature and the version. You must specify the feature but can omit the version. If you omit the version, the system regards it as the latest one.</p> <p>Return Value:</p> <p><"LicenseInfo"> if the license is valid, null otherwise.</p> <p><"LicenseInfo"> contains the signature, the expiration date, and serial number if transportable.</p> <p>Return Value Example:</p> <p>"B043920A51CA"</p>
Initial S/W Revision	Prior to A.02.00

Remote Command	:SYSTem:HID?
Notes	Return value is the host ID as a string
Initial S/W Revision	Prior to A.02.00

Security

Accesses capabilities for operating the instrument in a security controlled environment.

Key Path	System
Initial S/W Revision	A.04.00

USB

The Windows operating system can be configured to disable write access to the USB ports for users who are in a secure environment where transferring data from the instrument is prohibited. This user interface is a convenient way for the customer to disable write access to USB.

Key Path	System, Security
Mode	All
Scope	Mode Global
Remote Command	:SYSTem:SECurity:USB:WPRotect[:ENABLE] ON OFF 0 1 :SYSTem:SECurity:USB:WPRotect[:ENABLE]?
Example	:SYST:SEC:USB:WPR ON Will set USB ports to Read-only
Notes	When the USB ports are in Read-only mode then no data can be stored to USB, including the internal USB memory used for a back-up location for the calibration data.
Dependencies	This key is grayed-out unless the current user has administrator privileges.
Preset	This is unaffected by Preset or any Restore System Defaults. An Agilent Recovery will set the USB to write protect OFF
State Saved	No
Range	Read-Write Read only
Initial S/W Revision	A.04.00

Read-Write

Selection for allowing full read-write access to the USB ports.

Key Path	System, Security, USB
Example	:SYST:SEC:USB:WPR OFF Will set USB ports to Read-Write
Initial S/W Revision	A.04.00

Read only

Selection for disabling write access to the USB ports.

Key Path	System, Security, USB
----------	------------------------------

Example	:SYST:SEC:USB:WPR ON Will set USB ports to Read only
Initial S/W Revision	A.04.00

Diagnostics

RF Preselector

This menu provides the ability to switch to the particular filter in the Conducted or Radiated Band in order to see the frequency response of the specific RF Preselector filter. The Conducted band has 13 fixed filters and Radiated band has 6 tunable filters and 1 fixed filter. The tunable filters will be characterized during the Factory Calibration test by executing the Characterize RF Preselector, All Bands button. Once after the filter is characterized, the amplitude correction for the RF Preselector path will be invalid and the receiver needs to go through the Factory Flatness calibration tests for the RF Preselector Path. The internal Calibrators for RF Preselector consists of DDS (Direct Digital Synthesizer) and Noise Source. The DDS operating range is from DC to 60 MHz whereas Noise Source is from 10 MHz to 4 GHz. Both the calibrators are used by the firmware to execute the RF Preselector System alignment to improve the amplitude variation of the RF Preselector path.

The Diagnostics key in the System menu gives you access to basic diagnostic capabilities of the instrument.

Key Path	System
Initial S/W Revision	Prior to A.02.00

Show Hardware Statistics

Provides a display of various hardware statistics. The statistics include the following:

- Mechanical relay cycles
- High and Low temperature extremes
- Elapsed time that the instrument has been powered-on (odometer)

The display should appear listing the statistics, product number, serial number, and firmware revision.

System Functions
System

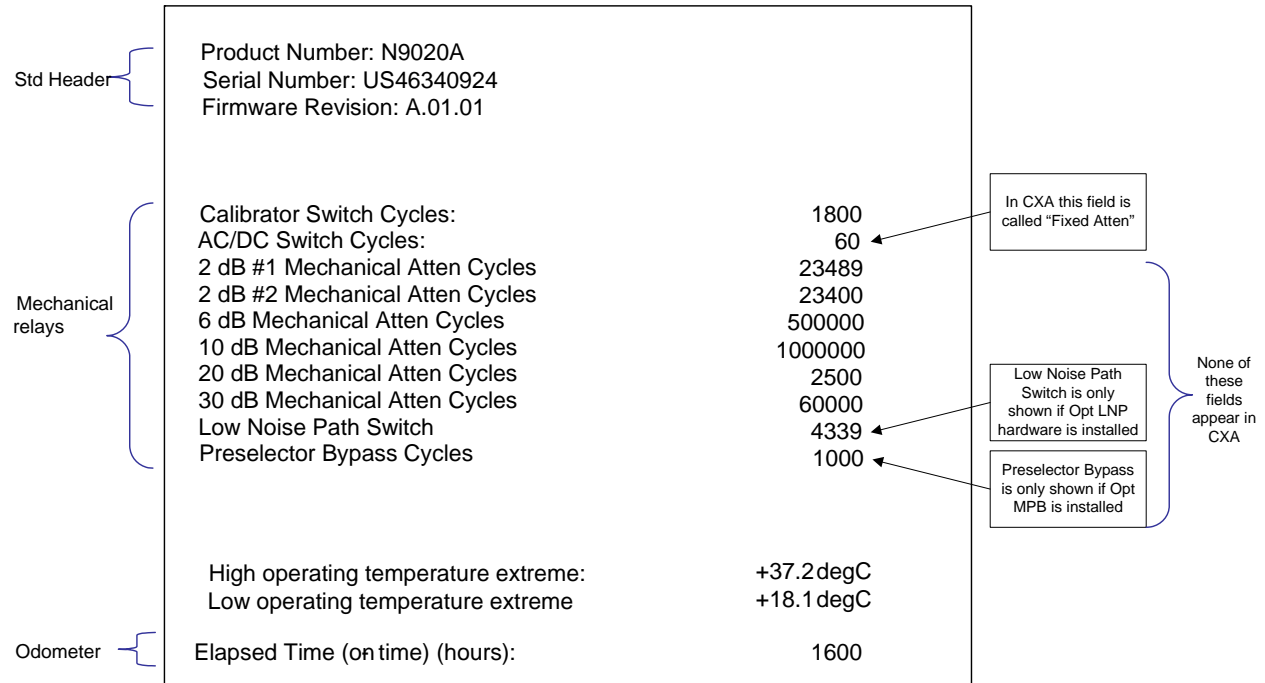

The data will be updated only when the Show Hardware Statistics menu key is pressed, it will not be updated while the screen is displayed.

The tabular data should be directly printable.

Key Path	System, Diagnostics
Mode	All
Notes	The values displayed on the screen are only updated upon entry to the screen and not updated while the screen is being displayed.
Initial S/W Revision	Prior to A.02.00

SCPI for Show Hardware Statistics (Remote Commands Only)

Each of the hardware statistic items can be queried via SCPI.

- “Query the Mechanical Relay Cycle Count” on page 290
- “Query the Operating Temperature Extremes” on page 291
- “Query the Elapsed Time since 1st power on” on page 291

Query the Mechanical Relay Cycle Count

Returns the count of mechanical relay cycles.

Remote Command	:SYSTem:MRELay:COUNT?
Example	:SYST:MREL:COUN?

Notes	<p>Query Only</p> <p>The return value is a comma separated list of the individual counts for each mechanical relay.</p> <p>The position of the relays in the list is: “<Cal Signal>,<AC/DC>,<2dB #1 Atten>,<2dB #2 Atten>,<6dB Atten>,<10dB Atten>,<20dB Atten>,<30dB Atten>,<Fixed Atten>,<Low Noise Path Switch>,<Presel Bypass>”</p> <p>Items in the list not pertaining to your particular hardware configuration will return as -999 for those items.</p>
Initial S/W Revision	Prior to A.02.00
Modified at S/W Revision	A.03.00, A.04.00

Query the Operating Temperature Extremes

Returns the low operating temperature extreme value. The value survives a power-cycle and is the temperature extreme encountered since the value was reset by the factory or service center.

Mode	All
Remote Command	:SYSTem:TEMPerature:LEXTreme?
Example	:SYST:TEMP:LEXT?
Notes	Value is in degrees Celsius at which the lowest operating temperature has been recorded since 1st power-up.
State Saved	No
Initial S/W Revision	Prior to A.02.00

Mode	All
Remote Command	:SYSTem:TEMPerature:HEXTreme?
Example	:SYST:TEMP:HEXT?
Notes	Value is in degrees Celsius at which the highest operating temperature has been recorded since 1st power-up.
State Saved	No
Initial S/W Revision	Prior to A.02.00

Query the Elapsed Time since 1st power on

Returns the elapsed on-time in minutes since 1st power-on.

Remote Command	:SYSTem:PON:ETIMe?
Example	:SYST:PON:ETIM?
Notes	Query Only

System Functions
System

Initial S/W Revision	Prior to A.02.00
----------------------	------------------

Advanced

Accesses advanced diagnostic capabilities performed in the factory or under instructions from repair procedures. This menu key is only visible when the logged-in user is “saservice”. The first access to the Advanced Diagnostic Menu after invoking the instrument application will require an authentication, which is to enter the Service Code. Subsequent accesses to the Advanced Diagnostic Menu are unimpeded. The Authentication dialog looks like:



“OK” is the default key thus the Enter key is used to complete the entry. If invalid Service Code is entered authentication is not granted and you are provided the following dialog:



Key Path	System, Diagnostics
Notes	Password is required to access this menu.
Initial S/W Revision	Prior to A.02.00

	Agilent Converged	PSA
IP Address	SYSTem:COMMunicate:LAN:ADDRess <string> SYSTem:COMMunicate:LAN:ADDRess?	:SYSTem:COMMunicate:LAN[:SELF]:IP <string> :SYSTem:COMMunicate:LAN[:SELF]:IP?
Gateway	SYSTem:COMMunicate:LAN:DGATeway <string> SYSTem:COMMunicate:LAN:DGATeway?	:SYSTem:COMMunicate:LAN[:SELF]:GATEway <string> :SYSTem:COMMunicate:LAN[:SELF]:GATEway?
Subnet Mask	SYSTem:COMMunicate:LAN:SMASk <string> SYSTem:COMMunicate:LAN:SMASk?	:SYSTem:COMMunicate:LAN[:SELF]:SUBNetmask <string> :SYSTem:COMMunicate:LAN[:SELF]:SUBNetmask?

Service

Accesses capabilities performed in the factory or under instructions from repair procedures. This menu key is only visible when the logged-in user is “advanceduser” or “saservice”. The first access to the Service Menu after invoking the instrument application will require an authentication Service Code.

Key Path	System
Initial S/W Revision	Prior to A.02.00

Internet Explorer...

This key launches Microsoft Internet Explorer. A mouse and external keyboard are highly desired for using Internet Explorer. When Internet Explorer is running, close Internet Explorer to return focus to the Instrument Application (or use Alt-Tab).

Key Path	System
Mode	All
Notes	No equivalent remote command for this key.
Initial S/W Revision	A.05.01

System Remote Commands (Remote Commands Only)

The commands in this section have no front panel key equivalent

Initial S/W Revision	Prior to A.02.00
----------------------	------------------

System Powerdown (Remote Command Only)

Remote Command	SYSTem:PDOWn [NORMal FORCe]
Notes	Shuts down the instrument in the normal way (NORMal) or forced way (FORCe). In case there is another application with modified data pending for saving, the application prompt the user. The system waits until the user responds in the normal mode. It will go off after 20 seconds of wait in the force mode and all data will be lost.

List installed Options (Remote Command Only)

Lists the installed options that pertain to the instrument (signal analyzer) .

Mode	All
Remote Command	:SYSTem:OPTions?
Example	:SYST:OPT?

Notes	The return string is a comma separated list of the installed options. For example: “503,P03,PFR” :SYSTem:OPTions? and *OPT? are the same.
State Saved	No
Initial S/W Revision	Prior to A.02.00

Lock the Front-panel keys (Remote Command Only)

Disables the instrument keyboard to prevent local input when the instrument is controlled remotely. Annunciation showing a “K” for ‘Klock’ (keyboard lock) alerts the local user that the keyboard is locked. Klock is similar to the GPIB Local Lockout function; namely that no front-panel keys are active with the exception of the Power Standby key. (The instrument is allowed to be turned-off if Klock is ON.) The Klock command is used in remote control situations where Local Lockout cannot be used.

Although primary intent of Klock is to lock-out the front panel, it will lock-out externally connected keyboards through USB. Klock has no effect on externally connected pointing devices (mice).

The front panel ‘Local’ key (Cancel/Esc) has no effect if Klock is ON.

Mode	All
Remote Command	:SYSTem:KLOCK OFF ON 0 1 :SYSTem:KLOCK?
Example	:SYST:KLOC ON
Notes	Keyboard lock remains in effect until turned-off or the instrument is power-cycled
Preset	Initialized to OFF at startup, unaffected by Preset
State Saved	No
Initial S/W Revision	Prior to A.02.00

List SCPI Commands (Remote Command Only)

Outputs a list of the valid SCPI commands for the currently selected Mode.

Remote Command	:SYSTem:HELP:HEADers?
Example	:SYST:HELP:HEAD?
Notes	The output is an IEEE Block format with each command separated with the New-Line character (hex 0x0A)
Initial S/W Revision	Prior to A.02.00

SCPI Version Query (Remote Command Only)

Returns the SCPI version number with which the instrument complies. The SCPI industry standard

changes regularly. This command indicates the version used when the instrument SCPI commands were defined.

Remote Command	:SYSTem:VERsion?
Example	:SYST:VERS?
Initial S/W Revision	Prior to A.02.00

Date (Remote Command Only)

The recommended access to the Date, Time, and Time zone of the instrument is through the Windows native control (Control Panel or accessing the Task Bar). You may also access this information remotely, as shown in this command and Time (below).

Sets or queries the date in the instrument.

Mode	All
Remote Command	:SYSTem:DATE "<year> , <month> , <day>" :SYSTem:DATE?
Example	:SYST:DATE "2006,05,26"
Notes	<year> is the four digit representation of year. (for example, 2006) <month> is the two digit representation of year. (for example. 01 to 12) <day> is the two digit representation of day. (for example, 01 to 28, 29, 30, or 31) depending on the month and year
Initial S/W Revision	Prior to A.02.00

Time (Remote Command Only)

Sets or queries the time in the instrument.

Mode	All
Remote Command	:SYSTem:TIME "<hour> , <minute> , <second>" :SYSTem:TIME?
Example	:SYST:TIME "13,05,26"
Notes	<hour> is the two digit representation of the hour in 24 hour format <minute> is the two digit representation of minute <second> is the two digit representation of second
Initial S/W Revision	Prior to A.02.00

I/O Config

Activates a menu for identifying and changing the I/O configuration for remote control.

Key Path	System
Initial S/W Revision	Prior to A.02.00

GPIB

Activates a menu for configuring the GPIB I/O port.

Key Path	System, I/O Config
Initial S/W Revision	A.02.00

GPIB Address

Select the GPIB remote address.

Key Path	System, I/O Config, GPIB
Mode	All
Remote Command	:SYSTem:COMMunicate:GPIB[1][:SELF]:ADDRESS <integer> :SYSTem:COMMunicate:GPIB[1][:SELF]:ADDRESS?
Example	:SYST:COMM:GPIB:ADDR 17
Notes	Changing the Address on the GPIB port requires all further communication to use the new address.
Preset	This is unaffected by Preset but is set to 18 on a "Restore System Defaults->Misc"
State Saved	No
Range	0 to 30
Initial S/W Revision	Prior to A.02.00

GPIB Controller

Sets the GPIB port into controller or device mode. In the normal state, GPIB controller is disabled, which allows the analyzer to be controlled by a remote computer. When GPIB Controller is enabled, the instrument can run software applications that use the instrument's computer as a GPIB controller; controlling devices connected to the instrument's GPIB port.

NOTE When GPIB Controller is enabled, the analyzer application itself cannot be controlled over GPIB. In this case it can easily be controlled via LAN or USB. The GPIB port cannot be a controller and device at the same time. Only one controller can be active on the GPIB bus at any given time. If the analyzer is the controller, an external PC cannot be a controller.

To control the instrument from the software that is performing GPIB controller operation, you can use an internal TCP/IP connection to the analyzer application. Use the address TCPIP0:localhost:inst0:INSTR to send SCPI commands to the analyzer application.

Key Path	System, I/O Config, GPIB
Mode	All
Scope	Mode Global
Remote Command	:SYSTem:COMMunicate:GPIB[1][:SELF]:CONTroller[:ENABle] ON OFF 0 1 :SYSTem:COMMunicate:GPIB[1][:SELF]:CONTroller[:ENABle]?
Example	:SYST:COMM:GPIB:CONT ON Will set GPIB port to Controller
Notes	When the instrument becomes the Controller bit 0 in the Standard Event Status Register is set (and when the instrument relinquishes Controller capability bit 0 is cleared in the Standard Event Status Register).
Preset	This is unaffected by Preset but is set to OFF on a “Restore System Defaults->Misc”
State Saved	No
Range	Disabled Enabled
Initial S/W Revision	A.02.00

Disabled

Disables the GPIB Controller capability, this is the default (or normal) setting.

Key Path	System, I/O Config, GPIB, GPIB Controller
Example	:SYST:COMM:GPIB:CONT OFF Will set GPIB port to Device
Initial S/W Revision	A.02.00

Enabled

Enables the GPIB Controller capability.

Key Path	System, I/O Config, GPIB, GPIB Controller
Example	:SYST:COMM:GPIB:CONT ON Will set GPIB port to Controller
Initial S/W Revision	A.02.00

SCPI LAN

Activates a menu for identifying and changing the SCPI over a LAN configuration. There are a number of different ways to send SCPI remote commands to the instrument over LAN. It can be a problem to have multiple users simultaneously accessing the instrument over the LAN. These keys limit that

System Functions

System

somewhat by disabling the telnet, socket, and/or SICL capability.

Key Path	System, I/O Config
Initial S/W Revision	Prior to A.02.00

SCPI Telnet

Turns the SCPI LAN telnet capability On or Off allowing you to limit SCPI access over LAN through telnet.

Key Path	System, I/O Config, SCPI LAN
Mode	All
Remote Command	:SYSTem:COMMunicate:LAN:SCPI:TELNet:ENABle OFF ON 0 1 :SYSTem:COMMunicate:LAN:SCPI:TELNet:ENABle?
Example	:SYST:COMM:LAN:SCPI:TELN:ENAB OFF
Preset	This is unaffected by Preset but is set to ON with a “Restore System Defaults->Misc”
State Saved	No
Range	On Off
Initial S/W Revision	Prior to A.02.00

SCPI Socket

Turns the capability of establishing Socket LAN sessions On or Off. This allows you to limit SCPI access over LAN through socket sessions.

Key Path	System, I/O Config, SCPI LAN
Mode	All
Remote Command	:SYSTem:COMMunicate:LAN:SCPI:SOCKet:ENABle OFF ON 0 1 :SYSTem:COMMunicate:LAN:SCPI:SOCKet:ENABle?
Example	:SYST:COMM:LAN:SCPI:SOCK:ENAB OFF
Preset	This is unaffected by a Preset but is set to ON with a “Restore System Defaults->Misc”
State Saved	No
Range	On Off
Initial S/W Revision	Prior to A.02.00

SCPI Socket Control Port (Remote Command Only)

Returns the TCP/IP port number of the control socket associated with the SCPI socket session. This query enables you to obtain the unique port number to open when a device clear is to be sent to the

instrument. Every time a connection is made to the SCPI socket, the instrument creates a peer control socket. The port number for this socket is random. The user must use this command to obtain the port number of the control socket. To force a device clear on this socket, open the port and send the string “DCL ” to the instrument.

If this SCPI command is sent to a non SCPI Socket interface, then 0 is returned.

Mode	All
Remote Command	:SYSTem:COMMunicate:LAN:SCPI:SOCKet:CONTRol?
Example	:SYST:COMM:LAN:SCPI:SOCK:CONT?
Preset	This is unaffected by Preset or “Restore System Defaults->Misc”.
State Saved	No
Range	0 to 65534
Initial S/W Revision	Prior to A.02.00

SICL Server

Turns the SICL server capability On or Off, enabling you to limit SCPI access over LAN through the SICL server. (SICL IEEE 488.2 protocol.)

Parameter	Description	Setting
Maximum Connections	The maximum number of connections that can be accessed simultaneously	5
Instrument Name	The name (same as the remote SICL address) of your analyzer	inst0
Instrument Logical Unit	The unique integer assigned to your analyzer when using SICL LAN	8
Emulated GPIB Name	The name (same as the remote SICL address) of the device used when communicating with your analyzer	gpib7
Emulated GPIB Logical Unit	The unique integer assigned to your device when it is being controlled using SICL LAN	8
Emulated GPIB Address	The emulated GPIB address assigned to your transmitter tester when it is a SICL server (the same as your GPIB address)	18

Key Path	System, I/O Config, SCPI LAN
Mode	All
Remote Command	:SYSTem:COMMunicate:LAN:SCPI:SICL:ENABle OFF ON 0 1 :SYSTem:COMMunicate:LAN:SCPI:SICL:ENABle?
Example	:SYST:COMM:LAN:SCPI:SICL:ENAB OFF

System Functions
System

Preset	This is unaffected by Preset, but is set to ON with a “Restore System Defaults->Misc”
State Saved	No
Range	On Off
Initial S/W Revision	Prior to A.02.00

Reset Web Password

The embedded web server contains certain capability which are password protected; modifying the LAN configuration of the instrument, and access to web pages that can change the settings of the instrument. The default password from the factory is ‘agilent’ (without the quotes). The control provided here is the means to set the web password as the user desires, or to reset the password to the factory default.

Selecting Reset web password brings up a control for resetting the password as the user desires, or to the factory default. A keyboard is required to change the password from the factory default of ‘agilent’ or to set a new password that contains alphabetic characters. The control is:



If this control is entered without an external keyboard or mouse connected, you can cancel the control by pressing the Cancel (ESC) front-panel key.

Key Path	System, I/O Config
Mode	All
Initial S/W Revision	Prior to A.02.00

LXI

Opens a menu that allows you to access the various LXI configuration properties.

Key Path	System, I/O Config
Initial S/W Revision	Prior to A.02.00

LAN Reset

Resets the LAN connection.

Key Path	System, I/O Config, LXI
Initial S/W Revision	Prior to A.02.00

LXI Domain

The instrument only receives LXI LAN Events sent by members of the same LXI Domain. Conversely, LXI Output LAN Events sent by the instrument can only be received by members of the same LXI Domain..

Key Path	System, I/O Config, LXI
Remote Command	:LXI:EVENT:DOMain <intDomain> :LXI:EVENT:DOMain?
Example	:LXI:EVEN:DOM 128 :LXI:EVEN:DOM?
Preset	Not affected by a Preset. The default value of "0" can be restored by pressing Restore Defs, Input/Output Settings
State Saved	Saved in instrument state.
Range	0–255
Initial S/W Revision	Prior to A.02.00

LXI Output LAN Events

The device can be configured to send LXI LAN Events as the instrument's state changes. Specifically, it can notify other devices as the status signals WaitingForTrigger, Sweeping, Measuring, OperationComplete, and Recalling transition. Additionally, Output LAN Events can be sent in response to the receipt of any of the Input LAN Events.

This is the entry point for the LXI Output LAN Event system. This key branches to a list of events that can be sent out on the LAN in response to instrument events.

Key Path	System, I/O Config, LXI
Initial S/W Revision	Prior to A.02.00

Disable All

This command causes the Enable property of all members of the LXI Output LAN Event List to be set to OFF.

Key Path	System, I/O Config, LXI, LXI Output LAN Events
Remote Command	:LXI:EVENT[:OUTPut]:LAN:DISable:ALL
Example	:LXI:EVEN:LAN:DIS:ALL

Initial S/W Revision	Prior to A.02.00
----------------------	------------------

Output LAN Event List

This is the list of LXI Output LAN events that can be sent in response to an instrument event such as sweeping or waiting for a trigger. Each member of this list has a key in the LXI Output LAN Events panel. The list can grow and shrink in response to Add and Remove commands respectively. New pages must be added and removed automatically as the list size changes. Only the first 14 characters of an LXI Output LAN Event name are displayed on the key.

Key Path	System, I/O Config, LXI, LXI Output LAN Events
Remote Command	:LXI:EVENT[:OUTPut] :LAN:LIST?
Example	:LXI:EVEN:LAN:LIST? Returns the complete list of Output LAN Events which is, at minimum: "LAN0", "LAN1", "LAN2", "LAN3", "LAN4", "LAN5", "LAN6", "LAN7", "WaitingForTrigger", "Measuring", "Sweeping", "OperationComplete", "Recalling"
Preset	Not affected by a Preset. The default values can be restored by pressing Restore Defs, Input/Output Settings. Preset/Default values: "LAN0", "LAN1", "LAN2", "LAN3", "LAN4", "LAN5", "LAN6", "LAN7", "WaitingForTrigger", "Measuring", "Sweeping", "OperationComplete", "Recalling"
State Saved	Saved in instrument state.
Readback Text	Displays the value of the LXI Output LAN Event Enabled parameter (Enabled Disabled). Also displays the value of the LXI Output LAN Event Source parameter (WaitingForTrig Sweeping Measuring OpComplete Recalling)
Initial S/W Revision	Prior to A.02.00

Add (Remote Command Only)

Adds the provided string to the list of possible LAN events to output as a response to instrument events. As new LAN events are added, keys are generated in the LXI Output LAN Events menu. New key panels are generated as the number of possible LAN events increases past a multiple of six, and the "More" keys are updated to reflect the new number of key panels in the LXI Output LAN Events menu.

Remote Command	:LXI:EVENT[:OUTPut] :LAN:ADD "LANEVENT"
Example	:LXI:EVEN:LAN:ADD "LANEVENT"
Notes	The maximum length of the string is 16 characters. Longer strings are concatenated and added to the LXI Output LAN Event list. No event is added if the LAN Event already exists.
State Saved	No
Range	Uppercase, Lowercase, Numeric, Symbol except for comma or semicolon
Initial S/W Revision	Prior to A.02.00

Remove (Remote Command Only)

Removes the provided string from the list of possible LAN events to output as a response to instrument events. As new LAN events are removed, keys are removed from the LXI Output LAN Events menu. Key panels are removed as the number of possible LAN events decreases past a multiple of six, and the “More” keys are updated to reflect the new number of key panels in the LXI Output LAN Events menu. Events from the default list cannot be removed.

Remote Command	:LXI:EVENT[:OUTPut]:LAN:REMOve[:EVENT] "LANEVENT"
Example	:LXI:EVEN:LAN:REM "LANEVENT"
Notes	The maximum length of the string is 16 characters. Longer strings are concatenated and the resulting LAN Event is removed from the LXI Output LAN Event list. Nothing happens if the LAN event was not introduced using the Add command.
State Saved	No
Range	Uppercase, Lowercase, Numeric, Symbol
Initial S/W Revision	Prior to A.02.00

Remove All (Remote Command Only)

Clears the list of custom LAN events (those introduced using the Add command) that are available to output as a response to instrument events. As new LAN events are removed, keys are removed from the LXI Output LAN Events menu. Key panels are removed as the number of possible LAN events decreases past a multiple of six, and the “More” keys are updated to reflect the new number of key panels in the LXI Output LAN Events menu.

Remote Command	:LXI:EVENT[:OUTPut]:LAN:REMOve:ALL
Example	:LXI:EVEN:LAN:REM:ALL
Notes	Only LAN Events added with the Add command are removed. Default events cannot be removed.
Initial S/W Revision	Prior to A.02.00

Source

Sets the instrument event that this LXI Output LAN event is tied to.

The possible instrument events are “WaitingForTrigger”, “Sweeping”, “Measuring”, “OperationComplete”, and “Recalling”.

The key is labeled with the value of the selected source.

For the instrument event specific LXI Output LAN Events “WaitingForTrigger,” “Sweeping,” “Measuring,” “OperationComplete,” and “Recalling,” this parameter is set to the corresponding source value and cannot be changed. For these events, the Source key does not appear.

WaitingForTrigger, Measuring, and Sweeping correspond to the standard trigger state machine activities for which they are named.

OperationComplete is low when a measurement operation is underway. For example, OperationComplete is low

System Functions

System

throughout a list sweep measurement, even though Sweeping, Measuring, and WaitingForTrigger will undergo a number of transitions. In this case, OperationComplete goes high when the entire list sweep is finished.

Recalling is high while the instrument is actively recalling a state.

Additionally, the Source parameter can be set to the name of any Input LAN Event. This causes the Output LAN Event to be sent upon receipt of the named Input LAN Event. There is no front panel support for these events.

The default list of available Input LAN Events is:

- “LAN0”
- “LAN1”
- “LAN2”
- “LAN3”
- “LAN4”
- “LAN5”
- “LAN6”
- “LAN7”

Key Path	System, I/O Config, LXI, LXI Output LAN Events, LAN[n]
Remote Command	:LXI:EVENT[:OUTPut]:LAN[:SET]:SOURce "LANEVENT", "SourceEvent" :LXI:EVENT[:OUTPut]:LAN[:SET]:SOURce? "LANEVENT"
Example	:LXI:EVEN:LAN:SOUR "LANEVENT","WaitingForTrigger"
Notes	The maximum length of the string is 45 characters.
Preset	Not affected by a Preset. The default values can be restored by pressing Restore Defs, Input/Output Settings. Preset/Default values: “Sweeping” (The Output LAN Events “WaitingForTrigger”, “Sweeping”, “Measuring”, “OperationComplete”, and “Recalling” all have default source parameters that match their names)
State Saved	Saved in instrument state.
Range	“WaitingForTrigger” “Sweeping” “Measuring” “OperationComplete” “Recalling” “LAN0” “LAN1” “LAN2” “LAN3” “LAN4” “LAN5” “LAN6” “LAN7” any user-added Input LAN Event
Initial S/W Revision	Prior to A.02.00

Destination (Remote Command Only)

Outgoing LAN events are sent to the hosts enumerated in the destination expression. This expression takes the form of “host1:port1, host2:port2, ...” where port numbers are optional, and default to the IANA assigned TCP port (5044). To designate a UDP broadcast at the default port, set the destination string to “*” or “ALL”. To designate a UDP broadcast at a specific port, set the destination string to “:port” or “ALL:port”.

Examples:

- “192.168.0.1:23”
- “agilent.com, soco.agilent.com”
- “agilent.com:80, 192.168.0.1”

Remote Command	:LXI:EVENT[:OUTPut]:LAN[:SET]:DESTination "LANEVENT", "destinationExpression" :LXI:EVENT[:OUTPut]:LAN[:SET]:DESTination? "LANEVENT"
Example	:LXI:EVEN:LAN:DEST "LANEVENT", "host1, 192.168.0.1:80"
Notes	The maximum length of the string is 45 characters.
Preset	Not affected by a Preset. The default value of "ALL" can be restored by using the command: :SYSTem:DEFault INPut
State Saved	Saved in instrument state.
Range	Uppercase, Lowercase, Numeric, Symbol
Initial S/W Revision	Prior to A.02.00

Drive

Determines the behavior of an output event.

- Normal designates typical operation, where both edges of the instrument event are transmitted,
- Off disables the LAN event.
- Wired-OR causes only one edge to be transmitted.

Key Path	System, I/O Config, LXI, LXI Output LAN Events, LAN[n]
Remote Command	:LXI:EVENT[:OUTPut]:LAN[:SET]:DRIVE "LANEVENT", OFF NORMal WOR :LXI:EVENT[:OUTPut]:LAN[:SET]:DRIVE? "LANEVENT"
Example	:LXI:EVEN:LAN:DRIV "LANEVENT",WOR
Preset	Not affected by a Preset. The default value of "NORMal" can be restored by using the command: :SYSTem:DEFault INPut
State Saved	Saved in instrument state.
Range	OFF NORMal WOR
Initial S/W Revision	Prior to A.02.00

Slope

Determines which instrument event transition results in a LAN packet being sent and whether or not that edge is inverted.

When the Drive parameter is set to Normal, a Slope of Negative causes both edges to be inverted before they are transmitted. A Positive Slope transmits the edges unaltered.

When the Drive parameter is set to WOR, only Positive edges are transmitted. When the Slope is Negative, a falling edge is inverted and sent as a rising edge. When the Slope is Positive, a rising edge is sent normally.

The following table illustrates the effects of the Slope and Drive parameters.

Instrument Event Edge	Slope Parameter	Drive Parameter	Action
0	Negative	Off	Not sent
0	Positive	Off	Not sent
1	Negative	Off	Not sent
1	Positive	Off	Not sent
0	Negative	Normal	1
0	Positive	Normal	0
1	Negative	Normal	0
1	Positive	Normal	1
0	Negative	Wired OR	1
0	Positive	Wired OR	Not sent
1	Negative	Wired OR	Not sent
1	Positive	Wired OR	0

Key Path	System, I/O Config, LXI, LXI Output LAN Events, LAN[n]
Remote Command	:LXI:EVENT[:OUTPUT]:LAN[:SET]:SLOPe "LANEVENT", POSitive NEGative :LXI:EVENT[:OUTPUT]:LAN[:SET]:SLOPe? "LANEVENT"
Example	:LXI:EVEN:LAN:SLOP "LANEVENT",POS
Preset	Not affected by a Preset. The default value of "Positive" can be restored by using the command: :SYSTem:DEFault INPut
State Saved	Saved in instrument state.
Range	POSitive NEGative
Initial S/W Revision	Prior to A.02.00

Timestamp Delta

This parameter represents a time in seconds to add to the timestamp of the Output LAN Event. This timestamp delta allows the receiving instrument to delay its response until the time specified in the timestamp.

Key Path	System, I/O Config, LXI, LXI Output LAN Events, LAN[n]
Remote Command	:LXI:EVENT[:OUTPut]:LAN[:SET]:TSDelta "LANEVENT", <seconds> :LXI:EVENT[:OUTPut]:LAN[:SET]:TSDelta? "LANEVENT"
Example	:LXI:EVEN:LAN:TSD "LANEVENT",10.5 s
Preset	Not affected by a Preset. The default value of "0.0 s" can be restored by using the command: :SYSTem:DEFault INPut
State Saved	Saved in instrument state.
Range	0.0 – 1.7976931348623157 x 10308 s(Max Double)
Initial S/W Revision	Prior to A.02.00

Enabled

If this parameter is set to ON, this LAN Event is sent when the selected Source instrument event occurs.

Otherwise, this LAN Event is never output.

Key Path	System, I/O Config, LXI, LXI Output LAN Events, LAN[n]
Remote Command	:LXI:EVENT[:OUTPut]:LAN[:SET]:ENABled "LANEVENT",ON OFF 1 0 :LXI:EVENT[:OUTPut]:LAN[:SET]:ENABled? "LANEVENT"
Example	:LXI:EVEN:LAN:ENAB "LAN0",ON
Preset	Not affected by a Preset. The default value of "OFF" can be restored by using the command: :SYSTem:DEFault INPut
State Saved	Saved in instrument state.
Range	OFF ON 0 1
Initial S/W Revision	Prior to A.02.00

Count (Remote Command Only)

Returns the number of items in the LXI Output LAN Event List.

Remote Command	:LXI:EVENT[:OUTPut]:LAN:COUNT?
Example	:LXI:EVEN:LAN:COUN?
Initial S/W Revision	Prior to A.02.00

Configure (Remote Command Only)

Allows the configuration of some parameters from a single SCPI command.

Remote Command	:LXI:EVENT[:OUTPut]:LAN[:SET]:CONFigure "lanEvent", <enabled>, <source>, <slope>, <drive>, <destination>
Example	:LXI:EVEN:LAN:CONF "LAN0",1,"WaitingForTrigger",POS,NORM,"ALL"
Initial S/W Revision	Prior to A.02.00

Send (Remote Command Only)

Forces the instrument to send the requested LAN Event. The LAN Event must be enabled, otherwise this command is ignored.

Remote Command	:LXI:EVENT[:OUTPut]:LAN:SEND "LANEVENT", RISE FALL
Example	:LXI:EVEN:LAN:SEND "LANEVENT", FALL
Initial S/W Revision	Prior to A.02.00

Identifier (Remote Command Only)

Sets the string that will be placed in the peer-to-peer packet when the Output LAN Event is transmitted. The Identifier is variable to allow for easier system debugging. The Identifier must be unique, for example the "LAN0" and "LAN1" output events cannot have identical identifiers.

Remote Command	:LXI:EVENT[:OUTPut]:LAN[:SET]:IDENTifier "LANEVENT", "identifier" :LXI:EVENT[:OUTPut]:LAN[:SET]:IDENTifier? "LANEVENT"
Example	:LXI:EVEN:LAN:IDEN"LAN0","debugstring"
Notes	The maximum length of the string is 16 characters. Nothing happens if the LAN event does not exist. The default value is that the identifier is equivalent to the name of the LAN Event.
State Saved	Saved in instrument state.
Range	Uppercase, Lowercase, Numeric, Symbol
Initial S/W Revision	Prior to A.02.00

System IDN Response

This key allows you to specify a response to the *IDN? query, or to return the analyzer to the Factory response if you have changed it.

To choose the factory-set response, press the **Factory** key.

To specify your own response, press the **User** key, and enter your desired response.

Key Path	System, I/O Config
Mode	All
Remote Command	:SYSTem:IDN <string> :SYSTem:IDN?
Notes	<ul style="list-style-type: none"> This affects the response given in all Modes of the Analyzer, unless the current Mode has also specified a custom response, in which case the current Mode's custom IDN response takes precedence over the System's, but only while that Mode is the current Mode.. It survives shutdown and restart of the software and therefore survives a power cycle Null string as parameter restores the Factory setting
Preset	This is unaffected by Preset but is set to the original factory setting on a "Restore System Defaults->Misc"
State Saved	No
Initial S/W Revision	A.06.00

Factory

This key selects the factory setting, for example:

"Agilent Technologies,N9020A,MY00012345,A.05.01"

where the fields are manufacturer, model number, serial number, firmware revision.

Key Path	System, I/O Config, IDN Response
Example	:SYST:IDN "" null string, restores the factory setting
Initial S/W Revision	A.06.0

User

This key allows you to specify your own response to the *IDN? query. You may enter your desired response with the Alpha Editor or a plugin PC keyboard.

When you press this key, the active function becomes the current User string with the cursor at the end. This makes it easy to edit the existing string.

If you enter a null string (for example, by clearing the User String while editing and then pressing **Done**) the analyzer automatically reverts to the Factory setting.

Key Path	System, I/O Config, IDN Response
Example	:SYST:IDN "XYZ Corp,Model 12,012345,A.01.01" user specified response
Initial S/W Revision	A.06.00

Query USB Connection (Remote Command Only)

Enables you to determine the speed of the USB connection.

Mode	All
Remote Command	:SYSTem:COMMunicate:USB:CONNectioN?
Example	:SYST:COMM:USB:CONN?
Notes	<p>NONE – Indicates no USB connection has been made.</p> <p>LSPeed – Indicates a USB low speed connection (1.5 Mbps).</p> <p>This is reserved for future use, the T+M488 protocol is not supported on low speed connections.</p> <p>HSPeed – Indicates that a USB high speed connection (480 Mbps) has been negotiated.</p> <p>FSPeed – Indicates that a USB full speed connection (12 Mbps) has been negotiated.</p>
State Saved	No
Range	NONE LSPeed HSPeed FSPeed
Initial S/W Revision	Prior to A.02.00

USB Connection Status (Remote Command Only)

Enables you to determine the current status of the USB connection.

Mode	All
Remote Command	:SYSTem:COMMunicate:USB:STATus?
Example	:SYST:COMM:USB:STAT?
Notes	<p>SUSPended – Indicates that the USB bus is currently in its suspended state. The bus is in the suspended state when:</p> <ul style="list-style-type: none"> The bus is not connected to any controller The controller is currently powered off The controller has explicitly placed the USB device into the suspended state. <p>When in the suspended state, no USB activity, including start of frame packets are received.</p> <p>ACTive – Indicates that the USB device is in the active state. When the device is in the active state, it is receiving periodic start of frames but it isn't necessarily receiving or transmitting data.</p>
State Saved	No
Range	SUSPended ACTive
Initial S/W Revision	Prior to A.02.00

USB Packet Count (Remote Command Only)

Enables you to determine the number of packets received and transmitted on the USB bus.

Mode	All
Remote Command	:SYSTem:COMMunicate:USB:PACKets?
Example	:SYST:COMM:USB:PACK?
Notes	<p>Two integers are returned. The first is the number of packets received since application invocation, the second is the number of packets transmitted since application invocation. If no packets have been received or transmitted the response is 0,0.</p> <p>The packet count is initialized to 0,0 when the instrument application is started.</p>
State Saved	No
Initial S/W Revision	Prior to A.02.00

User Preset

Accesses a menu that gives you the following three choices:

User Preset – recalls a state previously saved using the **Save User Preset** function.

User Preset All Modes – presets all of the modes in the analyzer

Save User Preset – saves the current state for the current mode

Key Path	Front-panel key
Backwards Compatibility Notes	<p>User Preset is actually loading a state, and in legacy analyzers, it was possible to load a state without affecting the trace data, limit lines or correction data. Similarly it was possible to do a User Preset without affecting the trace data, limit lines or correction data.</p> <p>In the X-Series, “state” always includes all of this data; so whenever state is loaded, or User Preset is executed, all of the traces, limit lines and corrections are affected. Although this differs from previous behavior, it is desirable behavior, and should not cause adverse issues for users.</p> <p>On ESA and PSA, User Preset affected the entire instrument’s state. In the X-Series, User Preset only recalls the state for the active mode. There is a User Preset file for each mode. User Preset can never cause a mode switch as it can in legacy analyzers. If you want to recall all modes to their user preset file state, you will need to do a User Preset after mode switching into each mode.</p> <p>User Preset recalls mode state which can now include data like traces; whereas on ESA and PSA, User Preset did not affect data.</p>
Initial S/W Revision	Prior to A.02.00

User Preset

User Preset sets the state of the currently active mode back to the state that was previously saved for this mode using the **Save User Preset** menu key or the SCPI command, SYST:PRES:USER:SAV. It not only recalls the Mode Preset settings, but it also recalls all of the mode persistent settings, and the Input/Output system setting that existed at the time **Save User Preset** was executed.

If a **Save User Preset** has not been done at any time, **User Preset** recalls the default user preset file for the currently active mode. The default user preset files are created if, at power-on, a mode detects there is no user preset file. There will never be a scenario when there is no user preset file to restore. For each mode, the default user preset state is the same state that would be saved if a **Save User Preset** is performed in each mode right after doing a Restore Mode Default and after a Restore Input/Output Defaults.

The User Preset function does the following:

- Aborts the currently running measurement.
- Sets the mode State to the values defined by **Save User Preset**.

- Makes the saved measurement for the currently running mode the active measurement.
- Brings up the saved menu for the power-on mode.
- Clears the input and output buffers.
- Sets the Status Byte to 0.

Key Path	User Preset
Remote Command	:SYSTem:PRESet:USER
Example	:SYST:PRES:USER:SAVE :SYST:PRES:USER
Notes	:SYST:PRES:USER:SAVE is used to save the current state as the user preset state. Clears all pending OPC bits. The Status Byte is set to 0. Pressing the User Preset front-panel key while already in the User Preset menu will cause the User Preset to get executed
Couplings	A user preset will cause the currently running measurement to be aborted and cause the saved measurement to be active. Recalling a User Preset file has the same issues that recalling a Save State file has. Some settings may need to be limited and therefore re-coupled, since the capabilities of the mode may have changes when the User Preset file was last saved.
Initial S/W Revision	Prior to A.02.00

User Preset All Modes

Recalls all of the User Preset files for each mode, switches to the power-on mode, and activates the saved measurement from the power-on mode User Preset file.

NOTE When the instrument is secured, all of the user preset files are converted back to their default user preset files.

The User Preset function does the following:

- Aborts the currently running measurement.
- Switches the Mode to the power-on mode.
- Restores the User Preset files for each mode.
- Makes the saved measurement for the power-on mode the active measurement.
- Brings up the saved menu for the power-on mode.
- Clears the input and output buffers.
- Sets the Status Byte to 0.

System Functions
User Preset

Key Path	User Preset
Remote Command	:SYSTem:PRESet:USER:ALL
Example	:SYST:PRES:USER:SAVE :SYST:PRES:USER:ALL
Notes	Clears all pending OPC bits. The Status Byte is set to 0. :SYST:PRES:USER:SAVE is used to save the current state as the user preset state.
Couplings	A user preset will cause the currently running measurement to be aborted, cause a mode switch to the power-on mode, and cause the saved measurement to be active in the power-on mode. Recalling a User Preset file has the same issues that recalling a Save State file has. Some settings may need to be limited and therefore re-coupled, since the capabilities of the mode may have changes when the User Preset file was last saved.
Initial S/W Revision	Prior to A.02.00

Save User Preset

Saves the currently active mode and its State. You can recall this User Preset file by pressing the User Preset menu key or sending the SYST:PRES:USER remote command. This same state is also saved by the Save State function.

Key Path	User Preset
Remote Command	:SYSTem:PRESet:USER:SAVE
Example	:SYST:PRES:USER:SAVE
Notes	:SYST:PRES:SAVE creates the same file as if the user requested a *SAV or a MMEM:STOR:STAT, except User Preset Save does not allow the user to specify the filename or the location of the file.
Initial S/W Revision	Prior to A.02.00

The Channel Power measurement is used to find the total power present in a specified bandwidth. The power spectral density (the power in the signal normalized to 1 Hz) is also reported (In WLAN mode or WLAN radio standard in SA mode, the peak power spectral density for 1 MHz is reported). For measurement results and views, see [“View/Display” on page 380](#).

For information on how to make measurement using the X-Series Signal Analyzer, see: Measurement Guide [n9080-90006.pdf].

This topic contains the following sections:

[“Measurement Commands for Channel Power” on page 315](#)

[“Remote CommandResults for Channel Power Measurement” on page 315](#)

Measurement Commands for Channel Power

These commands are used to measure the total rms power in a specified integration bandwidth.

Use :INSTRument:SELect to set the mode.

```
:CONFigure:CHPower
:CONFigure:CHPower:NDEFault
:INITiate:CHPower
:FETCh:CHPower[n]?
:MEASure:CHPower[n]?
:READ:CHPower[n]?
:FETCh:CHPower:CHPower?
:MEASure:CHPower:CHPower?
:READ:CHPower:CHPower?
:FETCh:CHPower:DENSity?
:MEASure:CHPower:DENSity?
:READ:CHPower:DENSity
```

For more measurement related commands, see the SENSE subsystem, and the section [“Remote Measurement Functions” on page 1520](#).

Remote CommandResults for Channel Power Measurement

For DVB-T/H and DTMB (CTTB) mode, see [“DVB-T/H and DTMB \(CTTB\) Mode Remote Command Results” on page 316](#).

For ISDB-T and CMMB mode, see [“ISDB-T and CMMB mode Remote Command Results” on page 318](#).

For MSR, see “MSR Mode Remote Command Results” on page 319 Mode Remote Command Results

Command	Return Value
FETCh:CHPower[n]? MEASure:CHPower[n]? READ:CHPower[n]?	Refer to the table below.
FETCh:CHPower:CHPower? MEASure:CHPower:CHPower? READ:CHPower:CHPower?	Returns the Channel Power (dBm) (BW compatibility functionality)
FETCh:CHPower:DENSity? MEASure:CHPower:DENSity? READ:CHPower:DENSity?	Returns the Power Spectral Density (dBm/Hz) (BW compatibility functionality)

n	Results Returned
n=1 (or not specified)	Returns scalar results: <ol style="list-style-type: none"> 1. Channel Power is a floating point number representing the total channel power in the specified integration bandwidth. 2. PSD (Power Spectral Density) is the power in the specified unit bandwidth. The unit bandwidth is selected by the PSD Unit parameter in either dBm/Hz or dBm/MHz.
2	Returns floating point numbers that are the captured trace data of the power (in dBm/resolution BW) of the signal. The frequency span of the captured trace data is specified by the Span key.

DVB-T/H and DTMB (CTTB) Mode Remote Command Results

The following commands are available only for DVB-T/H and DTMB (CTTB) mode.

Condition	n	Results Returned
	n=1 (or not specified)	Returns scalar results: <ol style="list-style-type: none"> 1. Channel Power is a floating point number representing the total channel power in the specified integration bandwidth. 2. PSD (Power Spectral Density) is the power in the specified unit bandwidth. The unit bandwidth is selected by the PSD Unit parameter in either dBm/Hz or dBm/MHz.
	2	Returns floating point numbers that are the captured trace data of the power (in dBm/resolution BW) of the signal. The frequency span of the captured trace data is specified by the Span key.

Condition	n	Results Returned
Mode = DVB-T/H or Mode = DTMB (CTTB)	3	Returns 7 comma-separated scalar results, in the following order. <ol style="list-style-type: none"> 1. The shoulder attenuation result (dB) 2. Lower shoulder attenuation result (dB) 3. Upper shoulder attenuation result (dB) 4. Lower Offset - MAX shoulder point power (dBm) 5. Lower Offset - MAX shoulder point frequency (MHz) 6. Upper Offset - MAX shoulder point power (dBm) 7. Upper Offset - MAX shoulder point frequency (MHz) If the results are not available, -999.0 is returned. For example, if current view is RF spectrum or spectrum mask, -999.0 is returned.
Mode = DVB-T/H or Mode = DTMB (CTTB)	4	Returns floating point numbers that are the captured trace data of the power (in dBm/resolution BW) of the signal in the left graph of the shoulder attenuation view. If the results are not available, -999.0 is returned. For example, if current view is RF spectrum or spectrum mask, -999.0 is returned.
Mode = DVB-T/H or Mode = DTMB (CTTB)	5	Returns floating point numbers that are the captured trace data of the power (in dBm/resolution BW) of the signal in the right graph of the shoulder attenuation view. If the results are not available, -999.0 is returned. For example, if current view is RF spectrum or spectrum mask, -999.0 is returned.
Mode = DVB-T/H or Mode = DTMB (CTTB)	6	Returns floating point numbers that are the captured trace data of the power (in dBm/resolution BW) of the mask in the spectrum mask view. If the results are not available, -999.0 is returned. For example, if current view is RF spectrum or shoulder attenuation, -999.0 is returned.

Condition	n	Results Returned
Mode = DVB-T/H or Mode = DTMB (CTTB)	7	<p>Returns the failed point information in the following order:</p> <ol style="list-style-type: none"> 1. the 1st failed point frequency (MHz) 2. the 1st failed point absolute power (dBm) 3. the 1st failed point relative power (dB) 4. the 2nd failed point frequency (MHz) 5. the 2nd failed point absolute power (dBm) 6. the 2nd failed point relative power (dB) ... 3*N-2. the (3*N-2)th failed point frequency (MHz) 3*N-1. the (3*N-1)th failed point absolute power (dBm) 3*N. the (3*N)th failed point relative power (dB) <p>If the number of failed points is less than 20, it will show all of them (frequency, power and relative power), N<20;</p> <p>If the number of failed points is great than 20, the first ten failed points and the last ten failed points will be show, N=20.</p> <p>If the results are not available, -999.0 is returned.</p> <p>For example, if current view is RF spectrum or shoulder attenuation, -999.0 is returned.</p>

ISDB-T and CMMB mode Remote Command Results

The following commands are available only for ISDB-T and CMMB mode.

Condition	n	Results Returned
	n=1 (or not specified)	<p>Returns scalar results:</p> <ol style="list-style-type: none"> 1. Channel Power is a floating point number representing the total channel power in the specified integration bandwidth. 2. PSD (Power Spectral Density) is the power in the specified unit bandwidth. The unit bandwidth is selected by the PSD Unit parameter in either dBm/Hz or dBm/MHz.
	2	<p>Returns floating point numbers that are the captured trace data of the power (in dBm/resolution BW) of the signal. The frequency span of the captured trace data is specified by the Span key.</p>

Condition	n	Results Returned
Mode = ISDB-T or Mode = CMMB	3	Returns 7 comma-separated scalar results, in the following order. <ol style="list-style-type: none"> 1. The shoulder attenuation result (dB) 2. Lower shoulder attenuation result (dB) 3. Upper shoulder attenuation result (dB) 4. Lower Offset - MAX shoulder point power (dBm) 5. Lower Offset - MAX shoulder point frequency (MHz) 6. Upper Offset - MAX shoulder point power (dBm) 7. Upper Offset - MAX shoulder point frequency (MHz) If the results are not available, -999.0 is returned. For example, if current view is RF spectrum or spectrum mask, -999.0 is returned.
Mode = ISDB-T or Mode = CMMB	4	Returns floating point numbers that are the captured trace data of the power (in dBm/resolution BW) of the signal in the left window of the shoulder attenuation view. If the results are not available, -999.0 is returned. For example, if current view is RF spectrum or spectrum mask, -999.0 is returned.
Mode = ISDB-T or Mode = CMMB	5	Returns floating point numbers that are the captured trace data of the power (in dBm/resolution BW) of the signal in the right window of the shoulder attenuation view. If the results are not available, -999.0 is returned. For example, if current view is RF spectrum or spectrum mask, -999.0 is returned.

MSR Mode Remote Command Results

The following commands are available only for MSR mode.

Condition	n	Results Returned
	n=1 (or not specified)	Returns scalar results: <ol style="list-style-type: none"> 1. Channel Power is a floating point number representing the total channel power in the specified integration bandwidth. 2. PSD (Power Spectral Density) is the power in the specified unit bandwidth. The unit bandwidth is selected by the PSD Unit parameter in either dBm/Hz or dBm/MHz.
	2	Returns floating point numbers that are the captured trace data of the power (in dBm/resolution BW) of the signal. The frequency span of the captured trace data is specified by the Span key.

Channel Power Measurement

Condition	n	Results Returned
Mode = MSR	3	Returns [Carriers] comma-separated scalar results, in the following order. 1. Total Power of Carrier 1 (dBm) 2. Total Power of Carrier 2 (dBm) ... [Carriers]. Total Power of Carrier [Carriers] (dBm) If the result is not available, NaN (9.91E+37) is returned. Number of returned values might be changed in future releases.
Mode = MSR	4	Returns 3 comma-separated scalar results, in the following order. 1. Total Power of LTE FDD carriers (dBm) 2. Total Power of W-CDMA carriers (dBm) 3. Total Power of GSM/EDGE carriers (dBm) If the result is not available, NaN (9.91E+37) is returned. Number of returned values will be changed in future releases if the number of supported radio format is increased.

Key Path	Meas
Mode	SA, WCDMA, C2K, WIMAX OFDMA, 1xEVDO, DVB-T/H, DTMB (CTTB), ISDB-T, CMMB, LTE, LTETDD, Digital Cable TV, WLAN, MSR
Initial S/W Revision	Prior to A.02.00
Modified at S/W Revision	A.03.00

AMPTD Y Scale

Accesses a menu of functions that enable you to set the vertical scale parameters. The parameter values are measurement independent, except all Attenuation values and the Internal Preamp selection, which are the same across all measurements.

Key Path	Front-panel key
Initial S/W Revision	Prior to A.02.00

Ref Value

Sets the value for the absolute power reference. However, since the Auto Scaling is defaulted to On, this value is automatically determined by the measurement result. When you set a value manually, Auto Scaling automatically changes to Off.

Key Path	AMPTD Y Scale
Mode	SA, WCDMA, C2K, WIMAX OFDMA, 1xEVDO, DVB-T/H, DTMB (CTTB), ISDB-T, CMMB, LTE, LTETDD, Digital Cable TV, WLAN, MSR
Remote Command	:DISPlay:CHPower:VIEW[1]:WINDow[1]:TRACe:Y[:SCALE]:RLEV el <real> :DISPlay:CHPower:VIEW[1]:WINDow[1]:TRACe:Y[:SCALE]:RLEV el?
Example	DISP:CHP:VIEW:WIND:TRAC:Y:RLEV 10 dBm DISP:CHP:VIEW:WIND:TRAC:Y:RLEV?
Notes	You must be in the Spectrum Analysis mode, W-CDMA mode, cdma2000 mode, DVB-T/H mode, DTMB (CTTB) mode, ISDB-T mode, CMMB mode, Digital Cable TV mode, LTD mode, LTE TDD mode, WLAN mode, 1xEVDO mode, MSR or WIMAX OFDMA mode to use this command. Use :INSTrument:SElect to set the mode.
Couplings	When the Auto Scaling is On, this value is automatically determined by the measurement result. When you set a value manually, Auto Scaling automatically changes to Off.
Preset	10.00 dBm
State Saved	Saved in instrument state.
Min	-250.00 dBm
Max	250.00 dBm
Initial S/W Revision	Prior to A.02.00
Modified at S/W Revision	A.02.00, A.03.00

Attenuation

Accesses a menu of functions that enable you to change the attenuation settings. This key has read-back text that describes the total attenuator value.

See AMPTD Y Scale, “Attenuation” on page 1381 for more information.

Key Path	AMPTD/Y Scale
Initial S/W Revision	Prior to A.02.00

Range

Accesses the Range menu to change baseband I/Q gain settings. This key has a readback text that describes gain range value.

Key Path	AMPTD/Y Scale
Initial S/W Revision	Prior to A.02.00

Scale/Div

Sets the units per division of the vertical scale in the logarithmic display. However, since the Auto Scaling is defaulted to On, this value is automatically determined by the measurement result. When you set a value manually, Auto Scaling automatically changes to Off.

Key Path	AMPTD Y Scale
Mode	SA, WCDMA, C2K, WIMAX OFDMA, 1xEVDO, DVB-T/H, DTMB (CTTB), ISDB-T, CMMB, LTE, LTETDD, Digital Cable TV, WLAN, MSR
Remote Command	:DISPlay:CHPower:VIEW[1]:WINDow[1]:TRACe:Y[:SCALE]:PDIVision <rel_ampl> :DISPlay:CHPower:VIEW[1]:WINDow[1]:TRACe:Y[:SCALE]:PDIVision?
Example	DISP:CHP:VIEW:WIND:TRAC:Y:PDIV 2 DISP:CHP:VIEW:WIND:TRAC:Y:PDIV?
Notes	You must be in the Spectrum Analysis mode, W-CDMA mode, cdma2000 mode, DVB-T/H mode, DTMB (CTTB) mode, ISDB-T mode, CMMB mode, Digital Cable TV mode, LTE mode, LTE TDD mode, WLAN mode, 1xEVDO mode, MSR or WIMAX OFDMA mode to use this command. Use :INSTrument:SElect to set the mode.
Couplings	When the Auto Scaling is On, this value is automatically determined by the measurement result. When you set a value manually, Auto Scaling automatically changes to Off.
Preset	10.00 dB
State Saved	Saved in instrument state.

Min	0.10 dB
Max	20.00 dB
Initial S/W Revision	Prior to A.02.00
Modified at S/W Revision	A.02.00, A.03.00

Presel Center

When this key is pressed, the centering of the preselector filter is adjusted to optimize the amplitude accuracy at the frequency of the selected marker.

See [“Presel Center” on page 1396](#) under AMPTD Y Scale for more information.

This is only available when the selected input is RF.

Key Path	AMPTD/Y Scale
Initial S/W Revision	Prior to A.02.00

Presel Adjust

Allows you to manually adjust the preselector filter frequency to optimize its response to the signal of interest. This function is only available when Presel Center is available.

See [“Preselector Adjust” on page 1398](#) under AMPTD Y Scale for more information.

This is only available when the selected input is RF.

Key Path	AMPTD/Y Scale
Initial S/W Revision	Prior to A.02.00

Y Axis Unit

Allows you to change the vertical (Y) axis amplitude unit.

See [“Y Axis Unit” on page 1399](#) under AMPTD Y Scale for more information.

Key Path	AMPTD/Y Scale
Initial S/W Revision	A.04.00

Reference Level Offset

Adds an offset value to the displayed reference level. The reference level is the absolute amplitude represented by the top graticule line on the display.

See [“Reference Level Offset” on page 1404](#) under AMPTD Y Scale for more information.

Key Path	AMPTD/Y Scale
----------	----------------------

Initial S/W Revision	A.04.00
----------------------	---------

μW Path Control

The **μW Path Control** functions include the **μW Preselector Bypass** (Option MPB) and **Low Noise Path** (Option LNP) controls in the High Band path circuits.

See [μ“W Path Control” on page 1405](#) under AMPTD Y Scale for more information.

Key Path	AMPTD/Y Scale
Initial S/W Revision	A.04.00

Internal Preamp

Accesses a menu of functions that enable you to control the internal preamplifiers.

See AMPTD Y Scale, [“Internal Preamp” on page 1410](#) for more information.

Key Path	AMPTD/Y Scale
Initial S/W Revision	Prior to A.02.00

Ref Position

Positions the reference level at the top, center, or bottom of the Y Scale display. Changing the reference position does not change the reference level value.

Key Path	AMPTD Y Scale
Mode	SA, WCDMA, C2K, WIMAX OFDMA, 1xEVDO, DVB-T/H, DTMB (CTTB), ISDB-T, CMMB, LTE, LTETDD, Digital Cable TV, WLAN, MSR
Remote Command	:DISPlay:CHPower:VIEW[1]:WINDow[1]:TRACe:Y[:SCALE]:RPOS ition TOP CENTer BOTTom :DISPlay:CHPower:VIEW[1]:WINDow[1]:TRACe:Y[:SCALE]:RPOS ition?
Example	DISP:CHP:VIEW:WIND:TRAC:Y:RPOS CENT DISP:CHP:VIEW:WIND:TRAC:Y:RPOS?
Notes	You must be in the Spectrum Analysis mode, W-CDMA mode, cdma2000 mode, DVB-T/H mode, DTMB (CTTB) mode, ISDB-T mode, CMMB mode, Digital Cable TV mode, LTE mode, LTE TDD mode, WLAN mode, 1xEVDO mode, MSR or WIMAX OFDMA mode to use this command. Use :INSTrument:SElect to set the mode.
Preset	TOP
State Saved	Saved in instrument state.
Range	Top Ctr Bot

Initial S/W Revision	Prior to A.02.00
Modified at S/W Revision	A.02.00, A.03.00

Auto Scaling

Toggles the Auto Scaling function between On and Off.

Key Path	AMPTD Y Scale
Mode	SA, WCDMA, C2K, WIMAX OFDMA, 1xEVDO, DVB-T/H, DTMB (CTTB), ISDB-T, CMMB, LTE, LTETDD, Digital Cable TV, WLAN, MSR
Remote Command	:DISPlay:CHPower:VIEW[1]:WINDow[1]:TRACe:Y[:SCALe]:COUPle 0 1 OFF ON :DISPlay:CHPower:VIEW[1]:WINDow[1]:TRACe:Y[:SCALe]:COUPle?
Example	DISP:CHP:VIEW:WIND:TRAC:Y:COUP OFF DISP:CHP:VIEW:WIND:TRAC:Y:COUP?
Couplings	When Auto Scaling is On, and the Restart front-panel key is pressed, this function automatically sets the scale per division to 10 dB and determines the reference values based on the measurement results. When you set a value to either Scale/Div or Ref Value manually, Auto Scaling automatically changes to Off.
Preset	1
State Saved	Saved in instrument state.
Range	On Off
Initial S/W Revision	Prior to A.02.00
Modified at S/W Revision	A.02.00, A.03.00

Auto Couple

See “[Auto Couple](#)” on page 1412 for more information.

Key Path	Front-panel key
----------	-----------------

BW

Accesses a menu of functions that enable you to specify and control the video and resolution bandwidths. You can also select the type of filter for the measurement and set the filter bandwidth.

Key Path	Front-panel key
Initial S/W Revision	Prior to A.02.00

Res BW

Sets the value of the resolution bandwidth (RBW). If an unavailable bandwidth is entered with the numeric keypad, the closest available bandwidth is selected.

Key Path	BW
Mode	SA, WCDMA, C2K, WIMAX OFDMA, 1xEVDO, DVB-T/H, DTMB (CTTB), ISDB-T, CMMB, LTE, LTETDD, Digital Cable TV, WLAN, MSR
Remote Command	[:SENSE]:CHPower:BANDwidth[:RESolution] <bandwidth> [:SENSE]:CHPower:BANDwidth[:RESolution]? [:SENSE]:CHPower:BANDwidth[:RESolution]:AUTO ON OFF 1 0 [:SENSE]:CHPower:BANDwidth[:RESolution]:AUTO?
Example	CHP:BAND 5 MHz CHP:BAND? CHP:BAND:AUTO ON CHP:BAND:AUTO?
Notes	You must be in the Spectrum Analysis mode, W-CDMA mode, cdma2000 mode, DVB-T/H mode, DTMB (CTTB) mode, ISDB-T mode, CMMB mode, Digital Cable TV mode, LTE mode, LTE TDD mode, WLAN mode, 1xEVDO mode, MSR or WIMAX OFDMA mode to use this command. Use :INSTrument:SElect to set the mode.
Couplings	Sweep time is coupled to the RBW. As the RBW changes, the sweep time (if set to Auto) is changed to maintain amplitude calibration. Video bandwidth (VBW) is coupled to the RBW. As the resolution bandwidth changes, the video bandwidth (if set to Auto) changes to maintain the ratio of VBW/RBW (10:1). When the Res BW is set to Auto, the resolution bandwidth is auto-coupled to the span. The ratio of Span/RBW is approximately 106:1 when auto coupled. When Res BW is set to Man, and the bandwidths are entered manually, these bandwidths are used regardless of other analyzer settings.

Channel Power Measurement
BW

Preset	SA: Auto WCDMA: 240 kHz C2K: 24 kHz WIMAX OFDMA: 100kHz 1xEVDO: 30kHz DVB-T/H: 3.9kHz DTMB (CTTB): 3.9kHz ISDB-T: 30kHz CMMB: 3.9kHz LTE: Auto LTETDD: Auto Digital Cable TV: 3.9kHz WLAN: 100 kHz MSR: 100 kHz WCDMA, C2K, 1xEVDO , WIMAX OFDMA, DVB-T/H, DTMB (CTTB), ISDB-T, CMMB, Digital Cable TV, WLAN, MSR: OFF SA, LTE, LTETDD: ON
State Saved	Saved in instrument state.
Min	1 Hz
Max	8 MHz
Backwards Compatibility SCPI	[:SENSe]:CHPower:BWIDth[:RESolution]
Initial S/W Revision	Prior to A.02.00
Modified at S/W Revision	A.02.00, A.03.00

Video BW

Changes the analyzer post-detection filter (VBW).

Key Path	BW
Mode	SA, WCDMA, C2K, WIMAX OFDMA, 1xEVDO, DVB-T/H, DTMB (CTTB), ISDB-T, CMMB, LTE, LTETDD, Digital Cable TV, WLAN, MSR
Remote Command	[:SENSe]:CHPower:BANDwidth:VIDeo <bandwidth> [:SENSe]:CHPower:BANDwidth:VIDeo? [:SENSe]:CHPower:BANDwidth:VIDeo:AUTO ON OFF 1 0 [:SENSe]:CHPower:BANDwidth:VIDeo:AUTO?

Example	<p>CHP:BAND:VID 2.4 MHz</p> <p>CHP:BAND:VID?</p> <p>CHP:BAND:VID:AUTO OFF</p> <p>CHP:BAND:VID:AUTO?</p>
Notes	<p>You must be in the Spectrum Analysis mode, W-CDMA mode, cdma2000 mode, DVB-T/H mode, DTMB (CTTB) mode, ISDB-T mode, CMMB mode, Digital Cable TV mode, LTE mode, LTE TDD mode, WLAN mode, 1xEVDO mode, MSR or WIMAX OFDMA mode to use this command. Use :INSTrument:SElect to set the mode.</p>
Dependencies	<p>See Couplings</p>
Couplings	<p>Video bandwidth (VBW) is coupled to the RBW. As the resolution bandwidth changes, the video bandwidth (if set to Auto) changes to maintain the ratio set by VBW/RBW.</p> <p>Sweep Time is coupled to the Video Bandwidth (VBW). As the VBW is changed, the sweep time (when set to Auto) is changed to maintain amplitude calibration. This occurs because of common hardware between the two circuits, even though the Video BW filter is not actually “in-circuit” when the detector is set to Average. Because the purpose of the average detector and the VBW filter are the same, either can be used to reduce the variance of the result.</p> <p>Although the VBW filter is not “in-circuit” when using the average detector, the Video BW key can have an effect on (Auto) sweep time, and is not disabled. In this case, reducing the VBW setting increases the sweep time, which increases the averaging time, producing a lower-variance trace.</p> <p>When using the average detector with either Sweep Time set to Man, or in zero span, the VBW setting has no effect and is disabled (grayed out).</p> <p>When the video bandwidth is AUTO coupled, the video bandwidth value is set to:</p> <p>Resolution Bandwidth * Video Bandwidth to Resolution Bandwidth Ratio</p>

Channel Power Measurement
BW

Preset	SA: Auto WCDMA: 2.4MHz C2K: 240 kHz WIMAX OFDMA: Auto 1xEVDO: 300 kHz DVB-T/H: 39kHz DTMB (CTTB): 39kHz ISDB-T: 300kHz CMMB: 39kHz LTE, MSR: Auto LTETDD: Auto Digital Cable TV: 39kHz WLAN: Auto ON
State Saved	Saved in instrument state.
Min	1 Hz
Max	50 MHz
Initial S/W Revision	Prior to A.02.00
Modified at S/W Revision	A.02.00, A.03.00

Filter Type

Selects the type of bandwidth filter that is used. The choices are Gaussian or Flat top.

Key Path	BW
Mode	SA, WCDMA, C2K, WIMAX OFDMA, 1xEVDO, DVB-T/H, DTMB (CTTB), ISDB-T, CMMB, LTE, LTETDD, Digital Cable TV, WLAN, MSR
Remote Command	[:SENSe]:CHPower:BANDwidth:SHAPE GAUSSian FLATtop [:SENSe]:CHPower:BANDwidth:SHAPE?
Example	CHP:BAND:SHAP GAUS CHP:BAND:SHAP?
Preset	GAUSSian
State Saved	Saved in instrument state.
Range	Gaussian Flattop
Backwards Compatibility SCPI	[:SENSe]:CHPower:BWIDth:SHAPE

Initial S/W Revision	Prior to A.02.00
Modified at S/W Revision	A.02.00, A.03.00

Cont

See “[Cont \(Continuous Measurement/Sweep\)](#)” on page 1413 in the "Common Measurement Functions" section for more information.

Key Path	Front-panel key
----------	------------------------

FREQ Channel

See [“FREQ Channel” on page 1414](#) for more information.

Key Path	Front-panel key
----------	-----------------

Input/Output

See “[Input/Output](#)” on page 1422 for more information.

Key Path	Front-panel key
----------	-----------------

Marker

Accesses a menu that enables you to select, set up and control the markers for the current measurement.

Key Path	Front-panel key
Initial S/W Revision	Prior to A.02.00

Select Marker

Displays 12 markers available for selection.

Key Path	Marker
Initial S/W Revision	Prior to A.02.00

Marker Type

Sets the marker control mode to **Normal**, **Delta**, **Fixed** or **Off**. All interactions and dependencies detailed under the key description are enforced when the remote command is sent. If the selected marker is Off, pressing Marker sets it to Normal and places it at the center of the screen on the trace determined by the **Marker Trace** rules. At the same time, **Marker X Axis Value** appears on the Active Function area.

The default active function is the active function for the currently selected marker control mode. If the current control mode is Off, there is no active function and the active function is turned off.

Key Path	Marker
Mode	SA, WCDMA, C2K, WIMAX OFDMA, 1xEVDO, DVB-T/H, DTMB (CTTB), ISDB-T, CMMB, LTE, LTETDD, Digital Cable TV, WLAN, MSR
Remote Command	:CALCulate:CHPower:MARKer[1] 2 3 4 5 6 7 8 9 10 11 12:MODE POSITION DELTA OFF :CALCulate:CHPower:MARKer[1] 2 3 4 5 6 7 8 9 10 11 12:MODE?
Example	CALC:CHP:MARK3:MODE POS CALC:CHP:MARK3:MODE?
Notes	If the selected marker is Off, pressing Marker sets it to Normal and places it at the center of the screen on the trace determined by the Marker Trace rules. At the same time, Marker X Axis Value appears on the Active Function area. Default Active Function: the active function for the selected marker's current control mode. If the current control mode is Off, there is no active function and the active function is turned off. Active Function Display: the marker X axis value entered in the active function area displays the marker value to its full entered precision.
Preset	OFF

State Saved	Saved in instrument state.
Range	Normal Delta Off
Initial S/W Revision	Prior to A.02.00
Modified at S/W Revision	A.02.00, A.03.00

Marker X Axis Value (Remote Command Only)

Sets the marker X Axis value in the current marker X Axis Scale unit. It has no effect if the control mode is **Off**, but is the SCPI equivalent of entering an X value if the control mode is **Normal**, **Delta**, or **Fixed**.

Mode	SA, WCDMA, C2K, WIMAX OFDMA, 1xEVDO, DVB-T/H, DTMB (CTTB), ISDB-T, CMMB, LTE, LTETDD, Digital Cable TV, WLAN, MSR
Remote Command	:CALCulate:CHPower:MARKer[1] 2 3 4 5 6 7 8 9 10 11 12:X <real> :CALCulate:CHPower:MARKer[1] 2 3 4 5 6 7 8 9 10 11 12:X ?
Example	CALC:CHP:MARK3:X 0 CALC:CHP:MARK3:X?
Notes	The query returns the marker's absolute X Axis value if the control mode is Normal , or the offset from the marker's reference marker if the control mode is Delta . The query is returned in the fundamental units for the current marker X Axis scale: Hz for Frequency .
Preset	After a preset, all markers are turned OFF, so Marker X Axis Value query returns a not a number (NAN).
State Saved	Saved in instrument state.
Min	-9.9E+37
Max	9.9E+37
Initial S/W Revision	Prior to A.02.00
Modified at S/W Revision	A.02.00, A.03.00

Marker X Axis Position (Remote Command Only)

Sets the marker X Axis Scale position in trace points. This setting has no effect if the control mode is **Off**, but is the SCPI equivalent of entering a value if the control mode is **Normal** or **Delta**. The entered value is immediately translated into the current X Axis Scale units for setting the value of the marker.

Mode	SA, WCDMA, C2K, WIMAX OFDMA, 1xEVDO, DVB-T/H, DTMB (CTTB), ISDB-T, CMMB, LTE, LTETDD, Digital Cable TV, WLAN, MSR
------	---

Remote Command	:CALCulate:CHPower:MARKer[1] 2 3 4 5 6 7 8 9 10 11 12:X :POSition <real> :CALCulate:CHPower:MARKer[1] 2 3 4 5 6 7 8 9 10 11 12:X :POSition?
Example	CALC:CHP:MARK10:X:POS 0 CALC:CHP:MARK10:X:POS?
Notes	The query returns the marker's absolute X Axis value in trace points if the control mode is Normal , or the offset from the marker's reference marker in trace points if the control mode is Delta .
Preset	After a preset, all markers are turned OFF, so Marker X Axis Value query returns a not a number (NaN).
State Saved	Saved in instrument state.
Min	-9.9E+37
Max	9.9E+37
Initial S/W Revision	Prior to A.02.00
Modified at S/W Revision	A.02.00, A.03.00

Marker Y Axis Value (Remote Command only)

Returns the marker Y Axis value in the current marker Y Axis unit.

Mode	SA, WCDMA, C2K, WIMAX OFDMA, 1xEVDO, DVB-T/H, DTMB (CTTB), ISDB-T, CMMB, LTE, LTETDD, Digital Cable TV, WLAN, MSR
Remote Command	:CALCulate:CHPower:MARKer[1] 2 3 4 5 6 7 8 9 10 11 12:Y ?
Example	CALC:CHP:MARK11:Y?
Preset	Result dependent on Markers setup and signal source.
State Saved	Saved in instrument state.
Initial S/W Revision	Prior to A.02.00
Modified at S/W Revision	A.02.00, A.03.00

Properties

Accesses the marker properties menu.

Key Path	Marker
Initial S/W Revision	Prior to A.02.00

Select Marker

Displays 12 markers available for selection.

Key Path	Marker
Initial S/W Revision	Prior to A.02.00

Relative To

Sets the reference marker to which the selected marker is relative.

Key Path	Marker, Properties
Mode	SA, WCDMA, C2K, WIMAX OFDMA, 1xEVDO, DVB-T/H, DTMB (CTTB), ISDB-T, CMMB, LTE, LTETDD, Digital Cable TV, WLAN, MSR
Remote Command	:CALCulate:CHPower:MARKer[1] 2 3 4 5 6 7 8 9 10 11 12:REference <integer> :CALCulate:CHPower:MARKer[1] 2 3 4 5 6 7 8 9 10 11 12:REference?
Example	CALC:CHP:MARK:REF 5 CALC:CHP:MARK:REF?
Notes	A marker cannot be relative to itself so that choice is grayed out, and if sent from SCPI generates error -221: "Settings conflict; marker cannot be relative to itself." When queried, a single value is returned (the specified marker numbers relative marker). You must be in the Spectrum Analysis or WCDMA mode to use this command. Use :INSTrument:SElect to set the mode.
Preset	2 3 4 5 6 7 8 9 10 11 12 1
State Saved	Saved in instrument state.
Min	1
Max	12
Initial S/W Revision	Prior to A.02.00
Modified at S/W Revision	A.02.00, A.03.00

Marker Trace (DVB-T/H and DTMB (CTTB) only)

Accesses a menu that allows you to assign a specified marker to the designated trace. This function is only valid for DVB-T/H and DTMB (CTTB) mode.

Key Path	Marker, Properties
Mode	DVB-T/H, DTMB (CTTB)

Remote Command	:CALCulate:CHPower:MARKer[1] 2 3 4 5 6 7 8 9 10 11 12:TRACe RFSPpectrum LShoulder RShoulder MASK :CALCulate:CHPower:MARKer[1] 2 3 4 5 6 7 8 9 10 11 12:TRACe?
Example	CALC:CHP:MARK:TRAC RFSP CALC:CHP:MARK:TRAC?
Preset	RFSPpectrum
State Saved	Saved in instrument state.
Range	RF Spectrum Left Shoulder Right Shoulder Spectrum Mask
Initial S/W Revision	A.02.00

Marker Trace(ISDB-T and CMMB only)

Accesses a menu that allows you to assign a specified marker to the designated trace. This function is only valid for ISDB-T and CMMB mode.

Key Path	Marker, Properties
Mode	ISDB-T, CMMB
Remote Command	:CALCulate:CHPower:MARKer[1] 2 3 4 5 6 7 8 9 10 11 12:TRACe RFSPpectrum LShoulder RShoulder :CALCulate:CHPower:MARKer[1] 2 3 4 5 6 7 8 9 10 11 12:TRACe?
Example	CALC:CHP:MARK:TRAC RFSP CALC:CHP:MARK:TRAC?
Preset	RFSPpectrum
State Saved	Saved in instrument state.
Range	RF Spectrum Left Shoulder Right Shoulder
Initial S/W Revision	A.02.00
Modified at S/W Revision	A.03.00

Couple Markers

When this function is active, moving any marker causes an “equal X Axis movement” of every other marker that is not set to **Off**. By “equal X Axis movement” we mean that we preserve the difference between each marker’s X Axis value (in the fundamental x-axis units of the trace that marker is on) and the X Axis value of the marker being moved (in the same fundamental x-axis units).

This may result in markers going off screen.

Key Path	Marker
-----------------	---------------

Channel Power Measurement
Marker

Mode	SA, WCDMA, C2K, WIMAX OFDMA, 1xEVDO, DVB-T/H, DTMB (CTTB), ISDB-T, CMMB, LTE, LTETDD, Digital Cable TV, WLAN, MSR
Remote Command	:CALCulate:CHPower:MARKer:COUPle[:STATe] ON OFF 1 0 :CALCulate:CHPower:MARKer:COUPle[:STATe]?
Example	CALC:CHPower:MARK:COUP ON
Preset	OFF
State Saved	Saved in instrument state.
Range	On Off
Initial S/W Revision	A.02.00

All Markers Off

Turns off all markers.

Key Path	Marker
Mode	SA, WCDMA, C2K, WIMAX OFDMA, 1xEVDO, DVB-T/H, DTMB (CTTB), ISDB-T, CMMB, LTE, LTETDD, Digital Cable TV, WLAN, MSR
Remote Command	:CALCulate:CHPower:MARKer:AOff
Example	CALC:CHP:MARK:AOff
Initial S/W Revision	Prior to A.02.00
Modified at S/W Revision	A.02.00, A.03.00

Backward Compatibility SCPI Commands

Sets or queries the state of a marker. Setting a marker which is OFF to state ON or 1 puts it in Normal mode and places it at the center of the screen.

Mode	SA, WCDMA, C2K, WIMAX OFDMA, 1xEVDO, DVB-T/H, DTMB (CTTB), ISDB-T, CMMB, LTE, LTETDD, Digital Cable TV, WLAN, MSR
Remote Command	:CALCulate:CHPower:MARKer[1] 2 3 4 5 6 7 8 9 10 11 12:STATe OFF ON 0 1 :CALCulate:CHPower:MARKer[1] 2 3 4 5 6 7 8 9 10 11 12:STATe?
Example	CALC:CHP:MARK3:STAT ON CALC:CHP:MARK3:STAT?
Preset	OFF
State Saved	Saved in instrument state.
Range	On Off

Initial S/W Revision	Prior to A.02.00
Modified at S/W Revision	A.02.00, A.03.00

Marker Function

There are no 'Marker Functions' supported in Channel Power, so this front-panel key displays a blank menu when pressed.

Key Path	Front-panel key
Initial S/W Revision	Prior to A.02.00

Marker To

There is no 'Marker To' functionality supported in Channel Power measurement, so this front-panel key displays a blank key menu when pressed.

Key Path	Front-panel key
Initial S/W Revision	Prior to A.02.00

Meas

See “[Meas](#)” on page 1520 for more information.

Key Path	Front-panel key
----------	-----------------

Meas Setup

Displays the setup menu for the currently selected measurement. The parameters included in this menu are as follows.

- Averaging
- IF Gain
- Channel Power Span
- Integrated Bandwidth
- Filter Bandwidth
- Root Raised Cosine (RRC) Filter

Key Path	Front-panel key
Initial S/W Revision	Prior to A.02.00

Avg/Hold Num

Specifies the number of measurement averages used to calculate the measurement result. The average is displayed at the end of each sweep. After the specified number of average counts, the averaging mode (terminal control) setting determines the averaging action.

Key Path	Meas Setup
Mode	SA, WCDMA, C2K, WIMAX OFDMA, 1xEVDO, DVB-T/H, DTMB (CTTB), ISDB-T, CMMB, LTE, LTE TDD, Digital Cable TV, WLAN, MSR
Remote Command	[:SENSE] :CHPower:AVERage:COUNT <integer> [:SENSE] :CHPower:AVERage:COUNT? [:SENSE] :CHPower:AVERage[:STATe] ON OFF 1 0 [:SENSE] :CHPower:AVERage[:STATe]?
Example	CHP:AVER:COUN 15 CHP:AVER:COUN? CHP:AVER ON CHP:AVER?
Notes	You must be in the Spectrum Analysis mode, W-CDMA mode, cdma2000 mode, DVB-T/H mode, DTMB (CTTB) mode, ISDB-T mode, CMMB mode, Digital Cable TV mode, LTE mode, LTE TDD mode 1xEVDO mode or WIMAX OFDMA mode to use this command. Use :INSTrument:SELEct to set the mode.

Channel Power Measurement
Meas Setup

Preset	SA: 10 WCDMA: 200 WIMAX OFDMA, LTE, LTETDD, MSR: 200 CDMA2K: 20 1xEVDO: 20 DVB-T/H: 20 DTMB (CTTB): 20 ISDB-T: 10 CMMB: 10 Digital Cable TV: 10 WLAN: 10 ON
State Saved	Saved in instrument state.
Min	1
Max	10000
Initial S/W Revision	Prior to A.02.00
Modified at S/W Revision	A.02.00, A.03.00

Avg Mode

Allows you to select the type of termination control used for the averaging function. This determines the averaging action after the specified number of data acquisitions (average count) is reached.

When set to Exponential (Exp) the measurement averaging continues using the specified number of averages to compute each exponentially-weighted averaged value. The average is displayed at the end of each sweep.

When set to Repeat, the measurement resets the average counter each time the specified number of averages is reached.

Key Path	Meas Setup
Mode	SA, WCDMA, C2K, WIMAX OFDMA, 1xEVDO, DVB-T/H, DTMB (CTTB), ISDB-T, CMMB, LTE, LTETDD, Digital Cable TV, WLAN, MSR
Remote Command	[:SENSe]:CHPower:AVERage:TCONtrol EXPonential REPeat [:SENSe]:CHPower:AVERage:TCONtrol?
Example	CHP:AVER:TCON EXP CHP:AVER:TCON?

Notes	You must be in the Spectrum Analysis mode, W-CDMA mode, cdma2000 mode, DVB-T/H mode, DTMB (CTTB) mode, ISDB-T mode, CMMB mode, Digital Cable TV mode, LTE mode, LTE TDD mode, WLAN mode, 1xEVDO mode or WIMAX OFDMA mode to use this command. Use :INSTrument:SElect to set the mode.
Preset	EXP
State Saved	Saved in instrument state.
Range	Exp Repeat
Initial S/W Revision	Prior to A.02.00
Modified at S/W Revision	A.02.00, A.03.00

Integ BW

Specifies the range of integration used in calculating the power in the channel. The integration bandwidth (IBW) is displayed on the trace as two markers connected by an arrow.

Key Path	Meas Setup
Mode	SA, WCDMA, C2K, WIMAX OFDMA, 1xEVDO, DVB-T/H, DTMB (CTTB), ISDB-T, CMMB, LTE, LTE TDD, Digital Cable TV, WLAN
Remote Command	[:SENSE]:CHPower:BANDwidth:INTEgration <bandwidth> [:SENSE]:CHPower:BANDwidth:INTEgration?
Example	CHP:BAND:INT 10MHz CHP:BAND:INT?
Notes	You must be in the Spectrum Analysis mode, W-CDMA mode, cdma2000 mode, DVB-T/H mode, DTMB (CTTB) mode, ISDB-T mode, CMMB mode, Digital Cable TV mode, LTE mode, LTE TDD mode, WLAN mode, 1xEVDO mode or WIMAX OFDMA mode to use this command. Use :INSTrument:SElect to set the mode.
Dependencies	For MSR mode, this key is blank.
Couplings	The minimum value of the span is coupled with the integration bandwidth.

Channel Power Measurement
Meas Setup

Preset	SA: 2 MHz WCDMA: 5 MHz C2K: 1.23 MHz WIMAX OFDMA: 10 MHz 1xEVDO: 1.23 MHz DVB-T/H: 7.61MHz DTMB (CTTB): 8MHz ISDB-T: 5.6MHz CMMB: 8MHz LTE: 5 MHz LTETDD: 5 MHz Digital Cable TV: 8MHz WLAN: if Radio Std is 802.11a/g(OFDM/DSSS-OFDM): 16.6 MHz if Radio Std is 802.11b: 22 MHz if Radio Std is 802.11n(20MHz): 17.8 MHz if Radio Std is 802.11n(40MHz): 36.6 MHz
State Saved	Saved in instrument state.
Min	100 Hz
Max	1 GHz
Max	RF Input: 1 GHz
Initial S/W Revision	Prior to A.02.00
Modified at S/W Revision	A.02.00, A.03.00

Carrier Results (Only for MSR)

Enables you to view and scroll through the carrier power results.

Key Path	Meas Setup
Mode	MSR
Couplings	This key will be grayed out if there is only one carrier.
State Saved	No
Initial S/W Revision	A.10.00

PhNoise Opt

Selects the LO (local oscillator) phase noise behaviour for various operating conditions.

Key Path	Meas Setup
Initial S/W Revision	A.04.20

PhNoise Opt Auto

Selects the LO (local oscillator) phase noise behavior to optimize dynamic range and speed for various instrument operating conditions.

The X-Series has two grades of LO; a high performance LO that gives the best phase noise performance; and a medium-performance LO that gives excellent performance.

In models with the high performance LO, Auto will choose:

Fast Tuning whenever Span > 44.44 MHz or RBW > 1.9 MHz

otherwise, if center frequency is < 195 kHz OR ALL of the following are true:

CF 1 MHz AND Span 1.3 MHz AND RBW 75 kHz

then Best Close in Phase Noise;

otherwise, Best Wide-offset Phase Noise

In models with the medium-performance LO, Auto will choose:

Fast Tuning whenever Span > 12.34 MHz or RBW > 250 kHz

otherwise, if center frequency is < 25 kHz OR ALL of the following are true:

CF >= 1 MHz AND Span <= 141.4 kHz AND RBW <= 5 kHz

then **Best Close in Phase Noise**;

otherwise, **Best Wide-offset Phase Noise**

In units whose hardware does not provide for an extra-fast tuning option, the settings for Fast Tuning are the same as Best Close-in, so in those models you will see no difference between these settings.

These rules apply whether in swept spans, zero span, or FFT spans.

Key Path	Meas Setup
Remote Command	[:SENSe] :CHPower:FREQuency:SYNThesis:AUTO[:STATe] OFF ON 0 1 [:SENSe] :CHPower:FREQuency:SYNThesis:AUTO[:STATe] ?
Example	CHP:FREQ:SYNT:AUTO 1 CHP:FREQ:SYNT:AUTO?
Preset	OFF
State Saved	Saved in instrument state.

Channel Power Measurement
Meas Setup

Range	Auto Man
Readback Text	“Auto” is underlined when Auto is selected, otherwise Man is underlined.
Initial S/W Revision	A.04.20

PhNoise Opt State

Selects the LO (local oscillator) phase noise behavior for various operating conditions.

Key Path	Meas Setup
Remote Command	[:SENSe] :CHPower :FREQuency :SYNTHeSis [:STATe] 1 2 3 [:SENSe] :CHPower :FREQuency :SYNTHeSis [:STATe] ?
Example	CHP:FREQ:SYNT 1 CHP:FREQ:SYNT?
Notes	Parameter key: <ol style="list-style-type: none"> 1. optimizes phase noise for close-in from the carrier. 2. optimizes phase noise for wide-offset from the carrier. 3. optimizes LO for tuning speed.
Preset	3
State Saved	Saved in instrument state.
Range	Hardware Dependent: PXA: Best Close-in Noise [offset < 140 kHz] Best Wide-offset Noise [offset > 160 kHz] Fast Tuning MXA, CXA: Best Close-in Noise [offset < 20 kHz] Best Wide-offset Noise [offset > 30 kHz] Fast Tuning
Initial S/W Revision	A.04.20

IF Gain

Sets the IF Gain function to Auto, Low Gain or High Gain. These settings affect sensitivity and IF overloads.

Key Path	Meas Setup
Initial S/W Revision	Prior to A.02.00

IF Gain Auto

Activates the auto rules for IF Gain. When Auto is active, the IF Gain is set to High Gain under any of the following conditions:

- The input attenuator is set to 0 dB

- The preamp is turned On and the frequency range is under 3.6 GHz

For other settings, Auto sets the IF Gain to Low Gain.

Key Path	Meas Setup, IF Gain
Remote Command	[:SENSe] :CHPower : IF : GAIN : AUTO [: STATE] ON OFF 1 0 [:SENSe] :CHPower : IF : GAIN : AUTO [: STATE] ?
Example	CHP:IF:GAIN:AUTO ON CHP:IF:GAIN:AUTO?
Couplings	When the auto attenuation exists (for example, with an electrical attenuator), IF Gain State differs depending on the condition. Auto sets IF Gain to High Gain under any of the following conditions: The input attenuator is set to 0 dB, or the preamp is turned on and the frequency range is under 3.6 GHz. For other conditions, Auto sets IF Gain to Low Gain.
Preset	OFF
State Saved	Saved in instrument state.
Range	Off On
Initial S/W Revision	Prior to A.02.00

IF Gain State

Selects the range of the IF Gain.

Key Path	Meas Setup, IF Gain
Remote Command	[:SENSe] :CHPower : IF : GAIN [: STATE] ON OFF 1 0 [:SENSe] :CHPower : IF : GAIN [: STATE] ?
Example	CHP : IF : GAIN ON CHP : IF : GAIN ?
Notes	ON = high gain OFF = low gain
Couplings	When the auto attenuation exists (for example, with an electrical attenuator), IF Gain State differs depending on the condition. Auto sets IF Gain to High Gain under any of the following conditions: The input attenuator is set to 0 dB, or the preamp is turned on and the frequency range is under 3.6 GHz. For other conditions, Auto sets IF Gain to Low Gain.
Preset	OFF
State Saved	Saved in instrument state.

Channel Power Measurement
Meas Setup

Range	Low Gain High Gain
Initial S/W Revision	Prior to A.02.00

Method

Turns the Root Raised Cosine (RRC) filter On or Off. The α value (roll off) for the filter is set to the value of the Filter Alpha parameter, and the RRC filter bandwidth is set to the Filter BW parameter.

Key Path	Meas Setup
Mode	SA, WCDMA,WIMAX OFDMA, DVB-T/H, DTMB (CTTB), ISDB-T, CMMB, LTE, LTETDD, Digital Cable TV, WLAN
Remote Command	[:SENSe]:CHPower:FILTer[:RRC][:STATE] OFF ON 0 1 [:SENSe]:CHPower:FILTer[:RRC][:STATE]?
Example	CHP:FILT OFF CHP:FILT?
Notes	This parameter is normally used when TETRA is selected as the Radio Std. You must be in the Spectrum Analysis mode, DVB-T/H mode, DTMB (CTTB) mode, ISDB-T mode, CMMB mode, LTE mode, LTE TDD mode, WLAN mode,WIMAX OFMDA mode or W-CDMA mode to use this command. Use :INSTrument:SElect to set the mode.
Dependencies	For CDMA2K mode, this key is blank. For 1xEVDO mode, this key is blank. For MSR mode, this key is blank.
Preset	OFF
State Saved	Saved in instrument state.
Range	Integ BW RRC Weighted
Initial S/W Revision	Prior to A.02.00
Modified at S/W Revision	A.02.00, A.03.00, A.10.00

Filter Alpha

Inputs the alpha value for the Root Raised Cosine (RRC) filter.

Key Path	Meas Setup, Method
Mode	SA, WCDMA,WIMAX OFDMA, DVB-T/H, DTMB (CTTB), ISDB-T, CMMB, LTE, LTETDD, Digital Cable TV, WLAN
Remote Command	[:SENSe]:CHPower:FILTer[:RRC]:ALPHA <real> [:SENSe]:CHPower:FILTer[:RRC]:ALPHA?

Example	CHP:FILT:ALPH 0.5 CHP:FILT:ALPH?
Notes	This parameter is normally used when TETRA is selected as the Radio Std. You must be in the Spectrum Analysis mode, DVB-T/H mode, DTMB (CTTB) mode, ISDB-T mode, CMMB mode, LTE mode, LTE TDD mode, WLAN mode, WIMAX OFMDA mode or W-CDMA mode to use this command. Use :INSTrument:SELEct to set the mode.
Dependencies	For CDMA2K mode, this key is blank. For 1xEVDO mode, this key is blank. For MSR mode, this key is blank.
Preset	SA, WCDMA,, WIMXA OFMDA, DVB-T/H, ISDB-T, CMMB, LTE, LTETDD, WLAN: 0.22 DTMB (CTTB): 0.05 Digital Cable TV: 0.15
State Saved	Saved in instrument state.
Min	0.01
Max	1.00
Initial S/W Revision	Prior to A.02.00
Modified at S/W Revision	A.02.00, A.03.00, A.10.00

Filter BW

Inputs the Root Raised Cosine (RRC) filter bandwidth. Normally, the filter bandwidth is the same as the symbol rate of the signal.

Key Path	Meas Setup, Method, RRC Weighted
Mode	SA, WCDMA, WIMAX OFDMA, DVB-T/H, DTMB (CTTB), ISDB-T, CMMB, LTE, LTETDD, Digital Cable TV, WLAN
Remote Command	[:SENSE] :CHPower :FILTer [:RRC] :BANDwidth <real> [:SENSE] :CHPower :FILTer [:RRC] :BANDwidth?
Example	CHP:FILT:BAND 10MHz CHP:FILT:BAND?
Notes	This parameter is normally used when TETRA is selected as the Radio Std. You must be in the Spectrum Analysis mode, DVB-T/H mode, DTMB (CTTB) mode, ISDB-T mode, CMMB mode, LTE mode, LTE TDD mode, WLAN mode, WIMAX OFMDA mode or W-CDMA mode to use this command. Use :INSTrument:SELEct to set the mode.

Channel Power Measurement
Meas Setup

Dependencies	For CDMA2K mode, this key is blank. For 1xEVDO mode, this key is blank. For MSR mode, this key is blank.
Preset	SA, LTE, LTETDD: 3.84MHz WCDMA: 3.84MHz WIMAX OFDMA: 10MHz DVB-T/H: 8MHz DTMB (CTTB): 7.56MHz ISDB-T: 5.6MHz CMMB: 7.512MHz Digital Cable TV: 6.9MHz WLAN: if Radio Std is 802.11a/g(OFDM/DSSS-OFDM): 16.6 MHz if Radio Std is 802.11b: 22 MHz if Radio Std is 802.11n(20MHz): 17.8 MHz if Radio Std is 802.11n(40MHz): 36.6 MHz
State Saved	Saved in instrument state.
Min	100 Hz
Max	100 MHz
Backwards Compatibility SCPI	[:SENSe]:CHPower:FILTer[:RRC]:BWIDth
Initial S/W Revision	Prior to A.02.00
Modified at S/W Revision	A.02.00, A.03.00, A.10.00

Limits

Accesses the Limits menu that allows you to set up the test limit for channel power or power spectral density.

When DVB-T/H mode or DTMB (CTTB) mode is selected or DVB-T radio standard is selected in SA mode, this functionality is disabled and input signal will be compared against pre-defined spectrum mask, instead. See 1.3.2 Limit Line Mask for DVB-T for more details.

In DVB-T/H, DTMB (CTTB), ISDB-T, CMMB mode, this key is blank. If DVB-T is selected as current Radio Std in SA Mode, this key is grayed out. TODO: Need to assign gray out message.

In MSR this feature is not supported and the key is blank because the power of each carrier may be different.

Key Path	Meas Setup
Initial S/W Revision	A.xx.xx

Power Limit

If Power Limit is on, Power Limit is used as threshold which can judge whether the real measured channel power can be passed or not. If real measured channel power exceeds Power Limit, channel power test fails, otherwise, it passes. If Power Limit is off, channel power test is always passed.

Key Path	Meas Setup, Limits
Mode	SA, WCDMA, C2K, WIMAX OFDMA, 1xEVDO, LTE, LTETDD, Digital Cable TV, WLAN
Remote Command	:CALCulate:CHPower:LIMit:POWer <ampl> :CALCulate:CHPower:LIMit:POWer? :CALCulate:CHPower:LIMit:POWer:STATe OFF ON 0 1 :CALCulate:CHPower:LIMit:POWer:STATe?
Example	CALC:CHP:LIM:POW 16.00 CALC:CHP:LIM:POW? CALC:CHP:LIM:POW:STAT ON CALC:CHP:LIM:POW:STAT?
Notes	This parameter and PSD Limit can determine Pass/Fail criteria. If ((power limit = On) and (PSD limit= Off)) Pass if (power test passes) Fail if (power test fails) If ((power limit = On) and (PSD limit= On)) Pass if (both power test and PSD test pass) Fail if (either of power test or PSD test fails) If ((power limit = Off) and (PSD limit= On)) Pass if (PSD test passes) Fail if (PSD test fails) If ((power limit = Off) and (PSD limit= Off)) Always Pass For MSR mode, this key is blank.
Preset	16.00 SA, WCDMA, C2K, WIMAX OFDMA, 1xEVDO, DVB-T/H, DTMB (CTTB), LTE, LTETDD, Digital Cable TV: OFF WLAN: ON
State Saved	Saved in instrument state.
Min	-200.0
Max	200.0

Channel Power Measurement
Meas Setup

Initial S/W Revision	A.10.00
----------------------	---------

Power Limit Fail (remote command only)

The command is query only and used to query if power test passes or fails. When DVB-T/H mode or DTMB (CTTB) mode is selected or DVB-T radio standard is selected in SA mode, this query scpi command does not make any sense.

Remote Command	:CALCulate:CHPower:LIMit:POWer:FAIL?
Example	CALC:CHP:LIM:POW:FAIL?
Notes	This command is query only. When Power Limit is off, the returned value is always 0 (pass). When Power Limit is on, the returned value is 0(pass) while power test passes and 1(fail) while power test fails. In MSR this feature is not supported.
Initial S/W Revision	A.10.00

PSD Limit

If PSD (power spectral density) Limit is ON, PSD Limit is used as threshold which can judge whether the real measured PSD can be passed or not. If real measured PSD exceeds PSD Limit, PSD test fails, otherwise, it passes. If PSD is off, PSD test is always passed.

Key Path	Meas Setup, Limits
Mode	SA, WCDMA, C2K, WIMAX OFDMA, 1xEVDO, LTE, LTETDD, Digital Cable TV, WLAN
Remote Command	:CALCulate:CHPower:LIMit:PSDensity <real> :CALCulate:CHPower:LIMit:PSDensity? :CALCulate:CHPower:LIMit:PSDensity:STATe OFF ON 0 1 :CALCulate:CHPower:LIMit:PSDensity:STATe?
Example	CALC:CHP:LIM:PSD 4.00 CALC:CHP:LIM:PSD? CALC:CHP:LIM:POW:STAT ON CALC:CHP:LIM:POW:STAT?

Notes	<p>This parameter and Power Limit can determine Pass/Fail criteria.</p> <p>If ((power limit = On) and (PSD limit= Off))</p> <p style="padding-left: 40px;">Pass if (power test passes)</p> <p style="padding-left: 40px;">Fail if (power test fails)</p> <p>If ((power limit = On) and (PSD limit= On))</p> <p style="padding-left: 40px;">Pass if (both power test and PSD test pass)</p> <p style="padding-left: 40px;">Fail if (either of power test or PSD test fails)</p> <p>If ((power limit = Off) and (PSD limit= On))</p> <p style="padding-left: 40px;">Pass if (PSD test passes)</p> <p style="padding-left: 40px;">Fail if (PSD test fails)</p> <p>If ((power limit = Off) and (PSD limit= Off))</p> <p style="padding-left: 40px;">Always Pass</p> <p>For MSR mode, this key is blank.</p>
Preset	<p>4.00</p> <p>SA, WCDMA, C2K, WIMAX OFDMA, 1Xevdo,LTE, LTETDD, Digital Cable TV: OFF</p> <p>WLAN: ON</p>
State Saved	Saved in instrument state.
Min	-200.0
Max	200.0
Initial S/W Revision	A.10.00
Coupling	The value is automatically converted when PSD Unit is changed.

PSD Limit Fail (remote command only)

The command is query only and used to query if PSD test passes or fails. When DVB-T/H mode or DTMB (CTTB) mode is selected or DVB-T radio standard is selected in SA mode, this query SCPI command does not make any sense.

Remote Command	:CALCulate:CHPower:LIMit:PSD:FAIL?
Example	CALC:CHP:LIM:PSD:FAIL?
Notes	<p>This command is query only.</p> <p>When PSD Limit is off, the returned value is always 0 (pass).</p> <p>When PSD Limit is on, the returned value is 0(pass) while PSD test passes and 1(fail) while PSD test fails.</p>
Initial S/W Revision	A.10.00

PSD Unit

Sets the unit bandwidth for Power Spectral Density. The available units are dBm/Hz and dBm/MHz.

Key Path	Meas Setup
Mode	SA, WCDMA, WIMAX OFDMA, 1xEVDO, DVB-T/H, DTMB (CTTB), LTE, LTETDD, Digital Cable TV, WLAN, MSR
Remote Command	:UNIT:CHPower:POWer:PSD DBMHZ DBMMHZ :UNIT:CHPower:POWer:PSD?
Example	UNIT:CHP:POW:PSD DBMMHZ UNIT:CHP:POW:PSD?
Couplings	When the PSD unit is changed, the PSD result of the “MEAS READ FETCH:CHP1?” is also changed by the PSD unit basis (in either dBm/Hz or dBm/MHz).
Preset	DBMHZ WLAN: DBMMHZ
State Saved	Saved in instrument state.
Range	dBm/Hz/dBm/MHz
Initial S/W Revision	Prior to A.02.00
Modified at S/W Revision	A.02.00, A.03.00

Meas Preset

Restores all the measurement parameters to their default values.

Key Path	Meas Setup
Mode	SA, WCDMA, C2K, WIMAX OFDMA, 1xEVDO, DVB-T/H, DTMB (CTTB), ISDB-T, CMMB, LTE, LTETDD, Digital Cable TV, WLAN, MSR
Remote Command	:CONFigure:CHPower
Example	CONF:CHP
Initial S/W Revision	Prior to A.02.00
Modified at S/W Revision	A.02.00, A.03.00

Shoulder Offset Start (Only for DVB-T/H and ISDB-T mode)

Specifies the start offset frequency from the center frequency used in calculating the shoulder attenuation results.

Key Path	Meas Setup
----------	------------

Mode	DVB-T/H, ISDB-T
Remote Command	[:SENSE] :CHPower :SHOUldeR :OFFSet :FREQuency :STARt <freq> [:SENSe] :CHPower :SHOUldeR :OFFSet :FREQuency :STARt?
Example	CHP:SHOU:OFFS:FREQ:STAR 3.3MHz CHP:SHOU:OFFS:FREQ:STAR?
Notes	You must be in the ISDB-T mode to use this command. Use :INSTrument:SElect to set the mode.
Couplings	The minimum value of the shoulder offset start frequency is coupled with integration bandwidth, the maximum value of the shoulder offset start frequency is coupled with shoulder offset stop frequency.
Preset	DVB-T/H: 4.105MHz ISDB-T: 3.3MHz
State Saved	Saved in instrument state.
Min	100 Hz
Max	1.0 GHz
Initial S/W Revision	A.03.00

Shoulder Offset Stop (Only for DVB-T/H and ISDB-T mode)

Specifies the stop offset frequency from the center frequency used in calculating the shoulder attenuation results.

Key Path	Meas Setup
Mode	DVB-T/H, ISDB-T
Remote Command	[:SENSE] :CHPower :SHOUldeR :OFFSet :FREQuency :STOP <freq> [:SENSe] :CHPower :SHOUldeR :OFFSet :FREQuency :STOP?
Example	CHP:SHOU:OFFS:FREQ:STOP 3.5MHz CHP:SHOU:OFFS:FREQ:STOP?
Notes	You must be in the ISDB-T mode to use this command. Use :INSTrument:SElect to set the mode.
Couplings	The minimum value of the shoulder offset stop frequency is coupled with shoulder offset start frequency, the maximum value of the shoulder offset stop frequency is coupled with span.
Preset	DVB-T/H: 4.505MHz ISDB-T: 3.5MHz
State Saved	Saved in instrument state.
Min	100 Hz

Channel Power Measurement
Meas Setup

Max	1.0 GHz
Initial S/W Revision	A.03.00

Shoulder Offset (Only for DTMB (CTTB) and CMMB mode)

Specifies the offset frequency from the center frequency used in calculating the shoulder attenuation results.

Key Path	Meas Setup
Mode	DTMB (CTTB), CMMB
Remote Command	[:SENSe] :CHPower :SHOUldeR :OFFSet :FREQuency <freq> [:SENSe] :CHPower :SHOUldeR :OFFSet :FREQuency?
Example	CHP:SHOU:OFFS:FREQ 4.2MHz CHP:SHOU:OFFS:FREQ?
Notes	You must be in the CMMB mode to use this command. Use :INSTrument:SElect to set the mode.
Couplings	The minimum value of the shoulder offset frequency is coupled with integration bandwidth, the maximum value of the shoulder offset frequency is coupled with span.
Preset	4.2MHz
State Saved	Saved in instrument state.
Min	100 Hz
Max	1.0 GHz
Initial S/W Revision	A.03.00

Mode

See [“Mode” on page 1534](#) for more information.

Key Path	Front-panel key
----------	-----------------

Mode Setup

See “[Mode Setup](#)” on page 1553 for more information.

Key Path	Front-panel key
----------	-----------------

Peak Search

Places the selected marker on the trace point with the maximum y-axis value. Pressing Peak Search with the selected marker Off causes the selected marker to be set to Normal, then a peak search is immediately performed.

Key Path	Front panel key
Mode	SA, WCDMA, C2K, WIMAX OFDMA, 1xEVDO, DVB-T/H, DTMB (CTTB), ISDB-T, CMMB, LTE, LTETDD, Digital Cable TV, WLAN, MSR
Remote Command	:CALCulate:CHPower:MARKer[1] 2 3 4 5 6 7 8 9 10 11 12:MAXimum
Example	CALC:CHP:MARK2:MAX
Initial S/W Revision	Prior to A.02.00
Modified at S/W Revision	A.02.0, A.03.000

Recall

See “[Recall](#)” on page 194 for more information.

Key Path	Front-panel key
Initial S/W Revision	Prior to A.02.00

Restart

See [“Restart” on page 1558](#) for more information.

Key Path	Front-panel key
----------	-----------------

Save

See “[Save](#)” on page 207 for more information.

Key Path	Front-panel key
----------	-----------------

Single

See [“Single \(Single Measurement/Sweep\)” on page 1563](#) for more information.

Key Path	Front-panel key
----------	-----------------

Source

See “[Source](#)” on page 1564 for more information.

Key Path	Front-panel key
----------	-----------------

Span X Scale

Accesses a menu of functions that enable you set the horizontal scale parameters.

Key Path	Front-panel key
Initial S/W Revision	Prior to A.02.00

Span

Changes the frequency range symmetrically about the center frequency.

The default (and minimum) Span is calculated using the number of carriers and the carrier width where;

$$\text{Span} = (\text{Upper Carrier Freq} + (\text{max offset IBW} * (1 + \alpha)) / 2) - (\text{Lower Carrier Freq} - (\text{max offset IBW} * (1 + \alpha)) / 2)$$

The span is increased by a factor of 1 + Filter Alpha if the RRC Filter is on.

Key Path	Span X Scale
Mode	SA, WCDMA, C2K, WIMAX OFDMA, 1xEVDO, DVB-T/H, DTMB (CTTB), ISDB-T, CMMB, LTE, LTETDD, Digital Cable TV, WLAN
Remote Command	[:SENSe] :CHPower :FREQuency :SPAN <freq> [:SENSe] :CHPower :FREQuency :SPAN?
Example	CHP:FREQ:SPAN 10 MHz CHP:FREQ:SPAN?
Notes	You must be in the Spectrum Analysis mode, W-CDMA mode, cdma2000 mode, DVB-T/H mode, DTMB (CTTB) mode, ISDB-T mode, CMMB mode, Digital Cable TV mode, LTE mode, LTE TDD mode, WLAN mode, 1xEVDO mode or WIMAX OFDMA mode to use this command. Use :INSTrument:SElect to set the mode.
Dependencies	For MSR mode, this key is blank.
Couplings	When Res BW is set to Auto, the resolution bandwidth is auto-coupled to span. The ratio of span /RBW is approximately 106:1. When the Res BW is set to Man, bandwidths are entered by the user, and these bandwidths are used regardless of other analyzer settings. Since Span is coupled to Integ BW in the factory default condition, if you change the integration bandwidth setting, the span setting changes by a proportional amount until a limit value is reached. However, the span can be individually set. The minimum value of the span is coupled with the integration bandwidth.

Channel Power Measurement
Span X Scale

Preset	SA: 3 MHz WCDMA: 7.5 MHz C2K: 1.845 MHz WIMAX OFDMA: 20 MHz 1xEVDO: 2.0MHz DVB-T/H: 10MHz DTMB (CTTB): 10MHz ISDB-T: 10MHz CMMB: 10MHz LTE: 7.5 MHz LTETDD: 7.5 MHz Digital Cable TV: 10MHz WLAN: if Radio Std is 802.11a/g(OFDM/DSSS-OFDM): 22 MHz if Radio Std is 802.11b: 25 MHz if Radio Std is 802.11n(20MHz): 20 MHz if Radio Std is 802.11n(40MHz): 40 MHz
State Saved	Saved in instrument state.
Min	100 Hz
Max	1 GHz
Max	RF Input: 1 GHz
Initial S/W Revision	Prior to A.02.00
Modified at S/W Revision	A.02.00, A.03.00

Full Span

Changes the span to show the full frequency range of the spectrum analyzer.

Key Path	Span X Scale
Mode	SA, WCDMA, C2K, WIMAX OFDMA, 1xEVDO, DVB-T/H, DTMB (CTTB), ISDB-T, CMMB, LTE, LTETDD, Digital Cable TV, WLAN
Remote Command	[:SENSe] :CHPower :FREQuency :SPAN :FULL
Example	CHP:FREQ:SPAN:FULL

Notes	You must be in the Spectrum Analysis mode, W-CDMA mode, cdma2000 mode, DVB-T/H mode, DTMB (CTTB) mode, ISDB-T mode, CMMB mode, Digital Cable TV mode, LTE mode, LTE TDD mode, WLAN mode, 1xEVDO mode or WIMAX OFDMA mode to use this command. Use :INSTrument:SElect to set the mode.
Dependencies	For MSR mode, this key is blank.
Couplings	Selecting full span changes the measurement span value.
Initial S/W Revision	Prior to A.02.00
Modified at S/W Revision	A.02.00, A.03.00

Last Span

Changes the span to the previous span setting. If no previous span value exists, then the span remains unchanged.

Key Path	Span X Scale
Mode	SA, WCDMA, C2K, WIMAX OFDMA, 1xEVDO, DVB-T/H, DTMB (CTTB), ISDB-T, CMMB, LTE, LTETDD, Digital Cable TV, WLAN
Remote Command	[:SENSe] :CHPower :FREQuency :SPAN :PREVious
Example	CHP:FREQ:SPAN:PREV
Notes	You must be in the Spectrum Analysis mode, W-CDMA mode, cdma2000 mode, DVB-T/H mode, DTMB (CTTB) mode, ISDB-T mode, CMMB mode, Digital Cable TV mode, LTE mode, LTE TDD mode, WLAN mode, 1xEVDO mode or WIMAX OFDMA mode to use this command. Use :INSTrument:SElect to set the mode.
Dependencies	For MSR mode, this key is blank.
Couplings	Selecting last span changes the measurement span value.
Initial S/W Revision	Prior to A.02.00
Modified at S/W Revision	A.02.00, A.03.00

Sweep/Control

Accesses a menu of functions that enable you to set up and control the sweep time and source for the current measurement. See “Sweep/Control” on page 1564 for more information.

Key Path	Front-panel key
Initial S/W Revision	Prior to A.02.00

Sweep Time

Selects the length of time that the spectrum analyzer sweeps the displayed frequency span. Additional overhead time, which impacts the sweep rate, is not calculated as part of the sweep time. In fact:

- sweep rate = span/sweep time
- update rate = 1/(sweep time + overhead)
- sweep cycle time = sweep time + overhead

Sweep time is coupled to RBW and VBW, and is impacted by the number of sweep points, so changing those parameters may change the sweep time.

Key Path	Sweep/Control
Mode	SA, WCDMA, C2K, WIMAX OFDMA, 1xEVDO, DVB-T/H, DTMB (CTTB), ISDB-T, CMMB, LTE, LTETDD, Digital Cable TV, WLAN, MSR
Remote Command	<pre>[:SENSe] :CHPower :SWEep :TIME <time> [:SENSe] :CHPower :SWEep :TIME? [:SENSe] :CHPower :SWEep :TIME :AUTO OFF ON 0 1 [:SENSe] :CHPower :SWEep :TIME :AUTO?</pre>
Example	<pre>CHP:SWE:TIME 25ms CHP:SWE:TIME? CHP:SWE:TIME:AUTO OFF CHP:SWE:TIME:AUTO?</pre>

Preset	SA, WIMAX OFDMA: Automatically Calculated WCDMA: 1.0 ms CDMA2K: 9.4ms 1xEVDO: 2.66ms DVB-T/H: Automatically Calculated DTMB (CTTB): Automatically Calculated ISDB-T: Automatically Calculated CMMB: Automatically Calculated LTE, MSR: Automatically Calculated LTETDD: Automatically Calculated Digital Cable TV: Automatically Calculated WLAN: Automatically Calculated
State Saved	Saved in instrument state.
Min	1 ms
Max	4000 s
Initial S/W Revision	Prior to A.02.00
Modified at S/W Revision	A.02.00, A.03.00

Sweep Setup

Accesses a menu that enables you to set the sweep state for the current measurement.

Key Path	Sweep/Control
Initial S/W Revision	Prior to A.02.00

Auto Sweep Time Rules

Switches the analyzer between normal and accuracy sweep states.

Setting **Auto Sweep Time** to **Accy** results in slower sweep times, usually about three times as long, but yields better amplitude accuracy for CW signals. The instrument amplitude accuracy specifications only apply when **Auto Sweep Time** is set to **Accy**.

Additional amplitude errors which occur when **Auto Sweep Time** is set to **Norm** are usually well under 0.1 dB, though this is not guaranteed. Because of the faster sweep times and still low errors, **Norm** is the preferred setting of **Auto Sweep Time**. **Auto Sweep Time** is set to **Norm** on a **Preset** or **Auto Couple**. This means that in the Preset or Auto Coupled state, instrument amplitude accuracy specifications do not apply.

Key Path	Sweep/Control, Sweep Setup
----------	-----------------------------------

Channel Power Measurement Sweep/Control

Mode	SA, WCDMA, C2K, WIMAX OFDMA, 1xEVDO, DVB-T/H, DTMB (CTTB), ISDB-T, CMMB, LTE, LTETDD, Digital Cable TV, WLAN, MSR
Remote Command	[:SENSe] :CHPower :SWEep :TIME :AUTO :RULes NORMal ACCuracy [:SENSe] :CHPower :SWEep :TIME :AUTO :RULes?
Example	CHP:SWE:TIME:AUTO:RUL NORM CHP:SWE:TIME:AUTO:RUL?
Notes	In Zero Span, this key is irrelevant and inaccessible (because the whole Sweep Setup menu is grayed out in Zero Span), however its settings can be changed remotely with no error indication. Set to Norm when Auto Couple is pressed or sent remotely
Preset	NORMal
State Saved	Saved in instrument state.
Range	Norm Accy
Initial S/W Revision	Prior to A.02.00
Modified at S/W Revision	A.02.00, A.03.00

Pause

Pauses a measurement after the current data acquisition is complete. When Paused, the label on the key changes to Resume. Pressing the Resume key resumes the measurement at the point it was at when paused. See [“Pause/Resume” on page 1577](#) in “Common Measurement Functions” section for more details.

Key Path	Sweep/Control
Initial S/W Revision	Prior to A.02.00

Gate

Accesses a menu that enables you to control the gating function. See [“Gate ” on page 1578](#) in "Common Measurement Functions" section for more details.

The Gate functionality is used to view signals best viewed by qualifying them with other events.

Key Path	Sweep/Control
Initial S/W Revision	Prior to A.02.00

Points

Sets the number of points per sweep. The resolution of setting the sweep time depends on the number of points selected. If Preset is selected, the number of points per sweep defaults to 1001. The current value

of points is displayed parenthetically, next to the sweep time in the lower-right corner of the display.

Changing the number of points has several effects on the analyzer. Since markers are read at the point location, the marker reading may change. All trace data is cleared.

Key Path	Sweep/Control
Mode	SA, WCDMA, C2K, WIMAX OFDMA, 1xEVDO, DVB-T/H, DTMB (CTTB), ISDB-T, CMMB, LTE, LTETDD, Digital Cable TV, WLAN, MSR
Remote Command	[:SENSe] :CHPower :SWEep :POINTs <integer> [:SENSe] :CHPower :SWEep :POINTs?
Example	CHP:SWE:POIN 501 CHP:SWE:POIN?
Notes	Whenever the number of sweep points changes: All trace data is erased Any traces with Update Off also go to Display Off (like going from View to Blank in the older analyzers) Sweep time is re-quantized Any limit lines that are on are updated If averaging/hold is on, averaging/hold starts over
Couplings	Whenever the number of sweep points changes, the sweep time is re-quantized.
Preset	DVB-T/H: 2001 DTMB (CTTB): 2001 Other: 1001 ISDB-T: 2001 CMMB: 2001 1xEVDO: 512 Digital Cable TV: 2001
State Saved	Saved in instrument state.
Min	101
Max	20001
Initial S/W Revision	Prior to A.02.00
Modified at S/W Revision	A.02.00, A.03.00

Trace/Detector

Accesses a menu of functions that enable you to control the detectors for the current measurement.

Key Path	Front-panel key
Initial S/W Revision	Prior to A.02.00

Trace Type

Allows you to select the type of trace you want to use for the current measurement. The first page of this menu contains a 1-of-N selection of the trace type (**Clear Write, Average, Max Hold, Min Hold**) for the selected trace.

Key Path	Trace/Detector
Mode	SA, WCDMA, C2K, WIMAX OFDMA, 1xEVDO, DVB-T/H, DTMB (CTTB), ISDB-T, CMMB, LTE, LTETDD, Digital Cable TV, WLAN, MSR
Remote Command	:TRACe:CHPower:TYPE WRITe AVERAge MAXHold MINHold :TRACe:CHPower:TYPE?
Example	TRAC:CHP:TYPE WRIT TRAC:CHP:TYPE?
Notes	WRITe = Clear Write AVERAge = Average MAXHold = Maximum Hold MINHold = Minimum Hold
Couplings	When Detector setting is “Auto” ([[:SENSe]:CHPower:DETEctor:AUTO?]), Detector ([[:SENSe]:CHPower:DETEctor[:FUNCTion]?]) switches aligning with the switch of this parameter: “NORMal” with WRITe (Clear Write), “AVERAge” with AVERAge, “POSitive (peak)” with MAXHold, and “NEGative (peak)” with MINHold.
Preset	AVERAge
State Saved	Saved in instrument state.
Range	ClearWrite Average MaxHold MinHold
Initial S/W Revision	Prior to A.02.00
Modified at S/W Revision	A.02.00, A.03.00

Detector

Accesses a menu of functions that enable you to control the detectors for the current measurement. The following choices are available:

- Auto- the detector selected depends on marker functions, trace functions, average type, and the trace averaging function.
- Normal-the detector determines the peak of the CW-like signals, and it yields alternating maximums and minimums of noise-like signals. This is also referred to as Rosenfell detection.
- Average-the detector determines the average of the signal within the sweep points. The averaging method depends upon the Average Type selection (voltage, power or log scales).
- Peak-the detector determines the maximum of the signal within the sweep points.
- Sample-the detector indicates the instantaneous level of the signal at the center of the sweep points represented by each display point.
- Negative Peak-the detector determines the minimum of the signal within the sweep points.

Key Path	Detector
Initial S/W Revision	Prior to A.02.00

Detector Selection

Selects a detector to be used by the analyzer for the current measurement.

Key Path	Trace/Detector
Mode	SA, WCDMA, C2K, WIMAX OFDMA, 1xEVDO, DVB-T/H, DTMB (CTTB), ISDB-T, CMMB, LTE, LTETDD, Digital Cable TV, WLAN, MSR
Remote Command	[:SENSE]:CHPower:DETECTOR[:FUNCTION] NORMal AVERAge POSitive SAMPlE NEGative [:SENSE]:CHPower:DETECTOR[:FUNCTION]?
Example	CHP:DET NORM CHP:DET?
Notes	<p>When you manually select a detector (instead of selecting Auto), that detector is used regardless of other analyzer settings.</p> <p>The Normal detector determines the peak of CW-like signals, and it yields alternating maximums and minimums of noise-like signals. This method of detection is also referred to as Rosenfell detection.</p> <p>The Average detector determines the average of the signal within the sweep points. The averaging method is Power Average (RMS).</p> <p>The Peak detector determines the maximum of the signal within the sweep points.</p> <p>The Sample detector indicates the instantaneous level of the signal at the center of the sweep points represented by each display point.</p> <p>The Negative Peak detector determines the minimum of the signal within the sweep points.</p>

Channel Power Measurement
Trace/Detector

Couplings	When Detector setting is “Auto” ([:SENSe]:CHPower:DETECTOR:AUTO?), Detector ([:SENSe]:CHPower:DETECTOR[:FUNCTION]?) switches aligning with the switch of this parameter: “NORMAl” with Clear Write, “AVERAge” with AVERAge, “POSitive (peak)” with MAXHold, and “NEGative (peak)” with MINHold.
Preset	AVERAge
State Saved	Saved in instrument state.
Range	Normal Average Peak Sample Negative Peak
Initial S/W Revision	Prior to A.02.00
Modified at S/W Revision	A.02.00, A.03.00

Auto

Sets the detector for the currently selected trace to Auto.

Key Path	Trace/Detector
Mode	SA, WCDMA, C2K, WIMAX OFDMA, 1xEVDO, DVB-T/H, DTMB (CTTB), ISDB-T, CMMB, LTE, LTETDD, Digital Cable TV, WLAN, MSR
Remote Command	[:SENSe] :CHPower :DETECTOR :AUTO ON OFF 1 0 [:SENSe] :CHPower :DETECTOR :AUTO?
Example	CHP:DET:AUTO ON CHP:DET:AUTO?
Couplings	When Detector setting is “Auto” ([:SENSe]:CHPower:DETECTOR:AUTO?), Detector ([:SENSe]:CHPower:DETECTOR[:FUNCTION]?) switches aligning with the switch of this parameter: “NORMAl” with Clear Write, “AVERAge” with AVERAge, “POSitive (peak)” with MAXHold, and “NEGative (peak)” with MINHold.
Preset	Others: ON DVB-T/H, DTMB (CTTB), ISDB-T, CMMB, Digital Cable TV: OFF
State Saved	Saved in instrument state.
Initial S/W Revision	Prior to A.02.00
Modified at S/W Revision	A.02.00, A.03.00

Trigger

Accesses a menu of functions that enable you to select and control the trigger source for the current measurement.

See [“Trigger” on page 1595](#) for more information.

Key Path	Front-panel key
Initial S/W Revision	Prior to A.02.00

View/Display

Accesses a menu of functions that enable you to control the instrument display as well as turn the bar graph On and Off.

If current mode is NOT DVB-T/H, DTMB (CTTB), ISDB-T, MSR or CMMB mode, the front panel views only contain one view: Spectrum View. The results of the measurement can be displayed as a single spectrum trace view or displayed with a Bar Graph trace on the spectrum trace.

Spectrum View with Bar Graph off

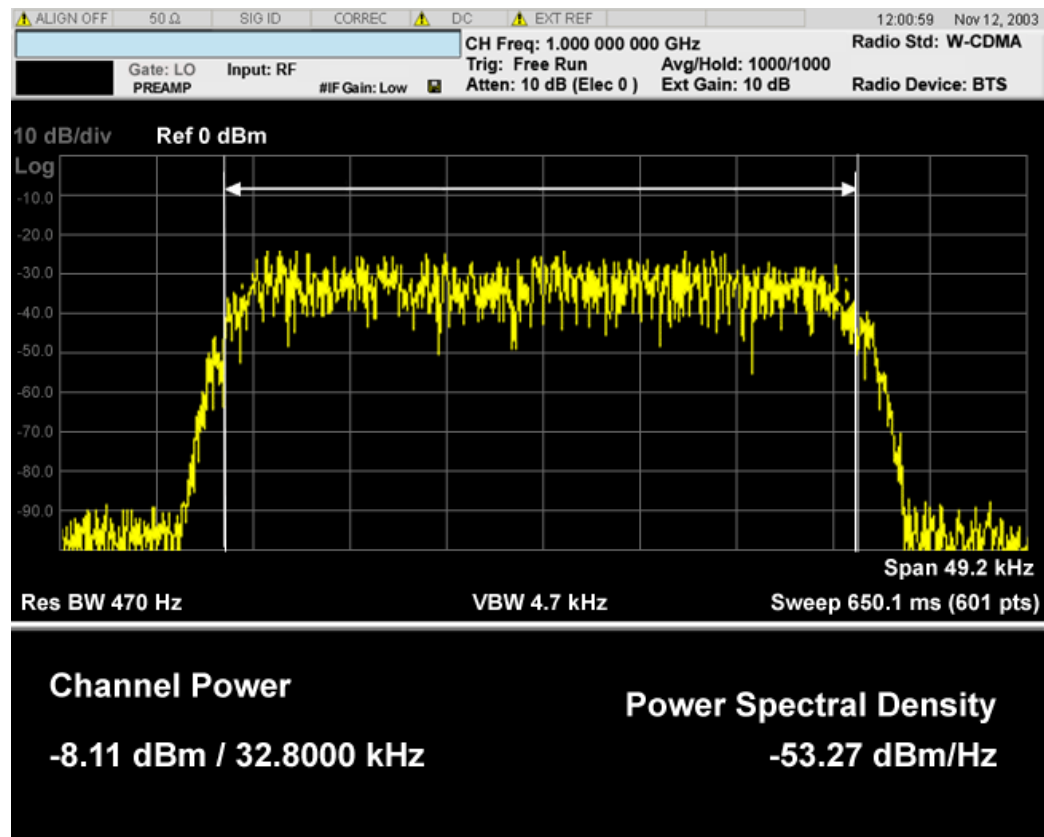

Spectrum View with Bar Graph on

This View is the same as the ‘Spectrum’ view, but has a blue bar between the markers that indicates the measured output power level. The bar graph is activated when the “Bar Graph” Soft Key is set to ON under the View/Display menu. The actual measured output power level is displayed on the display at the bottom of the bar.

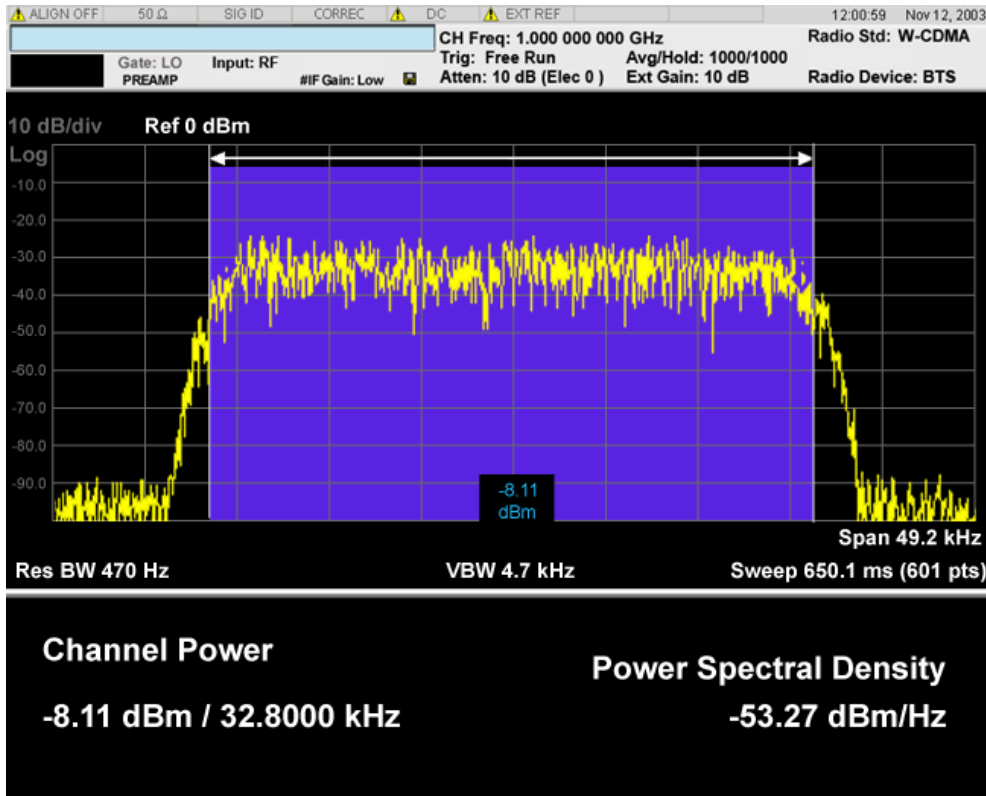

If current mode is MSR, there are two views, Power Results and Carrier Info. Power Results view is almost the same as the common CHP view.

Power Results:

The spectrum trace and power bars are displayed in the upper window. Total carrier power, total PSD and total format carrier power are displayed in the lower window. Total format carrier power is total power of carriers of the same Radio Format. If there is no carrier of the corresponding format, it is not displayed. Thus items in the total format power table changes depending on the carrier configuration. Since the metrics window of MSR is a bit denser than the common CHP, vertical positions of total power and power spectral density goes up a little bit.

Carrier Info:

The lower window of Power Results view is replaced by the carrier info table in this view. Carrier center frequency can be displayed in either offset or absolute frequency depending on Carrier Freq. The table can be scrolled by Carrier Result on Meas Setup menu or by Select Carrier on Config Carriers menu. The highlighted row changes as either Carrier Result or Select Carrier is changed. The highlighted row and these keys are not coupled.

View selection by name (MSR only)

Selects the results view. The following SCPI command allows you to select the desired

measurement view by enumeration.

Key Path	No equivalent front-panel key
Mode	MSR
Remote Command	:DISPlay:CHPower:VIEW[:SElect] PRESult CINformation :DISPlay:CHPower:VIEW[:SElect]?
Example	:DISP:CHP:VIEW PRES :DISP:CHP:VIEW?
Preset	PRESult
State Saved	Saved in instrument state
Range	Power Results Carrier Info
Initial S/W Revision	A.10.00

Selects the results view. The following SCPI command allows you to select the desired measurement view by enumeration.

Key Path	No equivalent front-panel key
Mode	MSR
Remote Command	:DISPlay:CHPower:VIEW:NSElect <integer> :DISPlay:CHPower:VIEW:NSElect?
Example	DISP:CHP:VIEW:NSEL 1 DISP:CHP:VIEW:NSEL?
Preset	1
State Saved	Saved in instrument state
Min	1
Max	2
Initial S/W Revision	A.10.00

View selection by name (DTMB (CTTB), DVB-T/H only)

Selects the results view. The following SCPI command allows you to select the desired measurement view by enumeration.

Key Path	No equivalent front-panel key
Mode	DVB-T/H, DTMB (CTTB)
Remote Command	:DISPlay:CHPower:VIEW[:SElect] RFSpectrum SHOUlder MASK :DISPlay:CHPower:VIEW[:SElect]?

Example	DISP:CHP:VIEW RFSP DISP:CHP:VIEW?
Preset	RFSPpectrum
State Saved	Saved in instrument state.
Range	RF Spectrum Shoulder Attenuation Spectrum Mask
Initial S/W Revision	A.02.00

View selection by name (ISDB-T, CMMB only)

Selects the results view. The following SCPI command allows you to select the desired measurement view by enumeration.

Key Path	No equivalent front-panel key
Mode	ISDB-T, CMMB
Remote Command	:DISPlay:CHPower:VIEW[:SElect] RFSPpectrum SHOUlder :DISPlay:CHPower:VIEW[:SElect]?
Example	DISP:CHP:VIEW RFSP DISP:CHP:VIEW?
Preset	RFSPpectrum
State Saved	Saved in instrument state.
Range	RF Spectrum Shoulder Attenuation
Initial S/W Revision	A.03.00

Key Path	Front-panel key
Initial S/W Revision	Prior to A.02.00

Display

Accesses a menu of functions that enable you to set the display parameters.

See [“Display” on page 1646](#) for more information.

Key Path	View/Display
Initial S/W Revision	Prior to A.02.00

Power Results (Only for MSR)

This view consists of the following two windows:

[“Traces Window” on page 384](#)

Channel Power Measurement
View/Display

“Results Window” on page 384

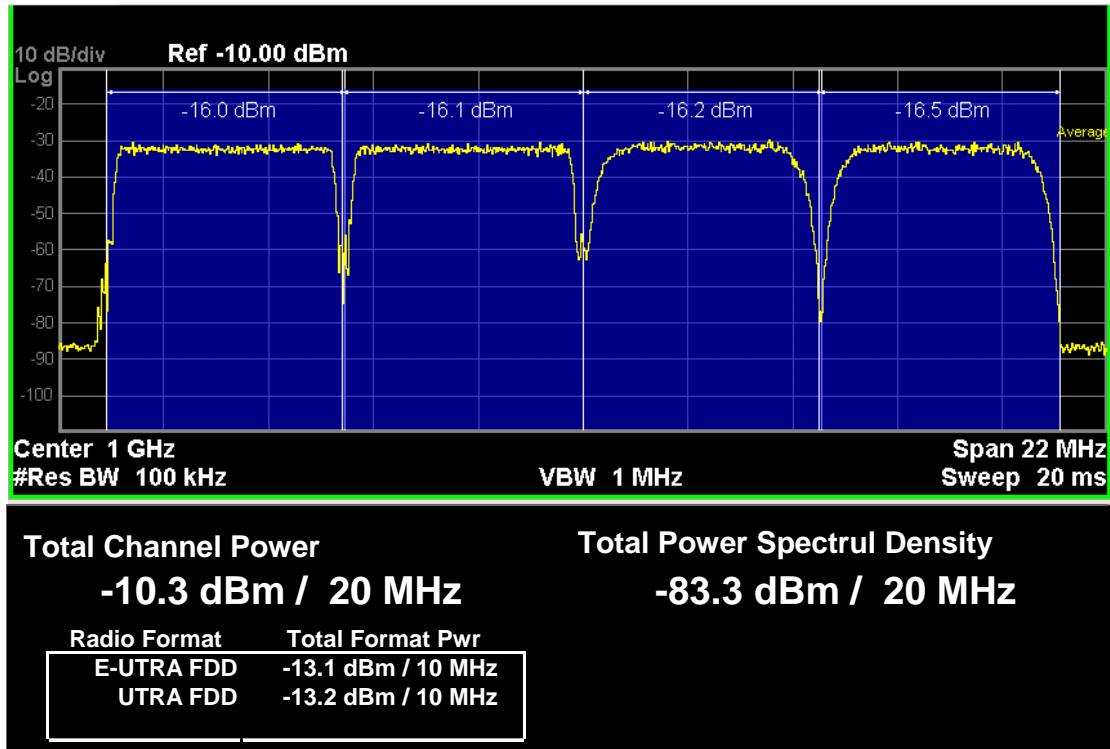

Traces Window

Corresponding Trace	yellow - spectrum trace;
---------------------	--------------------------

Results Window

Name	Corresponding Results
Total Channel Power	n=1, 1 st element Total channel power in the specified integration bandwidth
Total Power Spectral Density	n=1, 2 nd element The power in the specified unit bandwidth
Total Format Pwr	n=4 Total powers of corresponding radio format

Key Path	View/Display
Initial S/W Revision	A.10.00

Carrier Info (Only for MSR)

This view consists of the following two windows:

“Traces Window” on page 385

“Results Window” on page 385

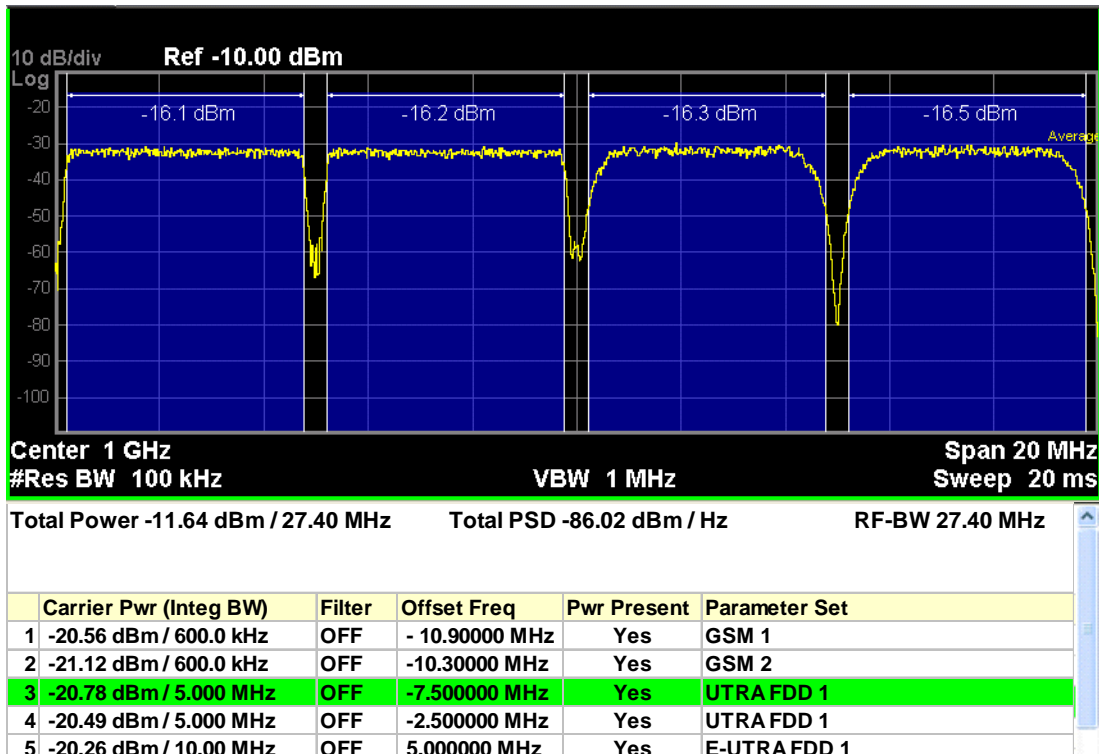

Traces Window

Corresponding Trace	yellow - spectrum trace;
---------------------	--------------------------

Results Window

Name	Corresponding Results
Total Channel Power	n=1, 1 st element Total channel power in the specified integration bandwidth
Total PSD	n=1, 2 nd element The power in the specified unit bandwidth

Channel Power Measurement
View/Display

Key Path	View/Display
Initial S/W Revision	A.10.00

Carrier Freq (Only for MSR)

Sets the carrier frequency display type.

Offset - The carrier center frequencies are displayed as offset from Carrier Ref Freq.

Absolute - The carrier center frequencies are displayed as absolute frequency.

Key Path	View/Display, Carrier Info
Mode	MSR
Remote Command	:DISPlay:CHPower:VIEW:WINDow:CINFormation:FREQuency OFFSet ABSolute :DISPlay:CHPower:VIEW:WINDow:CINFormation:FREQuency?
Example	DISP:CHP:VIEW:WIND:CINF:FREQ ABS DISP:CHP:VIEW:WIND:CINF:FREQ?
Preset	OFFSet
State Saved	Saved in instrument state
Range	Offset Absolute
Initial S/W Revision	A.10.00

Bar Graph

Turns the Bar Graph On and Off.

Key Path	DVB-T/H, DTMB (CTTB), ISDB-T, CMMB: View/Display, RF Spectrum Others: View/Display
Mode	SA, WCDMA, C2K, WIMAX OFDMA, 1xEVDO, DVB-T/H, DTMB (CTTB), ISDB-T, CMMB, LTE, LTETDD, Digital Cable TV, WLAN, MSR
Remote Command	:DISPlay:CHPower:VIEW[1]:WINDow[1]:BGRaph ON OFF 1 0 :DISPlay:CHPower:VIEW[1]:WINDow[1]:BGRaph?
Example	DISP:CHP:VIEW:WIND:BGR ON DISP:CHP:VIEW:WIND:BGR?
Notes	You must be in the Spectrum Analysis mode, W-CDMA mode, cdma2000 mode, DVB-T/H mode, DTMB (CTTB) mode, ISDB-T mode, CMMB mode, Digital Cable TV mode, LTE mode, LTE TDD mode, WLAN mode, 1xEVDO mode, MSR or WIMAX OFDMA mode to use this command. Use :INSTrument:SElect to set the mode.

Preset	OFF
State Saved	Saved in instrument state.
Range	On Off
Initial S/W Revision	Prior to A.02.00
Modified at S/W Revision	A.02.00, A.03.00

RF Spectrum (Only for DVB-T/H, DTMB (CTTB), ISDB-T and CMMB)

NOTE This view is the same as the Spectrum View above.

Selects the RF Spectrum view. This view consists of the following two windows:

[“Traces Window” on page 388](#)

[“Results Window” on page 388](#)

The measurement results are shown in a graph window and in a text window. The text window shows the absolute power and its mean power spectral density values over the specified bandwidth. This view also supports bar graph functionality. The bar graph is activated when the “Bar Graph” Soft Key is set to ON under the RF Spectrum menu. The actual measured output power level is displayed on the display at the bottom of the bar.

Channel Power Measurement
View/Display

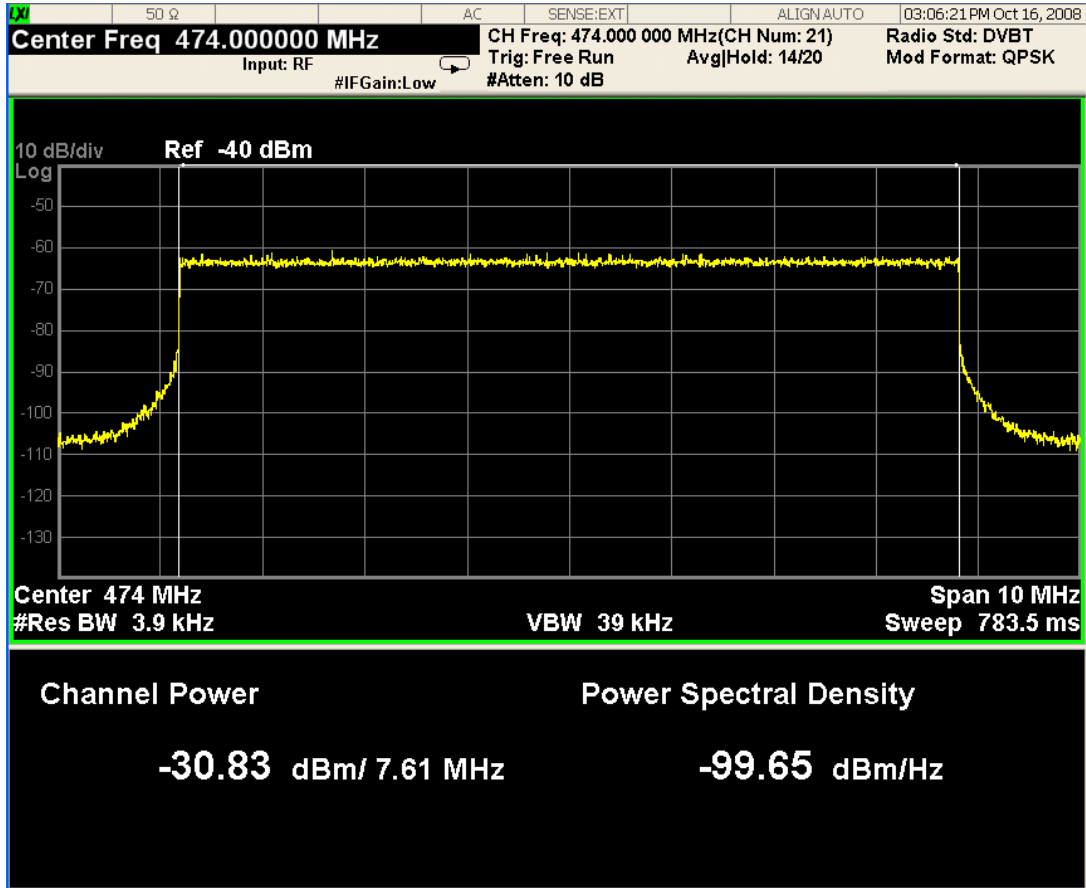

Traces Window

Corresponding Trace	yellow - spectrum trace;
---------------------	--------------------------

Results Window

Name	Corresponding Results
Channel Power	n=1, 1 st element Total channel power in the specified integration bandwidth
	Channel Integration Bandwidth
Power Spectral Density	n=1, 2 nd element The power in the specified unit bandwidth

Key Path	View/Display
Example	DISP:CHP:VIEW RFSP DISP:CHP:VIEW?
Initial S/W Revision	A.02.00

Shoulder Attenuation (Only for DVB-T/H, DTMB (CTTB), ISDB-T and CMMB)

Selects the Shoulder Attenuation view. This view is only available in DVB-T/H, DTMB (CTTB), ISDB-T and CMMB mode:

[“Shoulder Attenuation view for DVB-T/H and ISDB-T mode” on page 390](#)

[“Shoulder Attenuation view for DTMB \(CTTB\) and CMMB mode” on page 391](#)

This view consists of the following three windows:

[“Lower Shoulder Trace Window” on page 392](#)

[“Upper Shoulder Trace Window” on page 392](#)

[“Results Window” on page 392](#)

Shoulder Attenuation view for DVB-T/H and ISDB-T mode

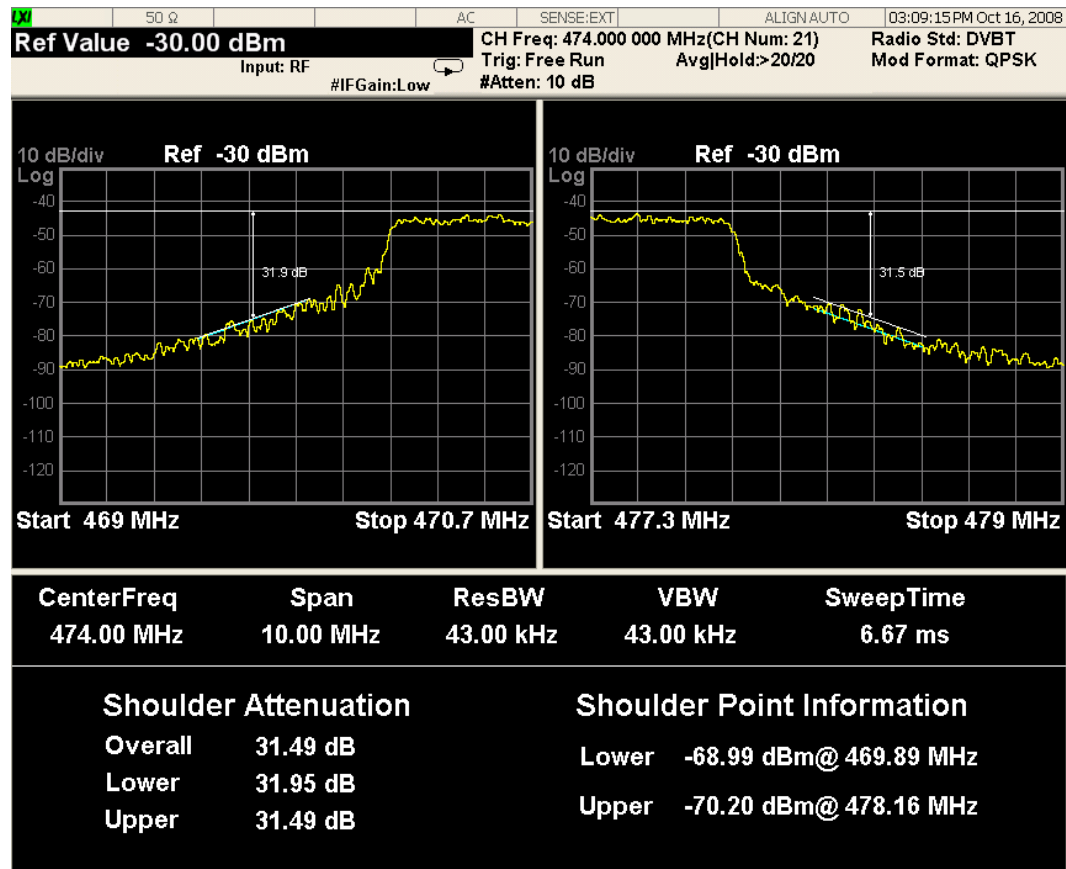

Shoulder Attenuation view for DTMB (CTTB) and CMMB mode

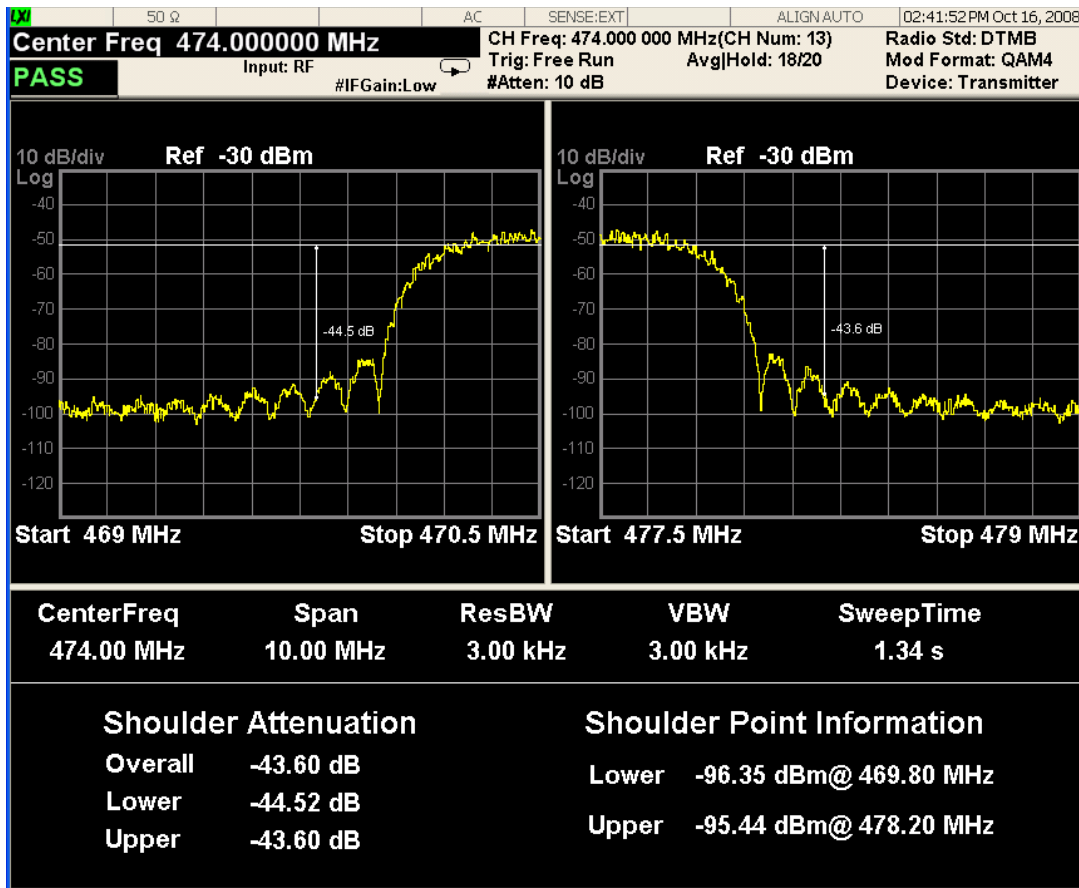

NOTE

The pass/fail function is valid only in DTMB (CTTB) and CMMB mode:

In DTMB (CTTB) mode, when the device type (under mode setup panel) is Transmitter, the pass/fail limit is -36 dBc, and for the other type – Exciter, the pass/fail limit is -48 dBc.

In CMMB mode, when the device type (under mode setup panel) is Transmitter, the pass/fail limit is -35dBc, and for the other type – Exciter, the pass/fail limit is -50dBc.

Lower Shoulder Trace Window

Corresponding Trace *	<p>yellow - lower edge of the spectrum trace;</p> <p>white - assistant lines to indicate the lower shoulder attenuation;</p> <p>(Only for DVB-T/H) cyan – assistant beeline from shoulder range begin point to the range end point;</p>
-----------------------	--

Upper Shoulder Trace Window

Corresponding Trace *	<p>yellow - upper edge of the spectrum trace;</p> <p>white - assistant lines to indicate the upper shoulder attenuation;</p> <p>(Only for DVB-T/H) cyan – assistant beeline from shoulder range begin point to the range end point;</p>
-----------------------	--

Results Window

Name	Corresponding Results
CenterFreq (MHz)	The center frequency of the measurement
Span (MHz)	The span of the measurement
ResBW (kHz)	The resolution bandwidth of the measurement
VBW (kHz)	The video bandwidth of the measurement
SweepTime (ms)	The sweep time of the measurement
Overall Shoulder Attenuation (dB)	n=3, 1 st element Shoulder attenuation result
Lower Shoulder Attenuation (dB)	n=3, 2 nd element Lower shoulder attenuation result
Upper Shoulder Attenuation (dB)	n=3, 3 rd element Upper shoulder attenuation result
Lower Shoulder Point Power (dBm) **	n=3, 4 th element The power value of the point with maximum power level in the lower edge of the spectrum
Lower Shoulder Point Frequency (MHz) **	n=3, 5 th element The frequency of the point with maximum power level in the lower edge of the spectrum
Upper Shoulder Point Power (dBm) **	n=3, 6 th element The power value of the point with maximum power level in the upper edge of the spectrum

Name	Corresponding Results
Upper Shoulder Point Frequency (MHz) **	n=3, 7 th element The frequency of the point with maximum power level in the upper edge of the spectrum

*: For DVB-T/H mode: All three traces are valid. The cyan line is connecting the measurement points 300kHz and 700kHz from each of the upper and lower edges of the spectrum (yellow trace).

For DTMB (CTTB), ISDB-T, and CMMB mode: There are only two traces: yellow trace and white trace.

** : For DVB-T/H mode: Shoulder Point Information shows the information of the maximum power level point between the points at 300 kHz and 700 kHz from each of the upper and lower edges of the spectrum trace. It contains two parts: the frequency and the power level.

For DTMB (CTTB) mode: Shoulder Point Information shows the power level of the fixed point, which is ± 4.2 MHz away from center frequency for 8MHz radio bandwidth and ± 3.2 MHz away from center frequency for 6MHz radio bandwidth.

For ISDB-T mode: Shoulder Point Information shows the information of the maximum power level point between the frequency range of -3.3 MHz to -3.5 MHz away from center frequency of the lower channel and of $+3.3$ MHz to $+3.5$ MHz away from the center frequency of the upper channel. It contains two parts: the frequency and the power level.

For CMMB mode: Shoulder Point Information shows the power level of the fixed point, which is ± 4.2 MHz away from center frequency for 8MHz radio bandwidth. It contains the frequency and the power level of the point.

Key Path	View/Display
Example	DISP:CHP:VIEW SHOU DISP:CHP:VIEW?
Initial S/W Revision	A.02.00

Spectrum Mask(DTMB (CTTB), DVB-T/H only)

Selects the Spectrum Mask view. This view consists of the following two windows:

[“Trace Window” on page 395](#)

[“Results Window” on page 395](#)

Channel Power Measurement
View/Display

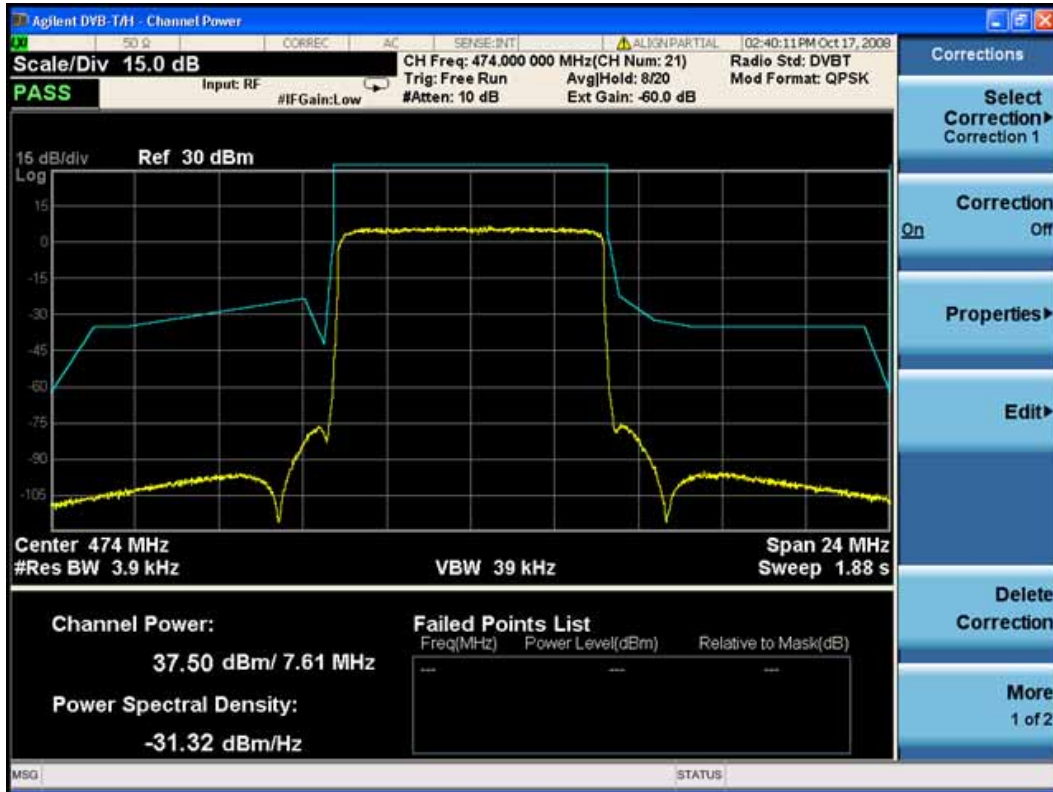

NOTE

If the current radio bandwidth is not 8 MHz, the limit line (Mask) is not available and the failed points list shows “---”. The STATUS message “No Result; No mask for X MHz” appears. (X may be 5, 6 and 7 for DVB-T/H mode and 6 for DTMB (CTTB) mode.)

Trace Window

Corresponding Trace	yellow - spectrum trace; cyan - limit line trace;
---------------------	--

Results Window

Name	Corresponding Results
Channel Power	n=1, 1 st element Total channel power in the specified integration bandwidth
	Channel Integration Bandwidth
Power Spectral Density	n=1, 2 nd element The power in the specified unit bandwidth
Failed Points List *	n=7 The failed point's information: frequency, absolute power and relative power

*: If the number of the failed points is less than twenty, all of them (frequency, power and relative power) will be shown in the failed points list; and if the number of the failed points is more than twenty, only the first ten and the last ten failed points will be shown.

Key Path	View/Display
Example	DISP:CHP:VIEW MASK DISP:CHP:VIEW?
Initial S/W Revision	A.02.00

Mask - selection by Enum (Only for DVB-T/H mode)

Selects the mask line in the spectrum mask view. The following SCPI command allows you to select the desired mask by enumeration. It includes six kinds of limit line: L/SECAM/NICAM, G/PAL/NICAM, I/PAL/NICAM, G/PAL/A2, K/SECAM and K/PAL.

Key Path	View/Display, Spectrum Mask
Mode	DVB-T/H
Remote Command	:DISPlay:CHPower:VIEW:MASK[:SElect] LSNI GPNI IPNI GPA2 KSKP :DISPlay:CHPower:VIEW:MASK[:SElect]?
Example	DISP:CHP:VIEW:MASK LSNI DISP:CHP:VIEW:MASK?

Channel Power Measurement
View/Display

Dependencies	If current Radio BW is not 8 MHz, the STATUS message “No result” will be displayed. But the keys under the Spectrum Mask are still displayed.
Preset	LSNI
State Saved	Saved in instrument state.
Range	LSecam_Nicam GPal_Nicam IPal_Nicam GPal_A2 KSecam_KPal
Initial S/W Revision	A.02.00

Limit Mask (DTMB (CTTB), DVB-T/H only)

Turns the Mask Line On and Off.

Key Path	View/Display, Spectrum Mask
Mode	DVB-T/H, DTMB (CTTB)
Remote Command	:CALCulate:CHPower:MASK:STATe ON OFF 1 0 :CALCulate:CHPower:MASK:STATe?
Example	:CALC:CHP:MASK:STAT ON :CALC:CHP:MASK:STATe?
Notes	You must be in DVB-T/H mode and DTMB (CTTB) mode to use this command. Use :INSTrument:SElect to set the mode.
Preset	On
State Saved	Saved in instrument state.
Range	On Off
Initial S/W Revision	A.06.00

Scroll

Accesses the Scroll menu, which contains features that enable you to navigate the display.

Key Path	View/Display, Spectrum Mask
Mode	DVB-T/H, DTMB (CTTB)
Initial S/W Revision	A.02.00

Prev Page

Moves the display one page back to the previous page of the result metrics window in Spectrum Mask view.

Key Path	View/Display, Spectrum Mask, Scroll
Mode	DVB-T/H, DTMB (CTTB)

Initial S/W Revision	A.02.00
----------------------	---------

Next Page

Moves the display one page forward to the next page of the result metrics window in Spectrum Mask view.

Key Path	View/Display, Spectrum Mask, Scroll
Mode	DVB-T/H, DTMB (CTTB)
Initial S/W Revision	A.02.00

Scroll Up

Moves one line upward from the current line of the result metrics window in Spectrum Mask view.

Pressing the up arrow hard key has the same effect as this function, if no active function is shown. If an active function is shown, the up arrow hard key controls the active function, but has no effect on line movement.

Key Path	View/Display, Spectrum Mask, Scroll
Mode	DVB-T/H, DTMB (CTTB)
Initial S/W Revision	A.02.00

Scroll Down

Moves one line downward from the current line of the result metrics window in Spectrum Mask view.

Pressing the down arrow hard key has the same effect as this function, if no active function is shown. If an active function is shown, the up arrow hard key controls the active function, but has no effect on line movement, as the Scroll Down function does.

Key Path	View/Display, Spectrum Mask, Scroll
Mode	DVB-T/H, DTMB (CTTB)
Initial S/W Revision	A.02.00

First Page

Moves the display to the first page of the result metrics window in Spectrum Mask view.

Key Path	View/Display, Spectrum Mask, Scroll
Mode	DVB-T/H, DTMB (CTTB)
Initial S/W Revision	A.02.00

Last Page

Moves the display to the last page of the result metrics window in Spectrum Mask view.

Key Path	View/Display, Spectrum Mask, Scroll
Mode	DVB-T/H, DTMB (CTTB)
Initial S/W Revision	A.02.00

The Occupied Bandwidth measurement computes and displays the bandwidth occupied by a given percentage of the total mean power of a signal. For measurement results and views, see [“View/Display” on page 451](#).

For information on how to make measurement using the X-Series Signal Analyzer, see:

Measurement Guide [n9080-90006.pdf].

This topic contains the following sections:

[“Remote Commands for Occupied Bandwidth ” on page 399](#)

[“Remote Command Results for Occupied Bandwidth Measurement” on page 400](#)

Remote Commands for Occupied Bandwidth

```
:CONFigure:OBWidth  
:CONFigure:OBWidth:NDEFault  
:INITiate:OBWidth  
:FETCh:OBWidth [n]?  
:MEASure:OBWidth [n]?  
:READ:OBWidth [n]?  
:FETCh:OBWidth:OBWidth?  
:MEASure:OBWidth:OBWidth?  
:READ:OBWidth:OBWidth?  
:FETCh:OBWidth:FERRor?  
:MEASure:OBWidth:FERRor?  
:READ:OBWidth:FERRor?  
:FETCh:OBWidth:XDB?  
:MEASure:OBWidth:XDB?  
:READ:OBWidth:XDB?
```

See also the section, [“Remote Measurement Functions” on page 1520](#).

Remote Command Results for Occupied Bandwidth Measurement

n	Results Returned
n=1 (or not specified)	Returns 6 scalar results, in the following order: 1. Occupied bandwidth – Hz 2. Total Power – dBm (Total Power will be obsolete in TD-SCDMA mode, this place will be replaced by NaN) 3. Span - Hz 4. Spectrum Trace Points - points 5. Res BW – Hz 6. Transmit Frequency Error Hz 7. x DB Bandwidth - Hz
2	Returns the frequency-domain spectrum trace (data array) for the entire frequency range being measured.
Mode = MSR n = 3	1. Number of active carriers

Key Path	Meas
Initial S/W Revision	Prior to A.02.00

AMPTD Y Scale (Amplitude/Y Scale)

Activates the Reference Value function and displays the Amplitude menu keys. These functions control how data on the vertical (Y) axis is displayed and control instrument settings that affect the vertical axis

See “AMPTD Y Scale” on page 1379 for more information.

Key Path	Front-panel key
Initial S/W Revision	Prior to A.02.00

Ref Value

Sets the absolute power reference value. However, since the Auto Scaling is defaulted to On, this value is automatically determined by the measurement result. When you set a value manually, Auto Scaling automatically changes to Off.

Key Path	AMPTD Y Scale
Mode	SA, WCDMA, C2K, WIMAX OFDMA, TD-SCDMA, 1xEVDO, ISDB-T, CMMB, LTE, LTETDD, BLUETOOTH, WLAN, MSR
Remote Command	:DISPlay:OBWidth:VIEW[1]:WINDow[1]:TRACe:Y[:SCALe]:RLEV el <real> :DISPlay:OBWidth:VIEW[1]:WINDow[1]:TRACe:Y[:SCALe]:RLEV el?
Example	DISP:OBW:VIEW:WIND:TRAC:Y:RLEV 125 DISP:OBW:VIEW:WIND:TRAC:Y:RLEV?
Notes	You must be in the Spectrum Analysis mode, W-CDMA mode, cdma2000 mode, TD-SCDMA mode, ISDB-T mode, CMMB mode, BLUETOOTH mode, LTE mode, LTE TDD mode, WLAN mode, 1xEVDO mode, MSR or WIMAX OFDMA mode to use this command. Use:INSTrument:SElect to set the mode.
Couplings	When the Auto Scaling is On, this value is automatically determined by the measurement result. When you set a value manually, Auto Scaling automatically changes to Off.
Preset	10.00 dBm
State Saved	Saved in instrument state.
Min	-250.00 dBm
Max	250.00 dBm
Initial S/W Revision	Prior to A.02.00
Modified at S/W Revision	A.03.00

Attenuation

Accesses a menu of functions that enable you to change the attenuation settings. This key has read-back text that describes the total attenuator value.

See “Attenuation” on page 1381 for more information.

Key Path	AMPTD Y Scale
Initial S/W Revision	Prior to A.02.00

Scale/Div

Sets the logarithmic units per vertical graticule division on the display. When the Auto Scaling is On, the Scale/Div is automatically determined by the measurement result. When you set a value manually, Auto Scaling is automatically toggled to Off.

Key Path	AMPTD Y Scale
Mode	SA, WCDMA, C2K, WIMAX OFDMA, TD-SCDMA, 1xEVDO, ISDB-T, CMMB, LTE, LTETDD, BLUETOOTH, WLAN, MSR
Remote Command	:DISPlay:OBWidth:VIEW[1]:WINDow[1]:TRACe:Y[:SCALE]:PDIV ision <rel_ampl> :DISPlay:OBWidth:VIEW[1]:WINDow[1]:TRACe:Y[:SCALE]:PDIV ision?
Example	DISP:OBW:VIEW:WIND:TRAC:Y:PDIV 5 DISP:OBW:VIEW:WIND:TRAC:Y:PDIV?
Notes	You must be in the Spectrum Analysis mode, W-CDMA mode, cdma2000 mode, TD-SCDMA mode, ISDB-T mode, CMMB mode, LTE mode, LTE TDD mode, BLUETOOTH mode, WLAN mode, 1xEVDO mode, MSR or WIMAX OFDMA mode to use this command. Use:INSTrument:SElect to set the mode.
Couplings	When the Auto Scaling is On, this value is automatically determined by the measurement result. When you set a value manually, Auto Scaling automatically changes to Off.
Preset	10.00 dB
State Saved	Saved in instrument state.
Min	0.10 dB
Max	20.00 dB
Initial S/W Revision	Prior to A.02.00
Modified at S/W Revision	A.03.00

Presel Center

When this key is pressed, the centering of the preselector filter is adjusted to optimize the amplitude accuracy at the frequency of the selected marker.

See [“Presel Center” on page 1396](#) for more information.

Key Path	AMPTD/Y Scale
Initial S/W Revision	Prior to A.02.00

Presel Adjust

Allows you to manually adjust the preselector filter frequency to optimize its response to the signal of interest. This function is only available when Presel Center is available.

See [“Preselector Adjust” on page 1398](#) for more information.

Key Path	AMPTD/Y Scale
Initial S/W Revision	Prior to A.02.00

Y Axis Unit

Allows you to change the vertical (Y) axis amplitude unit.

See [“Y Axis Unit” on page 1399](#) under AMPTD Y Scale in the "Common Measurement Functions" section for more information.

Key Path	AMPTD/Y Scale
Initial S/W Revision	A.04.00

Reference Level Offset

Adds an offset value to the displayed reference level. The reference level is the absolute amplitude represented by the top graticule line on the display.

See [“Reference Level Offset” on page 1404](#) under AMPTD Y Scale in the "Common Measurement Functions" section for more information.

Key Path	AMPTD/Y Scale
Initial S/W Revision	A.04.00

μW Path Control

The **μW Path Control** functions include the **μW Preselector Bypass** (Option MPB) and **Low Noise Path** (Option LNP) controls in the High Band path circuits.

See [“μW Path Control” on page 1405](#) under AMPTD Y Scale in the "Common Measurement Functions"

Occupied Bandwidth Measurement
AMPTD Y Scale (Amplitude/Y Scale)

section for more information.

Key Path	AMPTD/Y Scale
Initial S/W Revision	A.04.00

Internal Preamp

Accesses a menu of functions that enable you to control the internal preamplifiers.

See “[Internal Preamp](#)” on page 1410 for more information.

Key Path	AMPTD Y Scale
Initial S/W Revision	Prior to A.02.00

Ref Position

Positions the reference level at the top, center or bottom of the Y Scale display. Changing the reference position does not change the reference level value.

Key Path	AMPTD Y Scale
Mode	SA, WCDMA, C2K, WIMAX OFDMA, TD-SCDMA, 1xEVDO, ISDB-T, CMMB, LTE, LTETDD, BLUETOOTH, WLAN, MSR
Remote Command	:DISPlay:OBWidth:VIEW[1]:WINDow[1]:TRACe:Y[:SCALE]:RPOS ition TOP CENTer BOTTom :DISPlay:OBWidth:VIEW[1]:WINDow[1]:TRACe:Y[:SCALE]:RPOS ition?
Example	DISP:OBW:VIEW:WIND:TRAC:Y:RPOS BOTT DISP:OBW:VIEW:WIND:TRAC:Y:RPOS?
Notes	You must be in the Spectrum Analysis mode, W-CDMA mode, cdma2000 mode, TD-SCDMA mode, ISDB-T mode, CMMB mode, LTE mode, LTE TDD mode, BLUETOOTH mode, WLAN mode, 1xEVDO mode, MSR or WIMAX OFDMA mode to use this command. Use:INSTrument:SELEct to set the mode.
Preset	TOP
State Saved	Saved in instrument state.
Range	Top Ctr Bot
Initial S/W Revision	Prior to A.02.00
Modified at S/W Revision	A.03.00

Auto Scaling

Allows you to toggle the Auto Scaling function between On and Off.

Key Path	AMPTD Y Scale
Mode	SA, WCDMA, C2K, WIMAX OFDMA, TD-SCDMA, 1xEVDO, ISDB-T, CMMB, LTE, LTETDD, BLUETOOTH, WLAN, MSR
Remote Command	:DISPlay:OBWidth:VIEW[1]:WINDow[1]:TRACe:Y[:SCALe]:COUPle 0 1 OFF ON :DISPlay:OBWidth:VIEW[1]:WINDow[1]:TRACe:Y[:SCALe]:COUPle?
Example	DISP:OBW:VIEW:WIND:TRAC:Y:COUP ON DISP:OBW:VIEW:WIND:TRAC:Y:COUP?
Couplings	When Auto Scaling is On, upon pressing the Restart front-panel key, this function automatically sets the scale per division to 10 dB and determines reference values based on the measurement results. When you set a value to either Scale/Div or Ref Value manually, Auto Scaling automatically changes to Off.
Preset	1
State Saved	Saved in instrument state.
Range	On Off
Initial S/W Revision	Prior to A.02.00
Modified at S/W Revision	A.03.00

Auto Couple

The Auto Couple function is not supported in this measurement.

Key Path	Front-panel key
Initial S/W Revision	Prior to A.02.00

BW

Accesses a menu of functions that enable you to specify and control the video and resolution bandwidths. You can also select the type of filter for the measurement.

Key Path	Front-panel key
Initial S/W Revision	Prior to A.02.00

Res BW

Sets the resolution bandwidth for the current measurement. If an unavailable bandwidth is entered with the numeric keypad, the closest available bandwidth is selected.

Key Path	BW
Mode	SA, WCDMA, C2K, WIMAX OFDMA, TD-SCDMA, 1xEVDO, ISDB-T, CMMB, LTE, LTETDD, BLUETOOTH, WLAN, MSR
Remote Command	[:SENSE]:OBwidth:BANDwidth[:RESolution] <bandwidth> [:SENSE]:OBwidth:BANDwidth[:RESolution]? [:SENSE]:OBwidth:BANDwidth[:RESolution]:AUTO ON OFF 1 0 [:SENSE]:OBwidth:BANDwidth[:RESolution]:AUTO?
Example	OBW:BAND 250000 OBW:BAND? OBW:BAND:AUTO OFF OBW:BAND:AUTO?
Notes	You must be in the Spectrum Analysis mode, W-CDMA mode, cdma2000 mode, TD-SCDMA mode, ISDB-T mode, CMMB mode, LTE mode, LTE TDD mode, BLUETOOTH mode, WLAN mode, 1xEVDO mode, MSR or WIMAX OFDMA mode to use this command. Use:INSTRUMENT:SElect to set the mode.
Couplings	Sweep time is coupled to RBW. As the RBW changes, the sweep time (if set to Auto) is changed to maintain amplitude calibration. Video bandwidth (VBW) is coupled to RBW. As the resolution bandwidth changes, the video bandwidth (if set to Auto) changes to maintain the ratio of VBW/RBW (10:1). When Res BW is set to Auto, the resolution bandwidth is auto-coupled to span. The ratio of Span/RBW is approximately 106:1 when auto coupled. When Res BW is set to Man, bandwidths are entered manually, and these bandwidths are used regardless of other analyzer settings.

Occupied Bandwidth Measurement
BW

Preset	SA: Auto WCDMA: 30 kHz CDMA2K: 12 kHz WIMAX OFDMA: 100 kHz TD-SCDMA: 30 kHz 1xEVDO: 30 kHz ISDB-T: 10 kHz CMMB: 3 kHz LTE: 30 kHz LTETDD: 30 kHz BLUETOOTH: 10 kHz WLAN: 100kHz MSR: 30 kHz SA: ON WCDMA, C2K, TD-SCDMA, WIMAX OFDMA, 1xEVDO, ISDB-T, CMMB, LTE, LTETDD, WLAN, MSR: OFF
State Saved	Saved in instrument state.
Min	1 Hz
Max	8 MHz
Backwards Compatibility SCPI	[:SENSe]:OBWidth:BWIDth[:RESolution]
Initial S/W Revision	Prior to A.02.00
Modified at S/W Revision	A.03.00

Video BW

Changes the analyzer post-detection filter.

Key Path	BW
Mode	SA, WCDMA, C2K, WIMAX OFDMA, TD-SCDMA, 1xEVDO, ISDB-T, CMMB, LTE, LTETDD, BLUETOOTH, WLAN, MSR
Remote Command	[:SENSe]:OBWidth:BAWdwidth:VIDeo <bandwidth> [:SENSe]:OBWidth:BAWdwidth:VIDeo? [:SENSe]:OBWidth:BAWdwidth:VIDeo:AUTO ON OFF 1 0 [:SENSe]:OBWidth:BAWdwidth:VIDeo:AUTO?

Example	<p>OBW:BAND:VID 5 MHz</p> <p>OBW:BAND:VID?</p> <p>OBW:BAND:VID:AUTO ON</p> <p>OBW:BAND:VID:AUTO?</p>
Notes	<p>You must be in the Spectrum Analysis mode, W-CDMA mode, cdma2000 mode, TD-SCDMA mode,ISDB-T mode, CMMB mode, LTE mode, LTE TDD mode,BLUETOOTH mode, WLAN mode, 1xEVDO mode, MSR or WIMAX OFDMA mode to use this command. Use:INSTrument:SElect to set the mode.</p>
Dependencies	<p>When using the average detector with either Sweep Time set to Man, or in zero span, the VBW setting has no effect and is disabled (grayed out).</p>
Couplings	<p>Video bandwidth (VBW) is coupled to RBW. As the resolution bandwidth changes, the video bandwidth (if set to Auto) changes to maintain the ratio set by VBW/RBW.</p> <p>Sweep Time is coupled to Video Bandwidth (VBW). As the VBW is changed, the sweep time (when set to Auto) is changed to maintain amplitude calibration. This occurs because of common hardware between the two circuits, even though the Video BW filter is not actually “in-circuit” when the detector is set to Average. Because the purpose of the average detector and the VBW filter are the same, either can be used to reduce the variance of the result.</p> <p>Although the VBW filter is not “in-circuit” when using the average detector, the Video BW key can have an effect on (Auto) sweep time, and is not disabled. In this case, reducing the VBW setting increases the sweep time, which increases the averaging time, producing a lower-variance trace.</p> <p>When the video bandwidth is AUTO coupled, the video bandwidth value is set to:</p> <p>Resolution Bandwidth * Video Bandwidth to Resolution Bandwidth Ratio</p>
Preset	<p>SA, LTE, LTETDD, WLAN, MSR: Auto</p> <p>WCDMA: 300 kHz</p> <p>CDMA2K:120 kHz</p> <p>WIMAX OFDMA: 1 MHz</p> <p>TD-SCDMA: 300 kHz</p> <p>1xEVDO: 300 kHz</p> <p>ISDB-T: 300 Hz</p> <p>CMMB: 3 kHz</p> <p>BLUETOOTH: 30 kHz</p> <p>ON</p> <p>ISDB-T, CMMB: OFF</p>
State Saved	<p>Saved in instrument state.</p>

Occupied Bandwidth Measurement
BW

Min	1 Hz
Max	50 MHz
Backwards Compatibility SCPI	[[:SENSe]:OBWidth:BWIDth:VIDeo
Initial S/W Revision	Prior to A.02.00
Modified at S/W Revision	A.03.00

Filter Type

Allows you to select the type of filter to be used for the current measurement. Besides the Gaussian filter shape, there are certain special filter types, such as Flat Top, that are desirable under certain conditions.

Key Path	BW
Mode	SA, WCDMA, C2K, WIMAX OFDMA, TD-SCDMA, 1xEVDO, ISDB-T, CMMB, LTE, LTETDD, BLUETOOTH, WLAN, MSR
Remote Command	[[:SENSe]:OBWidth:BAWdwidth:SHAPE GAUSSian FLATtop [[:SENSe]:OBWidth:BAWdwidth:SHAPE?
Example	OBW:BAND:SHAP GAUS OBW:BAND:SHAP?
Preset	GAUSSian
State Saved	Saved in instrument state.
Range	Gaussian Flattop
Backwards Compatibility SCPI	[[:SENSe]:OBWidth:BWIDth:SHAPE
Initial S/W Revision	Prior to A.02.00
Modified at S/W Revision	A.03.00

Cont (Continuous)

See “[Cont \(Continuous Measurement/Sweep\)](#)” on page 1413 for more information.

Key Path	Front-panel key
Initial S/W Revision	Prior to A.02.00

FREQ/Channel (Frequency or Channel)

See “[FREQ Channel](#)” on page 1414 for more information.

Key Path	Front-panel key
Initial S/W Revision	Prior to A.02.00

Input/Output

See “[Input/Output](#)” on page 1422 for more information.

Key Path	Front-panel key
Initial S/W Revision	Prior to A.02.00

Marker

Accesses a menu that enables you to select, set up and control the markers for the current measurement.

Key Path	Front-panel key
Initial S/W Revision	Prior to A.02.00

Select Marker

Displays the menu keys that enable you to select, set up and control the markers for the current measurement

Key Path	Marker
Initial S/W Revision	Prior to A.02.00

Marker X Axis Value (Remote Command Only)

Sets the marker X Axis value in the current marker X Axis Scale unit. It has no effect if the control mode is **Off**.

Key Path	SCPI only
Mode	SA, WCDMA, C2K, WIMAX OFDMA, TD-SCDMA, 1xEVDO, ISDB-T, CMMB, LTE, LTETDD, BLUETOOTH, WLAN, MSR
Remote Command	:CALCulate:OBwidth:MARKer[1] 2 3 4 5 6 7 8 9 10 11 12:X <freq> :CALCulate:OBwidth:MARKer[1] 2 3 4 5 6 7 8 9 10 11 12:X ?
Example	CALC:OBW:MARK3:X 0 CALC:OBW:MARK3:X?
Notes	The query returns the marker's absolute X Axis value if the control mode is Normal , or the offset from the marker's reference marker if the control mode is Delta . The query is returned in the fundamental units for the current marker X Axis scale: Hz for Frequency .
Preset	After a preset, all markers are turned OFF, so Marker X Axis Value query returns a not a number (NAN).
State Saved	No
Min	-9.9E+37
Max	9.9E+37
Initial S/W Revision	Prior to A.02.00

Modified at S/W Revision	A.03.00
--------------------------	---------

Marker X Axis Position (Remote Command Only)

Sets the marker X position in trace points. It has no effect if the control mode is **Off**.

Key Path	SCPI only
Mode	SA, WCDMA, C2K, WIMAX OFDMA, TD-SCDMA, 1xEVDO, ISDB-T, CMMB, LTE, LTETDD, BLUETOOTH, WLAN, MSR
Remote Command	:CALCulate:OBWidth:MARKer[1] 2 3 4 5 6 7 8 9 10 11 12:X :POSition <real> :CALCulate:OBWidth:MARKer[1] 2 3 4 5 6 7 8 9 10 11 12:X :POSition?
Example	CALC:OBW:MARK10:X:POS 0 CALC:OBW:MARK10:X:POS?
Notes	The query returns the marker's absolute X Axis value in trace points if the control mode is Normal , or the offset from the marker's reference marker in trace points if the control mode is Delta .
Preset	After a preset, all markers are turned OFF, so Marker X Axis Value query returns a not a number (NAN).
State Saved	No
Min	-9.9E+37
Max	9.9E+37
Initial S/W Revision	Prior to A.02.00
Modified at S/W Revision	A.03.00

Marker Y Axis Value (Remote Command Only)

Returns the marker Y Axis value in the current marker Y Axis unit.

Key Path	SCPI only
Mode	SA, WCDMA, C2K, WIMAX OFDMA, TD-SCDMA, 1xEVDO, ISDB-T, CMMB, LTE, LTETDD, BLUETOOTH, WLAN, MSR
Remote Command	:CALCulate:OBWidth:MARKer[1] 2 3 4 5 6 7 8 9 10 11 12:Y ?
Example	CALC:OBW:MARK11:Y?
Preset	Result dependent on Markers setup and signal source.
State Saved	No
Min	-9.9E+37

Occupied Bandwidth Measurement
Marker

Max	9.9E+37
Initial S/W Revision	Prior to A.02.00
Modified at S/W Revision	A.03.00

Marker Type

Sets the marker control mode to **Normal**, **Delta** or **Off**. If the selected marker is Off, pressing Marker sets it to Normal and places a single marker at the center of the display. At the same time, **Marker X Axis Value** appears on the Active Function area.

Key Path	Marker
Mode	SA, WCDMA, C2K, WIMAX OFDMA, TD-SCDMA, 1xEVDO, ISDB-T, CMMB, LTE, LTETDD, BLUETOOTH, WLAN, MSR
Remote Command	:CALCulate:OBwidth:MARKer[1] 2 3 4 5 6 7 8 9 10 11 12:MODE POSITION DELTA OFF :CALCulate:OBwidth:MARKer[1] 2 3 4 5 6 7 8 9 10 11 12:MODE?
Example	CALC:OBW:MARK:MODE POS CALC:OBW:MARK:MODE?
Notes	If the selected marker is Off, pressing Marker sets it to Normal and places it at the center of the screen on the trace determined by the Marker Trace rules. At the same time, Marker X Axis Value appears on the Active Function area. Default Active Function: the active function for the selected marker's current control mode. If the current control mode is Off, there is no active function and the active function is turned off. Active Function Display: the marker X axis value entered in the active function area displays the marker value to its full entered precision.
Preset	OFF
State Saved	Saved in instrument state.
Range	Normal Delta Off
Initial S/W Revision	Prior to A.02.00
Modified at S/W Revision	A.03.00

Properties

Accesses the marker properties menu.

Key Path	Marker
Initial S/W Revision	Prior to A.02.00

Select Marker

Displays 12 markers available for selection.

Key Path	Marker, Properties
Initial S/W Revision	Prior to A.02.00

Relative To

Selects the desired marker. The selected marker will be relative to its reference marker.

Key Path	Marker, Properties
Mode	SA, WCDMA, C2K, WIMAX OFDMA, TD-SCDMA, 1xEVDO, ISDB-T, CMMB, LTE, LTETDD, BLUETOOTH, WLAN, MSR
Remote Command	:CALCulate:OBWidth:MARKer[1] 2 3 4 5 6 7 8 9 10 11 12:REFerence <integer> :CALCulate:OBWidth:MARKer[1] 2 3 4 5 6 7 8 9 10 11 12:REFerence?
Example	CALC:OBW:MARK:REF 2 CALC:OBW:MARK:REF?
Notes	A marker cannot be relative to itself so that choice is grayed out, and if sent from SCPI generates error -221: "Settings conflict; marker cannot be relative to itself." When queried a single value is returned (the specified marker numbers relative marker). You must be in the Spectrum Analysis mode, WCDMA mode, TD-SCDMA mode, 1xEVDO mode, WIMAX OFDMA mode ISDB-T mode, WLAN mode, CMMB mode, LTE mode, LTETDD mode or BLUETOOTH mode to use this command. Use:INSTRument:SElect to set the mode.
Preset	2 3 4 5 6 7 8 9 10 11 12 1
State Saved	Saved in instrument state.
Min	1
Max	12
Readback	Current selected relative to marker number.
Initial S/W Revision	Prior to A.02.00
Modified at S/W Revision	A.03.00

All Markers Off

Turns off all markers.

Key Path	Marker
Mode	SA, WCDMA, C2K, WIMAX OFDMA, TD-SCDMA, 1xEVDO, ISDB-T, CMMB, LTE, LTETDD, BLUETOOTH, WLAN, MSR
Remote Command	:CALCulate:OBWidth:MARKer:AOff
Example	CALC:OBW:MARK:AOff
Initial S/W Revision	Prior to A.02.00
Modified at S/W Revision	A.03.00

Backward Compatibility SCPI Commands

Sets or queries the state of a marker. Setting a marker which is OFF to state ON or 1 puts it in Normal mode and places it at the center of the screen.

Key Path	SCPI only
Mode	SA, WCDMA, C2K, WIMAX OFDMA, TD-SCDMA, 1xEVDO, ISDB-T, CMMB, LTE, LTETDD, BLUETOOTH, WLAN, MSR
Remote Command	:CALCulate:OBWidth:MARKer[1] 2 3 4 5 6 7 8 9 10 11 12:STATe OFF ON 0 1 :CALCulate:OBWidth:MARKer[1] 2 3 4 5 6 7 8 9 10 11 12:STATe?
Example	CALC:OBW:MARK3:STAT ON CALC:OBW:MARK3:STAT?
Preset	OFF
State Saved	Saved in instrument state.
Initial S/W Revision	Prior to A.02.00
Modified at S/W Revision	A.03.00

Marker Function

There are no 'Marker Functions' supported in this measurement.

Key Path	Front panel key
Initial S/W Revision	Prior to A.02.00

Marker To

There is no 'Marker To' functionality supported in this measurement.

Key Path	Front panel key
Initial S/W Revision	Prior to A.02.00

Meas

See “Meas” on page 1520 for more information.

Key Path	Front-panel key
Initial S/W Revision	Prior to A.02.00

Meas Setup

Displays the setup menu for the current measurement. The measurement setup parameters include the number of measurement averages used to calculate the measurement result and the averaging mode. The setup menu also includes the option to reset the measurement settings to their factory defaults.

Key Path	Front-panel key
Initial S/W Revision	Prior to A.02.00

Avg/Hold Num

Specifies the number of measurement averages used when calculating the measurement result. The average is displayed at the end of each sweep.

Initiates an averaging routine that averages the sweep points in a number of successive sweeps, resulting in trace smoothing.

After the specified number of average counts, the average mode (termination control) setting determines the average action.

Key Path	Meas Setup
Mode	SA, WCDMA, C2K, WIMAX OFDMA, TD-SCDMA, 1xEVDO, ISDB-T, CMMB, LTE, LTETDD, BLUETOOTH, WLAN, MSR
Remote Command	[:SENSe]:OBWidth:AVERage:COUNT <integer> [:SENSe]:OBWidth:AVERage:COUNT? [:SENSe]:OBWidth:AVERage[:STATe] ON OFF 1 0 [:SENSe]:OBWidth:AVERage[:STATe]?
Example	OBW:AVER:COUN 1500 OBW:AVER:COUN? OBW:AVER ON OBW:AVER?
Notes	You must be in the Spectrum Analysis mode, W-CDMA mode, cdma2000 mode, TD-SCDMA mode, ISDB-T mode, CMMB mode, LTE mode, LTE TDD mode, BLUETOOTH mode, WLAN mode, 1xEVDO mode, MSR or WIMAX OFDMA mode to use this command. Use:INSTrument:SElect to set the mode.
Couplings	None Averaging state is coupled to Max Hold. If Max Hold is changed from Off to On, Averaging state is automatically set to On.
Preset	10 ON

State Saved	Saved in instrument state.
Min	1
Max	10000
Backwards Compatibility SCPI	[:SENSe]:EBWidth:AVERage:COUNT
Initial S/W Revision	Prior to A.02.00
Modified at S/W Revision	A.03.00

Avg Mode

Enables you to set the averaging mode.

When set to Exponential (Exp) the measurement averaging continues using the specified number of averages to compute each averaged value. The average is displayed at the end of each sweep.

When set to Repeat, the measurement resets the average counter each time the specified number of averages is reached.

Key Path	Meas Setup
Mode	SA, WCDMA, C2K, WIMAX OFDMA, TD-SCDMA , 1xEVDO, ISDB-T, CMMB, LTE, LTETDD, BLUETOOTH, WLAN, MSR
Remote Command	[:SENSe]:OBWidth:AVERage:TCONtrol EXPonential REPeat [:SENSe]:OBWidth:AVERage:TCONtrol?
Example	OBW:AVER:TCON REP OBW:AVER:TCON?
Notes	You must be in the Spectrum Analysis mode, W-CDMA mode, cdma2000 mode, TD-SCDMA mode, ISDB-T mode, CMMB mode, LTE mode, LTE TDD mode, BLUETOOTH mode, WLAN mode, 1xEVDO mode, MSR or WIMAX OFDMA mode to use this command. Use:INSTRument:SElect to set the mode.
Preset	EXP
State Saved	Saved in instrument state.
Range	Exp Repeat
Initial S/W Revision	Prior to A.02.00
Modified at S/W Revision	A.03.00

Max Hold (Remote Command Only)

When On, Max Hold displays and holds the maximum responses of the current measurement. Turn Max

Occupied Bandwidth Measurement

Meas Setup

Hold to Off to disable the maximum hold feature.

Mode	SA, WCDMA, C2K, WIMAX OFDMA, TD-SCDMA, 1xEVDO, ISDB-T, CMMB, LTE, LTETDD, BLUETOOTH, WLAN, MSR
Remote Command	[:SENSE]:OBWidth:MAXHold ON OFF 1 0 [:SENSE]:OBWidth:MAXHold?
Example	OBW:MAXH ON OBW:MAXH?
Notes	You must be in the Spectrum Analysis mode, W-CDMA mode, cdma2000 mode, TD-SCDMA mode, ISDB-T mode, CMMB mode, LTE mode, LTE TDD mode, BLUETOOTH mode, WLAN mode, 1xEVDO mode, MSR or WIMAX OFDMA mode to use this command. Use:INSTrument:SElect to set the mode.
Couplings	Max Hold is coupled to Average/Hold state. The Max Hold function is activated only if Average state is On. If Max Hold is changed to On when Average state is Off, Average state is automatically set to On.
Preset	OFF
State Saved	Saved in instrument state.
Range	On Off
Backwards Compatibility SCPI	[:SENSE]:EBWidth:MAXHold
Initial S/W Revision	Prior to A.02.00
Modified at S/W Revision	A.03.00

Occ BW % Pwr

Assigns the percentage of the total power that is measured within the Occupied Bandwidth for the current measurement. The resulting Occupied Bandwidth limits are displayed by markers placed on the frequencies of the specified percentage.

Key Path	Meas Setup
Mode	SA, WCDMA, C2K, WIMAX OFDMA, TD-SCDMA, 1xEVDO, ISDB-T, CMMB, LTE, LTETDD, BLUETOOTH, WLAN, MSR
Remote Command	[:SENSE]:OBWidth:PERCent <real> [:SENSE]:OBWidth:PERCent?
Example	OBW:PERC 75 OBW:PERC?

Notes	You must be in the Spectrum Analysis mode, W-CDMA mode, cdma2000 mode, TD-SCDMA mode, ISDB-T mode, CMMB mode, LTE mode, LTE TDD mode, BLUETOOTH mode, WLAN mode, 1xEVDO mode, MSR or WIMAX OFDMA mode to use this command. Use:INSTRument:SElect to set the mode. If Mode is BLUETOOTH, the key will be grayed out.
Preset	99.00
State Saved	Saved in instrument state.
Min	10
Max	99.99
Initial S/W Revision	Prior to A.02.00
Modified at S/W Revision	A.03.00

x dB

Sets the x dB value used for the "x dB bandwidth" result that measures the bandwidth between two points on the signal which is x dB down from the highest signal point within the OBW Span.

Key Path	Meas Setup
Mode	SA, WCDMA, C2K, WIMAX OFDMA, TD-SCDMA, 1xEVDO, ISDB-T, CMMB, LTE, LTETDD, BLUETOOTH, WLAN, MSR
Remote Command	[:SENSE] :OBWidth :XDB <rel_ampl> [:SENSE] :OBWidth :XDB?
Example	OBW:XDB -20 OBW:XDB?
Notes	You must be in the Spectrum Analysis mode, W-CDMA mode, cdma2000 mode, TD-SCDMA mode, ISDB-T mode, CMMB mode, LTE mode, LTE TDD mode, BLUETOOTH mode, WLAN mode, 1xEVDO mode, MSR or WIMAX OFDMA mode to use this command. Use:INSTRument:SElect to set the mode.
Preset	-26.0 dB BLUETOOTH: -20.0 dB.
State Saved	Saved in instrument state.
Min	-100.0 dB
Max	-0.1 dB
Backwards Compatibility SCPI	[:SENSe] :EBWidth :XDB
Initial S/W Revision	Prior to A.02.00
Modified at S/W Revision	A.03.00

IF Gain

The **IF Gain** key can be used to set the IF Gain function to Auto, Low Gain or High Gain. These settings affect sensitivity and IF overloads.

This only applies to the RF input. It does not apply to baseband I/Q input.

Key Path	Meas Setup, IF Gain
Initial S/W Revision	Prior to A.02.00

IF Gain Auto

Activates the Auto Rules for IF Gain. When Auto is active, the IF Gain is set to High Gain under and of the following conditions:

- the input attenuator is set to 0 dB
- the preamp is turned On and the frequency range is under 3.6 GHz

For other settings, Auto sets the IF Gain to Low Gain.

Key Path	Meas Setup, IF Gain
Mode	SA, WCDMA, C2K, WIMAX OFDMA, TD-SCDMA, 1xEVDO, ISDB-T, CMMB, LTE, LTETDD, BLUETOOTH, WLAN, MSR
Remote Command	[:SENSE] :OBWidth:IF:GAIN:AUTO[:STATE] ON OFF 1 0 [:SENSE] :OBWidth:IF:GAIN:AUTO[:STATE]?
Example	OBW:IF:GAIN:AUTO OFF OBW:IF:GAIN:AUTO?
Couplings	When the auto attenuation exists (for example, with electrical attenuator), the IF Gain setting is changed as following rule. Auto sets IF Gain to High Gain under any of the following conditions: the input attenuator is set to 0 dB, or the preamp is turned on and the frequency range is less than 3.6 GHz. For other settings, Auto sets IF Gain to Low Gain.
Preset	OFF
State Saved	Saved in instrument state.
Range	Off On
Initial S/W Revision	Prior to A.02.00
Modified at S/W Revision	A.03.00

IF Gain State

Selects the range of the IF Gain.

Key Path	Meas Setup, IF Gain
----------	----------------------------

Mode	SA, WCDMA, C2K, WIMAX OFDMA, TD-SCDMA, 1xEVDO, ISDB-T, CMMB, LTE, LTETDD, BLUETOOTH, WLAN, MSR
Remote Command	[:SENSe]:OBwidth:IF:GAIN[:STATe] ON OFF 1 0 [:SENSe]:OBwidth:IF:GAIN[:STATe]?
Example	OBW:IF:GAIN ON OBW:IF:GAIN?
Notes	Where ON = high gain OFF = low gain
Couplings	When the auto attenuation exists (for example, with electrical attenuator), the IF Gain setting is changed as following rule. Auto sets IF Gain to High Gain under any of the following conditions: the input attenuator is set to 0 dB, or the preamp is turned on and the frequency range is less than 3.6 GHz. For other settings, Auto sets IF Gain to Low Gain.
Preset	OFF
State Saved	Saved in instrument state.
Range	Low Gain High Gain
Initial S/W Revision	Prior to A.02.00
Modified at S/W Revision	A.03.00

Limit (for all modes except MSR)

Enables you to turn on or off limit checking at the specified frequency. For results that fail the limit test, a red FAIL appears in the measure bar.

Key Path	Meas Setup
Mode	SA, WCDMA, C2K, WIMAX OFDMA, TD-SCDMA, 1xEVDO, ISDB-T, CMMB, LTE, LTETDD, BLUETOOTH, WLAN
Remote Command	:CALCulate:OBwidth:LIMit:FBLimit <freq> :CALCulate:OBwidth:LIMit:FBLimit? :CALCulate:OBwidth:LIMit[:TEST] ON OFF 1 0 :CALCulate:OBwidth:LIMit[:TEST]?
Example	CALC:OBW:LIM:FBL 50 kHz CALC:OBW:LIM:FBL? CALC:OBW:LIM OFF CALC:OBW:LIM?

Occupied Bandwidth Measurement
Meas Setup

Notes	You must be in the Spectrum Analysis mode, W-CDMA mode, cdma2000 mode, TD-SCDMA mode, ISDB-T mode, CMMB mode, LTE mode, LTE TDD mode, BLUETOOTH mode, WLAN mode, 1xEVDO mode or WIMAX OFDMA mode to use this command. Use:INSTRument:SElect to set the mode.
Preset	SA, WCDMA: 5 MHz C2K: 1.48 MHz WIMAX OFDMA: 10 MHz TD-SCDMA: 1.6 MHz 1xEVDO: 1.48 MHz ISDB-T: 5.7 MHz CMMB: 7.512 MHz LTE, LTETDD: 5 MHz BLUETOOTH: 1 MHz WLAN: If Radio Std is 802.11a/g(OFDM/DSSS-OFDM): 16.6MHz If Radio Std is 802.11b: 22 MHz If Radio Std is 802.11n(20MHz): 17.8 MHz If Radio Std is 802.11n(40MHz): 36.6 MHz SA: OFF WCDMA, WIMAX OFDMA, TD-SCDMA, 1xEVDO, ISDB-T, CMMB, LTE, LTETDD: ON
State Saved	Saved in instrument state.
Min	1 kHz
Max	Hardware Dependent: Option 503 = 3.7 GHz Option 507 = 7.1 GHz Option 508 = 8.5 GHz Option 513 = 13.8 GHz Option 526 = 27.0 GHz
Initial S/W Revision	Prior to A.02.00
Modified at S/W Revision	A.03.00

Limit (for MSR mode)

Access to Limit menu.

Key Path	Meas Setup
Initial S/W Revision	A.10.00

Limit Test

Toggles the limit test.

Key Path	Meas Setup, Limit
Mode	MSR
Remote Command	:CALCulate:OBwidth:LIMit[:TEST] ON OFF 1 0 :CALCulate:OBwidth:LIMit[:TEST]?
Example	CALC:OBW:LIM 0 CALC:OBW:LIM?
Preset	OFF
State Saved	Saved in instrument state
Range	On Off
Initial S/W Revision	A.10.00

Bandwidth

Sets OBW limit.

Key Path	Meas Setup, Limit
Mode	MSR
Remote Command	:CALCulate:OBwidth:LIMit:FBLimit <freq> :CALCulate:OBwidth:LIMit:FBLimit?
Example	CALC:OBW:LIM:FBL 10 CALC:OBW:LIM:FBL?
Preset	5.0000 MHz
State Saved	Saved in instrument state
Min	1 kHz
Max	Depends on instrument maximum frequency.
Initial S/W Revision	A.10.00

Meas Preset

Restores all measurement parameters to their default values.

Key Path	Meas Setup
Mode	SA, WCDMA, C2K, WIMAX OFDMA, TD-SCDMA, 1xEVDO, ISDB-T, CMMB, LTE, LTETDD, BLUETOOTH, WLAN, MSR
Remote Command	:CONFigure:OBWidth
Example	CONF:OBW
Initial S/W Revision	Prior to A.02.00
Modified at S/W Revision	A.03.00

Mode

See “Mode” on page 1534 for more information.

Key Path	Front-panel key
Initial S/W Revision	Prior to A.02.00

Mode Setup

See “[Mode Setup](#)” on page 1553 for more information.

Key Path	Front-panel key
Initial S/W Revision	Prior to A.02.00

Peak Search

Places the selected marker on the trace point with the maximum y-axis value for that marker's trace. Pressing Peak Search with the selected marker off causes the selected marker to be set to Normal, then a peak search is immediately performed.

Key Path	Front panel key
Mode	SA, WCDMA, C2K, WIMAX OFDMA, TD-SCDMA, 1xEVDO, ISDB-T, CMMB, LTE, LTETDD, BLUETOOTH, WLAN, MSR
Remote Command	:CALCulate:OBwidth:MARKer[1] 2 3 4 5 6 7 8 9 10 11 12:MAXimum
Example	CALC:OBW:MARK2:MAX
Initial S/W Revision	Prior to A.02.00
Modified at S/W Revision	A.03.00

Recall

See “[Recall](#)” on page 194 for more information.

Key Path	Front-panel key
Initial S/W Revision	Prior to A.02.00

Restart

See “Restart” on page 1558 for more information.

Key Path	Front-panel key
Initial S/W Revision	Prior to A.02.00

Save

See “[Save](#)” on page 207 for more information.

Key Path	Front-panel key
Initial S/W Revision	Prior to A.02.00

Single

See “[Single \(Single Measurement/Sweep\)](#)” on page 1563 for more information.

Key Path	Front-panel key
Initial S/W Revision	Prior to A.02.00

Source

Operation of this key is identical across all measurements. For details about this key, see [“Source” on page 1564](#).

Key Path	Front-panel key
Initial S/W Revision	Prior to A.02.00

Span X Scale

Activates the Span function and displays the menu of span functions. The parameter values are measurement independent.

Key Path	Front-panel key
Initial S/W Revision	Prior to A.02.00

Span

Set the frequency of the occupied bandwidth span for the current measurement.

Key Path	Span X Scale
Mode	SA, WCDMA, C2K, WIMAX OFDMA, TD-SCDMA, 1xEVDO, ISDB-T, CMMB, LTE, LTETDD, BLUETOOTH, WLAN, MSR
Remote Command	[:SENSe]:OBWidth:FREQuency:SPAN <freq> [:SENSe]:OBWidth:FREQuency:SPAN? [:SENSe]:OBWidth:FREQuency:SPAN:AUTO ON OFF 0 1 [:SENSe]:OBWidth:FREQuency:SPAN:AUTO?
Example	OBW:FREQ:SPAN 2.4 MHz OBW:FREQ:SPAN? OBW:FREQ:SPAN:AUTO 0 OBW:FREQ:SPAN:AUTO?
Notes	Span Auto Detector ([:SENSe]:OBWidth:FREQuency:SPAN:AUTO) is only available in MSR mode. The BAF SCPI is MSR only.
Couplings	When changing the Occupied Bandwidth Span, the Resolution Bandwidth and Video Bandwidth are set to AUTO to prevent the span from clipping.

Occupied Bandwidth Measurement
Span X Scale

Preset	SA: 3 MHz WCDMA: 10 MHz WIMAX OFDMA: 20 MHz CDMA2K: 2 MHz TD-SCDMA: 4.8 MHz 1xEVDO: 3.75 MHz ISDB-T: 20 MHz CMMB: 8 MHz LTE, LTETDD: 20 MHz BLUETOOTH:2 MHz WLAN: If Radio Std is 802.11a/b/g 802.11n(20MHz): 25 MHz If Radio Std is 802.11n(40MHz): 50 MHz MSR: 20MHz ON
State Saved	Saved in instrument state.
Min	100 Hz
Max	Hardware Dependent: Option 503 = 3.7 GHz Option 507 = 7.1 GHz Option 508 = 8.5 GHz Option 513 = 13.8 GHz Option 526 = 27.0 GHz
Backwards Compatibility SCPI	[:SENSe]:EBWidth:FREQuency:SPAN
Initial S/W Revision	Prior to A.02.00
Modified at S/W Revision	A.03.00, A.10.00

Full Span

Changes the Occupied Bandwidth Span to show the full frequency range of the analyzer. When using external mixing, it changes the displayed frequency span to the frequency range specified for the selected external mixing band.

Key Path	Span X Scale
Mode	SA, WCDMA, C2K, WIMAX OFDMA, ISDB-T, CMMB, LTE, LTETDD, BLUETOOTH, WLAN, MSR

Remote Command	[:SENSE] :OBWidth:FREQuency:SPAN:FULL
Example	OBW:FREQ:SPAN:FULL
Notes	You must be in the Spectrum Analysis mode, W-CDMA mode, ISDB-T mode, CM MB mode, LTE mode, LTE TDD mode, BLUETOOTH mode, WLAN mode, cdma2000 mode, MSR or WIMAX OFDMA mode to use this command. Use:INSTrument:SElect to set the mode.
Couplings	Selecting full span changes the measurement span value.
Initial S/W Revision	Prior to A.02.00
Modified at S/W Revision	A.03.00

Last Span

Changes the measurement frequency span to previous measurement span setting. If there is no existing previous span value then the span remains unchanged.

Key Path	Span X Scale
Mode	SA, WCDMA, C2K, WIMAX OFDMA, ISDB-T, CM MB, LTE, LTETDD, BLUETOOTH, WLAN, MSR
Remote Command	[:SENSE] :OBWidth:FREQuency:SPAN:PREVIOUS
Example	OBW:FREQ:SPAN:PREV
Notes	You must be in the Spectrum Analysis mode, W-CDMA mode, ISDB-T mode, CM MB mode, LTE mode, LTE TDD mode, BLUETOOTH mode, WLAN mode, cdma2000 mode, MSR or WIMAX OFDMA mode to use this command. Use:INSTrument:SElect to set the mode.
Couplings	Selecting last span changes the measurement span value.
Initial S/W Revision	Prior to A.02.00
Modified at S/W Revision	A.03.00

Sweep/Control

Displays a menu of functions that enable you to set up and control the sweep time and source for the current measurement.

For details about this key, see “Sweep/Control” on page 1564.

Key Path	Front-panel key
Initial S/W Revision	Prior to A.02.00

Sweep Time

Selects the length of time in which the spectrum analyzer sweeps the displayed frequency span. Additional overhead time, which impacts the sweep rate, is not calculated as part of the sweep time. In fact:

sweep rate = span/sweep time

update rate = 1/(sweep time + overhead)

sweep cycle time = sweep time + overhead

Sweep time is coupled to RBW and VBW, and is impacted by the number of sweep points, so changing those parameters may change the sweep time.

This is not available when the selected input is I/Q.

Key Path	Sweep/Control
Mode	SA, WCDMA, C2K, WIMAX OFDMA, TD-SCDMA, 1xEVDO, ISDB-T, CMMB, LTE, LTETDD, BLUETOOTH, WLAN, MSR
Remote Command	[:SENSe]:OBWidth:SWEep:TIME <time> [:SENSe]:OBWidth:SWEep:TIME? [:SENSe]:OBWidth:SWEep:TIME:AUTO OFF ON 0 1 [:SENSe]:OBWidth:SWEep:TIME:AUTO?
Example	OBW:SWE:TIME 50 ms OBW:SWE:TIME? OBW:SWE:TIME:AUTO ON OBW:SWE:TIME:AUTO?
Couplings	When you manually change the Sweep Time, this state automatically goes to ‘Man’.

Preset	SA,WIMAX OFDMA, C2K, TD-SCDMA, 1xEVDO, ISDB-T, CMMB, LTE, LTETDD, BLUETOOTH, WLAN, MSR: Automatically Calculated WCDMA: 32.6 ms SA, WIMAX OFDMA, C2K, TD-SCDMA, 1xEVDOISDB-T, CMMB, LTE, LTETDD, WLAN, MSR: ON WCDMA: OFF
State Saved	Saved in instrument state.
Min	1 ms
Max	4000 s
Initial S/W Revision	Prior to A.02.00
Modified at S/W Revision	A.03.00

Sweep Setup

Accesses the sweep setup settings for the current measurement.

Key Path	Sweep/Control
Initial S/W Revision	Prior to A.02.00

Auto Sweep Time Rules

Switches the analyzer between normal and accuracy sweep states.

Setting Auto Sweep Time to Accy results in slower sweep times, usually about three times as long, but better amplitude accuracy for CW signals. The instrument amplitude accuracy specifications only apply when Auto Sweep Time is set to Accy.

Additional amplitude errors which occur when Auto Sweep Time is set to Norm are usually well under 0.1 dB, though this is not guaranteed. Because of the faster sweep times and still low errors, Norm is the preferred setting of Auto Sweep Time. Auto Sweep Time is set to Norm on a Preset or Auto Couple. This means that in the Preset or Auto Coupled state, instrument amplitude accuracy specifications do not apply.

Key Path	Sweep/Control, Sweep Setup
Mode	SA, WCDMA, C2K, WIMAX OFDMA, TD-SCDMA, 1xEVDO, ISDB-T, CMMB, LTE, LTETDD, BLUETOOTH, WLAN, MSR
Remote Command	[:SENSE] :OBWidth :SWEep :TIME :AUTO :RULEs NORMal ACCuracy [:SENSE] :OBWidth :SWEep :TIME :AUTO :RULEs ?
Example	OBW:SWE:TIME:AUTO:RUL NORM OBW:SWE:TIME:AUTO:RUL ?
Notes	Set to Norm when Auto Couple is pressed or sent remotely.

Occupied Bandwidth Measurement
Sweep/Control

Preset	NORMal
State Saved	Saved in instrument state.
Range	Norm Accy
Initial S/W Revision	Prior to A.02.00
Modified at S/W Revision	A.03.00

Pause

Pauses the measurement after the current data acquisition is complete.

When Paused, the label on the key changes to Resume. Pressing the Resume key resumes the measurement at the point where it had been paused.

See [“Pause/Resume” on page 1577](#) for more information.

Key Path	Sweep/Control
Initial S/W Revision	Prior to A.02.00

Gate

Accesses a menu that enables you to control the gating function.

The Gate functionality is used to view signals best viewed by qualifying them with other events.

This function is not available when the selected input is I/Q.

See [“Gate ” on page 1578](#) for more information.

Key Path	Sweep/Control
Initial S/W Revision	Prior to A.02.00

Points

Sets the number of points per sweep. The resolution of setting the sweep time depends on the number of points selected. The current value of points is displayed parenthetically, next to the sweep time in the lower-right corner of the display.

Key Path	Sweep/Control
Mode	SA, WCDMA, C2K, WIMAX OFDMA, TD-SCDMA, 1xEVDO, ISDB-T, CMMB, LTE, LTETDD, BLUETOOTH, WLAN, MSR
Remote Command	[:SENSe] :OBWidth :SWEep :POINts <integer> [:SENSe] :OBWidth :SWEep :POINts?
Example	OBW:SWE:POIN 1500 OBW:SWE:POIN?

Notes	<p>This function is not available when signal identification is set to On (external mixing).</p> <p>Affected by:</p> <p>log sweep</p> <p>Grayed out in measurements that don't support swept</p> <p>Blanked in modes that do not support swept.</p> <p>Whenever the number of sweep points change:</p> <ul style="list-style-type: none"> - All trace data is erased - Any traces with Update Off also go to Display Off (like going from View to Blank in the older analyzers) - Sweep time is re-quantized - Any limit lines that are on are updated - If averaging/hold is on, averaging/hold starts over
Couplings	Whenever the number of sweep points change, the sweep time is re-quantized.
Preset	1001
State Saved	Saved in instrument state.
Min	101
Max	20001
Initial S/W Revision	Prior to A.02.00
Modified at S/W Revision	A.03.00

Trace/Detector

Accesses a menu of functions that enable you to control the detectors for the current measurement.

Key Path	Front-panel key
Initial S/W Revision	Prior to A.02.00

Trace Type

Allows you to select the type of trace you want to you use for the current measurement.

The first page of this menu contains a 1-of-N selection of the trace type (Clear Write, Average, Max Hold, Min Hold) for the selected trace.

Key Path	Trace/Detector
Mode	SA, WCDMA, C2K, WIMAX OFDMA, TD-SCDMA, 1xEVDO, ISDB-T, CMMB, LTE, LTETDD, BLUETOOTH, WLAN, MSR
Remote Command	:TRACe:OBWidth:TYPE WRITe AVERAge MAXHold MINHold :TRACe:OBWidth:TYPE?
Example	TRAC:OBW:TYPE MINH TRAC:OBW:TYPE?
Notes	WRITe = Clear Write AVERAge = Average MAXHold = Maximum Hold MINHold = Minimum Hold
Couplings	When Detector setting is “Auto” ([[:SENSe]:OBWidth:DETEctor:AUTO?]), Detector ([[:SENSe]:OBWidth:DETEctor[:FUNCTION]?]) switches aligning with the switch of this parameter: “NORMal” with WRITe (Clear Write), “AVERAge” with AVERAge, “POSitive (peak)” with MAXHold, and “NEGative (peak)” with MINHold.
Preset	AVERAge BLUETOOTH: MAX HOLD.
State Saved	Saved in instrument state.
Range	WRITe AVERAge MAXHold MINHold
Initial S/W Revision	Prior to A.02.00
Modified at S/W Revision	A.03.00

Detector

Accesses a menu of functions that enables you to control the detectors for the current measurement. The following choices are available:

- Auto- the detector selected depends on marker functions, trace functions, average type, and the trace averaging function.
- Normal-the detector determines the peak of the CW-like signals, and it yields alternating maximums and minimums of noise-like signals. This is also referred to as Rosenfell detection.
- Average-the detector determines the average of the signal within the sweep points. The averaging method depends upon the Average Type selection (voltage, power or log scales).
- Peak (Positive)-the detector determines the maximum of the signal within the sweep points.
- Sample-the detector indicates the instantaneous level of the signal at the center of the sweep points represented by each display point.
- Negative Peak-the detector determines the minimum of the signal within the sweep points.

Key Path	Detector
Initial S/W Revision	Prior to A.02.00

Detector Selection

Allows you to select a specific detector for the current measurement. When the detector choice is Auto, the analyzer selects the detector. The selected detector depends on marker functions, trace functions, and trace averaging functions for the current measurement.

Key Path	Trace/Detector
Mode	SA, WCDMA, C2K, WIMAX OFDMA, TD-SCDMA, 1xEVDO, ISDB-T, CMMB, LTE, LTETDD, BLUETOOTH, WLAN, MSR
Remote Command	[:SENSE] : OBWidth : DETector [:FUNCTION] NORMAL AVERAGE POSITIVE SAMPLE NEGATIVE [:SENSE] : OBWidth : DETector [:FUNCTION] ?
Example	OBW:DET NORM OBW:DET?

Notes	<p>When you manually select a detector (instead of selecting Auto), that detector is used regardless of other analyzer settings.</p> <p>The detector choices are:</p> <p>The Normal detector determines the peak of CW-like signals, and it yields alternating maximums and minimums of noise-like signals. This is also referred to as Rosenfell detection.</p> <p>The Average detector determines the average of the signal within the sweep points. The averaging method is Power Average (RMS).</p> <p>The Peak detector determines the maximum of the signal within the sweep points.</p> <p>The Sample detector indicates the instantaneous level of the signal at the center of the sweep points represented by each display point.</p> <p>The Negative Peak detector determines the minimum of the signal within the sweep points.</p>
Couplings	<p>When Detector setting is “Auto” ([:SENSe]:OBWidth:DETEctor:AUTO?), Detector ([:SENSe]:OBWidth:DETEctor[:FUNctio]?) switches aligning with the switch of this parameter: “NORMal” with Clear Write, “AVERage” with AVERage, “POSitive (peak)” with MAXHold, and “NEGative (peak)” with MINHold.</p>
Preset	<p>AVERage</p> <p>ISDB-T: Peak</p> <p>BLUETOOTH: Peak</p>
State Saved	Saved in instrument state.
Range	Normal Average Peak Sample Negative Peak
Initial S/W Revision	Prior to A.02.00
Modified at S/W Revision	A.03.00

Auto

When the detector choice is Auto, the analyzer selects the detector. The selected detector depends on marker functions, trace functions, and trace averaging functions for the current measurement.

Key Path	Trace/Detector
Remote Command	[:SENSe]:OBWidth:DETEctor:AUTO ON OFF 1 0 [:SENSe]:OBWidth:DETEctor:AUTO?
Example	OBW:DET:AUTO ON OBW:DET:AUTO?

Couplings	When Detector setting is “Auto” (:SENSe]:OBWidth:DETEctor:AUTO?), Detector (:SENSe]:OBWidth:DETEctor[:FUNCTion]?) switches aligning with the switch of this parameter: “NORMal” with Clear Write, “AVERage” with AVERage, “POSitive (peak)” with MAXHold, and “NEGative (peak)” with MINHold.
Preset	ON ISDB-T: OFF
State Saved	Saved in instrument state.
Initial S/W Revision	Prior to A.02.00
Modified at S/W Revision	A.03.00

Trigger

See “[Trigger](#)” on page 1595 for information about all keys in this menu.

Key Path	Front-panel key
Initial S/W Revision	Prior to A.02.00

View/Display

Accesses a menu of functions that enable you to set the view and display parameters for the current measurement.

The following result descriptions are available:

Occupied Bandwidth

The occupied bandwidth result is $f_2 - f_1$, where f_1 and f_2 are calculated.

Total Power

The total power is the power integrated in the specified span setting.

Transmit Freq Error

The transmit freq error (transmit frequency error) result is calculated as the difference between $(f_2+f_1)/2$ and the tuned center frequency of the signal, where f_1 and f_2 are calculated.

x dB Bandwidth

The x dB result is a bandwidth measured between two points on the signal which are a certain number of dBs down from the highest signal point within the OBW Span. For example, If the 'x dB' parameter is set to -26 dB, and the 'Occupied BW Span' is set to 10 MHz, then the maximum signal power level is first determined from the 10 MHz wide trace sweep. Next, the two furthest frequencies below (xdb_{f_1}) and above (xdb_{f_2}) the frequency of the maximum level occurrence are found where the signal level is 26 dB below the peak level. This calculation also uses linear interpolation to find the lower and upper carrier boundary point within the width of a sweep point (the span divided by the number of sweep points).

The x dB bandwidth is calculated to be $xdb_{f_2} - xdb_{f_1}$.

View

There is a single results view available for this measurement.

Spectrum View

NOTE An asterisk next to the x dB bandwidth value indicates the results may not have been determined with optimal analyzer settings. If this result (emission bandwidth) is your primary interest, select Meas Setup, Max Hold, On. Then change the detector mode to peak. Acquiring peak data ensures accuracy of the result.

For SA, WCDMA, C2K, 1xEVDO, WIMAX OFDMA, WLAN mode:

Occupied Bandwidth Measurement
View/Display

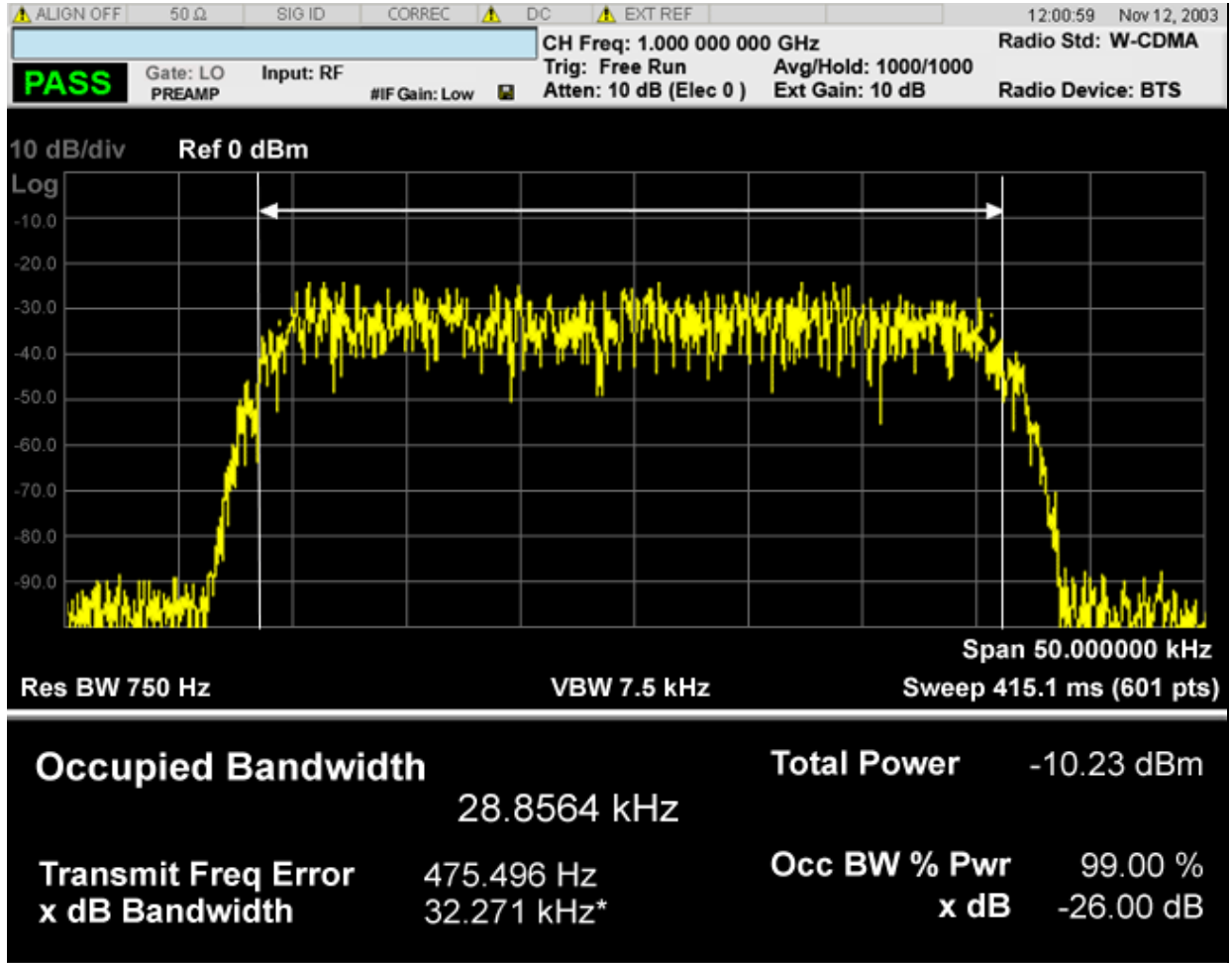

For TD-SCDMA mode only:

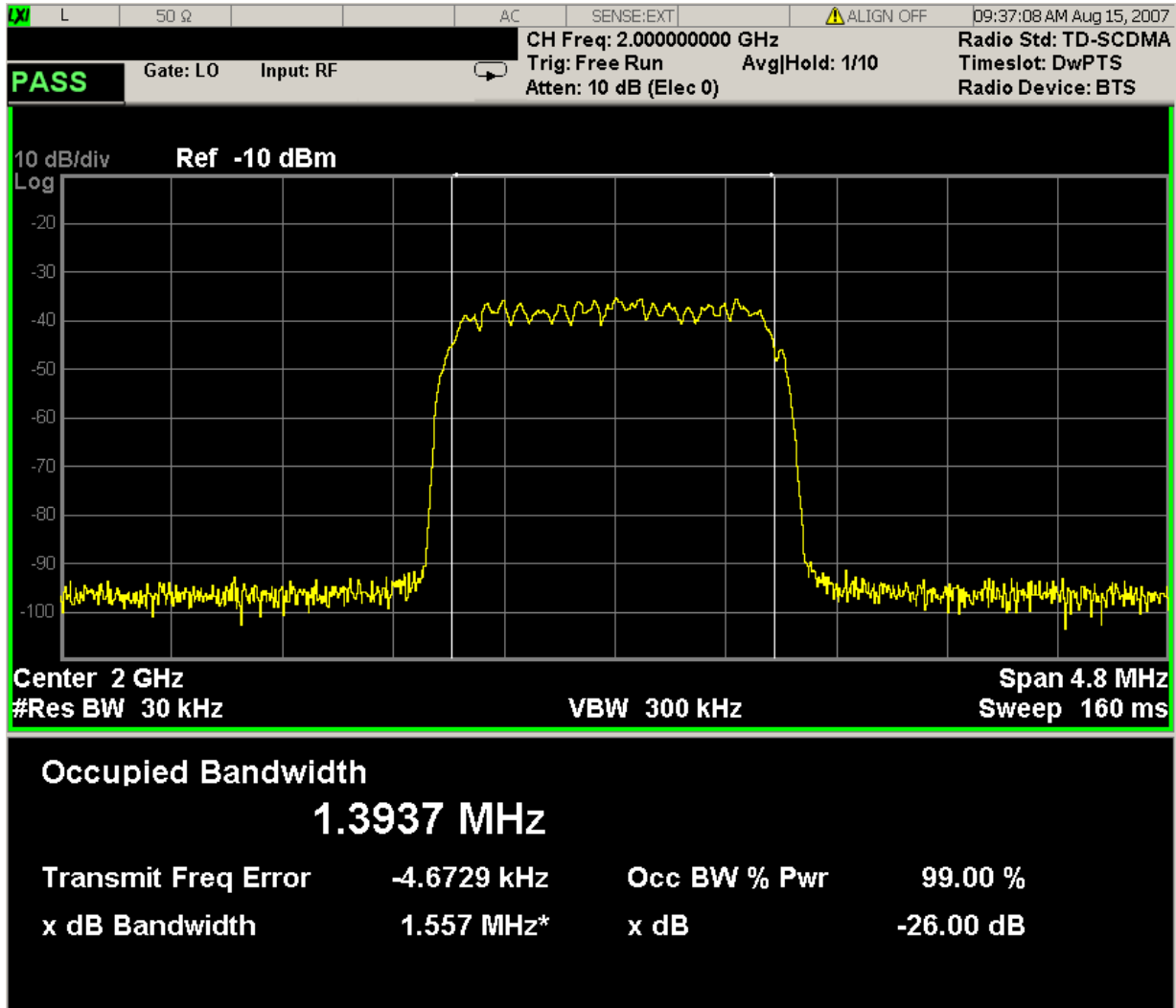

For Bluetooth Only:

Occupied Bandwidth Measurement
View/Display

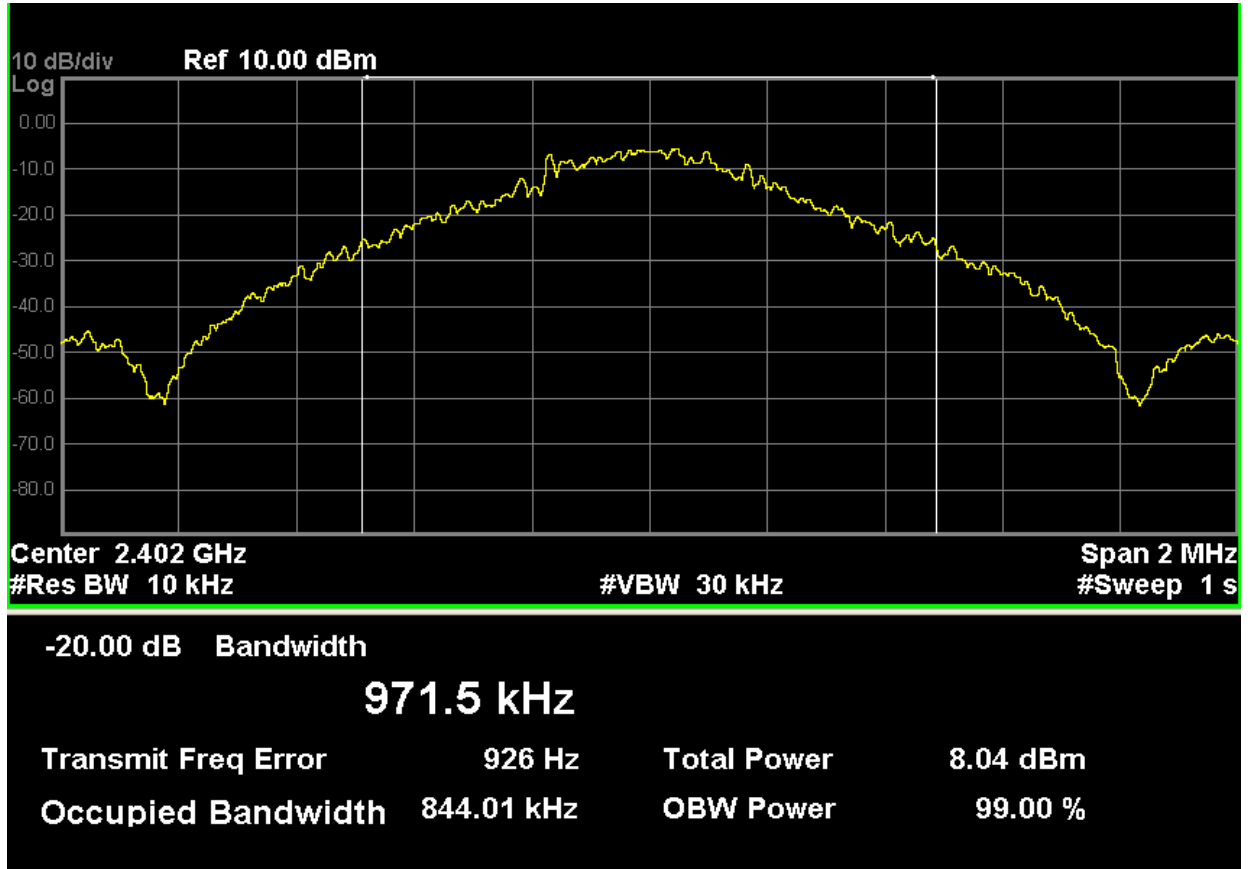

For MSR mode:

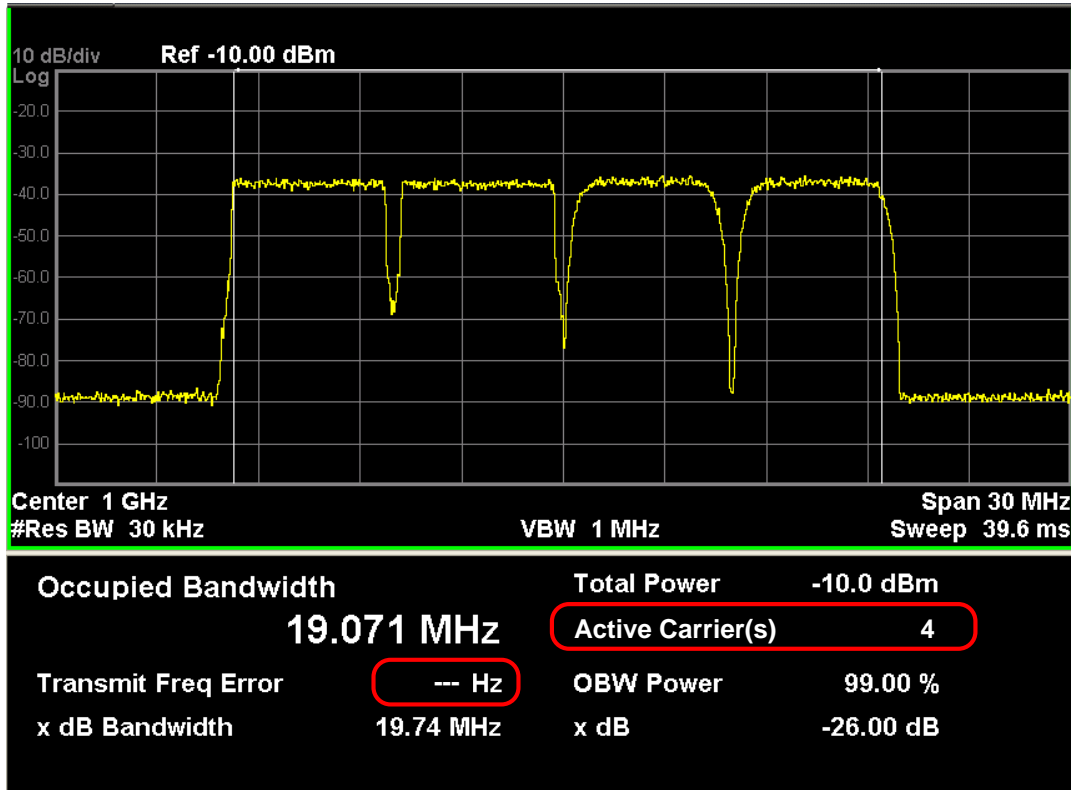

Number of active carriers is displayed. Since span is determined from detected carriers in auto mode, it is required show how many carriers are identified as active.

When active carrier is one, Transmit Freq Error is displayed. Otherwise, “---“ is displayed.

Key Path	Front-panel key
Initial S/W Revision	Prior to A.02.00

Display

Accesses a menu of functions that enable you to set the display parameters.

See “Display” on page 1646 for more information.

Key Path	View/Display
Initial S/W Revision	Prior to A.02.00

ACP is a measurement of the amount of interference, or power, in an adjacent frequency channel. The results are displayed as a bar graph or as spectrum data, with measurement data at specified offsets. For measurement results and views, see [“View/Display” on page 568](#).

For information on how to make measurement using the X-Series Signal Analyzer, see:

Measurement Guide [n9080-90006.pdf].

For information on how to make measurement using the X-Series Signal Analyzer, see:

This topic contains the following sections:

[“Measurement Commands for ACP” on page 457](#)

[“Remote Command Results for ACP Measurement” on page 457](#)

Measurement Commands for ACP

The following commands are used to retrieve the measurement results:

:CONFigure:ACP

:CONFigure:ACP:NDEFault

:INITiate:ACP

:FETCh:ACP[n]?

:READ:ACP[n]?

:MEASure:ACP[n]?

For more measurement related commands, see the SENSE subsystem, and the section [“Remote Measurement Functions” on page 1520](#).

Remote Command Results for ACP Measurement

Condition	N	Results Returned
Mode = SA mode, Radio Std = None, Number of carriers = 1 and only offset A is on	Not specified or n = 1	Returns 3 comma-separated values that correspond to: Reference carrier power, lower-adjacent channel power (dBc), and upper-adjacent channel power (dBc).

Condition	N	Results Returned
<p>Mode = DTMB (CTTB) or CMMB,</p> <p>Radio BW = 8 MHz, Number of carriers = 1 and Meas Type = Total power reference</p>	<p>Not specified or n = 1</p>	<p>Returns 32 comma-separated scalar results, in the following order.</p> <ol style="list-style-type: none"> 1. 0.0 2. Total carrier power (dBm) 3. 0.0 4. Reference carrier power (dBm) 5. Lower offset A - relative power (dB) 6. Lower offset A - absolute power (dBm) 7. Upper offset A - relative power (dB) 8. Upper offset A - absolute power (dBm) 9. Lower offset B - relative power (dB) 10. Lower offset B - absolute power (dBm) 11. Upper offset B - relative power (dB) 12. Upper offset B - absolute power (dBm) ... 25. Lower offset F - relative power (dB) 26. Lower offset F - absolute power (dBm) 27. Upper offset F - relative power (dB) 28. Upper offset F - absolute power (dBm) 29. Inside Adjacent Channel - relative power (dB) 30. Inside Adjacent Channel - absolute power (dBm) 31. Outside Adjacent Channel - relative power (dB) 32. Outside Adjacent Channel - absolute power (dBm) <p>If Radio Device = Exciter, the last four (29, 30, 31 and 32) results returned -999.0.</p> <p>If the results are not available, -999.0 is returned.</p> <p>Note:</p> <ul style="list-style-type: none"> * Inside Adjacent Channel - absolute power: the maximum of the Lower offset A - absolute power and the Upper offset A - absolute power; ** Inside Adjacent Channel - relative power: the result of Reference carrier power subtracted from Inside Adjacent Channel - absolute power; *** Outside Adjacent Channel - absolute power: the root mean square of the absolute power of the offset B upper/lower, the offset C upper/lower and the offset D upper/lower; **** Outside Adjacent Channel - relative power: the result of Reference carrier power subtracted from Outside Adjacent Channel - absolute power;

Condition	N	Results Returned
Mode = DTMB (CTTB) or CMMB, Radio BW = 8 MHz, Number of carriers = 1 and Meas Type = Power spectral density reference	not specified or n = 1	Returns 32 comma-separated scalar results, in the following order. 1. 0.0 2. Total carrier power (dBm/Hz or dBm/MHz) 3. 0.0 4. Reference carrier power (dBm/Hz or dBm/MHz) 5. Lower offset A - relative power (dB) 6. Lower offset A - absolute power (dBm/Hz or dBm/MHz) 7. Upper offset A - relative power (dB) 8. Upper offset A - absolute power (dBm/Hz or dBm/MHz) 9. Lower offset B - relative power (dB) 10. Lower offset B - absolute power (dBm/Hz or dBm/MHz) 11. Upper offset B - relative power (dB) 12. Upper offset B - absolute power (dBm/Hz or dBm/MHz) ... 25. Lower offset F - relative power (dB) 26. Lower offset F - absolute power (dBm/Hz or dBm/MHz) 27. Upper offset F - relative power (dB) 28. Upper offset F - absolute power (dBm/Hz or dBm/MHz) 29. -999.0 30. -999.0 31. -999.0 32. -999.0 The last four (29, 30, 31 and 32) results always returned -999.0. If the results are not available, -999.0 is returned.

Condition	N	Results Returned
Meas Type = Total power reference	Not specified or n = 1	<p>Returns 28 comma-separated scalar results, in the following order.</p> <ol style="list-style-type: none"> 1. 0.0 2. Total carrier power (dBm) 3. 0.0 4. Reference carrier power (dBm) 5. Lower offset A - relative power (dB) 6. Lower offset A - absolute power (dBm) 7. Upper offset A - relative power (dB) 8. Upper offset A - absolute power (dBm) 9. Lower offset B - relative power (dB) 10. Lower offset B - absolute power (dBm) 11. Upper offset B - relative power (dB) 12. Upper offset B - absolute power (dBm) ... 25. Lower offset F - relative power (dB) 26. Lower offset F - absolute power (dBm) 27. Upper offset F - relative power (dB) 28. Upper offset F - absolute power (dBm) <p>If the results are not available, -999.0 is returned.</p>

Condition	N	Results Returned
Meas Type = Power spectral density reference	not specified or n = 1	<p>Returns 28 comma-separated scalar results, in the following order.</p> <ol style="list-style-type: none"> 1. 0.0 2. Total carrier power (dBm/Hz or dBm/MHz) 3. 0.0 4. Reference carrier power (dBm/Hz or dBm/MHz) 5. Lower offset A - relative power (dB) 6. Lower offset A - absolute power (dBm/Hz or dBm/MHz) 7. Upper offset A - relative power (dB) 8. Upper offset A - absolute power (dBm/Hz or dBm/MHz) 9. Lower offset B - relative power (dB) 10. Lower offset B - absolute power (dBm/Hz or dBm/MHz) 11. Upper offset B - relative power (dB) 12. Upper offset B - absolute power (dBm/Hz or dBm/MHz) ... 25. Lower offset F - relative power (dB) 26. Lower offset F - absolute power (dBm/Hz or dBm/MHz) 27. Upper offset F - relative power (dB) 28. Upper offset F - absolute power (dBm/Hz or dBm/MHz) <p>If the results are not available, -999.0 is returned.</p>
Meas Method = FAST	not specified or n = 1	<p>Returns 5 comma-separated results, in the following order:</p> <ol style="list-style-type: none"> 1. Reference carrier - absolute power (dBm) 2. Lower offset A - absolute power (dBm) 3. Upper offset A - absolute power (dBm) 4. Lower offset B - absolute power (dBm) 5. Upper offset B - absolute power (dBm)

Condition	N	Results Returned
Mode = MSR, Meas Type = Total power reference and Power Ref = Left & Right Carriers	Not specified or n = 1	Returns 28 comma-separated scalar results, in the following order. 1. 0.0 2. Total carrier power (dBm) 3. Left Reference carrier power (dBm) 4. Right Reference carrier power (dBm) 5. Lower offset A - relative power (dB) 6. Lower offset A - absolute power (dBm) 7. Upper offset A - relative power (dB) 8. Upper offset A - absolute power (dBm) 9. Lower offset B - relative power (dB) 10. Lower offset B - absolute power (dBm) 11. Upper offset B - relative power (dB) 12. Upper offset B - absolute power (dBm) ... 25. Lower offset F - relative power (dB) 26. Lower offset F - absolute power (dBm) 27. Upper offset F - relative power (dB) 28. Upper offset F - absolute power (dBm) If the results are not available, -999.0 is returned.

Condition	N	Results Returned
Mode = MSR, Meas Type = Power spectral density reference and Power Ref = Left & Right Carriers	not specified or n = 1	Returns 28 comma-separated scalar results, in the following order. 1. 0.0 2. Total carrier power (dBm/Hz or dBm/MHz) 3. Left reference carrier power (dBm/Hz or dBm/MHz) 4. Right reference carrier power (dBm/Hz or dBm/MHz) 5. Lower offset A - relative power (dB) 6. Lower offset A - absolute power (dBm/Hz or dBm/MHz) 7. Upper offset A - relative power (dB) 8. Upper offset A - absolute power (dBm/Hz or dBm/MHz) 9. Lower offset B - relative power (dB) 10. Lower offset B - absolute power (dBm/Hz or dBm/MHz) 11. Upper offset B - relative power (dB) 12. Upper offset B - absolute power (dBm/Hz or dBm/MHz) ... 25. Lower offset F - relative power (dB) 26. Lower offset F - absolute power (dBm/Hz or dBm/MHz) 27. Upper offset F - relative power (dB) 28. Upper offset F - absolute power (dBm/Hz or dBm/MHz) If the results are not available, -999.0 is returned.

Condition	N	Results Returned
Meas Type = Total power reference	n = 2	<p>Returns 48 scalar results, in the following order:</p> <ol style="list-style-type: none"> 1. Channel (1) - relative power (dB) 2. Channel (1) - absolute power (dBm) 3. Channel (2) - relative power (dB) 4. Channel (2) - absolute power (dBm) ... 23. Channel (12) - relative power (dB) 24. Channel (12) - absolute power (dBm) 25. Lower offset A - relative power (dB) 26. Lower offset A - absolute power (dBm) 27. Upper offset A - relative power (dB) 28. Upper offset A - absolute power (dBm) 29. Lower offset B - relative power (dB) 30. Lower offset B - absolute power (dBm) 31. Upper offset B - relative power (dB) 32. Upper offset B - absolute power (dBm) ... 45. Lower offset F - relative power (dB) 46. Lower offset F - absolute power (dBm) 47. Upper offset F - relative power (dB) 48. Upper offset F - absolute power (dBm) <p>If the results are not available, -999.0 is returned.</p>

Condition	N	Results Returned
Meas Type = Power spectral density reference	n = 2	<p>Returns 48 scalar results, in the following order:</p> <ol style="list-style-type: none"> 1. Channel (1) - relative power (dB) 2. Channel (1) - absolute power (dBm/Hz or dBm/MHz) 3. Channel (2) - relative power (dB) 4. Channel (2) - absolute power (dBm/Hz or dBm/MHz) ... 23. Channel (12) - relative power (dB) 24. Channel (12) - absolute power (dBm/Hz or dBm/MHz) 25. Lower offset A - relative power (dB) 26. Lower offset A - absolute power (dBm/Hz or dBm/MHz) 27. Upper offset A - relative power (dB) 28. Upper offset A - absolute power (dBm/Hz or dBm/MHz) 29. Lower offset B - relative power (dB) 30. Lower offset B - absolute power (dBm/Hz or dBm/MHz) 31. Upper offset B - relative power (dB) 32. Upper offset B - absolute power (dBm/Hz or dBm/MHz) ... 45. Lower offset F - relative power (dB) 46. Lower offset F - absolute power (dBm/Hz or dBm/MHz) 47. Upper offset F - relative power (dB) 48. Upper offset F - absolute power (dBm/Hz or dBm/MHz) <p>If the results are not available, -999.0 is returned.</p>

Condition	N	Results Returned
Mode = DTMB (CTTB) or CMMB, Radio BW = 8 MHz and Meas Type = Total power reference	n = 3	Returns 28 scalar values of the pass/fail (0 = passed, or 1 = failed) determined by testing the relative to the reference carrier and by testing the absolute power limit of the offset frequencies (measured as total power in dB): <ol style="list-style-type: none"> 1. Lower offset A - relative limit result 2. Lower offset A - absolute limit result 3. Upper offset A - relative limit result 4. Upper offset A - absolute limit result 5. Lower offset B - relative limit result 6. Lower offset B - absolute limit result 7. Upper offset B - relative limit result 8. Upper offset B - absolute limit result ... 21. Lower offset F - relative limit result 22. Lower offset F - absolute limit result 23. Upper offset F - relative limit result 24. Upper offset F - absolute limit result 25. Inside Adjacent Channel - relative limit result 26. Inside Adjacent Channel - absolute limit result 27. Outside Adjacent Channel - relative limit result 28. Outside Adjacent Channel - absolute limit result If Radio Device = Exciter, the last four (25, 26, 27 and 28) results returned -999.0.

Condition	N	Results Returned
Mode = DTMB (CTTB) or CMMB, Radio BW = 8 MHz and Meas Type = Power spectral density reference	n = 3	<p>Returns 28 scalar values of the pass/fail (0 = passed, or 1 = failed) determined by testing the relative to the reference carrier and by testing the absolute power limit of the offset frequencies (measured as power spectral density in dB):</p> <ol style="list-style-type: none"> 1. Lower offset A - relative limit result 2. Lower offset A - absolute limit result 3. Upper offset A - relative limit result 4. Upper offset A - absolute limit result 5. Lower offset B - relative limit result 6. Lower offset B - absolute limit result 7. Upper offset B - relative limit result 8. Upper offset B - absolute limit result ... 21. Lower offset F - relative limit result 22. Lower offset F - absolute limit result 23. Upper offset F - relative limit result 24. Upper offset F - absolute limit result 25. -999.0 26. -999.0 27. -999.0 28. -999.0 <p>The last four results always returned -999.0.</p>

Condition	N	Results Returned
Meas Type = Total power reference	n = 3	<p>Returns 24 scalar values of the pass/fail (0 = passed, or 1 = failed) determined by testing the relative to the reference carrier and by testing the absolute power limit of the offset frequencies (measured as total power in dB):</p> <ol style="list-style-type: none"> 1. Lower offset A - relative limit result 2. Lower offset A - absolute limit result 3. Upper offset A - relative limit result 4. Upper offset A - absolute limit result 5. Lower offset B - relative limit result 6. Lower offset B - absolute limit result 7. Upper offset B - relative limit result 8. Upper offset B - absolute limit result ... 21 Lower offset F - relative limit result 22 Lower offset F - absolute limit result 23 Upper offset F - relative limit result 24 Upper offset F - absolute limit result
Meas Type = Power spectral density reference	n = 3	<p>Returns 24 scalar values of the pass/fail (0 = passed, or 1 = failed) determined by testing the relative to the reference carrier and by testing the absolute power limit of the offset frequencies (measured as power spectral density in dB):</p> <ol style="list-style-type: none"> 1. Lower offset A - relative limit result 2. Lower offset A - absolute limit result 3. Upper offset A - relative limit result 4. Upper offset A - absolute limit result 5. Lower offset B - relative limit result 6. Lower offset B - absolute limit result 7. Upper offset B - relative limit result 8. Upper offset B - absolute limit result ... 21 Lower offset F - relative limit result 22 Lower offset F - absolute limit result 23 Upper offset F - relative limit result 24 Upper offset F - absolute limit result
	n = 4	Returns <Num Pts> comma-separated scalar values representing the Y values in Trace 1

Condition	N	Results Returned
	n = 5	Returns <Num Pts> comma-separated scalar values representing the Y values in Trace 2
	n = 6	Returns <Num Pts> comma-separated scalar values representing the Y values in Trace 3
Meas Type = Total power reference	n = 7	<p>Returns (2 * numberOfCarriers) scalar results, in the following order:</p> <p>The numberOfCarriers is the value filled in Carriers under Carrier Setup menu. If license N9060A-5FP is enabled, max value of numberOfCarriers is 18, otherwise, max value of numberOfCarriers is 12. In MSR mode, max value of numberOf Carriers is 100.</p> <ol style="list-style-type: none"> 1. Channel (1) - relative power (dB) 2. Channel (1) - absolute power (dBm) 3. Channel (2) - relative power (dB) 4. Channel (2) - absolute power (dBm) <p>...</p> <p>2 * numberOfCarriers - 1. Channel (numberOfCarriers) - relative power (dB)</p> <p>2 * numberOfCarriers. Channel (numberOfCarriers) - absolute power (dBm)</p> <p>If the results are not available, 9.91E+37 is returned.</p>
Meas Type = Power spectral density reference	n = 7	<p>Returns (2 * numberOfCarriers) scalar results, in the following order: The numberOfCarriers is the value filled in Carriers under Carrier Setup menu.</p> <p>If license N9060A-5FP is enabled, max value of numberOfCarriers is 18, otherwise, max value of numberOfCarriers is 12. In MSR mode, max value of numberOf Carriers is 100.</p> <ol style="list-style-type: none"> 1. Channel (1) - relative power (dB) 2. Channel (1) - absolute power (dBm/Hz or dBm/MHz) 3. Channel (2) - relative power (dB) 4. Channel (2) - absolute power (dBm/Hz or dBm/MHz) <p>...</p> <p>2 * numberOfCarriers - 1. Channel (numberOfCarriers) - relative power (dB)</p> <p>2 * numberOfCarriers. Channel (numberOfCarriers) - absolute power (dBm/Hz or dBm/MHz)</p> <p>If the results are not available, 9.91E+37 is returned</p>

Key Path	Front-panel key
Initial S/W Revision	Prior to A.02.00

AMPTD Y Scale

Accesses a menu of functions that enable you to set the vertical scale parameters. The parameter values are measurement independent, except all Attenuation values and the Internal Preamp selections, which are the same across all measurements.

Key Path	Front-panel key
Initial S/W Revision	Prior to A.02.00

Ref Value

Sets the value for the absolute power reference. However, since the Auto Scaling is defaulted to On, this value is automatically determined by the measurement result. When you set a value manually, Auto Scaling automatically changes to Off.

Key Path	AMPTD Y Scale
Mode	SA, WCDMA, C2K, WIMAX OFDMA, TD-SCDMA, 1xEVDO, DVB-T/H, DTMB (CTTB), ISDB-T, CMMB, LTE, LTETDD, Digital Cable TV, MSR
Remote Command	:DISPlay:ACPower:VIEW[1]:WINDow[1]:TRACe:Y[:SCALE]:RLEV el <real> :DISPlay:ACPower:VIEW[1]:WINDow[1]:TRACe:Y[:SCALE]:RLEV el?
Example	DISP:ACP:VIEW:WIND:TRAC:Y:RLEV 100 DISP:ACP:VIEW:WIND:TRAC:Y:RLEV?
Notes	You must be in the mode that includes ACP measurements to use this command. Use :INSTRument:SElect to set the mode.
Couplings	When the Auto Scaling is On, this value is automatically determined by the measurement result. When you set a value manually, Auto Scaling automatically changes to Off.
Preset	10dBm
State Saved	Saved in instrument state.
Min	-250.00 dBm
Max	250.00 dBm
Initial S/W Revision	Prior to A.02.00
Modified at S/W Revision	A.02.00, A.03.00

Attenuation

Accesses a menu of functions that enable you to change attenuation settings. This key has read-back text

that describes the total attenuator value.

See AMPTD Y Scale, “Attenuation” on page 1381 for more information.

Key Path	AMPTD Y Scale
Initial S/W Revision	Prior to A.02.00

Scale/Div

Sets the units-per-division of the vertical scale in the logarithmic display. However, since the Auto Scaling is defaulted to On, this value is automatically determined by the measurement result. When you set a value manually, Auto Scaling automatically changes to Off.

Key Path	AMPTD Y Scale
Mode	SA, WCDMA, C2K, WIMAX OFDMA, TD-SCDMA, 1xEVDO, DVB-T/H, DTMB (CTTB), ISDB-T, CMMB, LTE, LTETDD, Digital Cable TV, MSR
Remote Command	:DISPlay:ACPpower:VIEW[1]:WINDow[1]:TRACe:Y[:SCALE]:PDIV ision <rel_ampl> :DISPlay:ACPpower:VIEW[1]:WINDow[1]:TRACe:Y[:SCALE]:PDIV ision?
Example	DISP:ACP:VIEW:WIND:TRAC:Y:PDIV 5 DISP:ACP:VIEW:WIND:TRAC:Y:PDIV?
Notes	You must be in the mode that includes ACP measurements to use this command. Use :INSTrument:SELEct to set the mode.
Couplings	When the Auto Scaling is On, this value is automatically determined by the measurement result. When you set a value manually, Auto Scaling automatically changes to Off.
Preset	10.00 dB
State Saved	Saved in instrument state.
Min	0.10 dB
Max	20.00 dB
Initial S/W Revision	Prior to A.02.00
Modified at S/W Revision	A.02.00, A.03.00

Presel Center

When this key is pressed, the centering of the preselector filter is adjusted to optimize the amplitude accuracy at the frequency of the selected marker.

See AMPTD Y Scale, “Presel Center” on page 1396 for more information.

Presel Adjust

Allows you to manually adjust the preselector filter frequency to optimize its response to the signal of interest.

See AMPTD Y Scale, “[Preselector Adjust](#)” on page 1398 for more information.

Y Axis Unit

Allows you to change the vertical (Y) axis amplitude unit.

See “[Y Axis Unit](#)” on page 1399 under AMPTD Y Scale for more information.

Key Path	AMPTD Y Scale
Initial S/W Revision	A.04.00

Reference Level Offset

Adds an offset value to the displayed reference level. The reference level is the absolute amplitude represented by the top graticule line on the display.

See “[Reference Level Offset](#)” on page 1404 under AMPTD Y Scale for more information.

Key Path	AMPTD Y Scale
Initial S/W Revision	A.04.00

μ W Path Control

The μ W Path Control functions include the μ W Preselector Bypass (Option MPB) and Low Noise Path (Option LNP) controls in the High Band path circuits.

See “ [\$\mu\$ W Path Control](#)” on page 1405 under AMPTD Y Scale for more information.

Key Path	AMPTD Y Scale
Initial S/W Revision	A.04.00

Internal Preamp

Accesses a menu of functions that enable you to control the internal preamplifiers.

See AMPTD Y Scale, “[Internal Preamp](#)” on page 1410 for more information.

Key Path	AMPTD Y Scale
Initial S/W Revision	Prior to A.02.00

Ref Position

Positions the reference level at the top, center, or bottom of the Y- scale display. Changing the reference position does not change the reference level value.

Key Path	AMPTD Y Scale
Mode	SA, WCDMA, C2K, WIMAX OFDMA, TD-SCDMA, 1xEVDO, DVB-T/H, DTMB (CTTB), ISDB-T, CMMB, LTE, LTETDD, Digital Cable TV, MSR
Remote Command	:DISPlay:ACPower:VIEW[1]:WINDow[1]:TRACe:Y[:SCALe]:RPOS ition TOP CENTer BOTTom :DISPlay:ACPower:VIEW[1]:WINDow[1]:TRACe:Y[:SCALe]:RPOS ition?
Example	DISP:ACP:VIEW:WIND:TRAC:Y:RPOS CENT DISP:ACP:VIEW:WIND:TRAC:Y:RPOS?
Notes	You must be in the mode that includes ACP measurements to use this command. Use :INSTrument:SELEct to set the mode.
Preset	TOP
State Saved	Saved in instrument state.
Range	Top Ctr Bot
Initial S/W Revision	Prior to A.02.00
Modified at S/W Revision	A.02.00, A.03.00

Auto Scaling

Toggles the Auto Scaling function between On and Off.

Key Path	AMPTD Y Scale
Mode	SA, WCDMA, C2K, WIMAX OFDMA, TD-SCDMA, 1xEVDO, DVB-T/H, DTMB (CTTB), ISDB-T, CMMB, LTE, LTETDD, Digital Cable TV, MSR
Remote Command	:DISPlay:ACPower:VIEW[1]:WINDow[1]:TRACe:Y[:SCALe]:COUP le 0 1 OFF ON :DISPlay:ACPower:VIEW[1]:WINDow[1]:TRACe:Y[:SCALe]:COUP le?
Example	DISP:ACP:VIEW:WIND:TRAC:Y:COUP ON DISP:ACP:VIEW:WIND:TRAC:Y:COUP?
Notes	You must be in the mode that includes ACP measurements to use this command. Use :INSTrument:SELEct to set the mode.

ACP Measurement
AMPTD Y Scale

Couplings	<p>When Auto Scaling is On and the Restart front-panel key is pressed, this function automatically determines the scale per division and reference values based on the measurement results.</p> <p>When you set a value to either Scale/Div or Ref Value manually, Auto Scaling automatically changes to Off.</p>
Preset	ON
State Saved	Saved in instrument state.
Range	On Off
Initial S/W Revision	Prior to A.02.00
Modified at S/W Revision	A.02.00, A.03.00

Auto Couple

See [“Auto Couple” on page 1412](#) in the section "Common Measurement Functions" for more information.

Key Path	Front-panel key
Initial S/W Revision	Prior to A.02.00

BW

Accesses a menu of functions that enable you to specify and control the video and resolution bandwidths. You can also select the type of filter for the measurement and set the filter bandwidth.

Key Path	Front-panel key
Initial S/W Revision	Prior to A.02.00

Res BW

Sets the value of the resolution bandwidth. If an unavailable bandwidth is entered with the numeric keypad, the closest available bandwidth is selected.

Key Path	BW
Mode	SA, WCDMA, C2K, WIMAX OFDMA, TD-SCDMA, 1xEVDO, DVB-T/H, DTMB (CTTB), ISDB-T, CMMB, LTE, LTETDD, Digital Cable TV, MSR
Remote Command	[:SENSe]:ACPower:BANDwidth[:RESolution] <bandwidth> [:SENSe]:ACPower:BANDwidth[:RESolution]? [:SENSe]:ACPower:BANDwidth[:RESolution]:AUTO ON OFF 1 0 [:SENSe]:ACPower:BANDwidth[:RESolution]:AUTO?
Example	ACP:BAND 25kHz ACP:BAND? ACP:BAND:AUTO ON ACP:BAND:AUTO?
Notes	This key is available only in IBW mode. This parameter is preset by the Meas Method selection. Preset values are as follows: IBW: 100 kHz IBWR: 27 kHz FAST (WCDMA): 390 kHz You must be in the mode that includes ACP measurements to use this command. Use :INSTrument:SELEct to set the mode.
Dependencies	When Meas Method is RBW or FAST, this key is grayed out and disabled. If the key is pressed, an advisory message is generated. If the equivalent remote command is sent, a "Setting conflict" warning is generated.
Couplings	The resolution bandwidth is coupled to the video bandwidth based on the video to resolution bandwidth ratio setting if AUTO is selected.

Preset	SA: 220 kHz WCDMA: 100 kHz WIMAX OFDMA: 100 kHz C2K: Method RBW: grayed out (1.2 MHz) Method IBW: 15 kHz TD-SCDMA: 30 kHz 1xEVDO: 30 kHz DVB-T/H: 39 kHz DTMB (CTTB): 39 kHz ISDB-T: 39 kHz CMMB: 39 kHz LTE: 100 kHz LTETDD: 100 kHz Digital Cable TV: 39 kHz MSR: 100 kHz 0
State Saved	Saved in instrument state.
Min	1 Hz
Max	8 MHz
Backwards Compatibility SCPI	[[:SENSe]:ACPower:BWIDth[:RESolution] [:SENSe]:ACP:SWEp:BANDwidth BWIDth[:RESolution] (PSA W-CDMA, PSA cdma2000)
Initial S/W Revision	Prior to A.02.00
Modified at S/W Revision	A.02.00, A.03.00

Video BW

Changes the analyzer post-detection filter (VBW).

Key Path	BW
Mode	SA, WCDMA, C2K, WIMAX OFDMA, TD-SCDMA, 1xEVDO, DVB-T/H, DTMB (CTTB), ISDB-T, CMMB, LTE, LTETDD, Digital Cable TV, MSR
Remote Command	[[:SENSe]:ACPower:BANDwidth:VIDeo <freq> [:SENSe]:ACPower:BANDwidth:VIDeo? [:SENSe]:ACPower:BANDwidth:VIDeo:AUTO OFF ON 0 1 [:SENSe]:ACPower:BANDwidth:VIDeo:AUTO?

ACP Measurement
BW

Example	ACP:BAND:VID 1kHz ACP:BAND:VID? ACP:BWID:VID:AUTO ON ACP:BWID:VID:AUTO?
Notes	The values shown in this table reflect the conditions after a Mode Preset.
Dependencies	When Meas Method is RBW or FAST, this key is grayed out and disabled. If the key is pressed, an advisory message is generated. If the equivalent remote command is sent, a "Setting conflict" warning is generated.
Preset	SA: 22 kHz WCDMA, WIMAX OFDMA: 1 MHz C2K: Method RBW: grayed out (1.2 MHz) Method IBW: 150 kHz TD-SCDMA: 300 kHz 1xEVDO: 300 kHz DVB-T/H: 390 kHz DTMB (CTTB): 390 kHz ISDB-T: 390 kHz CMMB: 390 kHz LTE, LTETDD, MSR: Auto LTETDD: 1 MHz Digital Cable TV: 390 kHz SA: ON WCDMA: OFF WIMAX OFDMA: OFF TD-SCDMA: OFF DVB-T/H: OFF DTMB (CTTB): OFF CDMA1xEVDO: OFF ISDB-T: OFF CMMB: OFF LTE, MSR: ON LTETDD: ON Digital Cable TV: OFF
State Saved	Saved in instrument state.

Min	1 Hz
Max	50 MHz
Backwards Compatibility SCPI	[:SENSe]:ACPower:BWIDth:VIDeo
Initial S/W Revision	Prior to A.02.00
Modified at S/W Revision	A.02.00, A.03.00

RBW Control

Accesses a menu that enables you to select the filter bandwidth and type.

Key Path	BW
Initial S/W Revision	Prior to A.02.00

Filter Type

Selects the type of bandwidth filter that is used. The choices are Gaussian or Flat top.

Key Path	BW, RBW Control
Mode	SA, WCDMA, C2K, WIMAX OFDMA, TD-SCDMA, 1xEVDO, DVB-T/H, DTMB (CTTB), ISDB-T, CMMB, LTE, LTETDD, Digital Cable TV, MSR
Remote Command	[:SENSe]:ACPower:BAWIDth:SHAPE GAUSSian FLATtop [:SENSe]:ACPower:BAWIDth:SHAPE?
Example	ACP:BAWIDth:SHAPE GAUS ACP:BAWIDth:SHAPE?
Dependencies	When Meas Method is FAST, this key is grayed out and disabled. If the key is pressed, an advisory message is generated. If the equivalent remote command is sent, a "Setting conflict" warning is generated.
Preset	GAUSSian C2K: FLATtop
State Saved	Saved in instrument state.
Range	Gaussian (Normal) Flattop
Backwards Compatibility SCPI	[:SENSe]:ACPower:BWIDth:SHAPE
Initial S/W Revision	Prior to A.02.00
Modified at S/W Revision	A.02.00, A.03.00

Filter BW

Selects a Gaussian filter based on its –3 dB (Normal) bandwidth or its –6 dB bandwidth.

Key Path	BW, RBW Control
Mode	SA, WCDMA, C2K, WIMAX OFDMA, TD-SCDMA, 1xEVDO, DVB-T/H, DTMB (CTTB), ISDB-T, CMMB, LTE, LTETDD, Digital Cable TV, MSR
Remote Command	[:SENSE] :ACPower :BANDwidth :TYPE DB3 DB6 [:SENSE] :ACPower :BANDwidth :TYPE?
Example	ACP:BAND:TYPE DB3 ACP:BAND:TYPE?
Dependencies	When Filter Type is Flattop or Meas Method is RBW or FAST, this key is grayed out and disabled. If the key is pressed, an advisory message is generated. If the equivalent remote command is sent, a "Setting conflict" warning is generated.
Preset	DB3
State Saved	Saved in instrument state.
Range	–3 dB (Normal) –6 dB
Backwards Compatibility SCPI	[:SENSE]:ACPower:BWIDth:TYPE
Initial S/W Revision	Prior to A.02.00
Modified at S/W Revision	A.02.00, A.03.00

Cont

See “[Cont \(Continuous Measurement/Sweep\)](#)” on page 1413 in the section "Common Measurement Functions" for more information.

Key Path	Front-panel key
Initial S/W Revision	Prior to A.02.00

FREQ Channel

See “[FREQ Channel](#)” on page 1414 for more information.

Key Path	Front-panel key
Initial S/W Revision	Prior to A.02.00

Input/Output

See [“Input/Output” on page 1422](#) for more information.

Key Path	Front-panel key
Initial S/W Revision	Prior to A.02.00

Marker

Accesses a menu that enables you to select, set up and control the markers for the current measurement. Note that this hard key and all sub keys are unavailable when “[Meas Method](#)” on page 534 is set to RBW.

Key Path	Front-panel key
Initial S/W Revision	Prior to A.02.00

Select Marker

Displays 12 markers available for selection. Note that this key is unavailable when “[Meas Method](#)” on page 534 is set to RBW.

Key Path	Marker
Initial S/W Revision	Prior to A.02.00

Marker Type

Sets the marker control mode to **Normal**, **Delta**, **Fixed** or **Off**. All interactions and dependencies detailed under the key description are enforced when the remote command is sent. If the selected marker is Off, pressing Marker sets it to Normal and places it at the center of the screen on the trace determined by the **Marker Trace** rules. At the same time, **Marker X Axis Value** appears on the Active Function area.

The default active function is the active function for the currently selected marker control mode. If the current control mode is Off, there is no active function and the active function is turned off.

Key Path	Marker
Mode	SA, WCDMA, C2K, WIMAX OFDMA, TD-SCDMA, 1xEVDO, DVB-T/H, DTMB (CTTB), ISDB-T, CMMB, LTE, LTETDD, Digital Cable TV, MSR
Remote Command	:CALCulate:ACPower:MARKer[1] 2 3 4 5 6 7 8 9 10 11 12:MODE POSition DELTA OFF :CALCulate:ACPower:MARKer[1] 2 3 4 5 6 7 8 9 10 11 12:MODE?
Example	CALC:ACP:MARK2:MODE DELT CALC:ACP:MARK2:MODE?

Notes	<p>If the selected marker is Off, pressing Marker sets it to Normal and places it at the center of the screen on the trace determined by the Marker Trace rules. At the same time, Marker X Axis Value appears on the Active Function area.</p> <p>Default Active Function: the active function for the selected marker's current control mode. If the current control mode is Off, there is no active function and the active function is turned off.</p> <p>Active Function Display: the marker X axis value entered in the active function area will display the marker value to its full entered precision.</p> <p>You must be in the mode that includes ACP measurements to use this command. Use :INSTrument:SElect to set the mode.</p>
Dependencies	This key is unavailable when “Meas Method” on page 534 is set to RBW.
Preset	OFF OFF OFF OFF OFF OFF OFF OFF OFF OFF OFF OFF
State Saved	Saved in instrument state.
Range	Normal Delta Off
Initial S/W Revision	Prior to A.02.00
Modified at S/W Revision	A.02.00, A.03.00

Marker X Axis Value (Remote Command only)

Sets the marker X axis value in the current marker X Axis Scale unit. This value has no effect if the control mode is **Off**, but is the SCPI equivalent of entering an X value if the control mode is **Normal**, **Delta** or **Fixed**.

Mode	SA, WCDMA, C2K, WIMAX OFDMA, TD-SCDMA, 1xEVDO, DVB-T/H, DTMB (CTTB), ISDB-T, CMMB, LTE, LTETDD, Digital Cable TV, MSR
Remote Command	<pre>:CALCulate:ACPower:MARKer[1] 2 3 4 5 6 7 8 9 10 11 12:X <freq></pre> <pre>:CALCulate:ACPower:MARKer[1] 2 3 4 5 6 7 8 9 10 11 12:X ?</pre>
Example	<pre>CALC:ACP:MARK3:X 0</pre> <pre>CALC:ACP:MARK3:X?</pre>
Notes	The query returns the marker's absolute X Axis value if the control mode is Normal , or the offset from the marker's reference marker if the control mode is Delta . If the marker is Off the response is not a number.
Dependencies	Unavailable when “Meas Method” on page 534 is set to RBW.
Preset	After a preset, all Markers are turned OFF, so Marker X Axis Value query will return a not a number (NAN).
State Saved	No
Min	-9.9E+37

ACP Measurement
Marker

Max	9.9E+37
Initial S/W Revision	Prior to A.02.00
Modified at S/W Revision	A.02.00, A.03.00

Marker X Axis Position (Remote Command only)

Sets the marker X position in trace points. It has no effect if the control mode is **Off**, but is the SCPI equivalent of entering a value if the control mode is **Normal**, **Delta** or **Fixed**. The entered value is immediately translated into the current X Axis Scale units for setting the value of the marker.

Mode	SA, WCDMA, C2K, WIMAX OFDMA, TD-SCDMA, 1xEVDO, DVB-T/H, DTMB (CTTB), ISDB-T, CMMB, LTE, LTETDD, Digital Cable TV, MSR
Remote Command	:CALCulate:ACPower:MARKer[1] 2 3 4 5 6 7 8 9 10 11 12:X :POSition <real> :CALCulate:ACPower:MARKer[1] 2 3 4 5 6 7 8 9 10 11 12:X :POSition?
Example	CALC:ACP:MARK10:X:POS 0 CALC:ACP:MARK10:X:POS?
Notes	The query returns the marker's absolute X Axis value in trace points if the control mode is Normal , or the offset from the marker's reference marker in trace points if the control mode is Delta . The value is returned as a real number, not an integer, corresponding to the translation from X Axis Scale units to trace points (see "Fractional Trace Points"). If the marker is Off the response is not a number. When a Marker is turned on, it is placed center of the screen on the trace. Therefore the default value depends on instrument condition, although the Preset/Default is defined as 500 (this value might be expected value when all offset is on).
Dependencies	Unavailable when " Meas Method " on page 534 is set to RBW.
Preset	After a preset, all Markers are turned OFF, so Marker X Axis Value query will return a not a number (NAN).
State Saved	No
Min	-9.9E+37
Max	9.9E+37
Initial S/W Revision	Prior to A.02.00
Modified at S/W Revision	A.02.00, A.03.00

Marker Y Axis Value (Remote Command only)

Returns the marker Y axis value in the current marker Y axis unit.

Mode	SA, WCDMA, C2K, WIMAX OFDMA, TD-SCDMA, 1xEVDO, DVB-T/H, DTMB (CTTB), ISDB-T, CMMB, LTE, LTETDD, Digital Cable TV, MSR
Remote Command	:CALCulate:ACPower:MARKer[1] 2 3 4 5 6 7 8 9 10 11 12:Y?
Example	CALC:ACP:MARK11:Y?
Notes	Since the result value is always calculated from acquisition data, the default value is arbitrary. Although the Preset/Default values are defined.
Dependencies	Unavailable when “ Meas Method ” on page 534 is set to RBW.
Preset	Result dependent on markers setup and signal source.
State Saved	No
Backwards Compatibility SCPI	:CALCulate:ACPower:MARKer[1] 2 3 4 5 6 7 8 9 10 11 12:FUNCTION:RESult?
Initial S/W Revision	Prior to A.02.00
Modified at S/W Revision	A.02.00, A.03.00

Properties

Accesses the marker properties menu. Note that this key is unavailable when “[Meas Method](#)” on page 534 is set to RBW.

Key Path	Marker
Initial S/W Revision	Prior to A.02.00

Select Marker

Displays 12 markers available for selection. Note that this key is unavailable when “[Meas Method](#)” on page 534 is set to RBW.

Key Path	Marker
Initial S/W Revision	Prior to A.02.00

Relative To

Selects the desired marker. The selected marker will be relative to its reference marker.

Key Path	Marker, Properties
Mode	SA, WCDMA, C2K, WIMAX OFDMA, TD-SCDMA, 1xEVDO, DVB-T/H, DTMB (CTTB), ISDB-T, CMMB, LTE, LTETDD, Digital Cable TV, MSR

ACP Measurement
Marker

Remote Command	:CALCulate:ACPower:MARKer[1] 2 3 4 5 6 7 8 9 10 11 12:REFerence <integer> :CALCulate:ACPower:MARKer[1] 2 3 4 5 6 7 8 9 10 11 12:REFerence?
Example	CALC:ACP:MARK2:REF 6 CALC:ACP:MARK2:REF?
Notes	A marker cannot be relative to itself so that choice is grayed out, and if sent from a remote command, generates error -221: "Settings conflict; marker cannot be relative to itself." When queried a single value will be returned (the specified marker numbers relative marker). You must be in the mode that includes ACP measurements to use this command. Use :INSTrument:SElect to set the mode.
Dependencies	This key is unavailable when " Meas Method " on page 534 is set to RBW.
Preset	2 3 4 5 6 7 8 9 10 11 12 1
State Saved	Saved in instrument state.
Min	1
Max	12
Initial S/W Revision	Prior to A.02.00
Modified at S/W Revision	A.02.00, A.03.00

Marker Trace

Selects the trace that you want your marker to be placed on. A marker is associated with one and only one trace. This trace is used to determine the placement, result, and X Axis Scale of the marker. All markers have an associated trace, even **Fixed** markers; it is from that trace that they determine their attributes and behaviors, and it is to that trace that they go when they become Normal or Delta markers.

Key Path	Marker, Properties
Mode	SA, WCDMA, C2K, WIMAX OFDMA, TD-SCDMA, 1xEVDO, DVB-T/H, DTMB (CTTB), ISDB-T, CMMB, LTE, LTETDD, Digital Cable TV, MSR
Remote Command	:CALCulate:ACPower:MARKer[1] 2 3 4 5 6 7 8 9 10 11 12:TRACe 1 2 3 :CALCulate:ACPower:MARKer[1] 2 3 4 5 6 7 8 9 10 11 12:TRACe?
Example	CALC:ACP:MARK2:TRAC 2 CALC:ACP:MARK2:TRAC?

Notes	<p>If the selected marker is Off, pressing Marker sets it to Normal and places it at the center of the screen on the trace determined by the Marker Trace rules. At the same time, Marker X Axis Value appears on the Active Function area.</p> <p>Default Active Function: the active function for the selected marker's current control mode. If the current control mode is Off, there is no active function and the active function is turned off.</p> <p>Active Function Display: the marker X axis value entered in the active function area will display the marker value to its full entered precision.</p>
Dependencies	This key is unavailable when " Meas Method " on page 534 is set to RBW.
Couplings	<p>This is not affected by Auto Coupling.</p> <p>Sending the remote command causes the addressed marker to become selected.</p>
Preset	All Markers Off
State Saved	Saved in instrument state.
Range	1 2 3
Initial S/W Revision	Prior to A.02.00
Modified at S/W Revision	A.02.00, A.03.00

Couple Markers

When this function is On, moving any marker causes an equal X axis movement of every other marker which is not **Off**. By "equal X axis movement" we mean that we preserve the difference between each marker's X axis value (in the fundamental x-axis units of the trace that marker is on) and the X axis value of the marker being moved (in the same fundamental x-axis units).

Key Path	Marker
Mode	SA, WCDMA, C2K, WIMAX OFDMA, TD-SCDMA, 1xEVDO, DVB-T/H, DTMB (CTTB), ISDB-T, CMMB, LTE, LTETDD, Digital Cable TV, MSR
Remote Command	:CALCulate:ACPower:MARKer:COUPle[:STATE] ON OFF 1 0 :CALCulate:ACPower:MARKer:COUPle[:STATE]?
Example	CALC:ACP:MARK:COUP ON
Dependencies	This key is unavailable when " Meas Method " on page 534 is set to RBW.
Preset	OFF
State Saved	Saved in instrument state.
Range	On Off
Initial S/W Revision	Prior to A.02.00
Modified at S/W Revision	A.02.00, A.03.00

Marker All Off

Turns all active markers off.

Key Path	Marker
Mode	SA, WCDMA, C2K, WIMAX OFDMA, TD-SCDMA, 1xEVDO, DVB-T/H, DTMB (CTTB), ISDB-T, CMMB, LTE, LTETDD, Digital Cable TV, MSR
Remote Command	:CALCulate:ACPpower:MARKer:AOff
Example	CALC:ACP:MARK:AOff
Dependencies	This key is unavailable when “ Meas Method ” on page 534 is set to RBW.
Initial S/W Revision	Prior to A.02.00
Modified at S/W Revision	A.02.00, A.03.00

Backward Compatibility Remote Commands

Sets or queries the state of a marker. Setting a marker which is off to the on state or 1 puts it in Normal mode and places it at the center of the screen.

Mode	SA, WCDMA, WIMAX OFDMA, C2K, TD-SCDMA, 1xEVDO, DVB-T/H, DTMB (CTTB), ISDB-T, CMMB, LTE, LTETDD, Digital Cable TV, MSR
Remote Command	:CALCulate:ACPpower:MARKer[1] 2 3 4 5 6 7 8 9 10 11 12:STATe OFF ON 0 1 :CALCulate:ACPpower:MARKer[1] 2 3 4 5 6 7 8 9 10 11 12:STATe?
Example	CALC:ACP:MARK2:STAT ON CALC:ACP:MARK2:STAT?
Notes	This parameter is also accessed from Marker, Properties, 1 You must be in the mode that includes ACP measurements to use this command. Use :INSTrument:SELEct to set the mode.
Preset	OFF OFF OFF OFF OFF OFF OFF OFF OFF OFF OFF OFF
State Saved	Saved in instrument state.
Range	On Off
Initial S/W Revision	Prior to A.02.00
Modified at S/W Revision	A.02.00, A.03.00

Marker Function

There are no Marker Functions supported in the ACP measurement. The front-panel key will display a blank key menu when pressed.

Key Path	Front-panel key
Initial S/W Revision	Prior to A.02.00

Marker To

There is no Marker To functionality supported in ACP. The front-panel key will display a blank key menu when pressed.

Key Path	Front-panel key
Initial S/W Revision	Prior to A.02.00

Meas

See “Meas” on page 1520 for more information.

Key Path	Front-panel key
Initial S/W Revision	Prior to A.02.00

Meas Setup

Displays the setup menu for the currently selected measurement. The functions included in the measurement setup menu include setting the parameters for the carriers, offsets, bandwidths, measurement methods and types. This menu also allows you to turn noise correction on and off.

Key Path	Front-panel key
Initial S/W Revision	Prior to A.02.00

Average/Hold Number

Specifies the number of measurement averages used to calculate the measurement result. The average will be displayed at the end of each sweep. After the specified number of average counts, the average mode (termination control) setting determines the average action.

Key Path	Meas Setup
Mode	SA, WCDMA, C2K, WIMAX OFDMA, TD-SCDMA, 1xEVDO, DVB-T/H, DTMB (CTTB), ISDB-T, CMMB, LTE, LTETDD, Digital Cable TV, MSR
Remote Command	[:SENSe]:ACPpower:AVERage:COUNT <integer> [:SENSe]:ACPpower:AVERage:COUNT? [:SENSe]:ACPpower:AVERage[:STATe] OFF ON 0 1 [:SENSe]:ACPpower:AVERage[:STATe]?
Example	ACP:AVER:COUN 250 ACP:AVER:COUN? ACP:AVER OFF ACP:AVER?
Notes	You must be in the mode that includes ACP measurements to use this command. Use :INSTrument:SELEct to set the mode.
Preset	10 ON
State Saved	Saved in instrument state.
Min	1
Max	1000
Backwards Compatibility SCPI	[:SENSe]:ACPR:AVERage:COUNT [:SENSe]:MCPower:AVERage:COUNT (PSA Power Suite, PSA W-CDMA, PSA cdma2000)
Initial S/W Revision	Prior to A.02.00

Modified at S/W Revision	A.02.00, A.03.00
--------------------------	------------------

Avg Mode

Enables you to set the averaging mode. This determines the averaging action after the specified number of data acquisitions (average count) is reached.

When set to Exponential (Exp) the measurement averaging continues using the specified number of averages to compute each averaged value. The average will be displayed at the end of each sweep.

When set to Repeat, the measurement resets the average counter each time the specified number of averages is reached.

Key Path	Meas Setup
Mode	SA, WCDMA, C2K, WIMAX OFDMA, TD-SCDMA, 1xEVDO, DVB-T/H, DTMB (CTTB), ISDB-T, CMMB, LTE, LTETDD, Digital Cable TV, MSR
Remote Command	[:SENSe] :ACPower :AVERage :TCONtrol EXPonential REPEAT [:SENSe] :ACPower :AVERage :TCONtrol?
Example	ACP:AVER:TCON EXP ACP:AVER:TCON?
Notes	You must be in the mode that includes ACP measurements to use this command. Use :INSTrument:SElect to set the mode.
Preset	EXponential
State Saved	Saved in instrument state.
Range	Exp Repeat
Backwards Compatibility SCPI	[:SENSe] :ACPR :AVERage :TCONtrol
Initial S/W Revision	Prior to A.02.00
Modified at S/W Revision	A.02.00, A.03.00

Carrier Setup (This menu is unavailable in MSR)

Accesses a menu that contains Carriers, Ref Carrier, Ref Car Freq, Ref Car Pwr and Configure Carriers.

Key Path	Meas Setup
Initial S/W Revision	Prior to A.02.00

Carriers

Specifies the number of carriers to be measured.

Key Path	Meas Setup, Carrier Setup, Configure Carriers
----------	---

ACP Measurement
Meas Setup

Mode	SA, WCDMA, C2K, WIMAX OFDMA, 1xEVDO, TD-SCDMA, DVB-T/H, DTMB (CTTB), ISDB-T, CMMB, LTE, LTETDD, Digital Cable TV
Remote Command	[:SENSe]:ACPower:CARRier[1] 2:COUNT <integer> [:SENSe]:ACPower:CARRier[1] 2:COUNT?
Example	ACP:CARR:COUN 1 ACP:CARR:COUN?
Notes	Carrier sub op code. 1 for BTS, 2 for MS. Default is BTS. Note that Carrier sub op code 2 is supported only in Non-SA modes. In the SA mode, Carrier sub op code 1 is used for both BTS and MS. You must be in the mode that includes ACP measurements to use this command. Use :INSTrument:SELEct to set the mode.
Dependencies	When Number of Carriers is 1, Ref Carrier is grayed out. If N9060A-5FP license is enabled, Max of Carrier is 18, otherwise, Max of Carrier is 12.
Couplings	Changing this parameter might affect to the Span. .
Preset	1
State Saved	Saved in instrument state.
Min	1
Max	Refer to Dependencics item.
Initial S/W Revision	Prior to A.02.00
Modified at S/W Revision	A.02.00, A.03.00

Ref Carrier

Sets the reference carrier. Relative power measurements are made from the reference carrier.

If set to Auto, the measurement selects the carrier with the highest power as the reference carrier and the Ref Carrier parameter is updated. If a value is entered when Ref Carrier Mode is set to Auto, the mode changes to Man.

If set to Man, the value that you enter for the Ref Carrier is used as the reference carrier.

Key Path	Meas Setup, Carrier Setup
Mode	SA, WCDMA, C2K, WIMAX OFDMA, 1xEVDO, TD-SCDMA, DVB-T/H, DTMB (CTTB), ISDB-T, CMMB, LTE, LTETDD, Digital Cable TV
Remote Command	[:SENSe]:ACPower:CARRier[1] 2:RCARrier <integer> [:SENSe]:ACPower:CARRier[1] 2:RCARrier? [:SENSe]:ACPower:CARRier[1] 2:RCARrier:AUTO OFF ON 0 1 [:SENSe]:ACPower:CARRier[1] 2:RCARrier:AUTO?

Example	ACP:CARR:RCAR 1 ACP:CARR:RCAR? ACP:CARR:RCAR:AUTO OFF ACP:CARR:RCAR:AUTO?
Notes	Carrier sub op code. 1 for BTS, 2 for MS. Default is BTS. Note that Carrier sub op code 2 is supported only in Non-SA modes. In the SA mode, Carrier sub op code 1 is used for both BTS and MS. You must be in the mode that includes ACP measurements to use this command. Use :INSTrument:SElect to set the mode.
Dependencies	If there is only one carrier, this key will be grayed out.
Couplings	If you enter a carrier value that is currently configured as having no power present, that carrier will be changed to having power present. If you enter a ref carrier this parameter will be set to manual.
Preset	Auto determined
State Saved	Saved in instrument state.
Min	1
Max	Number of available carriers
Backwards Compatibility SCPI	[:SENSe]:MCPower:RCARrier[1] 2 (PSA Power Suite)
Initial S/W Revision	Prior to A.02.00
Modified at S/W Revision	A.02.00, A.03.00

Ref Car Freq

Sets the reference carrier frequency.

Key Path	Meas Setup, Carrier Setup
Mode	SA, WCDMA, C2K, WIMAX OFDMA, 1xEVDO, TD-SCDMA, DVB-T/H, DTMB (CTTB), ISDB-T, CMMB, LTE, LTETDD, Digital Cable TV
Remote Command	[:SENSe]:ACPpower:CARRier[1] 2:RCFRrequency <freq> [:SENSe]:ACPpower:CARRier[1] 2:RCFRrequency? [:SENSe]:ACPpower:CARRier[1] 2:RCFRrequency:AUTO OFF ON 0 1 [:SENSe]:ACPpower:CARRier[1] 2:RCFRrequency:AUTO?
Example	ACP:CARR:RCFR 250 MHz ACP:CARR:RCFR? ACP:CARR:RCFR:AUTO OFF ACP:CARR:RCFR:AUTO?

ACP Measurement
Meas Setup

Notes	<p>Carrier sub op code. 1 for BTS, 2 for MS. Default is BTS.</p> <p>Note that Carrier sub op code 2 is supported only in Non-SA modes.</p> <p>In the SA mode, Carrier sub op code 1 is used for both BTS and MS.</p> <p>You must be in the mode that includes ACP measurements to use this command. Use :INSTrument:SELEct to set the mode.</p>
Couplings	<p>Coupled to the Center Frequency.</p> <p>If the center frequency changes, the Ref Carrier Frequency is calculated using the following three steps;</p> <p>Ref Freq1 = Ctr Freq - (Total of all Carrier Widths / 2)</p> <p>Ref Freq2 = Ref Freq1 + (Total of all Carrier Widths up to Ref Carrier)</p> <p>Ref Freq = Ref Freq2 + (0.5 * Carrier Width of Ref Carrier)</p> <p>If reference carrier frequency changes the Center Frequency is calculated using the following three steps;</p> <p>Ctr Freq1 = Ref Freq - (0.5 * Carrier Width of Ref Carrier)</p> <p>Ctr Freq2 = Ctr Freq1 - (Total of all Carrier Widths up to Ref Carrier)</p> <p>Ctr Freq = Ctr Freq2 + (Total of all Carrier Widths / 2)</p> <p>This ensures that the carriers are always centered on the screen.</p> <p>If there is only one carrier present the Reference Carrier Frequency will be the same as the Center Frequency.</p>
Preset	Calculated based on the current Center Frequency
State Saved	Saved in instrument state.
Min	-79.999995 MHz
Max	<p>Hardware Dependent:</p> <p>Option 503 = 3.699999995 GHz</p> <p>Option 508 = 8.499999995 GHz</p> <p>Option 513 = 13.799999995 GHz</p> <p>Option 526 = 26.999999995 GHz</p>
Initial S/W Revision	Prior to A.02.00
Modified at S/W Revision	A.02.00, A.03.00

Power Ref

Sets the power reference in the carrier that will be used to compute the relative values for the offsets.

Key Path	Meas Setup, Carrier Setup
Initial S/W Revision	Prior to A.02.00
Modified at S/W Revision	A.03.00, A.04.00

Total Power

Sets the multi-carrier power reference.

When set to Auto, the carrier power result reflects the measured power value in the selected reference carrier.

When set to Man, the result is referenced to the last measured value, or you may specify the reference for the multi-carrier power measurement. Relative values are displayed, referenced to the “Power Reference” value.

Key Path	Meas Setup, Carrier Setup, Power Ref
Mode	SA, WCDMA, C2K, WIMAX OFDMA, TD-SCDMA, DVB-T/H, DTMB (CTTB), ISDB-T, CMMB, LTE, LTETDD, Digital Cable TV, MSR
Remote Command	[:SENSE]:ACPpower:CARRier[1] 2[:POWER] <real> [:SENSE]:ACPpower:CARRier[1] 2[:POWER]? [:SENSE]:ACPpower:CARRier[1] 2:AUTO[:STATE] OFF ON 0 1 [:SENSE]:ACPpower:CARRier[1] 2:AUTO[:STATE]?
Example	ACP:CARR 10 ACP:CARR? ACP:CARR:AUTO OFF ACP:CARR:AUTO?
Notes	Although the default value is defined, the value is recalculated by the measurement result just after measurement. Carrier sub op code: 1 for BTS, 2 for MS. Default is BTS. Carrier sub op code 2 is supported only in Non-SA modes. MS is not supported in MSR. In the SA mode, Carrier sub op code 1 is used for both BTS and MS. The Unit Terminator keys differ depending on whether or not the mode supports Y Axis Unit and also which Y Axis Unit is selected. For details, see “Y Axis Unit” on page 1399 . You must be in the mode that includes ACP measurements to use this command. Use :INSTRument:SElect to set the mode. Power Ref State ([:SENSe]:ACPpower:CARRier[1] 2:AUTO[:STATE]) is not available in MSR mode.
Dependencies	This key is available only when the Meas Type is TPRef. If the Meas Type is not TPRef, this key is grayed out.
Preset	0.0 ON
State Saved	Saved in instrument state.
Min	-200 dBm

ACP Measurement
Meas Setup

Max	200 dBm
Backwards Compatibility SCPI	[:SENSe]:MCPower:CARRier[1] 2[:POWER]
Initial S/W Revision	Prior to A.02.00
Modified at S/W Revision	A.02.00, A.03.00, A.04.00, A.10.00

PSD

Sets the power spectral density in the carrier (main channel) that is used to compute the relative power spectral density values for the offsets when Meas Type is set to PSD Ref. When the PSD Ref state is set to Auto, this will be set to the measured carrier power spectral density.

Key Path	Meas Setup, Carrier Setup, Power Ref
Mode	SA, WCDMA, C2K, WIMAX OFDMA, TD-SCDMA, DVB-T/H, DTMB (CTTB), ISDB-T, CMMB, LTE, LTETDD, Digital Cable TV, MSR
Remote Command	[:SENSe]:ACPpower:CARRier[1] 2:CPSD <real> [:SENSe]:ACPpower:CARRier[1] 2:CPSD?
Example	ACP:CARR:CPSD 25 ACP:CARR:CPSD?
Notes	Although the default value is defined, the value is recalculated by the measurement result just after measurement. Carrier sub op code. 1 for BTS, 2 for MS. Default is BTS. MS is not supported in MSR. Note that Carrier sub op code 2 is supported only in Non-SA modes. In the SA mode, Carrier sub op code 1 is used for both BTS and MS. You must be in the mode that includes ACP measurements to use this command. Use :INSTrument:SELEct to set the mode.
Dependencies	This key is available only when the Meas Type is PSDRef. If the Meas Type is not PSDRef, this key is grayed out.
Couplings	The value of PSD is automatically converted when PSD Unit is changed.
Preset	0.0
State Saved	Saved in instrument state.
Min	-999
Max	999
Initial S/W Revision	Prior to A.02.00
Modified at S/W Revision	A.02.00, A.03.00, A.04.00, A.10.00

Configure Carriers

Accesses a menu that contains Carrier, Carrier Pwr Present, Carrier Width and Carrier Integ BW

parameters.

Key Path	Meas Setup, Carrier Setup
Initial S/W Revision	Prior to A.02.00

Carrier

Selects the carrier to configure for the current measurement.

Key Path	Meas Setup, Carrier Setup, Configure Carriers
Mode	SA, WCDMA, C2K, WIMAX OFDMA, 1xEVDO, TD-SCDMA, DVB-T/H, DTMB (CTTB), ISDB-T, CMMB, LTE, LTETDD, Digital Cable TV
Couplings	Max value is the number of available carriers, so this value might change when the number of carriers is changed.
Preset	1
State Saved	No
Min	1
Max	Number of available carriers
Initial S/W Revision	Prior to A.02.00
Modified at S/W Revision	A.02.00, A.03.00

Carrier Coupling

Couples carrier settings to carrier #1. The coupled parameters are Carrier Power Present, Carrier Spacing, Measurement Noise Bandwidth, Method, and Filter Alpha.

Key Path	Meas Setup, Carrier Setup, Configure Carriers
Mode	SA, WCDMA, C2K, WIMAX OFDMA, 1xEVDO, TD-SCDMA, DVB-T/H, DTMB (CTTB), ISDB-T, CMMB, LTE, LTETDD, Digital Cable TV
Remote Command	[:SENSe]:ACPower:CARRier[1] 2:LIST:COUPle OFF ON 0 1, OFF ON 0 1, OFF ON 0 1, OFF ON 0 1, OFF ON 0 1, OFF ON 0 1 [:SENSe]:ACPower:CARRier[1] 2:LIST:COUPle?
Example	ACP:CARR:LIST:COUP OFF ACP:CARR:LIST:COUP?
Notes	Carrier sub op code. 1 for BTS, 2 for MS. Default is BTS. Note that Carrier sub op code 2 is supported only in Non-SA modes. In the SA mode, Carrier sub op code 1 is used for both BTS and MS. You must be in the mode that includes ACP measurements to use this command. Use :INSTrument:SELEct to set the mode.

ACP Measurement
Meas Setup

Couplings	<p>When Couple is selected, the carrier settings are coupled to carrier #1. Coupled parameters are Carrier Power Present, Carrier Spacing, Measurement Noise Bandwidth, Method and Filter Alpha.</p> <p>When a setting is changed, the couple is set to Man automatically.</p> <p>Carrier #1 is always set to couple and cannot be changed.</p> <p>Couple/Man selection on the Carrier key is not displayed when selected carrier number is #1.</p>
Preset	ON
State Saved	Saved in instrument state.
Range	Couple Man
Initial S/W Revision	Prior to A.02.00
Modified at S/W Revision	A.02.00, A.03.00

Carrier Pwr Present

Configures the carriers for this measurement. It allows spaces to be inserted between carriers. Carriers with the power present parameter set to Yes are carriers, and those with the power present parameter set to No are spaces. Each carrier power present is set to Yes or No. The individual carriers can be set by selecting the desired carrier on the carrier menu key using the up down arrows, the knob, or numeric keypad, then toggling the carrier power present using the carrier power present menu key.

The query for this parameter returns the current values for all of the carriers. If a carrier is defined as having no power present, the power displayed will be relative to the reference carrier, otherwise the absolute power will be displayed.

If you change the carrier power present to no and that carrier is currently configured as the reference carrier, the next carrier to the left (or the right if there are no carriers to the left) will be assigned as the reference carrier. This also applies to the scenario where there are only two carriers configured as having power present and you configure only one carrier to have no power present.

Key Path	Meas Setup, Carrier Setup, Configure Carriers
Mode	SA, WCDMA, C2K, WIMAX OFDMA, 1xEVDO, TD-SCDMA, DVB-T/H, DTMB (CTTB), ISDB-T, CMMB, LTE, LTETDD, Digital Cable TV
Remote Command	<pre>[:SENSe]:ACPpower:CARRier[1] 2:LIST:PPresent YES NO, YES NO, YES NO, YES NO, YES NO, YES NO [:SENSe]:ACPpower:CARRier[1] 2:LIST:PPresent?</pre>
Example	<pre>ACP:CARR2:LIST:PPR YES ACP:CARR2:LIST:PPR?</pre>

Notes	Carrier sub op code. 1 for BTS, 2 for MS. Default is BTS. Note that Carrier sub op code 2 is supported only in Non-SA modes. In the SA mode, Carrier sub op code 1 is used for both BTS and MS. When setting these values remotely, the position in the list sent corresponds to the carrier. Missing values are not permitted, therefore if you want to change values 2 and 6 you must send all values up to 6. Subsequent values will remain unchanged, unless the number of values sent is greater than the number of carriers, then subsequent values will be ignored.
Dependencies	If there is only one carrier, this key will be grayed out.
Couplings	Coupled to the number of carriers. When the SCPI command is sent, the number of carriers will be set to the number of entries in the parameter list.
Preset	YES
State Saved	Saved in instrument state.
Range	Yes No
Backwards Compatibility SCPI	[:SENSe]:MCPower:CARRier[1] 2:LIST:PPResent (PSA Power Suite)
Initial S/W Revision	Prior to A.02.00
Modified at S/W Revision	A.02.00, A.03.00

Carrier Spacing

Sets the width of the carrier spacing. This will be the value applied to all the current slots, whether they are carriers or spaces.

Enter each carrier spacing value individually by selecting the desired carrier on the carrier menu key using the up down arrows, the knob, or the numeric keypad, then enter the carrier width using the carrier spacing menu key.

Key Path	Meas Setup, Carrier Setup, Configure Carriers
Mode	SA, WCDMA, C2K, WIMAX OFDMA, 1xEVDO, TD-SCDMA, DVB-T/H, DTMB (CTTB), ISDB-T, CMMB, LTE, LTETDD, Digital Cable TV
Remote Command	[:SENSe]:ACPpower:CARRier[1] 2:LIST:WIDTh <bandwidth>, <bandwidth>, <bandwidth>, <bandwidth>, <bandwidth> [:SENSe]:ACPpower:CARRier[1] 2:LIST:WIDTh?
Example	ACP:CARR2:LIST:WIDT 25kHz ACP:CARR2:LIST:WIDT?

ACP Measurement
Meas Setup

Notes	<p>Carrier sub op code. 1 for BTS, 2 for MS. Default is BTS.</p> <p>Note that Carrier sub op code 2 is supported only in Non-SA modes.</p> <p>In the SA mode, Carrier sub op code 1 is used for both BTS and MS.</p> <p>When setting these values remotely, the position in the list sent corresponds to the carrier. Missing values are not permitted, therefore if you want to change values 2 and 6 you must send all values up to 6. Subsequent values will remain unchanged, unless the number of values sent is greater than the number of carriers, then subsequent values will be ignored.</p> <p>You must be in the mode that includes ACP measurements to use this command. Use :INSTrument:SELEct to set the mode.</p>
Couplings	<p>Coupled to the number of carriers. When the SCPI command is sent, the number of carriers will be set to the number of entries in the parameter list.</p> <p>Changing Carrier Spacing might affect the Span.</p>
Preset	<p>SA, WCDMA: 5 MHz</p> <p>WIMAX OFDMA: 10 MHz</p> <p>C2K: 1.25 MHz</p> <p>1xEVDO: 1.25 MHz</p> <p>TD-SCDMA: 1.6 MHz</p> <p>DVB-T/H: 8 MHz</p> <p>DTMB (CTTB): 8 MHz</p> <p>ISDB-T: 6 MHz</p> <p>CMMB: 8 MHz</p> <p>LTE: 5 MHz</p> <p>LTETDD: 5 MHz</p> <p>Digital Cable TV: 8 MHz</p>
State Saved	Saved in instrument state.
Min	0 Hz
Max	1 GHz
Backwards Compatibility SCPI	[:SENSE]:MCPower:CARRier[1]2:LIST:WIDTh (PSA Power Suite)
Initial S/W Revision	Prior to A.02.00
Modified at S/W Revision	A.02.00, A.03.00

Measurement Noise Bandwidth

Specifies the Measurement Noise Bandwidth used to calculate the power in the carriers.

Each Measurement Noise Bandwidth value is entered individually by selecting the desired carrier on the carrier menu key using the up down arrows, the knob, or the numeric keypad. Then enter the

measurement noise bandwidth using the measurement noise bandwidth key.

Key Path	Meas Setup, Carrier Setup, Configure Carriers
Mode	SA, WCDMA, C2K, WIMAX OFDMA, TD-SCDMA, 1xEVDO, DVB-T/H, DTMB (CTTB), ISDB-T, CMMB, LTE, LTETDD, Digital Cable TV
Remote Command	[:SENSE]:ACPpower:CARRIER[1] 2:LIST:BANDwidth[:INTEGRATION] <freq>, <freq>, <freq>, <freq>, <freq>, <freq> [:SENSE]:ACPpower:CARRIER[1] 2:LIST:BANDwidth[:INTEGRATION]?
Example	ACP:CARR2:LIST:BAND 25kHz ACP:CARR2:LIST:BAND?
Notes	In the WCDMA mode, the preset/default value is defined as 3.84 MHz. But internally, 4.6848 MHz is used as the default value. Carrier sub op code. 1 for BTS, 2 for MS. Default is BTS. Note that Carrier sub op code 2 is supported only in Non-SA modes. In the SA mode, Carrier sub op code 1 is used for both BTS and MS. When setting these values remotely, the position in the list sent corresponds to the carrier. Missing values are not permitted, therefore if you want to change values 2 and 6 you must send all values up to 6. Subsequent values will remain unchanged, unless the number of values sent is greater than the number of carriers, then subsequent values will be ignored. You must be in the mode that includes ACP measurements to use this command. Use :INSTRUMENT:SELEct to set the mode.
Couplings	Coupled to the number of carriers. When the SCPI command is sent, the number of carriers is set to the number of entries in the parameter list.
Preset	SA: 2 MHz WCDMA: 3.84 MHz WIMAX OFDMA: 10 MHz C2K: 1.23MHz TD-SCDMA: 1.28 MHz 1xEVDO: 1.23 MHz DVB-T/H: 7.61 MHz DTMB (CTTB): 7.56 MHz ISDB-T: 5.6 MHz CMMB: 7.512 MHz LTE, LTETDD: 4.515 MHz 4.5 MHz Digital Cable TV: 8.0 MHz
State Saved	Saved in instrument state.

ACP Measurement
Meas Setup

Min	10 Hz
Max	1 GHz
Backwards Compatibility SCPI	[:SENSe]:ACPower:BANDwidth:INTEgration [:SENSe]:ACPower:BWIDth:INTEgration [:SENSe]:ACPower:CARRier[1] 2:LIST:BWIDth[:INTEgration] [:SENSe]:MCPower:CARRier[1] 2:LIST:BANDwidth[:INTEgration] (PSA Power Suite) [:SENSe]:MCPower:CARRier[1] 2:LIST:BWIDth[:INTEgration] (PSA Power Suite)
Initial S/W Revision	Prior to A.02.00
Modified at S/W Revision	A.02.00, A.03.00

Method for Carrier

Accesses the carrier configuration method settings.

Key Path	Meas Setup, Carrier Setup, Configure Carriers
Mode	SA, WCDMA, WIMAX OFDMA, TD-SCDMA, DVB-T/H, DTMB (CTTB), ISDB-T, CMMB, LTE, LTETDD, Digital Cable TV
Remote Command	[:SENSe]:ACPower:CARRier[1] 2:LIST:FILTer[:RRC][:STATe] ON OFF 1 0, ON OFF 1 0, ON OFF 1 0, ON OFF 1 0, ON OFF 1 0, ON OFF 1 0 [:SENSe]:ACPower:CARRier[1] 2:LIST:FILTer[:RRC][:STATe] ?
Example	ACP:CARR:LIST:FILT 0,0,0,0 ACP:CARR:LIST:FILT?
Notes	The binary values translate as follows: 1 ON = RRC Weighted 0 OFF = Integ BW Maximum of Array length depends on the number of carriers. You must be in the mode that includes ACP measurements to use this command. Use :INSTrument:SELEct to set the mode.

Preset	SA, LTE, LTETDD: OFF WCDMA: ON WIMAX OFDMA: OFF TD-SCDMA: ON DVB-T/H: OFF DTMB (CTTB): ON ISDB-T, CMMB: OFF Digital Cable TV: OFF
State Saved	Saved in instrument state.
Range	IntegBW RRC Weight
Initial S/W Revision	Prior to A.02.00
Modified at S/W Revision	A.02.00, A.03.00

Filter Alpha for Carrier

Inputs the alpha value for the filter used in the current carrier configuration.

Key Path	Meas Setup, Carrier Setup, Configure Carriers, Method, RRC Weighted
Mode	SA, WCDMA, WIMAX OFDMA, TD-SCDMA, DVB-T/H, DTMB (CTTB), ISDB-T, CMMB, LTE, LTETDD, Digital Cable TV
Remote Command	[:SENSe]:ACPpower:CARRier[1] 2:LIST:FILTer:ALPHa <real>, <real>, <real>, <real>, <real> [:SENSe]:ACPpower:CARRier[1] 2:LIST:FILTer:ALPHa?
Example	ACP:CARR2:LIST:FILT:ALPH 0.5 ACP:CARR2:LIST:FILT:ALPH?
Notes	You must be in the mode that includes ACP measurements to use this command. Use :INSTrument:SElect to set the mode.
Preset	0.22 C2K: No DTMB (CTTB): 0.05 Digital Cable TV: 0.15
State Saved	Saved in instrument state.
Min	0.01
Max	1.0
Initial S/W Revision	Prior to A.02.00
Modified at S/W Revision	A.02.00, A.03.00

Power Ref (MSR Only)

Selects the power reference type.

Left & Right Carriers - Powers of leftmost and rightmost carriers with Measure Carrier On are the references of left and right sides respectively. Left and right carriers are determined based on the carrier center frequencies. If Measur Carriers of all the carriers are off, the reference power and all the relative power results are NaN. Relative limits are not evaluated.

Max Power Carrier - Maximum carrier power among the carriers of Measure Carrier On is the reference of measurement. If Measur Carriers of all the carriers are off, the reference power and all the relative power results are NaN. Relative limits are not evaluated.

Carrier Index - Power of the specified carrier is the reference of measurement. If Measur Carriers of this carrier index is off, the reference power and all the relative power results are NaN. Relative limits are not evaluated.

Manual - Power or PSD specified by the user is the reference of measurement.

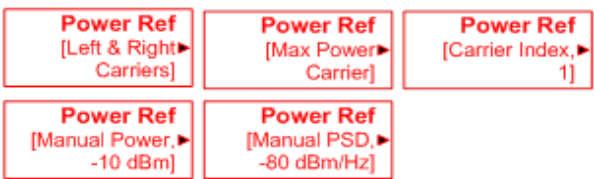
Key Path	Meas Setup
Mode	MSR
Remote Command	[:SENSe] :ACPower :CARRier :PREFereNce :TYPE LRCarriers MPCarrier CINDEX MANual [:SENSe] :ACPower :CARRier :PREFereNce :TYPE?
Example	ACP:CARR:PREF:TYPE CIND ACP:CARR:PREF:TYPE?
Notes	This command is available only in MSR. You must be in the MSR mode.
Preset	MPCarrier
State Saved	Saved in instrument state
Range	Left & Right Carriers Max Power Carriers Carrier Index Manual
Readback	Indirect readback as below: 
Initial S/W Revision	A.10.00

Carrier Index

Sets carrier index of the reference power. The power of the carrier selected by this index becomes reference power when Power Ref is Carrier Index.

Any value up to the MAX can be set though the measurement only deals with number of carriers specified by Carrier. If the index is larger than Carrier, reference power in this measurement becomes NaN and therefore all relative power results are NaN.

Key Path	Meas Setup, Power Ref
Mode	MSR
Remote Command	[:SENSe]:ACPower:CARRier:INDex <integer> [:SENSe]:ACPower:CARRier:INDex?
Example	ACP:CARR:IND 1 ACP:CARR:IND?
Notes	This command is available only in MSR. You must be in the MSR mode.
Preset	1
State Saved	Saved in instrument state
Min	1
Max	100
Initial S/W Revision	A.10.00

Manual

Accesses a menu that sets the manual reference power that is used to compute the relative values for the offsets.

Key Path	Meas Setup, Power Ref
Initial S/W Revision	A.10.00

Total Power

Sets manual total power reference. This is used when Power Ref is Manual and Meas Type is Total Power.

See [“Total Power” on page 499](#) for more information.

Key Path	Meas Setup, Power Ref, Manual
Initial S/W Revision	A.10.00

PSD

Sets manual PSD reference. This is used when Power Ref is Manual and Meas Type is PSD.

ACP Measurement
Meas Setup

See “PSD” on page 500 for more information.

Key Path	Meas Setup, Power Ref, Manual
Initial S/W Revision	A.10.00

Offset/Limits

Accesses a menu of functions that contains Offset, Offset Freq/Offset To Edge, Offset Integ BW, Upper Offset Limit and Lower Offset parameters.

Key Path	Meas Setup
Initial S/W Revision	Prior to A.02.00

Select Offset

Selects the offset to configure.

Key Path	Meas Setup, Offset/Limits, Limits
Mode	SA, WCDMA, C2K, WIMAX OFDMA, TD-SCDMA, 1xEVDO, DVB-T/H, DTMB (CTTB), ISDB-T, CMMB, LTE, LTETDD, Digital Cable TV, MSR
Preset	A
State Saved	Saved in instrument state.
Range	Offset A Offset B Offset C Offset D Offset E Offset F
Initial S/W Revision	Prior to A.02.00
Modified at S/W Revision	A.02.00, A.03.00

Offset Freq

This parameter determines the frequency difference between the center of the main channel and the center of the carrier.

Each Offset Freq state value is entered individually by selecting the desired carrier on the carrier menu key using the up down arrows, RPG or numeric keypad. Then enter the Offset Freq State using the Offset Frequency key.

The list contains up to six (6) entries, depending on the mode selected, for offset frequencies. Each offset frequency in the list corresponds to a reference bandwidth in the bandwidth list.

An offset frequency of zero turns the display of the measurement for that offset off, but the measurement is still made and reported. You can turn off (not use) specific offsets with the [:SENSE]:ACP:OFFSet:LIST:STAtE command

Turning the offset off has the same effect as setting the frequency of the offset to 0 Hz and will cause it to be removed from the results screen.

Key Path	Meas Setup, Offset/Limits
----------	----------------------------------

Mode	SA, WCDMA, C2K, WIMAX OFDMA, TD-SCDMA, 1xEVDO, DVB-T/H, DTMB (CTTB), ISDB-T, CMMB, LTE, LTETDD, Digital Cable TV, MSR
Remote Command	<pre>[:SENSe]:ACPower:OFFSet[1] 2:LIST[:FREQuency] <freq>, <freq>, <freq>, <freq>, <freq> [:SENSe]:ACPower:OFFSet[1] 2:LIST[:FREQuency]? [:SENSe]:ACPower:OFFSet[1] 2:LIST:STATe OFF ON 0 1, OFF ON 0 1, OFF ON 0 1, OFF ON 0 1, OFF ON 0 1, OFF ON 0 1 [:SENSe]:ACPower:OFFSet[1] 2:LIST:STATe?</pre>
Example	<pre>ACP:OFFS1:LIST 0,0,0,0,0 ACP:OFFS1:LIST? ACP:OFFS2:LIST:STAT 1,1,0,0,0 ACP:OFFS2:LIST:STAT?</pre>
Notes	<p>The label for this menu key will change depending on the currently selected radio standard or mode. For cdma2000 the label for the menu key will be Offset to Edge. For all other supported standards the label will be Offset Freq.</p> <p>When setting these values remotely, the position in the list sent corresponds to the offset. Missing values are not permitted, unless the number of values sent is greater than the number of carriers, then subsequent values will be ignored.</p> <p>Offset sub op code. 1 for BTS, 2 for MS. Default is BTS.</p> <p>Note that Offset sub op code 2 is supported only in Non-SA modes.</p> <p>In the SA mode, Offset sub op code 1 is used for both BTS and MS.</p> <p>You must be in the mode that includes ACP measurements to use this command. Use :INSTRument:SElect to set the mode.</p>
Couplings	Changing Offset Frequency might affect the Span. See the Span key section for details.

ACP Measurement
Meas Setup

Preset	<p>SA: 3 MHz, 0 Hz, 0 Hz, 0 Hz, 0 Hz, 0 Hz 3 MHz, 0 Hz, 0 Hz, 0 Hz, 0 Hz, 0 Hz</p> <p>WCDMA: 5.0 MHz, 10.0 MHz, 0 Hz, 0 Hz, 0 Hz, 0 Hz 5.0 MHz, 10.0 MHz, 0 Hz, 0 Hz, 0 Hz, 0 Hz</p> <p>WIMAX OFDMA: 10 MHz, 20 MHz, 0 Hz, 0 Hz, 0 Hz, 0 Hz 10 MHz, 20 MHz, 0 Hz, 0 Hz, 0 Hz, 0 Hz</p> <p>C2K:750KHz, 1.980 MHz, 0 Hz, 0 Hz, 0 Hz, 0 Hz 885 kHz, 1.980 MHz, 0 Hz, 0 Hz, 0 Hz, 0 Hz</p> <p>TD-SCDMA: 1.6 MHz, 3.2 MHz, 0 Hz, 0 Hz, 0 Hz, 0 Hz 1.6 MHz, 3.2 MHz, 0 Hz, 0 Hz, 0 Hz, 0 Hz</p> <p>1xEVDO: 750KHz, 1.98MHz, 3.125MHz, 4.000MHz, 7.500MHz, 7.500MHz 885KHz, 1.98MHz, 3.125MHz, 4.000MHz, 7.500MHz, 7.500MHz</p> <p>DVB-T/H: 8 MHz, 16 MHz, 0 Hz, 0 Hz, 0 Hz, 0 Hz 8 MHz, 16 MHz, 0 Hz, 0 Hz, 0 Hz, 0 Hz</p> <p>DTMB (CTTB): 8 MHz, 16 MHz, 24 MHz, 32 MHz, 0 Hz, 0 Hz 8 MHz, 16 MHz, 24 MHz, 32 MHz, 0 Hz, 0 Hz</p> <p>ISDB-T: 6 MHz, 12 MHz, 0 Hz, 0 Hz, 0 Hz, 0 Hz 6 MHz, 12 MHz, 0 Hz, 0 Hz, 0 Hz, 0 Hz</p> <p>CMMB: 8 MHz, 16 MHz, 24 MHz, 32 MHz, 0 Hz, 0 Hz 8 MHz, 16 MHz, 24 MHz, 32 MHz, 0 Hz, 0 Hz</p> <p>LTE, LTETDD, MSR: 5 MHz,10 MHz,0,0,0,0 5 MHz,10 MHz,0,0,0,0</p> <p>Digital Cable TV: 8 MHz, 16 MHz, 0 Hz, 0 Hz, 0 Hz, 0 Hz 8 MHz, 16 MHz, 0 Hz, 0 Hz, 0 Hz, 0 Hz</p> <p>SA: ON, OFF, OFF, OFF, OFF, OFF ON, OFF, OFF, OFF, OFF, OFF</p> <p>WCDMA: ON, ON, OFF, OFF, OFF, OFF ON, ON, OFF, OFF, OFF, OFF</p> <p>WIMAX OFDMA: ON, ON, OFF, OFF, OFF, OFF ON, ON, OFF, OFF, OFF, OFF</p> <p>TD-SCDMA: ON, ON, OFF, OFF, OFF, OFF ON, ON, OFF, OFF, OFF, OFF</p> <p>DVB-T/H: ON, ON, OFF, OFF, OFF, OFF ON, ON, OFF, OFF, OFF, OFF</p> <p>DTMB (CTTB): ON, ON, OFF, OFF, OFF, OFF ON, ON, OFF, OFF, OFF, OFF</p> <p>CDMA1xEVDO: ON,ON,OFF,OFF,OFF,OFF ON,ON,OFF,OFF,OFF,OFF</p> <p>ISDB-T: ON, ON, OFF, OFF, OFF, OFF ON, ON, OFF, OFF, OFF, OFF</p> <p>CMMB: ON, ON, ON, ON, OFF, OFF ON, ON, ON, ON, OFF, OFF</p> <p>LTE, LTETDD, MSR: ON, ON, OFF, OFF, OFF, OFF ON, OFF, OFF, OFF, OFF, OFF</p> <p>Digital Cable TV: ON, ON, OFF, OFF, OFF, OFF ON, ON, OFF, OFF, OFF, OFF</p>
State Saved	Saved in instrument state.
Min	0 Hz

Max	500 MHz
Backwards Compatibility SCPI	[[:SENSe]:MCPower:OFFSet[1] 2:LIST[:FREQuency] (PSA Power Suite)
Initial S/W Revision	Prior to A.02.00
Modified at S/W Revision	A.02.00, A.03.00

Integ BW

Sets the Integration Bandwidth for the offsets. If there is more than one bandwidth, the list must contain six (6) entries. Each resolution bandwidth in the list corresponds to an offset frequency in the list defined by [:SENSe]:ACP:OFFSet[n]:LIST[:FREQuency].

Enter each value individually by selecting the desired offset on the offset menu key using the up down arrows, the knob, or the numeric keypad, then enter the Offset Integration Bandwidth using the Offset Integration Bandwidth menu key.

You can turn off (not use) specific offsets with the [:SENSe]:ACP:OFFSet[n]:LIST:STATe command."

Key Path	Meas Setup, Offset/Limits
Mode	SA, WCDMA, C2K, WIMAX OFDMA, TD-SCDMA, 1xEVDO, DVB-T/H, DTMB (CTTB), ISDB-T, CMMB, LTE, LTETDD, Digital Cable TV, MSR
Remote Command	[[:SENSe]:ACP:OFFSet[1] 2:LIST:BANDwidth[:INTEgratio n] <bandwidth>, <bandwidth>, <bandwidth>, <bandwidth>, <bandwidth>, <bandwidth> [:SENSe]:ACP:OFFSet[1] 2:LIST:BANDwidth[:INTEgratio n]?
Example	ACP:OFFS2:LIST:BAND 2MHz,2MHz,2MHz,2MHz,2MHz,2MHz ACP:OFFS2:LIST:BAND?
Notes	When setting these values remotely, the position in the list sent corresponds to the offset. Missing values are not permitted i.e. if you want to change values 2 you must send all values up to 2. Subsequent values will remain unchanged, unless the number of values sent is greater than the number of carriers, then subsequent values will be ignored. Offset sub op code. 1 for BTS, 2 for MS. Default is BTS. Note that Offset sub op code 2 is supported only in Non-SA modes. In the SA mode, Offset sub op code 1 is used for both BTS and MS. You must be in the mode that includes ACP measurements to use this command. Use :INSTrument:SElect to set the mode.
Couplings	Changing Integ BW might affect to the Span. See Span section for details.

ACP Measurement
Meas Setup

Preset	<p>SA: 2 MHz, 2 MHz, 2 MHz, 2 MHz, 2 MHz, 2 MHz 2 MHz, 2 MHz, 2 MHz, 2 MHz, 2 MHz, 2 MHz</p> <p>WCDMA: 3.84 MHz, 3.84 MHz, 3.84 MHz, 3.84 MHz, 3.84 MHz, 3.84 MHz 3.84 MHz, 3.84 MHz, 3.84 MHz, 3.84 MHz, 3.84 MHz, 3.84 MHz</p> <p>WIMAX OFDMA: 10 MHz, 10 MHz, 10 MHz, 10 MHz, 10 MHz, 10 MHz 10 MHz, 10 MHz, 10 MHz, 10 MHz, 10 MHz, 10 MHz</p> <p>C2K: 30 kHz, 30 kHz, 30 kHz, 30 kHz, 30 kHz, 30 kHz 30 kHz, 30 kHz, 30 kHz, 30 kHz, 30 kHz, 30 kHz</p> <p>TD-SCDMA: 1.28 MHz, 1.28 MHz, 1.28 MHz, 1.28 MHz, 1.28 MHz, 1.28 MHz</p> <p>1xEVDO: C2K: 30 kHz, 30 kHz, 30 kHz, 30 kHz, 30 kHz, 30 kHz 30 kHz, 30 kHz, 30 kHz, 30 kHz, 30 kHz, 30 kHz</p> <p>DVB-T/H: 7.61 MHz, 7.61 MHz, 7.61 MHz, 7.61 MHz, 7.61 MHz, 7.61 MHz 7.61 MHz, 7.61 MHz, 7.61 MHz, 7.61 MHz, 7.61 MHz, 7.61 MHz</p> <p>DTMB (CTTB): 7.56 MHz, 7.56 MHz, 7.56 MHz, 7.56 MHz, 7.56 MHz, 7.56 MHz 7.56 MHz, 7.56 MHz, 7.56 MHz, 7.56 MHz, 7.56 MHz, 7.56 MHz</p> <p>ISDB-T: 5.6 MHz, 5.6 MHz, 5.6 MHz, 5.6 MHz, 5.6 MHz, 5.6 MHz 5.6 MHz, 5.6 MHz, 5.6 MHz, 5.6 MHz, 5.6 MHz, 5.6 MHz</p> <p>CMMB: 7.512 MHz, 7.512 MHz, 7.512 MHz, 7.512 MHz, 7.512 MHz, 7.512 MHz 7.512 MHz, 7.512 MHz, 7.512 MHz, 7.512 MHz, 7.512 MHz, 7.512 MHz</p> <p>LTE, LTETDD, MSR: 4.515 MHz, 4.515 MHz, 4.515 MHz, 4.515 MHz, 4.515 MHz, 4.515 MHz 4.5 MHz, 4.5 MHz, 4.5 MHz, 4.5 MHz, 4.5 MHz, 4.5 MHz</p> <p>Digital Cable TV: 8.0 MHz, 8.0 MHz, 8.0 MHz, 8.0 MHz, 8.0 MHz, 8.0 MHz 8.0 MHz, 8.0 MHz, 8.0 MHz, 8.0 MHz, 8.0 MHz, 8.0 MHz</p>
State Saved	Saved in instrument state.
Min	10 Hz
Max	1 GHz
Backwards Compatibility SCPI	<p>[[:SENSE]:ACPower:OFFSet[1]]2:LIST:BWIDth[:INTegration]</p> <p>[[:SENSE]:ACPR:OFFSet[1]]2:LIST:BANDwidth</p> <p>[[:SENSE]:ACPR:OFFSet[1]]2:LIST:BWIDth</p> <p>[[:SENSE]:MCPower:OFFSet[1]]2:LIST:BANDwidth[:INTegration] (PSA Power Suite)</p> <p>[[:SENSE]:MCPower:OFFSet[1]]2:LIST:BWIDth[:INTegration] (PSA Power Suite)</p>
Initial S/W Revision	Prior to A.02.00
Modified at S/W Revision	A.02.00, A.03.00

Offset BW

Accesses the offset bandwidth menu.

Key Path	Meas Setup, Offset/Limits
Initial S/W Revision	Prior to A.02.00

Res BW

Sets the resolution bandwidth. If an unavailable bandwidth is entered with the numeric keypad, the closest available bandwidth is selected.

Key Path	Meas Setup, Offset/Limits
Mode	SA, WCDMA, C2K, WIMAX OFDMA, TD-SCDMA, 1xEVDO, DVB-T/H, DTMB (CTTB), ISDB-T, CMMB, LTE, LTETDD, Digital Cable TV, MSR
Remote Command	<pre>[:SENSE]:ACPower:OFFSet[1] 2:LIST:BANDwidth:RESolution <bandwidth>, <bandwidth>, <bandwidth>, <bandwidth>, <bandwidth>, <bandwidth> [:SENSE]:ACPower:OFFSet[1] 2:LIST:BANDwidth:RESolution? [:SENSE]:ACPower:OFFSet[1] 2:LIST:BANDwidth:RESolution: AUTO ON OFF 1 0, ON OFF 1 0, ON OFF 1 0, ON OFF 1 0, ON OFF 1 0, ON OFF 1 0 [:SENSE]:ACPower:OFFSet[1] 2:LIST:BANDwidth:RESolution: AUTO?</pre>
Example	<pre>ACP:OFFS2:LIST:BAND:RES 220kHz,220kHz,220kHz,220kHz,220kHz,220kHz ACP:OFFS2:LIST:BAND:RES? ACP:OFFS2:LIST:BAND:RES:AUTO 1,1,1,1,1,1 ACP:OFFS2:LIST:BAND:RES:AUTO?</pre>
Notes	<p>This key is available only in the IBW mode.</p> <p>Offset sub op code. 1 for BTS, 2 for MS. Default is BTS.</p> <p>Note that Offset sub op code 2 is supported only in Non-SA modes.</p> <p>In the SA mode, Offset sub op code 1 is used for both BTS and MS.</p> <p>You must be in the mode that includes ACP measurements to use this command. Use :INSTrument:SELEct to set the mode.</p>
Dependencies	When Meas Method is RBW or FAST, this key is grayed out and disabled. If the key is pressed, an advisory message is generated. If the equivalent remote command is sent, a "Setting conflict" warning is generated.
Couplings	When Res BW Mode is AUTO, this value is exactly same as Res BW under BW key. And when this value is changed by user, Res BW Mode is also changed to Man.

ACP Measurement
Meas Setup

Preset	<p>SA: 220 kHz, 220 kHz, 220 kHz, 220 kHz, 220 kHz, 220 kHz</p> <p>WCDMA: 100 kHz, 100 kHz, 100 kHz, 100 kHz, 100 kHz, 100 kHz</p> <p>WIMAX OFDMA: 100 kHz, 100 kHz, 100 kHz, 100 kHz, 100 kHz, 100 kHz</p> <p>C2K:</p> <p>Method:RBW</p> <p>30 kHz</p> <p>Method: IBW</p> <p>C2K: 15 kHz, 15 kHz, 15 kHz, 15 kHz,15 kHz, 15 kHz 15 kHz, 15 kHz, 15 kHz, 15 kHz,15 kHz, 15 kHz</p> <p>TD-SCDMA: 30 kHz, 30 kHz, 30 kHz, 30 kHz, 30 kHz, 30 kHz</p> <p>1xEVDO: 30KHz, 30KHz, 30KHz, 30KHz,30KHz, 30KHz 30KHz, 30KHz, 30KHz, 30KHz,30KHz, 30KHz</p> <p>DVB-T/H: 39 kHz, 39 kHz, 39 kHz, 39 kHz,39 kHz, 39 kHz 39 kHz, 39 kHz, 39 kHz, 39 kHz, 39 kHz, 39 kHz</p> <p>DTMB (CTTB): 39 kHz, 39 kHz, 39 kHz, 39 kHz,39 kHz, 39 kHz 39 kHz, 39 kHz, 39 kHz, 39 kHz, 39 kHz, 39 kHz</p> <p>ISDB-T: 39 kHz, 39 kHz, 39 kHz, 39 kHz,39 kHz, 39 kHz 39 kHz, 39 kHz, 39 kHz, 39 kHz, 39 kHz, 39 kHz</p> <p>CMMB: 39 kHz, 39 kHz, 39 kHz, 39 kHz,39 kHz, 39 kHz 39 kHz, 39 kHz, 39 kHz, 39 kHz, 39 kHz, 39 kHz</p> <p>LTE, LTETDD, MSR: 100 kHz,100 kHz,100 kHz,100 kHz,100kHz,100 kHz 100 kHz,100 kHz,100 kHz,100 kHz,100 kHz,100 kHz</p> <p>Digital Cable TV: 39 kHz, 39 kHz, 39 kHz, 39 kHz,39 kHz, 39 kHz 39 kHz, 39 kHz, 39 kHz, 39 kHz, 39 kHz, 39 kHz</p> <p>1, 1, 1, 1, 1, 1</p>
State Saved	Saved in instrument state.
Min	1 Hz
Max	8 MHz
Backwards Compatibility SCPI	[:SENSe]:ACPower:OFFSet[1] 2:LIST:BWIDth:RESolution
Initial S/W Revision	Prior to A.02.00
Modified at S/W Revision	A.02.00, A.03.00

Video BW

Enables you to change the analyzer post-detection filter (VBW).

Key Path	Meas Setup, Offset/Limits, Offset BW
Mode	SA, WCDMA, C2K, WIMAX OFDMA, TD-SCDMA, 1xEVDO, DVB-T/H, DTMB (CTTB), ISDB-T, CMMB, LTE, LTETDD, Digital Cable TV, MSR

<p>Remote Command</p>	<pre>[:SENSe]:ACPower:OFFSet[1] 2:LIST:BANDwidth:VIDeo <freq>, <freq>, <freq>, <freq>, <freq>, <freq> [:SENSe]:ACPower:OFFSet[1] 2:LIST:BANDwidth:VIDeo? [:SENSe]:ACPower:OFFSet[1] 2:LIST:BANDwidth:VIDeo:AUTO OFF ON 0 1, OFF ON 0 1, OFF ON 0 1, OFF ON 0 1, OFF ON 0 1, OFF ON 0 1 [:SENSe]:ACPower:OFFSet[1] 2:LIST:BANDwidth:VIDeo:AUTO?</pre>
<p>Example</p>	<pre>ACP:OFFS2:LIST:BAND:VID 5MHz,5MHz,5MHz,5MHz,5MHz,5MHz ACP:OFFS2:LIST:BAND:VID? ACP:OFFS2:LIST:BAND:VID:AUTO 0,0,0,0,1,1 ACP:OFFS2:LIST:BAND:VID:AUTO?</pre>
<p>Notes</p>	<p>The values shown in this table reflect the conditions after a Mode Preset. Offset sub op code. 1 for BTS, 2 for MS. Default is BTS. Note that Offset sub op code 2 is supported only in Non-SA modes. In the SA mode, Offset sub op code 1 is used for both BTS and MS. You must be in the mode that includes ACP measurements to use this command. Use :INSTrument:SELEct to set the mode. .</p>
<p>Dependencies</p>	<p>When Meas Method is RBW or FAST, this key is grayed out and disabled. If the key is pressed, an advisory message is generated. If the equivalent remote command is sent, a "Setting conflict" warning is generated.</p>

ACP Measurement
Meas Setup

Preset	SA: 22 kHz, 22 kHz, 22 kHz, 22 kHz, 22 kHz, 22 kHz WCDMA, WIMAX OFDMA: 1 MHz, 1 MHz, 1 MHz, 1 MHz, 1 MHz, 1 MHz C2K: 150 kHz, 150 kHz, 150 kHz, 150 kHz, 150 kHz, 150 kHz 150 kHz, 150 kHz, 150 kHz, 1150 kHz, 1150 kHz, 150 kHz TD-SCDMA: 300 kHz, 300 kHz, 300 kHz, 300 kHz, 300 kHz, 300 kHz 1xEVDO: 300KHz, 300KHz, 300KHz, 300KHz, 300KHz, 300KHz 300KHz, 300KHz, 300KHz, 300KHz, 300KHz, 300KHz DVB-T/H: 390 kHz, 390 kHz, 390 kHz, 390 kHz,390 kHz, 390 kHz 390 kHz, 390 kHz, 390 kHz, 390 kHz, 390 kHz DTMB (CTTB): 390 kHz, 390 kHz, 390 kHz, 390 kHz,390 kHz, 390 kHz 390 kHz, 390 kHz, 390 kHz, 390 kHz, 390 kHz ISDB-T: 390 kHz, 390 kHz, 390 kHz, 390 kHz,390 kHz, 390 kHz 390 kHz, 390 kHz, 390 kHz, 390 kHz, 390 kHz CMMB: 390 kHz, 390 kHz, 390 kHz, 390 kHz,390 kHz, 390 kHz 390 kHz, 390 kHz, 390 kHz, 390 kHz, 390 kHz LTE, LTETDD, MSR: 1 MHz,1 MHz,1 MHz,1 MHz,1 MHz,1 MHz Digital Cable TV: 390 kHz, 390 kHz, 390 kHz, 390 kHz,390 kHz, 390 kHz 390 kHz, 390 kHz, 390 kHz, 390 kHz, 390 kHz, 390 kHz ON, ON, ON, ON, ON, ON
State Saved	Saved in instrument state.
Min	1 Hz
Max	50 MHz
Backwards Compatibility SCPI	[:SENSe]:ACPower:OFFSet[1]]2:LIST:BWIDth:VIDeo
Initial S/W Revision	Prior to A.02.00
Modified at S/W Revision	A.02.00, A.03.00

RBW Control

Accesses the resolution bandwidth control menu.

Key Path	Meas Setup, Offset/Limits, Offset BW
Initial S/W Revision	Prior to A.02.00

Filter Type

Selects the type of bandwidth filter that is used.

Key Path	Meas Setup, Offset/Limits, Offset BW, RBW Control
Mode	SA, WCDMA, C2K, WIMAX OFDMA, TD-SCDMA, 1xEVDO, DVB-T/H, DTMB (CTTB), ISDB-T, CMMB, LTE, LTETDD, Digital Cable TV, MSR

Remote Command	[:SENSE]:ACPower:OFFSet[1] 2:LIST:BANDwidth:SHAPE GAUSSian FLATtop, GAUSSian FLATtop, GAUSSian FLATtop, GAUSSian FLATtop, GAUSSian FLATtop, GAUSSian FLATtop [:SENSE]:ACPower:OFFSet[1] 2:LIST:BANDwidth:SHAPE?
Example	ACP:OFFS2:LIST:BAND:SHAP FLAT,GAUS,GAUS,GAUS,GAUS,GAUS ACP:OFFS2:LIST:BAND:SHAP?
Notes	Offset sub op code. 1 for BTS, 2 for MS. Default is BTS. Note that Offset sub op code 2 is supported only in Non-SA modes. In the SA mode, Offset sub op code 1 is used for both BTS and MS. You must be in the mode that includes ACP measurements to use this command. Use :INSTrument:SElect to set the mode.
Dependencies	When Res BW Mode for the offset is Auto, this key is grayed out and disabled. Since Res BW Mode for the offset is presetted to Auto on changing Meas Method to RBW or FAST, this key is grayed out and disabled too. If the key is pressed, an advisory message is generated. If the equivalent remote command is sent, a "Setting conflict" warning is generated.
Couplings	See the description above
Preset	GAUSSian, GAUSSian, GAUSSian, GAUSSian, GAUSSian, GAUSSian
State Saved	Saved in instrument state.
Range	GAUSSian FLATtop
Backwards Compatibility SCPI	[:SENSE]:ACPower:OFFSet[1] 2:LIST:BWIDth:SHAPE
Initial S/W Revision	Prior to A.02.00
Modified at S/W Revision	A.02.00, A.03.00

Filter BW

Selects a Gaussian filter based on its –3 dB (Normal) bandwidth or its –6 dB bandwidth.

Key Path	Meas Setup, Offset/Limits, Offset BW, RBW Control
Mode	SA, WCDMA, C2K, WIMAX OFDMA, TD-SCDMA, 1xEVDO, DVB-T/H, DTMB (CTTB), ISDB-T, CMMB, LTE, LTETDD, Digital Cable TV, MSR
Remote Command	[:SENSE]:ACPower:OFFSet[1] 2:LIST:BANDwidth:TYPE DB3 DB6, DB3 DB6, DB3 DB6, DB3 DB6, DB3 DB6, DB3 DB6 [:SENSE]:ACPower:OFFSet[1] 2:LIST:BANDwidth:TYPE?
Example	ACP:OFFS2:LIST:BAND:TYPE DB3,DB3,DB3,DB3,DB3 ACP:OFFS2:LIST:BAND:TYPE?

ACP Measurement
Meas Setup

Notes	Offset sub op code. 1 for BTS, 2 for MS. Default is BTS. Note that Offset sub op code 2 is supported only in Non-SA modes. In the SA mode, Offset sub op code 1 is used for both BTS and MS. You must be in the mode that includes ACP measurements to use this command. Use :INSTrument:SELEct to set the mode.
Dependencies	When Filter Type if Flattop or Res BW Mode for the offset is Auto, this key is grayed out and disabled. Since Res BW Mode for the offset is presetted to Auto on changing Meas Method to RBW or FAST, this key is grayed out and disabled too. If the key is pressed, an advisory message is generated. If the equivalent remote command is sent, a "Setting conflict" warning is generated.
Preset	DB3, DB3, DB3, DB3, DB3, DB3
State Saved	Saved in instrument state.
Range	-3 dB (Normal) -6 dB
Backwards Compatibility SCPI	[:SENSe]:ACPpower:OFFSet[1] 2:LIST:BWIDth:TYPE
Initial S/W Revision	Prior to A.02.00
Modified at S/W Revision	A.02.00, A.03.00

Limits

Limits key accesses a menu of functions that contains Select Offset, Abs Limit, Rel Limit and Fail Mask parameters.

Key Path	Meas Setup, Offset/Limits
Initial S/W Revision	A.03.00

Abs Limit

Enters an absolute limit value, which sets the absolute amplitude levels to test against for each of the custom offsets. The list must contain six (6) entries. If there is more than one offset, the offset closest to the carrier channel is the first one in the list. [:SENSe]:ACP:OFFSet[n]:LIST:TEST selects the type of testing to be done at each offset.

You can turn off (not use) specific offsets with the [:SENSe]:ACP:OFFSet[n]:LIST:STATe command.

The query returns the six (6) sets of real numbers that are the current absolute amplitude test limits.

Key Path	Meas Setup, Offset/Limits, Limits
Mode	SA, WCDMA, C2K, WIMAX OFDMA, TD-SCDMA, 1xEVDO, DVB-T/H, DTMB (CTTB), ISDB-T, CMMB, LTE, LTETDD, Digital Cable TV, MSR
Remote Command	[:SENSe]:ACPpower:OFFSet[1] 2:LIST:ABSolute <real>, <real>, <real>, <real>, <real> [:SENSe]:ACPpower:OFFSet[1] 2:LIST:ABSolute?

Example	ACP:OFFS2:LIST:ABS -10,-10,-10,-10,-10,-10 ACP:OFFS2:LIST:ABS?
Notes	Offset sub op code. 1 for BTS, 2 for MS. Default is BTS. Note that Offset sub op code 2 is supported only in Non-SA modes. In the SA mode, Offset sub op code 1 is used for both BTS and MS. You must be in the mode that includes ACP measurements to use this command. Use :INSTrument:SElect to set the mode.
Couplings	None If current mode is DTMB (CTTB) or CMMB and current device type is Transmitter, the value from position 2 to position 4 are coupled, changing any one will change the others.
Preset	SA: 0dBm, 0 dBm, 0 dBm, 0 dBm, 0 dBm, 0 dBm 0dBm, 0 dBm, 0 dBm, 0 dBm, 0 dBm, 0 dBm WCDMA: 50 dBm, 50 dBm, 50 dBm, 50 dBm, 50 dBm, 50 dBm 50 dBm, 50 dBm, 50 dBm, 50 dBm, 50 dBm C2K: 50 dBm, 50 dBm, 50 dBm, 50 dBm, 50 dBm, 50 dBm 50 dBm, 50 dBm, 50 dBm, 50 dBm, 50 dBm WIMAX OFDMA: 50,50,50,50,50,50 TD-SCDMA: 50 dBm, 50 dBm, 50 dBm, 50 dBm, 50 dBm, 50 dBm 50 dBm, 50 dBm, 50 dBm, 50 dBm, 50 dBm 1xEVDO: -27dBm, -27dBm, -13dBm, -13dBm, -13dBm, -13dBm -27dBm, -27dBm, -13dBm, -13dBm, -13dBm, -13dBm DVB-T/H: 50 dBm, 50 dBm, 50 dBm, 50 dBm, 50 dBm, 50 dBm 50 dBm, 50 dBm, 50 dBm, 50 dBm, 50 dBm DTMB (CTTB): 11.14 dBm, 11.14dBm, 11.14 dBm, 11.14 dBm, 50 dBm, 50 dBm 11.14 dBm, 11.14 dBm, 11.14 dBm, 11.14 dBm, 50 dBm, 50 dBm ISDB-T: 50 dBm, 50 dBm, 50 dBm, 50 dBm, 50 dBm, 50 dBm 50 dBm, 50 dBm, 50 dBm, 50 dBm, 50 dBm CMMB: 11.14 dBm, 11.14dBm, 11.14 dBm, 11.14 dBm, 50 dBm, 50 dBm 11.14 dBm, 11.14 dBm, 11.14 dBm, 11.14 dBm, 50 dBm, 50 dBm LTE, LTETDD, MSR: -8.45,-8.45,-8.45,-8.45,-8.45,-8.45 -50.0,-50.0,-50.0,-50.0,-50.0,-50.0 Digital Cable TV: 50 dBm, 50 dBm, 50 dBm, 50 dBm, 50 dBm, 50 dBm 50 dBm, 50 dBm, 50 dBm, 50 dBm, 50 dBm, 50 dBm
State Saved	Saved in instrument state.
Min	-200.0 dBm
Max	50.0 dBm

ACP Measurement
Meas Setup

Backwards Compatibility SCPI	[[:SENSe]:ACPR:OFFSet[1]]2:LIST:ABSolute (PSA W-CDMA, PSA cdma2000) [:SENSe]:MCPower:OFFSet[1]]2:LIST:ABSolute (PSA W-CDMA)
Initial S/W Revision	Prior to A.02.00
Modified at S/W Revision	A.02.00, A.03.00

Rel Lim (Car)

Enters a relative limit value for the carrier level. This sets the amplitude levels to test against for the specified offsets.

The amplitude level is relative to the carrier amplitude. If multiple offsets are available, the list contains six (6) entries. The offset closest to the carrier channel is the first one in the list.

[[:SENSe]:ACP:OFFSet:LIST:TEST selects the type of testing to be done at each offset.

[[:SENSe]:ACP:OFFSet[n]:LIST[n]:TEST selects the type of testing to be done at each offset.

You can turn off (not use) specific offsets with the [[:SENSe]:ACP:OFFSet[n]:LIST[n]:STATE command.

The query returns the six (6) sets of real numbers that are the current amplitude test limits, relative to the carrier, for each offset.

Offset[n] n = 1 is base station and n = 2 is mobiles. The default is base station (1).

Key Path	Meas Setup, Offset/Limits, Limits,
Mode	SA, WCDMA, C2K, WIMAX OFDMA, TD-SCDMA, 1xEVDO, DVB-T/H, DTMB (CTTB), ISDB-T, CMMB, LTE, LTETDD, Digital Cable TV, MSR
Remote Command	[[:SENSe]:ACPower:OFFSet[1]]2:LIST:RCARrier <real>, <real>, <real>, <real>, <real> [:SENSe]:ACPower:OFFSet[1]]2:LIST:RCARrier?
Example	ACP:OFFS2:LIST:RCAR 0,0,0,0,0 ACP:OFFS2:LIST:RCAR?
Notes	Offset sub op code. 1 for BTS, 2 for MS. Default is BTS. Note that Offset sub op code 2 is supported only in Non-SA modes. In the SA mode, Offset sub op code 1 is used for both BTS and MS. You must be in the mode that includes ACP measurements to use this command. Use :INSTrument:SElect to set the mode.
Couplings	None If current mode is DTMB (CTTB) or CMMB and current device type is Transmitter, the value from position 2 to position 4 are coupled, changing any one will change the others.

Preset	SA: -45, -60, 0, 0, 0, 0 -45, -60, 0, 0, 0, 0 WCDMA: -44.2, -49.2, -49.2, -49.2, -49.2, -49.2 -32.2, -42.2, -42.2, -42.2, -42.2, -42.2 C2K: 0, 0, 0, 0, 0, 0 0, 0, 0, 0, 0, 0 WIMAX OFDMA: -50,-60,0,0,0,0 TD-SCDMA: -40, -45, -45, -45, -45, -45 -33, -43, -43, -43, -43, -43 1xEVDO: -45, -55, -55, -55, -55, -55 -45, -55, -55, -55, -55, -55 DVB-T/H: -60, -60, 0, 0, 0, 0 -60, -60, 0, 0, 0, 0 DTMB (CTTB): -45, -60, -60, -60, 50, 50 -45, -60, -60, -60, 50, 50 ISDB-T: -60, -60, 0, 0, 0, 0 -60, -60, 0, 0, 0, 0 CMMB: -45, -60, -60, -60, 50, 50 -45, -60, -60, -60, 50, 50 LTE, LTETDD, MSR: -44.2,-44.2,-44.2,-44.2,-44.2,-44.2 -29.2, -29.2, -29.2, -29.2, -29.2, -29.2 Digital Cable TV: -58, -62, -65, -73, -73, -73 -58, -62, -65, -73, -73, -73
State Saved	Saved in instrument state.
Min	-150
Max	50.0
Backwards Compatibility SCPI	[:SENSe]:MCPower:OFFSet[1]]2:LIST:RCARrier (PSA WCDMA)
Initial S/W Revision	Prior to A.02.00
Modified at S/W Revision	A.02.00, A.03.00, A.04.00

Positive Offset Limit

Enables you to set the upper limit for the upper segment of the specified offset pair.

Mode	SA, WCDMA, C2K, WIMAX OFDMA, TD-SCDMA, 1xEVDO, DVB-T/H, DTMB (CTTB), LTE, LTETDD, Digital Cable TV, MSR
Remote Command	:CALCulate:ACPpower:OFFSet:LIST:LIMit:POSitive[:UPPer]:DATA <real>, <real>, <real>, <real>, <real>, <real> :CALCulate:ACPpower:OFFSet:LIST:LIMit:POSitive[:UPPer]:DATA?
Example	CALC:ACP:OFFS:LIST:LIM:POS:DATA 0,0,0,0,0,0 CALC:ACP:OFFS:LIST:LIM:POS:DATA?
Notes	SCPI only command

ACP Measurement
Meas Setup

Preset	SA: -45, -60, 0, 0, 0, 0 -45, -60, 0, 0, 0, 0 WCDMA: -44.2, -49.2, -49.2, -49.2, -49.2, -49.2 -32.2, -42.2, -42.2, -42.2, -42.2, -42.2 C2K: 0, 0, 0, 0, 0, 0 0, 0, 0, 0, 0, 0 WIMAX OFDMA: -50, -60, 0, 0, 0, 0 TD-SCDMA: -40, -45, -45, -45, -45, -45 -33, -43, -43, -43, -43, -43 1xEVDO: -45, -55, -55, -55, -55, -55 -45, -55, -55, -55, -55, -55 DVB-T/H: -60, -60, 0, 0, 0, 0 -60, -60, 0, 0, 0, 0 DTMB (CTTB): -45, -60, -60, -60, 0, 0 -45, -60, -60, -60, 0, 0 Digital Cable TV: -58, -62, -65, -73, -73, -73 -58, -62, -65, -73, -73, -73 LTE, LTETDD, MSR: -44.2, -44.2, -44.2, -44.2, -44.2, -44.2 -29.2, -29.2, -29.2, -29.2, -29.2, -29.2
State Saved	Saved in instrument state.
Min	-150.0
Max	50.0
Backwards Compatibility SCPI	:CALCulate:MCPower:OFFSet:LIST:LIMit:POSitive[:UPPer]:DATA (PSA Power Suite)
Initial S/W Revision	A.04.00

Negative Offset Limit

Enables you to set the upper limit for the lower segment of the specified offset pair.

Mode	SA, WCDMA, C2K, WIMAX OFDMA, TD-SCDMA, 1xEVDO, DVB-T/H, DTMB (CTTB), LTE, LTETDD, Digital Cable TV, MSR
Remote Command	:CALCulate:ACPower:OFFSet:LIST:LIMit:NEGative[:UPPer]:DATA <real>, <real>, <real>, <real>, <real>, <real> :CALCulate:ACPower:OFFSet:LIST:LIMit:NEGative[:UPPer]:DATA?
Example	CALC:ACP:OFFS:LIST:LIM:NEG:DATA 0,0,0,0,0,0 CALC:ACP:OFFS:LIST:LIM:NEG:DATA?
Notes	SCPI only command

Preset	SA: -45, -60, 0, 0, 0, 0 -45, -60, 0, 0, 0, 0 WCDMA: -44.2, -49.2, -49.2, -49.2, -49.2, -49.2 -32.2, -42.2, -42.2, -42.2, -42.2, -42.2 C2K: 0, 0, 0, 0, 0, 0 0, 0, 0, 0, 0, 0 WIMAX OFDMA: -50, -60, 0, 0, 0, 0 TD-SCDMA: -40, -45, -45, -45, -45, -45 -33, -43, -43, -43, -43, -43 1xEVDO: -45, -55, -55, -55, -55, -55 -45, -55, -55, -55, -55, -55 DVB-T/H: -60, -60, 0, 0, 0, 0 -60, -60, 0, 0, 0, 0 DTMB (CTTB): -45, -60, -60, -60, 0, 0 -45, -60, -60, -60, 0, 0 Digital Cable TV: -58, -62, -65, -73, -73, -73 -58, -62, -65, -73, -73, -73 LTE, LTETDD, MSR: -44.2, -44.2, -44.2, -44.2, -44.2, -44.2 -29.2, -29.2, -29.2, -29.2, -29.2, -29.2
State Saved	Saved in instrument state.
Min	-150.0
Max	50.0
Backwards Compatibility SCPI	:CALCulate:MCPower:OFFSet:LIST:LIMit:NEGative[:UPPer]:DATA (PSA Power Suite)
Initial S/W Revision	A.04.00

Rel Lim (PSD)

Enters a relative limit value for the level of the power spectral density. This sets the amplitude levels to test against for any custom offsets. The amplitude level is relative to the power spectral density. If multiple offsets are available, the list contains six (6) entries. The offset closest to the carrier channel is the first one in the list.

[[:SENSe]:ACP:OFFSet[n]:LIST[n]:TEST selects the type of testing to be done at each offset.

You can turn off (not use) specific offsets with the [[:SENSe]:ACP:OFFSet[n]:LIST:STATe command.

The query returns the six (6) sets of real numbers that are the current amplitude test limits, relative to the power spectral density, for each offset.

Offset[n] n = 1 is base station and n = 2 is mobiles. The default is base station (1).

Key Path	Meas Setup, Offset/Limits, Limits
Mode	SA, WCDMA, C2K, WIMAX OFDMA, TD-SCDMA, 1xEVDO, DVB-T/H, DTMB (CTTB), ISDB-T, CMMB, LTE, LTETDD, Digital Cable TV, MSR
Remote Command	[[:SENSe]:ACPower:OFFSet[1] 2:LIST:RPSDensity <rel_ampl>, <rel_ampl>, <rel_ampl>, <rel_ampl>, <rel_ampl>, <rel_ampl> [[:SENSe]:ACPower:OFFSet[1] 2:LIST:RPSDensity?

ACP Measurement
Meas Setup

Example	ACP:OFFS2:LIST:RPSD 10,10,10,10,10,10 ACP:OFFS2:LIST:RPSD?
Notes	Offset sub op code. 1 for BTS, 2 for MS. Default is BTS. Note that Offset sub op code 2 is supported only in Non-SA modes. In the SA mode, Offset sub op code 1 is used for both BTS and MS. You must be in the mode that includes ACP measurements to use this command. Use :INSTrument:SELEct to set the mode.
Preset	SA: -28.87 dB, -43.87 dB, 0 dB, 0 dB, 0 dB, 0 dB -28.87 dB, -43.87 dB, 0 dB, 0 dB, 0 dB, 0 dB WCDMA: -44.2 dB, -49.2 dB, -49.2 dB, -49.2 dB, -49.2 dB, -49.2 dB -32.2 dB, -42.2 dB, -42.2 dB, -42.2 dB, -42.2 dB, -42.2 dB C2K: 0 dB, 0 dB, 0 dB, 0 dB, 0 dB, 0 dB 0 dB, 0 dB, 0 dB, 0 dB, 0 dB, 0 dB WIMAX OFDMA: -25,-35,0,0,0,0 TD-SCDMA: -40 dB, -45 dB, -45 dB, -45 dB, -45 dB, -45 dB -33 dB, -43 dB, -43 dB, -43 dB, -43 dB, -43 dB 1xEVDO: -45, -55, -55, -55, -55, -55 -45, -55, -55, -55, -55, -55 DVB-T/H: -60 dB, -60 dB, 0 dB, 0 dB, 0 dB, 0 dB -60 dB, -60 dB, 0 dB, 0 dB, 0 dB, 0 dB DTMB (CTTB): 50 dB, 50 dB, 50 dB, 50 dB, 50 dB, 50 dB 50 dB, 50 dB, 50 dB, 50 dB, 50 dB, 50 dB ISDB-T: -60 dB, -60 dB, 0 dB, 0 dB, 0 dB, 0 dB -60 dB, -60 dB, 0 dB, 0 dB, 0 dB, 0 dB CMMB: 50 dB, 50 dB, 50 dB, 50 dB, 50 dB, 50 dB 50 dB, 50 dB, 50 dB, 50 dB, 50 dB, 50 dB LTE, LTETDD, MSR: 0, 0, 0, 0, 0, 0 0, 0, 0, 0, 0, 0 Digital Cable TV: 50 dB, 50 dB, 50 dB, 50 dB, 50 dB, 50 dB 50 dB, 50dB, 50 dB, 50 dB, 50 dB, 50 dB
State Saved	Saved in instrument state.
Min	-150.0 dB
Max	50.0 dB
Initial S/W Revision	Prior to A.02.00
Modified at S/W Revision	A.02.00, A.03.00

Fail Mask

Accesses a menu that enables you to select one of the logic keys for the fail conditions between the measurement results and the test limits. The setting defines the type of testing to be done at any custom offset frequencies. The measured powers are tested against the absolute values defined with [:SENSe]:ACP:OFFSet[n]:LIST:ABSolute, or the relative values defined with [:SENSe]:ACP:OFFSet:LIST:RPSDensity and [:SENSe]:ACP:OFFSet:LIST:RCARrier.

You can turn off (not use) specific offsets with the [:SENSe]:ACP:OFFSet:LIST:STATe command.

- Absolute – Fail is shown if one of the absolute ACP measurement results is larger than the limit for Abs Limit.
- Relative – Fail is shown if one of the relative ACP measurement results is larger than the limit for Rel Lim (Car) or Rel Lim (PSD).
- Abs AND Rel – Fail is shown if one of the absolute ACP measurement results is larger than the limit for Abs Limit AND one of the relative ACP measurement results is larger than the limit for Rel Lim (Car) or Rel Lim (PSD).
- Abs OR Rel – Fail is shown if one of the absolute ACP measurement results is larger than the limit for Abs Limit OR one of the relative ACP measurement results is larger than the limit for Rel Lim (Car) or Rel Lim (PSD).

Key Path	Meas Setup, Offset/Limits, Limits
Mode	SA, WCDMA, C2K, WIMAX OFDMA, TD-SCDMA, 1xEVDO, DVB-T/H, DTMB (CTTB), ISDB-T, CMMB, LTE, LTETDD, Digital Cable TV, MSR
Remote Command	[:SENSe]:ACP:Power:OFFSet[1] 2:LIST:TEST ABSolute AND OR RELative, ABSolute AND OR RELative, ABSolute AND OR RELative, ABSolute AND OR RELative, ABSolute AND OR RELative, ABSolute AND OR RELative [:SENSe]:ACP:Power:OFFSet[1] 2:LIST:TEST?
Example	ACP:OFFS2:LIST:TEST ABS,ABS,ABS,ABS,ABS,ABS ACP:OFFS2:LIST:TEST?
Notes	Offset sub op code. 1 for BTS, 2 for MS. Default is BTS. Note that Offset sub op code 2 is supported only in Non-SA modes. In the SA mode, Offset sub op code 1 is used for both BTS and MS. You must be in the mode that includes ACP measurements to use this command. Use :INSTrument:SELEct to set the mode.
Couplings	None If current mode is DTMB (CTTB) or CMMB and current device type is Transmitter, the value from position 2 to position 4 are coupled, changing any one will change the others.

ACP Measurement
Meas Setup

Preset	SA, WCDMA, C2K, TD-SCDMA: REL, REL, REL, REL, REL, REL REL, REL, REL, REL, REL, REL WIMAX OFDMA: REL, REL, REL, REL, REL, REL DVB-T/H: REL, REL, REL, REL, REL, REL DTMB (CTTB): OR,AND, AND,AND, REL, REL CDMA1xEVDO: REL, REL, ABS, REL, REL, REL REL, REL, ABS, REL, REL, REL ISDB-T : REL, REL, REL, REL, REL, REL CMMB : OR,AND, AND,AND, REL, REL LTE, LTETDD, MSR: AND, AND, AND, AND, AND, AND AND, AND, AND, AND, AND, AND Digital Cable TV: REL, REL, REL, REL, REL, REL
State Saved	Saved in instrument state.
Range	Absolute Relative Abs AND Rel (fail if both fail) Abs OR Rel (fail if either fails)
Backwards Compatibility SCPI	[:SENSe]:MCPower:OFFSet[1] 2:LIST:TEST
Initial S/W Revision	Prior to A.02.00
Modified at S/W Revision	A.02.00, A.03.0, A.04.000

Offset Side

Enables you to turn off (not use) specific offsets.

- NEGative - negative (lower) sideband only
- BOTH - both of the negative (lower) and positive (upper) sidebands
- POSitive - positive (upper) sideband only

Key Path	Meas Setup, Offset/Limits
Mode	SA, WCDMA, C2K, WIMAX OFDMA, TD-SCDMA, 1xEVDO, DTMB (CTTB), DVB-T/H, LTE, LTETDD, Digital Cable TV, MSR
Remote Command	[:SENSe]:ACPpower:OFFSet[1] 2:LIST:SIDE NEGative BOTH POSitive,NEGative BOTH POSitive,NEGative BOTH POSitive,NEGative BOTH POSitive,NEGative BOTH POSitive,NEGative BOTH POSitive,NEGative BOTH POSitive [:SENSe]:ACPpower:OFFSet[1] 2:LIST:SIDE?
Example	ACP:OFFS:LIST:SIDE BOTH ACP:OFFS:LIST:SIDE?

Notes	<p>OFFSet1 is for BTS, 2 for MS. Default is BTS.</p> <p>You must be in the Spectrum Analysis mode, W-CDMA mode, cdma2000 mode, TD-SCDMA mode, DTMB (CTTB) mode, DVB-T/H mode, ISDB-T mode, CMMB mode, Digital Cable TV mode, 1xEVDO mode, WIMAX OFDMA mode, LTE mode, LTETDD or MSR mode to use this command. Use :INSTrument:SElect to set the mode.</p> <p>If you set POS or NEG in an offset, result of the inactive side will return –999.</p>
Preset	BOTH, BOTH, BOTH, BOTH, BOTH, BOTH BOTH, BOTH, BOTH, BOTH, BOTH, BOTH
State Saved	Saved in instrument state.
Range	Neg Both Pos
Initial S/W Revision	A.03.00

Method for Offset

This key allows you to turn RRC filtering of each offset on or off. The value (roll off) for the filter will be set to the value of the Filter Alpha parameter.

Key Path	Meas Setup, Offset/Limits
Mode	SA, WCDMA, WIMAX OFDMA, TD-SCDMA, DVB-T/H, DTMB (CTTB), ISDB-T, CMMB, LTE, LTETDD, Digital Cable TV, MSR
Remote Command	<pre>[:SENSe] :ACPower :OFFSet [1] 2 :LIST :FILTer [:RRC] [:STATe] ON OFF 1 0 , ON OFF 1 0 , ON OFF 1 0 , ON OFF 1 0 , ON OFF 1 0 , ON OFF 1 0 [:SENSe] :ACPower :OFFSet [1] 2 :LIST :FILTer [:RRC] [:STATe] ?</pre>
Example	<pre>ACP:OFFS:LIST:FILT 1,0,0 ACP:OFFS:LIST:FILT?</pre>
Notes	<p>1 ON = RRC Weighted, 0 OFF = Integ BW</p> <p>This parameter is not available for cdma2000 and 1xEVDO.</p> <p>You must be in the mode that includes ACP measurements to use this command. Use :INSTrument:SElect to set the mode.</p>

ACP Measurement
Meas Setup

Preset	SA: 0, 0, 0, 0, 0, 0 0, 0, 0, 0, 0, 0 WCDMA: 1, 1, 1, 1, 1, 1 1, 1, 1, 1, 1, 1 C2K: NO WIMAX OFDMA: 0, 0, 0, 0, 0, 0 0, 0, 0, 0, 0, 0 TD-SCDMA: 1, 1, 1, 1, 1, 1 1, 1, 1, 1, 1, 1 DVB-T/H: 0, 0, 0, 0, 0, 0 0, 0, 0, 0, 0, 0 DTMB (CTTB): 1, 1, 1, 1, 1, 1 1, 1, 1, 1, 1, 1 ISDB-T: 0, 0, 0, 0, 0, 0 0, 0, 0, 0, 0, 0 CMMB: 1, 1, 1, 1, 1, 1 1, 1, 1, 1, 1, 1 LTE: 0, 0, 0, 0, 0, 0 0, 0, 0, 0, 0, 0 LTETDD: 0, 0, 0, 0, 0, 0 0, 0, 0, 0, 0, 0 Digital Cable TV: 0, 0, 0, 0, 0, 0 0, 0, 0, 0, 0, 0 MSR: 0, 0, 0, 0, 0, 0 0, 0, 0, 0, 0, 0
State Saved	Saved in instrument state.
Range	Integ BW RRC Weighted
Initial S/W Revision	A.03.00

Filter Alpha for Offset

Sets the alpha value for the RRC Filter for each offset.

Key Path	Meas Setup, Offset/Limits, Method, RRC Weighted
Mode	SA, WCDMA, WIMAX OFDMA, TD-SCDMA, DVB-T/H, DTMB (CTTB), ISDB-T, CMMB, LTE, LTETDD, Digital Cable TV, MSR
Remote Command	[:SENSe]:ACPpower:OFFSet[1] 2:LIST:FILTer:ALPHa <real>, <real>, <real>, <real>, <real> [:SENSe]:ACPpower:OFFSet[1] 2:LIST:FILTer:ALPHa?
Example	ACP:OFFS:LIST:FILT:ALPH 0.5,0.5,0.5,0.5,0.5,0.5 ACP:OFFS:LIST:FILT:ALPH?
Notes	This parameter is not available for cdma2000 and 1xEVDO. You must be in the mode that includes ACP measurements to use this command. Use :INSTrument:SElect to set the mode.

Preset	SA: 0.22,0.22,0.22,0.22,0.22,0.22 0.22,0.22,0.22,0.22,0.22,0.22 WCDMA: 0.22,0.22,0.22,0.22,0.22,0.22 0.22,0.22,0.22,0.22,0.22,0.22 WIMAX OFDMA: 0.22,0.22,0.22,0.22,0.22,0.22 0.22,0.22,0.22,0.22,0.22,0.22 C2K: NO TD-SCDMA: 0.22,0.22,0.22,0.22,0.22,0.22 0.22,0.22,0.22,0.22,0.22,0.22 DVB-T/H: 0.22,0.22,0.22,0.22,0.22,0.22 0.22,0.22,0.22,0.22,0.22,0.22 DTMB (CTTB): 0.05,0.05,0.05,0.05,0.05,0.05 0.05,0.05,0.05,0.05,0.05,0.05 ISDB-T : 0.22,0.22,0.22,0.22,0.22,0.22 0.22,0.22,0.22,0.22,0.22,0.22 CMMB : 0.22,0.22,0.22,0.22,0.22,0.22 0.22,0.22,0.22,0.22,0.22,0.22 LTE: 0.22,0.22,0.22,0.22,0.22,0.22 0.22,0.22,0.22,0.22,0.22,0.22 LTETDD: 0.22,0.22,0.22,0.22,0.22,0.22 0.22,0.22,0.22,0.22,0.22,0.22 Digital Cable TV: 0.15, 0.15, 0.15, 0.15, 0.15, 0.15 0.15, 0.15, 0.15, 0.15, 0.15, 0.15 MSR: 0.22,0.22,0.22,0.22,0.22,0.22 0.22,0.22,0.22,0.22,0.22,0.22
State Saved	Saved in instrument state.
Min	0.01
Max	1.00
Initial S/W Revision	A.03.00

Offset Frequency Define

This key allows you to select “Offset” definition. Each standard defines each “Offset” from Carrier.

3GPP2 requires the “From Carrier Center to MeasBW Closer Edge” definition. And LTE conformance test requires “From Carrier Edge to MeasBW Center” and/or “From Carrier Edge to MeasBW Closer Edge” definition.

- CTOCenter – From the center of the carrier closest to the adjacent channel to the center of the adjacent channel Offset Integ BW
- CTOEdge - From the center of the carrier closest to the adjacent channel to the edge of the closest adjacent channel Offset Integ BW
- ETOCenter – From Center Frequency - Carrier Spacing / 2 (for lower offset), Center Frequency + Carrier Spacing / 2 (for upper offset) of the carrier closest to the adjacent channel's to the center of the adjacent channel Offset Integ BW
- ETOEdge - From Center Frequency - Carrier Spacing / 2 (for lower offset), Center Frequency + Carrier Spacing / 2 (for upper offset) of the carrier closest to the adjacent channel's to the edge of the closest adjacent channel Offset Integ BW

Key Path	Meas Setup, Offset/Limits
----------	---------------------------

ACP Measurement
Meas Setup

Mode	SA, WCDMA, C2K, WIMAX OFDMA, TD-SCDMA, 1xEVDO, DVB-T/H, DTMB (CTTB), ISDB-T, CMMB, LTE, LTETDD, Digital Cable TV, MSR
Remote Command	[:SENSe] :ACPpower:OFFSet [1] 2 :TYPE CTOCenter CTOEdge ETOCenter ETOEdge [:SENSe] :ACPpower:OFFSet [1] 2 :TYPE?
Example	ACP:OFFS:TYPE ETOC ACP:OFFS:TYPE?
Notes	You must be in the mode that includes ACP measurements to use this command. Use :INSTrument:SELEct to set the mode.
Preset	All Except CDMA1xEVDO: CTOCenter CDMA1xEVDO: CTOEdge
State Saved	Saved in instrument state.
Range	Carrier Center To Meas BW Center Carrier Center To Meas BW Edge Carrier Edge To Meas BW Center Carrier Edge To Meas BW Edge
Initial S/W Revision	A.03.00

Carrier Result

Allows you to view and scroll through the carrier power results.

Key Path	Meas Setup
Mode	SA, WCDMA, C2K, WIMAX OFDMA, TD-SCDMA, 1xEVDO, DVB-T/H, DTMB (CTTB), ISDB-T, CMMB, LTE, LTETDD, Digital Cable TV, MSR
Couplings	This key will be grayed out if there is only one carrier.
Preset	1
State Saved	No
Min	1
Max	Number of carriers.
Initial S/W Revision	Prior to A.02.00
Modified at S/W Revision	A.02.00, A.03.00

PhNoise Opt

Selects the LO (local oscillator) phase noise behavior for various operating conditions.

Key Path	Meas Setup
Initial S/W Revision	Prior to A.02.00

PhNoise Opt Auto

Selects the best LO (local oscillator) phase noise behavior for the ACP measurement.

Auto works as follows:

Looks at all the offsets that are turned on.

Finds the largest and the smallest of the Freq Offset parameters for those offsets.

Takes the mean.

Compares that mean with the crossover frequency for the LO in use (see below).

If the mean is below the crossover frequency, use "best close-in," otherwise use "best wide-offset."

The crossover frequency for PXA is 195 kHz, for MXA and CXA it is 25 kHz.

Key Path	Meas Setup
Mode	SA, WCDMA, C2K, WIMAX OFDMA, TD-SCDMA, 1xEVDO, DVB-T/H, DTMB (CTTB), ISDB-T, CMMB, LTE, LTETDD, Digital Cable TV, MSR
Remote Command	[:SENSe] :ACPower:FREQuency:SYNThesis:AUTO[:STATe] OFF ON 0 1 [:SENSe] :ACPower:FREQuency:SYNThesis:AUTO[:STATe] ?
Example	ACP:FREQ:SYNT:AUTO 1 ACP:FREQ:SYNT:AUTO?
Preset	ON
State Saved	Saved in instrument state.
Range	Auto Man
Initial S/W Revision	Prior to A.02.00
Modified at S/W Revision	A.02.00, A.03.00, A.04.00

PhNoise Opt State

Selects the LO (local oscillator) phase noise behavior for various operating conditions.

Key Path	Meas Setup
Mode	SA, WCDMA, C2K, WIMAX OFDMA, TD-SCDMA, 1xEVDO, DVB-T/H, DTMB (CTTB), ISDB-T, CMMB, LTE, LTETDD, Digital Cable TV, MSR
Remote Command	[:SENSe] :ACPower:FREQuency:SYNThesis[:STATe] 1 2 3 [:SENSe] :ACPower:FREQuency:SYNThesis[:STATe] ?
Example	ACP:FREQ:SYNT 1 ACP:FREQ:SYNT?

Notes	Parameter key: 1 - optimizes phase noise for close-in from the carrier. 2 - optimizes phase noise for wide-offset from the carrier. 3 - optimizes LO for tuning speed.
Preset	Because this function is in Auto after preset, the state of this function after Preset will be automatically calculated.
State Saved	Saved in instrument state.
Range	Hardware Dependent: PXA: Best Close-in Noise [offset < 140 kHz] Best Wide-offset Noise [offset > 160 kHz] Fast Tuning MXA: Best Close-in Noise [offset < 20 kHz] Best Wide-offset Noise [offset > 30 kHz] Fast Tuning CXA: NA
Initial S/W Revision	Prior to A.02.00
Modified at S/W Revision	A.02.00, A.03.00, A.04.00

Meas Method

Sets the desired method to measure ACP.

Integration BW — one sweep of the trace is taken, and the band power for each offset is computed. Depending on the status of the Meas Type parameter (Total Power Reference or PSD Reference), results are displayed relative to the total power or the power spectral density. The display reflects either the current trace or a bar graph view.

Filtered IBW (max dynamic range) — the ACP Path is used to compute ACP when an ACP path is available. This method increases dynamic range, but increases measurement time as it limits the resolution bandwidth. This method is useful for improving dynamic range on a W-CDMA signal because a sharp cutoff bandpass filter is used. The accuracy of the adjacent channel power ratio is not degraded by this method, but the absolute accuracy of both adjacent channel power and carrier power are degraded by up to about 0.5 dB.

RBW — the algorithm uses zero-span and an appropriate RBW setting to capture all of the power in the carrier channel and the offsets. The zero-span algorithm (RBW method) is slower than the IBW method, but greatly improves repeatability.

Fast (in WCDMA mode or SA mode with 3GPP WCDMA radio standard selected) — this provides the same method as the Integration BW method, but is optimized for speed to measure a W-CDMA signal.

Fast (in CDMA2K mode or SA mode with CDMA2K radio standard selected) – this provides faster measurement using the FFT method with a limited parameter flexibility. When this is selected, CDMA2K preset offsets are given and control of the following are grayed out:

BW menu, Sweep/Control menu except Pause/Resume, Trace/Detector menu, Carrier Setup, Offset Limit, RRC Weighting, Filter Alpha, and Noise Correction softkeys in Meas Setup menu.

In the TD-SCDMA mode, only the Integration BW method is available. Therefore, the Meas Method

key is not displayed in the TD-SCDMA mode.

Key Path	Meas Setup
Mode	SA, WCDMA, C2K, WIMAX OFDMA, 1xEVDO, DVB-T/H, DTMB (CTTB), ISDB-T, CMMB, LTE, LTETDD, Digital Cable TV, MSR
Remote Command	[:SENSe] :ACPower :METHod IBW IBWRange FAST RBW [:SENSe] :ACPower :METHod?
Example	ACP:METH IBW ACP:METH?
Notes	In the TDSCDMA mode, only the IBW method is available to use. Therefore, the measure method key is not displayed in the TD-SCDMA mode. CDMA 1xEVDO mode only supports RBW and Integration BW method. C2K mode only supports RBW, Integration BW and FAST method. FAST mode is only supported for WCDMA and C2K signal. You must be in the WCDMA or C2K mode or SA mode with 3GPP WCDMA or CDMA2K radio standard. Otherwise a setting conflict error message will be reported. Supporting FAST mode in C2K is available with the instrument version A.02.00 or later LTETDD mode only supports Integration BW and Filtered IBW method. MSR mode only supports Integration BW and Filtered IBW method. You must be in the mode that includes ACP measurements to use this command. Use :INSTrument:SELEct to set the mode.
Couplings	IBW (Range) restricts the Res BW available for making this measurement to 30 kHz. When selected, the Res BW is clipped to this value if required and an error number displayed.
Preset	SA, LTE, LTETDD, MSR: IBW WCDMA: IBW C2K: RBW WIMAX OFDMA: IBW 1xEVDO: IBW DVB-T/H: IBW DTMB (CTTB): IBW ISDB-T: IBW CMMB: IBW Digital Cable TV: IBW
State Saved	Saved in instrument state.
Range	Integration BW Filtered IBW (max dynamic range) RBW Fast

ACP Measurement
Meas Setup

Readback Text	IBW Filtered IBW RBW Fast
Backwards Compatibility SCPI	[:SENSe]:ACPR:SWEep:TYPE [:SENSe]:MCPower:METhod (PSA Power Suite)
Initial S/W Revision	Prior to A.02.00
Modified at S/W Revision	A.02.00, A.03.00

Meas Type

Changes the reference used for the measurement. This allows you to make absolute and relative power measurements of either total power or the power normalized to the measurement bandwidth.

Total Pwr Ref (TPR) sets the reference to the total carrier power. PSD Ref (PSDR) sets the reference to the power spectral density of the carrier.

Key Path	Meas Setup
Mode	SA, WCDMA, C2K, WIMAX OFDMA, TD-SCDMA, 1xEVDO, DVB-T/H, DTMB (CTTB), ISDB-T, CMMB, LTE, LTETDD, Digital Cable TV, MSR
Remote Command	[:SENSe]:ACPpower:TYPE TPRef PSDRef [:SENSe]:ACPpower:TYPE?
Example	ACP:TYPE PSDR ACP:TYPE?
Notes	You must be in the mode that includes ACP measurements to use this command. Use :INSTrument:SElect to set the mode.
Preset	TPRef
State Saved	Saved in instrument state.
Range	Total Power Ref PSD Ref
Initial S/W Revision	Prior to A.02.00
Modified at S/W Revision	A.02.00, A.03.00

PSD Ref

Sets the unit bandwidth for Power Spectral Density. The available units are dBm/Hz and dBm/MHz.

Key Path	Meas Setup
Mode	A, WCDMA, C2K, WIMAX OFDMA, TD-SCDMA, 1xEVDO, DVB-T/H, DTMB (CTTB), ISDB-T, CMMB, LTE, LTETDD, Digital Cable TV, MSR
Remote Command	:UNIT:ACPpower:POWer:PSD DBMHZ DBMMHZ :UNIT:ACPpower:POWer:PSD?

Example	UNIT:ACP:POW:PSD DBMMHZ UNIT:ACP:POW:PSD?
Couplings	When the PSD unit is changed, the PSD reference result of the “MEAS READ FETCH:ACP[n]?” is also changed by the PSD unit basis (in either dBm/Hz or dBm/MHz).
Preset	DBMHZ
State Saved	Saved in instrument state.
Range	dBm/Hz dBm/MHz
Initial S/W Revision	Prior to A.02.00
Modified at S/W Revision	A.02.00, A.03.00

Limit Test

Turns limit checking for each offset On or Off. The limits may be specified within the Offset menu, for each offset, both sides of the carrier. For results that fail the limit, a red F is appended. In the Combined view, the bar turns red.

Key Path	Meas Setup
Mode	SA, WCDMA, C2K, WIMAX OFDMA, TD-SCDMA, 1xEVDO, DVB-T/H, DTMB (CTTB), ISDB-T, CMMB, LTE, LTETDD, Digital Cable TV, MSR
Remote Command	:CALCulate:ACPpower:LIMit:STATe OFF ON 0 1 :CALCulate:ACPpower:LIMit:STATe?
Example	CALC:ACP:LIM:STAT OFF CALC:ACP:LIM:STAT?
Notes	You must be in the mode that includes ACP measurements to use this command. Use :INSTrument:SELEct to set the mode.

Preset	SA: OFF WCDMA: ON C2K: ON WIMAX OFDMA: OFF TD-SCDMA: ON 1xEVDO: ON DVB-T/H: OFF DTMB (CTTB): ON ISDB-T: OFF CMMB: ON LTE, LTETDD, MSR: ON Digital Cable TV: OFF
State Saved	Saved in instrument state.
Range	On Off
Backwards Compatibility SCPI	[:SENSe]:MCPower:LIMit[:STATe] [:SENSe]:ACPower:LIMit[:STATe]
Initial S/W Revision	Prior to A.02.00
Modified at S/W Revision	A.02.00, A.03.00

Noise Correction

Sets the measurement noise floor correction function to On or Off. On enables measurement noise correction when the measured power in the reference channel or any offset is close to the noise floor of the analyzer. Off turns these corrections off.

In analyzers with the noise floor extensions option (option NFE) enabled, there are two ways to compensate for the analyzer noise floor: through the NFE and through this noise corrections key. The techniques are results are similar but not identical. NFE uses a model of the analyzer noise floor, adapted to the current conditions such as center frequency, RBW and ambient temperature. The parameters of this model are measured in the factory or field calibration in a highly averaged measurement. So they are consistent. However, because the model is imperfect, the corrections are imperfect. Using NFE is very convenient; the user need not wait for the ACP noise corrections calibration to occur. The ACP NC calibration, though, has advantages of being measured very recently, at the current ambient, and the exact center frequency, with no requirement that the model be perfect. So it will often (but not always) have slightly better dynamic range. If both ACP NC is turned on and NFE is turned on, the analyzer uses only the ACP NC. When ACP NC is turned off but NFE is on, NFE is used and performance should still be excellent.

Key Path	Meas Setup
Mode	SA, WCDMA, C2K, WIMAX OFDMA, TD-SCDMA, 1xEVDO, DVB-T/H, DTMB (CTTB), ISDB-T, CMMB, LTE, LTETDD, Digital Cable TV, MSR

Remote Command	[:SENSE]:ACPower:CORRection:NOISe[:AUTO] OFF ON 0 1 [:SENSE]:ACPower:CORRection:NOISe[:AUTO]?
Example	ACP:CORR:NOIS OFF ACP:CORR:NOIS?
Notes	You must be in the mode that includes ACP measurements to use this command. Use :INSTrument:SELEct to set the mode.
Preset	0
State Saved	Saved in instrument state.
Range	On Off
Initial S/W Revision	Prior to A.02.00
Modified at S/W Revision	A.02.00, A.03.00, A.04.00

Meas Preset

Restores all the measurement parameters to their default values.

Key Path	Meas Setup
Mode	SA, WCDMA, C2K, WIMAX OFDMA, TD-SCDMA, 1xEVDO, DVB-T/H, DTMB (CTTB), ISDB-T, CMMB, LTE, LTETDD, Digital Cable TV, MSR
Remote Command	:CONFigure:ACPower
Example	CONF:ACP
Notes	You must be in the mode that includes ACP measurements to use this command. Use :INSTrument:SELEct to set the mode.
Couplings	Selecting Meas Preset will restore all measurement parameters to their default values.
Initial S/W Revision	Prior to A.02.00
Modified at S/W Revision	A.02.00, A.03.00

Offset RRC Weighting (Backward Compatibility SCPI)

Mode	SA, WCDMA, TD-SCDMA, WIMAX OFDMA, DVB-T/H, DTMB (CTTB), ISDB-T, CMMB, LTE, LTETDD, Digital Cable TV, MSR
Remote Command	[:SENSE]:ACPower:FILTer[:RRC][:STATe] OFF ON 0 1 [:SENSE]:ACPower:FILTer[:RRC][:STATe]?
Example	ACP:FILT OFF ACP:FILT?

Notes	<p>This parameter is not available for cdma2000 and 1xEVDO</p> <p>The backwards Compatibility SCPI command, [:SENSe]:ACPR:FILTer[:RRC][:STATe], is provided to support same functionality as [:SENSe]:ACPr:FILTer[:RRC][:STATe] (PSA W-CDMA, PSA cdma2000 and PSA 1xEVDO) due to ACPr node conflicts with ACPower node.</p> <p>You must be in the mode that includes ACP measurements to use this command. Use :INSTrument:SELEct to set the mode.</p>
Couplings	<p>This command is an alias to</p> <p>[:SENSe]:ACPower:OFFSet[1]2:LIST:FILTer[:RRC][:STATe]</p> <p>Sending the commands to set values of all offsets for BS and MS, however, sending the query always return a value of BS Offset A.</p>
Preset	<p>SA, WIMAX OFDMA, LTE, LTETDD, MSR: OFF</p> <p>WCDMA: ON</p> <p>C2K: NO</p> <p>TD-SCDMA: ON</p> <p>DVB-T/H: OFF</p> <p>DTMB (CTTB):ON</p> <p>ISDB-T: OFF</p> <p>CMMB: OFF</p> <p>Digital Cable TV: ON</p>
State Saved	Saved in instrument state.
Backwards Compatibility SCPI	<p>[:SENSe]:ACPR:FILTer[:RRC][:STATe]</p> <p>[:SENSe]:MCPower:FILTer[:RRC][:STATe]</p>
Initial S/W Revision	Prior to A.02.00
Modified at S/W Revision	A.03.00

Offset Filter Alpha (Backward Compatibility SCPI)

Mode	SA, WCDMA, WIMAX OFDMA, TD-SCDMA, DVB-T/H, DTMB (CTTB), ISDB-T, CMMB, LTE, LTETDD, Digital Cable TV, MSR
Remote Command	<p>[:SENSe] :ACPower :FILTer [:RRC] :ALPHa <real></p> <p>[:SENSe] :ACPower :FILTer [:RRC] :ALPHa?</p>
Example	<p>ACP:FILT:ALPH 0.5</p> <p>ACP:FILT:ALPH?</p>

Notes	<p>This parameter is not available for cdma2000 and 1xEVDO</p> <p>The backwards Compatibility SCPI command, [:SENSe]:ACPR:FILTer[:RRC]:ALPHa, is provided to support same functionality as [:SENSe]:ACPr:FILTer[:RRC]:ALPHa (PSA W-CDMA, PSA cdma2000 and PSA 1xEVDO) due to ACPr node conflicts with ACPower node.</p> <p>You must be in the mode that includes ACP measurements to use this command. Use :INSTrument:SElect to set the mode.</p>
Couplings	<p>This command is an alias to</p> <p>[:SENSe]:ACPower:OFFSet[1] 2:LIST:FILTer:ALPHa</p> <p>Sending the commands to set values of all offsets for BS and MS, however, sending the query always return a value of BS Offset A.</p>
Preset	<p>SA, WCDMA, WIMAX OFDMA, TD-SCDMA, DVB-T/H, ISDB-T, CMMB, LTE, LTETDD, MSR: 0.22</p> <p>C2K: NO</p> <p>DTMB (CTTB): 0.05</p> <p>Digital Cable TV: 0.15</p>
State Saved	Saved in instrument state.
Min	0.01
Max	1.00
Backwards Compatibility SCPI	<p>[:SENSe]:ACPR:FILTer[:RRC]:ALPHa</p> <p>[:SENSe]:MCPower:FILTer[:RRC]:ALPHa</p>
Initial S/W Revision	Prior to A.02.00
Modified at S/W Revision	A.03.00

Method for Carrier (Backward Compatibility SCPI)

Mode	SA, WCDMA, WIMAX OFDMA, TD-SCDMA, DVB-T/H, DTMB (CTTB), ISDB-T, CMMB, LTE, LTETDD, Digital Cable TV, MSR
Remote Command	<p>[:SENSe] :ACPower :CARRier[1] 2 :LIST :METHod IBW RRC, ...</p> <p>[:SENSe] :ACPower :CARRier[1] 2 :LIST :METHod?</p>
Example	<p>ACP:CARR2:LIST:METH RRC</p> <p>ACP:CARR2:LIST:METH?</p>
Notes	<p>You must be in the mode that includes ACP measurements to use this command. Use :INSTrument:SElect to set the mode.</p> <p>Maximum of Array length depends on the number of carriers.</p>

ACP Measurement
Meas Setup

Couplings	<p>This command is an alias to [:SENSe]:ACPower:CARRier[1] 2:LIST:FILTer[:RRC][:STATe]</p> <p>The enum value translates as follows: RRC Weighted = 1 ON Integ BW = 0 OFF Maximum of Array length depends on the number of carriers.</p>
Preset	<p>SA: IBW WCDMA: RRC WIMAX OFDMA: IBW TD-SCDMA: RRC DVB-T/H: IBW DTMB (CTTB): RRC ISDB-T: IBW CMMB: IBW LTE, MSR: IBW LTETDD: IBW Digital Cable TV: RRC</p>
State Saved	Saved in instrument state.
Initial S/W Revision	Prior to A.02.00
Modified at S/W Revision	A.03.00

Mode

See “Mode” on page 1534 for more information.

Key Path	Front-panel key
Initial S/W Revision	Prior to A.02.00

Mode Setup

See “[Mode Setup](#)” on page 1553 for more information.

Key Path	Front-panel key
Initial S/W Revision	Prior to A.02.00

Peak Search

Accesses a menu that enables you to control the peak search function.

Key Path	Front-panel key
Initial S/W Revision	Prior to A.02.00

Peak Search

Places the selected marker on the trace point with the maximum y-axis value.

Key Path	Peak Search
Mode	SA, WCDMA, C2K, WIMAX OFDMA, TD-SCDMA, 1xEVDO, DVB-T/H, DTMB (CTTB), ISDB-T, CMMB, LTE, LTETDD, Digital Cable TV, MSR
Remote Command	:CALCulate:ACPower:MARKer[1] 2 3 4 5 6 7 8 9 10 11 12:MAXimum
Example	CALC:ACP:MARK2:MAX
Initial S/W Revision	Prior to A.02.00
Modified at S/W Revision	A.02.00, A.03.00

Next Peak

Moves the selected marker to the peak that has the next highest amplitude.

Key Path	Peak Search
Mode	SA, WCDMA, C2K, WIMAX OFDMA, TD-SCDMA, 1xEVDO, DVB-T/H, DTMB (CTTB), ISDB-T, CMMB, LTE, LTETDD, Digital Cable TV, MSR
Remote Command	:CALCulate:ACPower:MARKer[1] 2 3 4 5 6 7 8 9 10 11 12:MAXimum:NEXT
Example	CALC:ACP:MARK2:MAX:NEXT
Initial S/W Revision	Prior to A.02.00
Modified at S/W Revision	A.02.00, A.03.00

Next Pk Right

Moves the selected marker to the nearest peak to the right of the current marker that meets all enabled peak criteria.

Key Path	Peak Search
----------	--------------------

ACP Measurement
Peak Search

Mode	SA, WCDMA, C2K, WIMAX OFDMA, TD-SCDMA, 1xEVDO, DVB-T/H, DTMB (CTTB), ISDB-T, CMMB, LTE, LTETDD, Digital Cable TV, MSR
Remote Command	:CALCulate:ACPower:MARKer[1] 2 3 4 5 6 7 8 9 10 11 12:MAXimum:RIGHT
Example	CALC:ACP:MARK2:MAX:RIGH
Initial S/W Revision	Prior to A.02.00
Modified at S/W Revision	A.02.00, A.03.00

Next Pk Left

Moves the selected marker to the nearest peak to the left of the current marker that meets all enabled peak criteria.

Key Path	Peak Search
Mode	SA, WCDMA, C2K, WIMAX OFDMA, TD-SCDMA, 1xEVDO, DVB-T/H, DTMB (CTTB), ISDB-T, CMMB, LTE, LTETDD, Digital Cable TV, MSR
Remote Command	:CALCulate:ACPower:MARKer[1] 2 3 4 5 6 7 8 9 10 11 12:MAXimum:LEFT
Example	CALC:ACP:MARK2:MAX:LEFT
Initial S/W Revision	Prior to A.02.00
Modified at S/W Revision	A.02.00, A.03.00

Marker Delta

Sets the control mode for the selected marker to Delta mode.

See Marker Delta in the "Marker Functions" section for more information.

Key Path	Peak Search
Initial S/W Revision	Prior to A.02.00

Pk-Pk Search

Finds and displays the amplitude and frequency (or time, if in zero span) differences between the highest and lowest y-axis value.

Key Path	Peak Search
Mode	SA, WCDMA, C2K, WIMAX OFDMA, TD-SCDMA, 1xEVDO, DVB-T/H, DTMB (CTTB), ISDB-T, CMMB, LTE, LTETDD, Digital Cable TV, MSR
Remote Command	:CALCulate:ACPower:MARKer[1] 2 3 4 5 6 7 8 9 10 11 12:PTPeak

Example	CALC:ACP:MARK:PTP
Notes	Turns on the Marker Δ active function.
Couplings	This key is not available (key is grayed out) when Coupled Markers is on.
Initial S/W Revision	Prior to A.02.00
Modified at S/W Revision	A.02.00, A.03.00

Min Search

Moves the selected marker to the minimum y-axis value on the current trace.

Key Path	Peak Search
Mode	SA, WCDMA, C2K, WIMAX OFDMA, TD-SCDMA, 1xEVDO, DVB-T/H, DTMB (CTTB), ISDB-T, CMMB, LTE, LTETDD, Digital Cable TV, MSR
Remote Command	:CALCulate:ACPower:MARKer[1] 2 3 4 5 6 7 8 9 10 11 12:M INimum
Example	CALC:ACP:MARK:MIN
Initial S/W Revision	Prior to A.02.00
Modified at S/W Revision	A.02.00, A.03.00

Recall

See “Recall” on page 194 for more information.

Key Path	Front-panel key
Initial S/W Revision	Prior to A.02.00

Restart

See “Restart” on page 1558 for more information.

Key Path	Front-panel key
Initial S/W Revision	Prior to A.02.00

Save

See “[Save](#)” on page 207 for more information.

Key Path	Front-panel key
Initial S/W Revision	Prior to A.02.00

Single

See “[Single \(Single Measurement/Sweep\)](#)” on page 1563 for more information.

Key Path	Front-panel key
Initial S/W Revision	Prior to A.02.00

Source

See “Source” on page 1564 for more information.

Key Path	Front-panel key
Initial S/W Revision	Prior to A.02.00

SPAN X Scale

Accesses a menu of functions that enable you set the horizontal scale parameters.

Key Path	Front-panel key
Initial S/W Revision	Prior to A.02.00

Span

Changes the frequency range symmetrically about the center frequency.

The default (and minimum) span is calculated using the number of carriers and the carrier width where;

$$\text{Span} = (\text{Upper Carrier Freq} + (\text{max offset IBW} * (1 + \alpha)) / 2) - (\text{Lower Carrier Freq} - (\text{max offset IBW} * (1 + \alpha)) / 2)$$

The span is increased by a factor of 1 + Filter Alpha if the RRC Filter is on.

Key Path	SPAN X Scale
Mode	SA, WCDMA, C2K, WIMAX OFDMA, TD-SCDMA, 1xEVDO, DVB-T/H, DTMB (CTTB), ISDB-T, CMMB, LTE, LTETDD, Digital Cable TV, MSR
Remote Command	[:SENSe] :ACPpower :FREQuency :SPAN <freq> [:SENSe] :ACPpower :FREQuency :SPAN?
Example	ACP:FREQ:SPAN 25MHz ACP:FREQ:SPAN?
Notes	You must be in the mode that includes ACP measurements to use this command. Use :INSTrument:SElect to set the mode.
Couplings	The span value is clipped when the carrier settings and/or the offset settings are changed. The value is changed to satisfy following formula: Span = (Upper Carrier Freq + (max offset IBW * (1 + alpha)) / 2) - (Lower Carrier Freq - (max offset IBW * (1 + alpha)) / 2)

ACP Measurement
SPAN X Scale

Preset	SA: 8 MHz WCDMA: 24.6848 MHz WiMAX OFDMA: 50 MHz C2K: 4.5 MHz TD-SCDMA: 8 MHz 1xEVDO: 4.05 MHz DVB-T/H: 40 MHz DTMB (CTTB): 72 MHz ISDB-T: 30 MHz CMMB: 72 MHz LTE, LTETDD, MSR: 25 MHz Digital Cable TV: 40 MHz
State Saved	Saved in instrument state.
Min	10 Hz
Max	Hardware Dependent: Option 503 = 3.7 GHz Option 507 = 7.1 GHz Option 508 = 8.5 GHz Option 513 = 13.8 GHz Option 526 = 27.0 GHz
Initial S/W Revision	Prior to A.02.00
Modified at S/W Revision	A.02.00, A.03.00

Full Span

Changes the span to show the full frequency range of the spectrum analyzer.

Key Path	SPAN X Scale
Mode	SA, WCDMA, C2K, WiMAX OFDMA, TD-SCDMA, 1xEVDO, DVB-T/H, DTMB (CTTB), ISDB-T, CMMB, LTE, LTETDD, Digital Cable TV
Remote Command	[:SENSe] :ACPpower:FREQuency:SPAN:FULL
Example	ACP:FREQ:SPAN:FULL
Notes	You must be in the mode that includes ACP measurements to use this command. Use :INSTrument:SElect to set the mode.
Dependencies	For MSR mode, this key is blank.
Initial S/W Revision	Prior to A.02.00

Modified at S/W Revision	A.02.00, A.03.00
--------------------------	------------------

Last Span

Changes the span to the previous span setting. If no previous span value exists, then the span will remain unchanged.

Key Path	SPAN X Scale
Mode	SA, WCDMA, C2K, WIMAX OFDMA, TD-SCDMA, 1xEVDO, DVB-T/H, DTMB (CTTB), ISDB-T, CMMB, LTE, LTETDD, Digital Cable TV, MSR
Remote Command	[:SENSe] :ACPower :FREQuency :SPAN :PREVious
Example	ACP:FREQ:SPAN:PREV
Notes	You must be in the mode that includes ACP measurements to use this command. Use :INSTrument:SELEct to set the mode.
Initial S/W Revision	Prior to A.02.00
Modified at S/W Revision	A.02.00, A.03.00

Sweep/Control

Accesses a menu of functions that enable you to set up and control the sweep time, and source.

See “Sweep/Control” on page 1564 for more information.

Key Path	Front-panel key
Initial S/W Revision	Prior to A.02.00

Sweep Time

Selects the length of time in which the spectrum analyzer sweeps the displayed frequency span. In swept spans, the sweep time varies from 1 millisecond to 2000 seconds. Additional overhead time, which impacts the sweep rate, is not calculated as part of the sweep time. In fact:

sweep rate = span/sweep time

update rate = 1/(sweep time + overhead)

sweep cycle time = sweep time + overhead

Sweep time is coupled to RBW and VBW, and is impacted by the number of sweep points, so changing those parameters may change the sweep time.

If you increase the sweep time, you increase the length of the time data captured and the number of points measured. You might need to specify a specific sweep speed to accommodate a specific condition in your transmitter. For example, you may have a burst signal and need to measure an exact portion of the burst.

Selecting a specific sweep time may result in a long measurement time since the resulting number of data points may not be the optimum. Use [:SENSE]:ACP:OFFSet:LIST:SWEep:TIME to set the number of points used for measuring the offset channels for Basic and cdmaOne.

For cdma2000 and W-CDMA, this command sets the sweep time when using the sweep mode. See [:SENSE]:ACP:SWEep:TYPE

Key Path	Sweep/Control
Mode	SA, WCDMA, C2K, WIMAX OFDMA, TD-SCDMA, 1xEVDO, DVB-T/H, DTMB (CTTB), ISDB-T, CMMB, LTE, LTETDD, Digital Cable TV, MSR
Remote Command	<pre>[:SENSE]:ACP:Power:SWEep:TIME <time> [:SENSE]:ACP:Power:SWEep:TIME? [:SENSE]:ACP:Power:SWEep:TIME:AUTO OFF ON 0 1 [:SENSE]:ACP:Power:SWEep:TIME:AUTO?</pre>

Example	ACP:SWE:TIME 50ms ACP:SWE:TIME? ACP:SWE:TIME:AUTO OFF ACP:SWE:TIME:AUTO?
Notes	This parameter is preset by Meas Method selection. Preset values are as follows: IBW: 29 ms IBWR: 108 ms FAST (WCDMA): 7.5 ms
Couplings	When you manually change the Sweep Time, this state automatically goes to 'Man'.
Preset	SA, LTE, LTETDD, MSR: Automatically calculated WCDMA: 29 ms WIMAX OFDMA: Automatically calculated C2K: Automatically calculated TD-SCDMA: Automatically calculated 1xEVDO: Automatically calculated DVB-T/H: Automatically calculated DTMB (CTTB): Automatically calculated ISDB-T: Automatically calculated CMMB: Automatically calculated Digital Cable TV: Automatically calculated SA, LTE, LTETDD, MSR: ON WCDMA: OFF C2K: OFF (method IBW) WIMAX OFDMA: ON TD-SCDMA: ON DVB-T/H: ON DTMB (CTTB): ON ISDB-T: ON CMMB: ON Digital Cable TV: ON
State Saved	Saved in instrument state.
Min	1 ms
Max	4000 s

ACP Measurement Sweep/Control

Initial S/W Revision	Prior to A.02.00
Modified at S/W Revision	A.02.00, A.03.00

Sweep Setup

Accesses the sweep setup menu.

Key Path	Sweep/Control
Initial S/W Revision	Prior to A.02.00

Auto Sweep Time Rules

Switches the analyzer between normal and accuracy sweep states.

Key Path	Sweep/Control, Sweep Setup
Mode	SA, WCDMA, C2K, WIMAX OFDMA, TD-SCDMA, 1xEVDO, DVB-T/H, DTMB (CTTB), ISDB-T, CMMB, LTE, LTETDD, Digital Cable TV, MSR
Remote Command	[:SENSe] :ACPoweR :SWEep :TIME :AUTO :RULes NORMal ACCuracy [:SENSe] :ACPoweR :SWEep :TIME :AUTO :RULes?
Example	ACP:SWE:TIME:AUTO:RUL NORM ACP:SWE:TIME:AUTO:RUL?
Notes	Set to Norm when Auto Couple is pressed or sent remotely.
Preset	SA, WCDMA, C2K, TD-SCDMA, 1xEVDO, DTMB (CTTB), LTE, LTETDD, MSR: ACCuracy WIMAX OFDMA, DVB-T/H: NORMal ISDB-T, CMMB: NORMal Digital Cable TV: NORMal
State Saved	Saved in instrument state.
Range	Norm Accy
Initial S/W Revision	Prior to A.02.00
Modified at S/W Revision	A.02.00, A.03.00

Pause

Pauses a measurement after the current data acquisition is complete. When Paused, the label on the key changes to Resume. Pressing the Resume key resumes the measurement at the point where it was paused. When Paused, pressing **Restart**, **Single**, or **Cont** does a Resume

See “Pause/Resume” on page 1577 in “Common Measurement Functions” for more details.

Key Path	Sweep/Control
Initial S/W Revision	Prior to A.02.00

Gate

Accesses a menu that enables you to control the gating function. The Gate functionality is used to view signals best viewed by qualifying them with other events.

Gate Method that lets you choose one of the three different types of gating is not available in this measurement.

See “Gate ” on page 1578 for more details.

Key Path	Sweep/Control
Initial S/W Revision	Prior to A.02.00

Points

Sets the number of points per sweep, from 1 to 20001. The sweep time resolution setting will depend on the number of points selected.

Key Path	Sweep/Control
Mode	SA, WCDMA, C2K, WIMAX OFDMA, TD-SCDMA, 1xEVDO, DVB-T/H, DTMB (CTTB), ISDB-T, CMMB, LTE, LTETDD, Digital Cable TV, MSR
Remote Command	[:SENSe] :ACPower :SWEep :POINts <integer> [:SENSe] :ACPower :SWEep :POINts?
Example	ACP:SWE:POIN 500 ACP:SWE:POIN?
Notes	Whenever the number of sweep points changes: <ul style="list-style-type: none"> • All trace data is erased • Any traces with Update Off will also go to Display Off (like going from View to Blank in the older analyzers) • Sweep time is re-quantized • Any limit lines that are on will be updated • If averaging/hold is on, averaging/hold starts over
Couplings	Whenever the number of sweep points changes, the sweep time is re-quantized.

ACP Measurement
Sweep/Control

Preset	Others: 1001 DVB-T/H:2001 DTMB (CTTB): 2001 ISDB-T: 2001 CMMB: 2001 Digital Cable TV: 2001
State Saved	Saved in instrument state.
Min	1
Max	20001
Initial S/W Revision	Prior to A.02.00
Modified at S/W Revision	A.02.00, A.03.00

Trace/Detector

Accesses a menu of functions that enable you to control the detectors for the current measurement.

Key Path	Front-panel key
Initial S/W Revision	Prior to A.02.00

Select Trace (Front-panel Only)

This key selects which trace the other parameters under the Trace/Detector menu will apply to.

Key Path	Trace/Detector
Notes	Front-panel only.
Couplings	When Meas Method is RBW or FAST, Select Trace is disabled.
Preset	1
State Saved	Saved in instrument state.
Range	1 2 3
Initial S/W Revision	Prior to A.02.00

Trace Type

Allows you to select the type of trace for the current measurement. The first page of this menu contains a selection of the trace type (Clear Write, Trace Average, Max Hold, Min Hold) for the selected trace.

Key Path	Trace/Detector
Mode	SA, WCDMA, C2K, WIMAX OFDMA, TD-SCDMA, 1xEVDO, DVB-T/H, DTMB (CTTB), ISDB-T, CMMB, LTE, LTETDD, Digital Cable TV, MSR
Remote Command	:TRACe[1] 2 3:ACPpower:TYPE WRITe AVERAge MAXHold MINHold :TRACe[1] 2 3:ACPpower:TYPE?
Example	TRAC:ACP:TYPE MINH TRAC:ACP:TYPE?
Notes	WRITe = Clear Write AVERAge = Average MAXHold = Maximum Hold MINHold = Minimum Hold

ACP Measurement
Trace/Detector

Couplings	When Detector setting is “Auto” ([:SENSe]:ACPower:DETECTOR:AUTO?), Detector is set to what the Radio Standard defaults states (see detector section below) for all conditions of Trace Type and for all traces. When set to Manual, all Traces use the same detector type. When Average State = Off then Trace Types AVERage, MaxHold and MinHold will not function, since Averaging is required to be ‘on’ for them to operate. When Meas Method is RBW or FAST, Trace Type is disabled.
Preset	AVERage
State Saved	Saved in instrument state.
Initial S/W Revision	Prior to A.02.00
Modified at S/W Revision	A.02.00, A.03.00

View / Blank

Enables you to select how to view the displayed trace.

Key Path	Trace/Detector
Mode	SA, WCDMA, C2K, WIMAX OFDMA, TD-SCDMA, 1xEVDO, DVB-T/H, DTMB (CTTB), ISDB-T, CMMB, LTE, LTETDD, Digital Cable TV, MSR
Notes	No . remote control. Front panel only.
Couplings	The four states of this 1-of-N actually set two variables, Update and Display, to their four possible combinations. Trace On: Update and Display both On View: Update Off and Display On (Not implemented) Blank: Update Off and Display Off Background: Update On, Display Off (Not implemented) See tables below for detail on remote commands to control these two variables. Selecting a trace type (Clear Write, Trace Average, Max Hold, Min Hold) for a trace (pressing the key or sending the equivalent remote command) puts the trace in ‘Trace On’ state (Update On and Display On), even if that trace type was already selected. When Meas Method is RBW or FAST, this key is grayed out.
Preset	Trace On
State Saved	Saved in instrument state.
Range	Trace On Blank
Initial S/W Revision	Prior to A.02.00
Modified at S/W Revision	A.03.00

Key Path	Trace/Detector
----------	----------------

Mode	WCDMA, C2K, WIMAX OFDMA, TD-SCDMA, 1xEVDO, DVB-T/H, DTMB (CTTB), ISDB-T, CMMB, LTE, LTETDD, Digital Cable TV, MSR
Remote Command	:TRACe[1] 2 3:ACPpower:UPDate[:STATe] ON OFF 0 1 :TRACe[1] 2 3:ACPpower:UPDate[:STATe]?
Example	TRAC:ACP:UPD ON TRAC:ACP:UPD?
Couplings	Whenever you set Update to On for any trace, the Display is set to On for that trace. When Meas Method is RBW or FAST, Trace Update is disabled.
Preset	1 0 0 (On for Trace 1; Off for 2 &3)
State Saved	Saved in instrument state.
Range	0 1
Initial S/W Revision	Prior to A.02.00
Modified at S/W Revision	A.03.00

Key Path	Trace/Detector
Mode	WCDMA, C2K, WIMAX OFDMA, TD-SCDMA, 1xEVDO, DVB-T/H, DTMB (CTTB), ISDB-T, CMMB, LTE, LTETDD, Digital Cable TV, MSR
Remote Command	:TRACe[1] 2 3:ACPpower:DISPlay[:STATe] ON OFF 0 1 :TRACe[1] 2 3:ACPpower:DISPlay[:STATe]?
Example	TRAC:ACP:DISP ON TRAC:ACP:DISP?
Couplings	Whenever you set Update to On for any trace, the Display is set to On for that trace. When Meas Method is RBW or FAST, Trace Display is disabled.
Preset	1 0 0 (On for Trace 1; Off for 2 &3)
State Saved	Saved in instrument state.
Range	0 1
Initial S/W Revision	Prior to A.02.00
Modified at S/W Revision	A.03.00

Detector

Accesses a menu of functions that enables you to control the detectors for the current measurement. Allows up to three (3) traces, but each use the same detector type choice. The following choices are available:

ACP Measurement
Trace/Detector

- Auto- the detector selected is set to AVERage, unless the Radio Standard defaults state otherwise e.g. it is set to Peak for Radio Standard = PDC when Device = both MS and BTS, and when Radio Standard = NADC and Device = MS.
- Normal-the detector determines the peak of the CW-like signals, and it yields alternating maximums and minimums of noise-like signals. This is also referred to as Rosenfell detection.
- Average-the detector determines the average of the signal within the sweep points. The averaging method is Power (RMS).
- Peak-the detector determines the maximum of the signal within the sweep points.
- Sample-the detector indicates the instantaneous level of the signal at the center of the sweep points represented by each display point.
- Negative Peak-the detector determines the minimum of the signal within the sweep points.

In swept analysis, the time interval of the data collection for the display sweep points also represents a frequency interval. In FFT analysis, the sweep points represents just a frequency interval. The detector determines the relationship between the spectrum computed by the FFT and the single data point displayed for the sweep points.

Key Path	Trace/Detector
Initial S/W Revision	Prior to A.02.00

Auto

Sets the detector for the currently selected trace to auto.

Key Path	Trace/Detector
Mode	SA, WCDMA, C2K, WIMAX OFDMA, TD-SCDMA, 1xEVDO, DVB-T/H, DTMB (CTTB), ISDB-T, CMMB, LTE, LTETDD, Digital Cable TV, MSR
Remote Command	[:SENSe] :ACPpower:DETECTOR:AUTO ON OFF 1 0 [:SENSe] :ACPpower:DETECTOR:AUTO?
Example	ACP:DET:AUTO 1 ACP:DET?
Couplings	When Detector setting is “Auto” ([:SENSe] :ACPpower:DETECTOR:AUTO?), Detector is set to what the Radio Standard defaults states (see detector section) for all conditions of Trace Type and for all traces. When set to Manual, all Traces use the same detector type. When Average State = Off then Trace Types AVERage, MaxHold and MinHold will not function, since Averaging is required to be ‘on’ for them to operate.
Preset	ON
State Saved	Saved in instrument state.
Range	ON OFF
Initial S/W Revision	Prior to A.02.00

Modified at S/W Revision	A.02.00, A.03.00
--------------------------	------------------

Detector Selection

Selects a detector to be used by the analyzer for the current measurement. All traces will use the same detector type, similar to Monitor Spectrum measurement

Key Path	Trace/Detector
Mode	SA, WCDMA, C2K, WIMAX OFDMA, TD-SCDMA, 1xEVDO, DVB-T/H, DTMB (CTTB), ISDB-T, CMMB, LTE, LTETDD, Digital Cable TV, MSR
Remote Command	[:SENSe]:ACPoweR:DETEctor[:FUNctIon] AVERAge NEGAtive NORMAl POSitive SAMPle [:SENSe]:ACPoweR:DETEctor[:FUNctIon]?
Example	ACP:DET NORM ACP:DET?
Notes	<p>When you manually select a detector (instead of selecting Auto), that detector is used regardless of other analyzer settings.</p> <p>The detector choices are:</p> <ul style="list-style-type: none"> • The Normal detector determines the peak of CW-like signals, and it yields alternating maximums and minimums of noise-like signals. This is also referred to as Rosenfell detection. • The Average detector determines the average of the signal within the data range. The averaging method is Power (RMS). • The Peak detector determines the maximum of the signal within the data range. • The Sample detector indicates the instantaneous level of the signal at the center of the data represented by each display point. • The Negative Peak detector determines the minimum of the signal within the data range. <p>Because they may not find a spectral component's true peak, neither average nor sample detectors measure amplitudes of CW signals as accurately as peak or normal, but they do measure noise without the biases of peak detection.</p> <p>When a detector selection is made, the menu returns to the previous menu.</p>
Couplings	<p>When Detector setting is "Auto" (:SENSe]:ACPoweR:DETEctor:AUTO?), Detector is set to what the Radio Standard defaults states (see detector section) for all conditions of Trace Type and for all traces. When set to Manual, all Traces use the same detector type. When Average State = Off then Trace Types AVERAge, MaxHold and MinHold will not function, since Averaging is required to be 'on' for them to operate.</p> <p>Only one detector type for all 3 traces is allowed.</p> <p>When Meas Method is RBW or FAST, Detector is disabled.</p>
Preset	AVERAge

ACP Measurement
Trace/Detector

State Saved	Saved in instrument state.
Range	Normal Average Peak Sample Negative Peak
Backwards Compatibility SCPI	[:SENSe]:ACPR:SWEep:DETEctor[:FUNction]
Initial S/W Revision	Prior to A.02.00
Modified at S/W Revision	A.02.00, A.03.00

Trigger

Accesses a menu functions that enable you to select and control the trigger source for the current measurement. See [“Trigger” on page 1595](#) for more information.

Key Path	Front-panel key
Initial S/W Revision	Prior to A.02.00

View/Display

Accesses a menu of functions that enable you to control the instrument display as well as turn the bar graph On and Off.

If current mode is NOT MSR mode, the front panel views only contain one view: Spectrum View.

The results of the measurement can be displayed as a single spectrum trace view or displayed with a Bar Graph trace on the spectrum trace.

The display consists of the following two windows:

“Spectrum Window” on page 570

“Results Window” on page 570

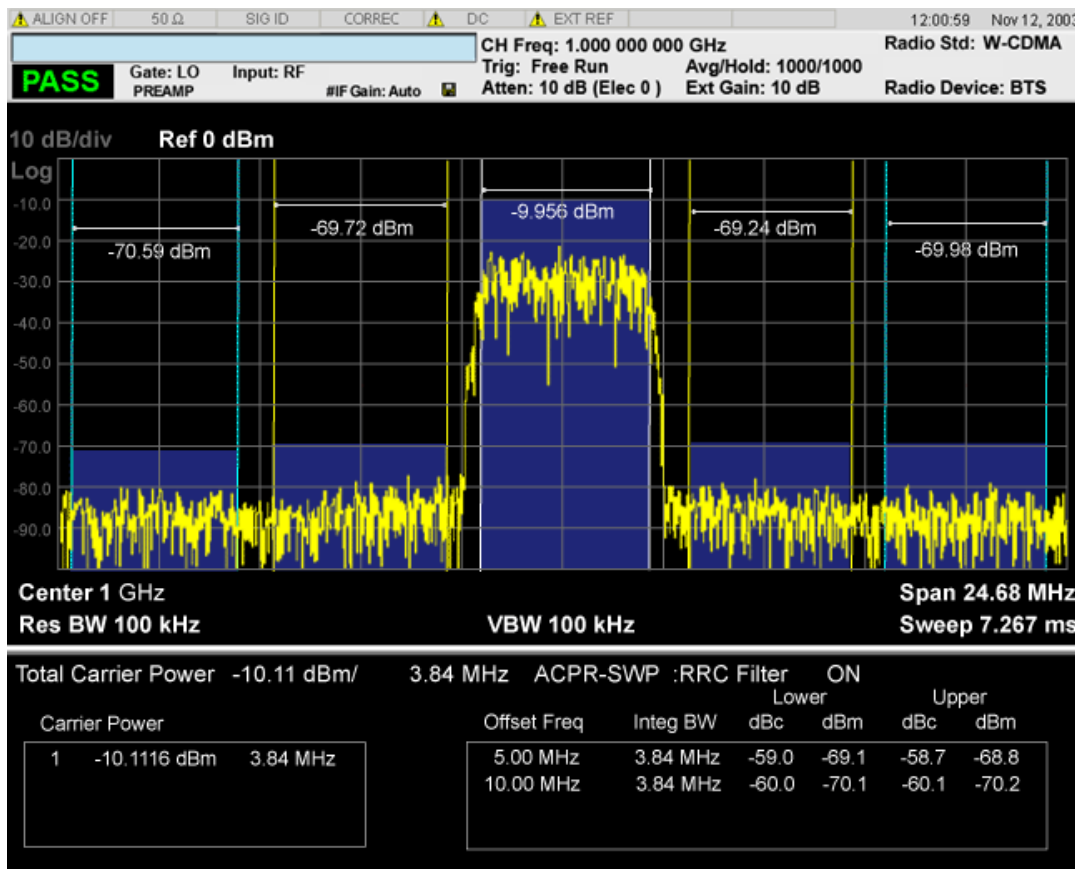

The following two views are only for DTMB (CTTB) and CMMB:

DTMB and CMMB Transmitter:

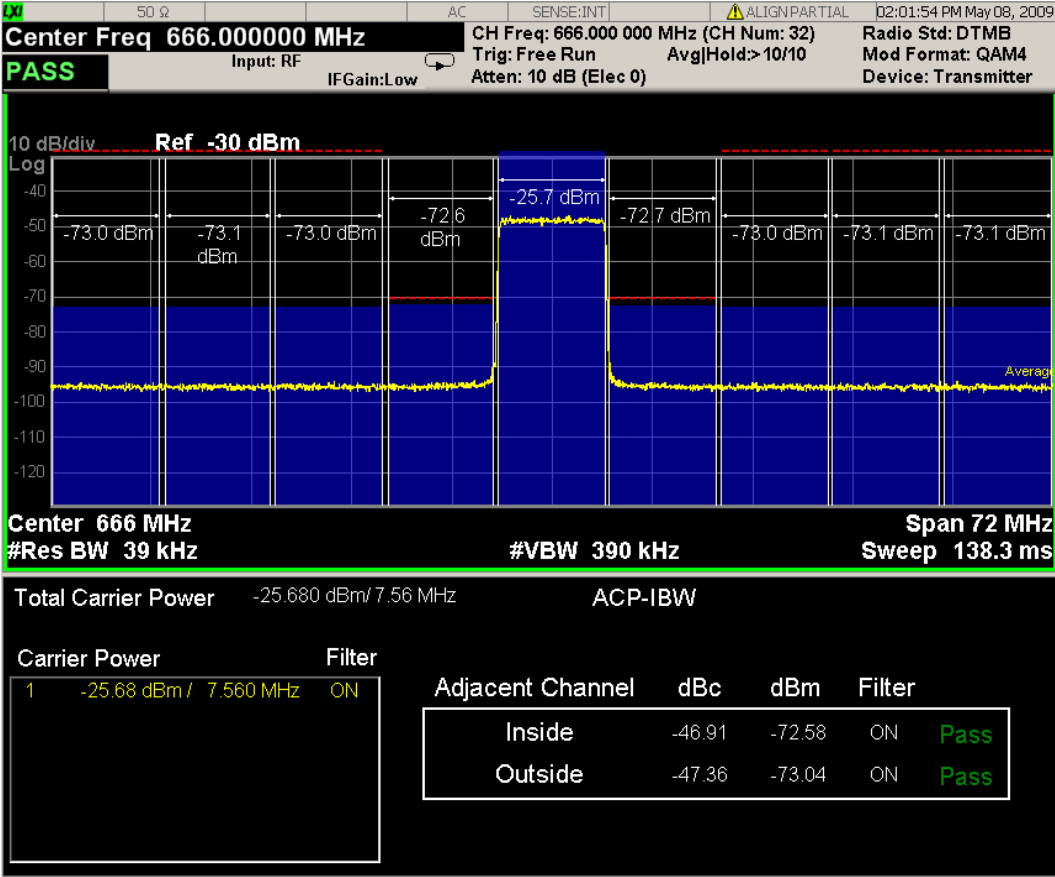

DTMB and CMMB Exciter:

ACP Measurement
View/Display

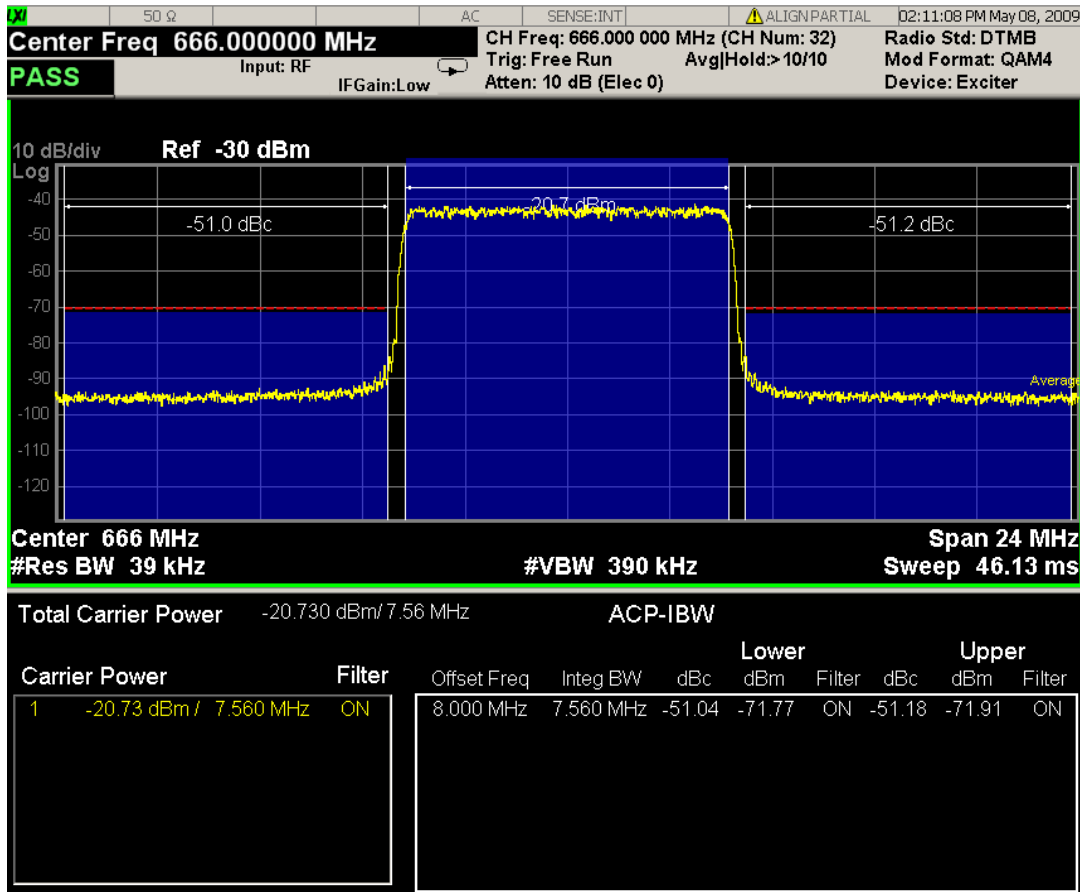

Spectrum Window

When the Bar Graph is On and Limit Test is On, the color of each bar graph reflects the limit test result. When the limit test fails, the bar color is red, and when limit test passes, the bar color is blue.

When RBW is selected as the measurement method, the spectrum trace is not displayed, only the bar graph is displayed. In addition, the Bar Graph key (under the View/Display front-panel key) is set to ON and is grayed out.

The RRC Filter display item is only displayed when RRC filter is on.

Results Window

The text window displays the following results:

Total Carrier Power

This is the total power of all the carriers with carrier power present set to yes. The power is calculated by integrating across the bandwidth declared by the Carrier Integ Bw parameter for each carrier and then totaling the sums. The total integration bandwidth is shown as part of the result. This will be the total of the Carrier Integ Bw of the carriers used in calculating the total carrier power. If the RRC Filter is on, then the integration bandwidth used is $(1 + \alpha)/T$ where $T = 1/(\text{Carrier Integ Bw})$ multiplied by the number of carriers with carrier power present set to yes.

Ref Carrier Power

This is the power in the reference carrier. The power is calculated by integrating across the bandwidth declared by the Carrier Integ Bw parameter for that carrier. The integration bandwidth is shown as part of the result. This is the value of the Carrier Integ Bw for that carrier unless the RRC Filter is on, then the integration bandwidth used is the displayed value, which is $(1 + \alpha)/T$ where $T = 1/(\text{Carrier Integ Bw})$.

Carrier Power

This is the power in all the currently defined carriers. If the carrier has carrier power present, the power will be absolute. If the carrier is defined as not having power present, the power will be relative to the reference carrier. The power is calculated by integrating across the bandwidth declared by the Carrier Integ Bw parameter. The integration bandwidth is shown as part of the result. This is the value of the Carrier Integ Bw for the carrier unless the RRC Filter is on, then the integration bandwidth used is the displayed value, which is $(1 + \alpha)/T$ where $T = 1/(\text{Carrier Integ Bw})$.

As there are potentially more results than can be easily viewed on the display, a scrollable list is used to display all results. The Carrier Results menu key is used to index the carrier amplitude results. This key is grayed out unless the measurement is in single mode (as in continual measurement mode). The display is continuously updating and will not need to be accessed. The currently selected Carrier Result is displayed on the last line of the carrier power result list unless:

- The selected Carrier Result is 4 or less in normal multi carrier power results view. In this case the first 4 carrier power results will be displayed.
- The selected Carrier Result is 9 or greater in normal multi carrier power results view. In this case the last 4 carrier power results will be displayed.
- The zoom mode is selected. In this case all carrier power ranges can be displayed.

Offset Relative Power

This is the power in the offsets relative to the reference carrier. The power is calculated by integrating across the bandwidth declared by the Offset Integ Bw parameter. The offset integration bandwidth is shown as part of the result. This is the value on the Offset Integ Bw menu key unless the RRC Filter is on, then the integration bandwidth used is the displayed value, which is $(1 + \alpha)/T$ where $T = 1/(\text{Offset Integ Bw})$.

Offset Absolute Power

This is the absolute power in the offsets. The power is calculated by integrating across the bandwidth declared by the Offset Integ Bw parameter. The offset integration bandwidth is shown as part of the result. This is the value on the Offset Integ Bw menu key unless the RRC Filter is on, then the integration bandwidth used is the displayed value, which is $(1 + \alpha)/T$ where $T = 1/(\text{Offset Integ Bw})$.

Inside Adjacent Channel Power (DTMB (CTTB) and CMMA only)

This result is only valid for DTMB (CTTB) transmitter and CMMA transmitter. It contains two parts: Relative Power and Absolute Power. The power is calculated by integrating across the bandwidth (Integ Bw) at the frequency Offset A.

$$\text{Inside Absolute Power} = \text{MAX} (P_{\text{Lower Offset A}}, P_{\text{Upper Offset A}});$$

$$\text{Inside Relative Power} = \text{Inside Absolute Power} - \text{Carrier Power};$$

Outside Adjacent Channel Absolute Power (DTMB (CTTB) and CMMA only)

ACP Measurement
View/Display

This result is only valid for DTMB (CTTB) transmitter and CMMB transmitter. It contains two parts: Relative Power and Absolute Power. The power is the Root-Mean-Square of the power calculated by integrating across the bandwidth (Integ Bw) at frequency Offset B, C and D.

$$\text{Outside Absolute Power} = \sqrt{\frac{P_{\text{Lower OffsetB}}^2 + P_{\text{Upper OffsetB}}^2 + P_{\text{Lower OffsetC}}^2 + P_{\text{Upper OffsetC}}^2 + P_{\text{Lower OffsetD}}^2 + P_{\text{Upper OffsetD}}^2}{6}}$$

Outside Relative Power = Outside Absolute Power – Carrier Power;

If current mode is MSR, there are two views, Result Trace and Carrier Info.

View Selection by Name (MSR Only)

Selects the results view. The following SCPI command allows you to select the desired measurement view by enumeration.

Key Path	No equivalent front-panel key
Mode	MSR
Remote Command	:DISPlay:ACPower:VIEW[:SElect] PRESult CINformation :DISPlay:ACPower:VIEW[:SElect]?
Example	DISP:ACP:VIEW PRES DISP:ACP:VIEW?
Notes	This SCPI is only available in MSR.
Preset	PRESult
State Saved	Saved in instrument state
Range	Power Results Carrier Info
Initial S/W Revision	A.10.00

Key Path	No equivalent front-panel key
Mode	MSR
Remote Command	:DISPlay:ACPower:VIEW:NSElect <integer> :DISPlay:ACPower:VIEW:NSElect?
Example	DISP:ACP:VIEW:NSEL 1 DISP:ACP:VIEW:NSEL?
Notes	This SCPI is only available in MSR.
Preset	1
State Saved	Saved in instrument state
Min	1

Max	2
Initial S/W Revision	A.10.00

Key Path	Front-panel key
Initial S/W Revision	Prior to A.02.00

Display

Accesses a menu of functions that enable you to set the display parameters.

See “[Display](#)” on page 1646 for more information.

Key Path	View/Display
Initial S/W Revision	Prior to A.02.00

Result Trace (MSR Only)

The spectrum trace and power bars are displayed in the upper window. Carrier and offset powers are summarized in the lower window. See “[Spectrum Window](#)” on page 570 and “[Results Window](#)” on page 570 for more information.

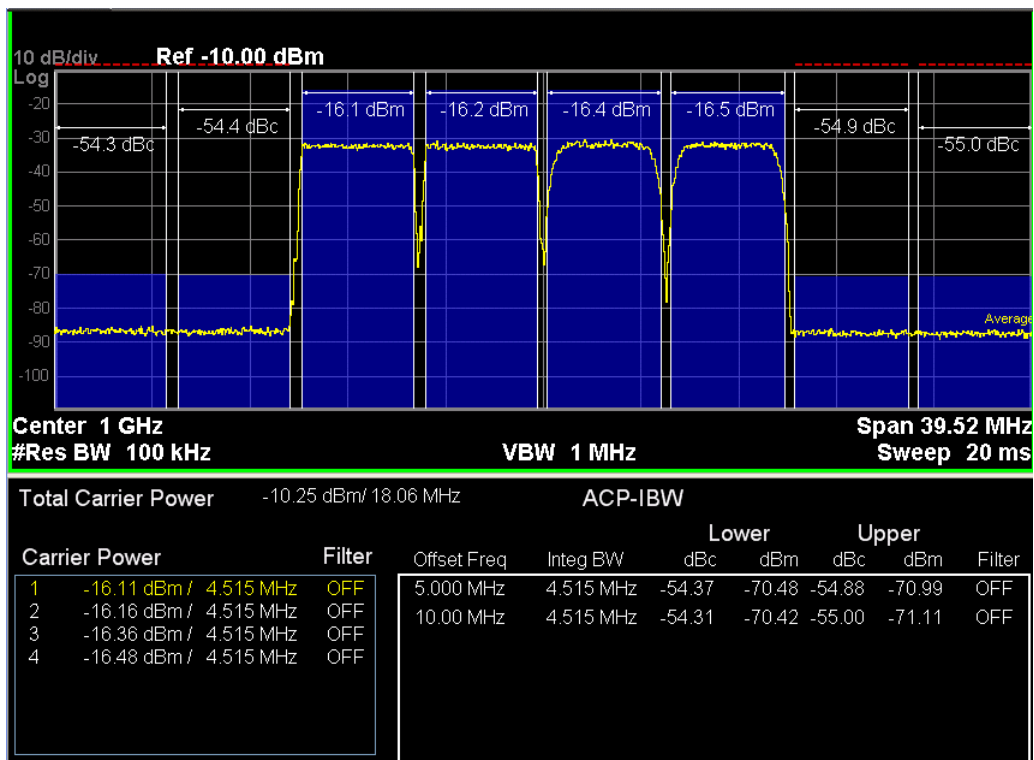

Key Path	View/Display
----------	---------------------

Initial S/W Revision	A.10.00
----------------------	---------

Carrier Info (MSR Only)

The lower window of Power Results view is replaced by the carrier info table in this view. Carrier center frequency can be displayed in either offset or absolute frequency depending on Carrier Freq. The table can be scrolled by Carrier Result on Meas Setup menu or by Select Carrier on Config Carriers menu. The highlighted row changes as either Carrier Result or Select Carrier is changed. The highlighted row and these keys are not coupled.

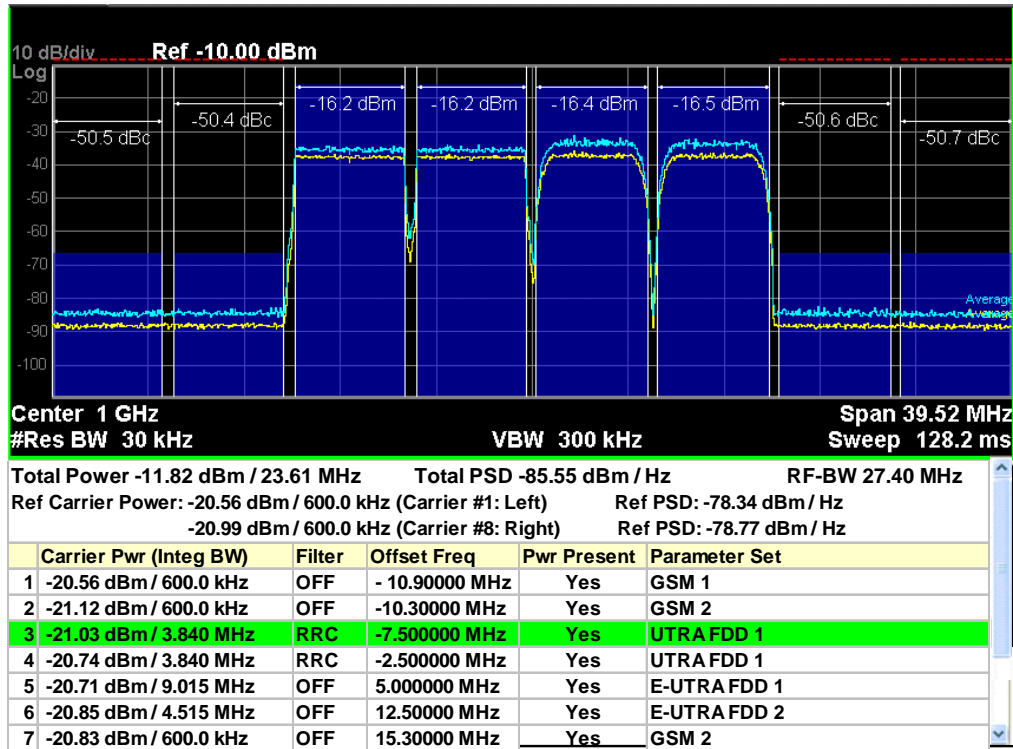

Carrier Pwr (Integ BW)		Filter	Offset Freq	Pwr Present	Parameter Set
1	-20.56 dBm / 600.0 kHz	OFF	-10.90000 MHz	Yes	GSM 1
2	-21.12 dBm / 600.0 kHz	OFF	-10.30000 MHz	Yes	GSM 2
3	-21.03 dBm / 3.840 MHz	RRC	-7.500000 MHz	Yes	UTRA FDD 1
4	-20.74 dBm / 3.840 MHz	RRC	-2.500000 MHz	Yes	UTRA FDD 1
5	-20.71 dBm / 9.015 MHz	OFF	5.000000 MHz	Yes	E-UTRA FDD 1
6	-20.85 dBm / 4.515 MHz	OFF	12.50000 MHz	Yes	E-UTRA FDD 2
7	-20.83 dBm / 600.0 kHz	OFF	15.30000 MHz	Yes	GSM 2
8	-20.99 dBm / 600.0 kHz	OFF	15.90000 MHz	Yes	GSM 1

Key Path	View/Display
Initial S/W Revision	A.10.00

Carrier Freq (MSR Only)

Sets the carrier frequency display type.

Offset - The carrier center frequencies are displayed as offset from Carrier Ref Freq.

Absolute - The carrier center frequencies are displayed as absolute frequency.

Key Path	View/Display, Carrier Info
Mode	MSR
Remote Command	:DISPlay:ACPower:VIEW:WINDow:CINFormation:FREQuency OFFSet ABSolute :DISPlay:ACPower:VIEW:WINDow:CINFormation:FREQuency?
Example	DISP:ACP:VIEW:WIND:CINF:FREQ ABS DISP:ACP:VIEW:WIND:CINF:FREQ?
Notes	This key is blank in mode other than MSR.
Preset	OFFSet
State Saved	Saved in instrument state

ACP Measurement
View/Display

Range	Offset Absolute
Initial S/W Revision	A.10.00

Bar Graph

Turns the Bar Graph On and Off.

Key Path	View/Display
Mode	SA, WCDMA, C2K, WIMAX OFDMA, TD-SCDMA, 1xEVDO, DVB-T/H, DTMB (CTTB), ISDB-T, CMMB, LTE, LTETDD, Digital Cable TV, MSR
Remote Command	:DISPlay:ACPower:VIEW[1]:WINDow[1]:BGRaph OFF ON 0 1 :DISPlay:ACPower:VIEW[1]:WINDow[1]:BGRaph?
Example	DISP:ACP:VIEW:WIND:BGR OFF DISP:ACP:VIEW:WIND:BGR?
Notes	You must be in the mode that includes ACP measurements to use this command. Use :INSTrument:SELEct to set the mode.
Dependencies	When the method is RBW, this key is always set to On and grayed out.
Preset	ON
State Saved	Saved in instrument state.
Range	On Off
Initial S/W Revision	Prior to A.02.00
Modified at S/W Revision	A.02.00, A.03.00

Many of the digitally modulated signals now look noise-like in the time and frequency domain. This means that statistical measurements of the signals can be a useful characterization. The Power Complementary Cumulative Distribution Function (CCDF) curves characterize the higher level power statistics of a digitally modulated signal. The curves can be useful in determining design parameters for digital communications systems. For more information, see [“Power Stat CCDF Measurement Description” on page 579](#). For measurement results and views, see [“View/Display” on page 615](#).

For information on how to make measurement using the X-Series Signal Analyzer, see:

Measurement Guide [n9080-90006.pdf].

This topic contains the following sections:

[“Measurement Commands for Power Stat CCDF” on page 577](#)

[“Remote Command Results for Power Stat CCDF” on page 578](#)

Measurement Commands for Power Stat CCDF

The general functionality of CONFigure, FETCh, MEASure, and READ are described at the beginning of this section. See the SENSE:PStat commands for more measurement related commands.

:CONFigure:PStatistic

:CONFigure:PStatistic:NDEFault

:INITiate:PStatistic

:FETCh:PStatistic[n]?

:READ:PStatistic[n]?

:MEASure:PStatistic[n]?

For more measurement related commands, see the SENSE subsystem, and the section [“Remote Measurement Functions” on page 1520](#).

Remote Command Results for Power Stat CCDF

n	Results Returned
0	Returns unprocessed I/Q trace data, as a series of trace point values, in volts. The I values are listed first in each pair, using the 0 through even-indexed values. The Q values are the odd-indexed values,
not specified or 1	Returns 10 scalar results: <ol style="list-style-type: none"> 1. Average input power (in dBm) 2. Probability at the average input power level (in %) 3. Power level that has 10% of the power 4. Power level that has 1% of the power 5. Power level that has 0.1% of the power 6. Power level that has 0.01% of the power 7. Power level that has 0.001% of the power 8. Power level that has 0.0001% of the power 9. Peak power (in dB) 10.Count
2	Returns a series of 5001 floating point numbers (in percent) that represent the current measured power stat trace. This is the probability at particular power levels (average power), in the following order: <ol style="list-style-type: none"> 1. Probability at 0.0 dB power 2. Probability at 0.01 dB power 3. Probability at 0.02 dB power ... 5000. Probability at 49.9 dB power 5001. Probability at 50.0 dB power
3	Returns a series of 5001 floating point numbers (in percent) that represent the Gaussian trace. This is the probability at particular power levels (average power), in the following order: <ol style="list-style-type: none"> 1. Probability at 0.0 dB power 2. Probability at 0.01 dB power 3. Probability at 0.02 dB power ... 5000. Probability at 49.9 dB power 5001. Probability at 50.0 dB power

4	<p>Returns a series of 5001 floating point numbers (in percent) that represent the user-definable reference trace. This is the probability at particular power levels (average power), in the following order:</p> <ol style="list-style-type: none"> 1. Probability at 0.0 dB power 2. Probability at 0.01 dB power 3. Probability at 0.02 dB power ... 5000. Probability at 49.9 dB power 5001. Probability at 50.0 dB power
---	--

Power Stat CCDF Measurement Description

The power statistics CCDF measurement can be affected by many factors. For example, modulation filtering, modulation format, combining the multiple signals at different frequencies, number of active codes, and correlation between symbols on different codes with spread spectrum systems will all affect measurement results. These factors are all related to modulation and signal parameters. External factors such as signal compression and expansion by nonlinear components, group delay distortion from filtering, and power control within the observation interval also affect the measurement.

The power measured in power statistics CCDF curves is actually instantaneous envelope power defined by the equation:

$$P = (I^2 + Q^2) / Z_0$$

(Where I&Q are the quadrature voltage components of the waveform and Z_0 is the characteristic impedance).

A CCDF curve is defined by how much time the waveform spends at or above a given power level. The percent of time the signal spends at or above the level defines the probability for that particular power level. For capturing a lower probability down to 0.0001%, this measurement is made in the single mode by pressing Single. To make the power statistics CCDF measurement, the instrument uses digital signal processing (DSP) to sample the input signal in the channel bandwidth. The Gaussian distribution line as the band-limited Gaussian noise CCDF reference line, the user-definable reference trace, and the currently measured trace can be displayed on a semi-log graph. If the currently measured trace is above the user reference trace, it means that the higher peak power levels against the average power are included in the input signal.

Key Path	Meas
Initial S/W Revision	Prior to A.02.00

AMPTD Y Scale

Accesses a menu of functions that enable you to set the vertical scale parameters. The parameter values are measurement independent except all Attenuation values, and the Internal Preamp selection, which are the same across all measurements.

Key Path	Front-panel key
Initial S/W Revision	Prior to A.02.00

Attenuation

Accesses a menu of functions that enable you to change the attenuation settings. This key has read-back text that describes the total attenuator value.

See AMPTD Y Scale, “[Attenuation](#)” on page 1381 for more information.

This is only available when the selected input is RF.

Key Path	AMPTD Y Scale
Initial S/W Revision	Prior to A.02.00

Range

Accesses the Range menu to change baseband I/Q gain settings. This key has a readback text that describes gain range value. Refer to “[Range](#)” on page 1390 for more information.

Key Path	AMPTD Y Scale
Initial S/W Revision	Prior to A.02.00

Presel Center

When this key is pressed, the centering of the preselector filter is adjusted to optimize the amplitude accuracy at the frequency of the selected marker.

See AMPTD Y Scale, “[Presel Center](#)” on page 1396 for more information.

This is only available when the selected input is RF.

Key Path	AMPTD Y Scale
Initial S/W Revision	Prior to A.02.00

Presel Adjust

Allows you to manually adjust the preselector filter frequency to optimize its response to the signal of interest. This function is only available when Presel Center is available.

See AMPTD Y Scale, “[Preselector Adjust](#)” on page 1398 for more information.

This is only available when the selected input is RF.

Key Path	AMPTD Y Scale
Initial S/W Revision	Prior to A.02.00

Y Axis Unit

Allows you to change the vertical (Y) axis amplitude unit.

See “[Y Axis Unit](#)” on page 1399 under AMPTD Y Scale for more information.

Key Path	AMPTD Y Scale
Initial S/W Revision	A.04.00

Reference Level Offset

Adds an offset value to the displayed reference level. The reference level is the absolute amplitude represented by the top graticule line on the display.

See “[Reference Level Offset](#)” on page 1404 under AMPTD Y Scale for more information.

Key Path	AMPTD Y Scale
Initial S/W Revision	A.04.00

μW Path Control

The **μW Path Control** functions include the **μW Preselector Bypass** (Option MPB) and **Low Noise Path** (Option LNP) controls in the High Band path circuits.

See μ“[μW Path Control](#) ” on page 1405 under AMPTD Y Scale for more information.

Key Path	AMPTD Y Scale
Initial S/W Revision	A.04.00

Internal Preamp

Accesses a menu of functions that enable you to control the internal preamplifiers.

See AMPTD Y Scale, “[Internal Preamp](#)” on page 1410 for more information.

This is only available when the selected input is RF.

Key Path	AMPTD Y Scale
Initial S/W Revision	Prior to A.02.00

Auto Couple

See “Auto Couple” on page 1412 for more information.

Key Path	Front-panel key
Initial S/W Revision	Prior to A.02.00

BW

Opens the BW menu, which contains keys to control the information bandwidth functions of the instrument.

Key Path	Front-panel key
Initial S/W Revision	Prior to A.02.00

Info BW

Allows you to enter a frequency value to set the channel bandwidth that will be used for data acquisition.

Key Path	BW
Mode	SA, WCDMA, C2K, WIMAXOFDMA, TD-SCDMA, 1xEV-DO, DVB-T/H, DTMB (CTTB), ISDB-T, CMMB, LTE, LTETDD, Digital Cable TV, WLAN, MSR
Remote Command	[:SENSe]:PStatistic:BANDwidth <freq> [:SENSe]:PStatistic:BANDwidth?
Example	PST:BAND 8 MHz PST:BAND?
Couplings	WiMAX OFDMA: The default value depends on the Radio Standard selection..

Power Stat CCDF Measurement
BW

Preset	<p>SA, WCDM: 5 MHz</p> <p>C2K: 1.5 MHz</p> <p>1xEV-DO: 1.3 MHz</p> <p>WiMAX OFDMA: Hardware Dependent</p> <p>No Option = 10 MHz</p> <p>WB (25 MHz or wider) = 25 MHz</p> <p>TD-SCDMA: 1.3 MHz</p> <p>DVB-T/H, DTMB (CTTB): 8 MHz</p> <p>ISDB-T: 6 MHz</p> <p>CMMB: 8 MHz</p> <p>LTE, LTETDD: 6 MHz</p> <p>Digital Cable TV: 8MHz</p> <p>WLAN: Hardware Dependent</p> <p>No option = 10 MHz</p> <p>Option B25 = 25 MHz</p> <p>WB(40MHz or wider):</p> <p>if Radio Std is 802.11a/b/g/n(20MHz) = 25 MHz</p> <p>if Radio Std is 802.11n(40MHz) = 40 MHz</p> <p>MSR: same as max value</p>
State Saved	Saved in instrument state.
Min	10.0 kHz
Max	<p>Hardware Dependent:</p> <p>RF Input:</p> <p>No Option = 10 MHz</p> <p>WB (25MHz or wider) = Hardware Option Limit</p> <p>I/Q Input (for I+jQ):</p> <p>No Option = 20 MHz</p> <p>Option B25 = 50 MHz</p>
Backwards Compatibility SCPI	[:SENSe]:PStatistic:BWIDth
Initial S/W Revision	Prior to A.02.00
Modified at S/W Revision	A.02.00, A.03.00, A.06.00

Cont

See “[Cont \(Continuous Measurement/Sweep\)](#)” on page 1413 for more information.

Key Path	Front-panel key
Initial S/W Revision	Prior to A.02.00

FREQ Channel

See “[FREQ Channel](#)” on page 1414 for more information.

Key Path	Front-panel key
Initial S/W Revision	Prior to A.02.00

Input/Output

See [“Input/Output” on page 1422](#) for more information.

Key Path	Front-panel key
Initial S/W Revision	Prior to A.02.00

Marker

Accesses a menu that enables you to select, set up and control the markers for the current measurement.

Key Path	Front-panel key
Initial S/W Revision	Prior to A.02.00

Select Marker

Accesses a menu that allows you to select one of 12 markers for control and function

Key Path	Marker
Initial S/W Revision	Prior to A.02.00

Marker Type

Sets the marker control mode to **Normal**, **Delta**, **Fixed** or **Off**.

If the selected marker is Off, pressing Marker sets it to Normal and places it at the center of the screen on the trace determined by the **Marker Trace** rules. At the same time, **Marker X Axis Value** appears on the Active Function area.

The Active function for the selected marker's current control mode is the default active function. If the current control mode is Off, there is no active function and the active function is turned off. The active function display is the marker X axis value entered in the active function area will display the marker value to its full entered precision.

All interactions and dependencies detailed under the key description are enforced when the remote command is sent.

Key Path	Marker
Mode	SA, WCDMA, C2K, WiMAX OFDMA, TD-SCDMA, 1xEV-DO, DVB-T/H, DTMB (CTTB), ISDB-T, CMMB, LTE, LTETDD, Digital Cable TV, WLAN, MSR
Remote Command	:CALCulate:PStatistic:MARKer[1] 2 3 4 5 6 7 8 9 10 11 12:MODE POSition DELTA OFF :CALCulate:PStatistic:MARKer[1] 2 3 4 5 6 7 8 9 10 11 12:MODE?
Example	CALC:PST:MARK:MODE POS CALC:PST:MARK:MODE?

Notes	<p>If the selected marker is Off, pressing Marker sets it to Normal and places it at the center of the screen on the trace determined by the Marker Trace rules. At the same time, Marker X Axis Value appears on the Active Function area.</p> <p>Default Active Function: the active function for the selected marker's current control mode. If the current control mode is Off, there is no active function and the active function is turned off.</p> <p>Active Function Display: the marker X axis value entered in the active function area will display the marker value to its full entered precision.</p>
Preset	OFF
State Saved	Saved in instrument state.
Range	Normal Delta Off
Initial S/W Revision	Prior to A.02.00
Modified at S/W Revision	A.02.00, A.03.00

Marker X Axis Value (Remote Command Only)

Sets the marker X Axis value in the current marker X Axis Scale unit. This function has no effect if the control mode is **Off**, but is the remote command equivalent of entering an X value if the control mode is **Normal** or **Delta**.

Mode	SA, WCDMA, C2K, WIMAXOFDMA, TD-SCDMA, 1xEV-DO, DVB-T/H, DTMB (CTTB), ISDB-T, CMMB, LTE, LTETDD, Digital Cable TV, WLAN, MSR
Remote Command	<pre>:CALCulate:PStatic:MARKer[1] 2 3 4 5 6 7 8 9 10 11 12:X <rel_ampl></pre> <pre>:CALCulate:PStatic:MARKer[1] 2 3 4 5 6 7 8 9 10 11 12:X?</pre>
Example	<pre>CALC:PST:MARK3:X 0</pre> <pre>CALC:PST:MARK3:X?</pre>
Notes	<p>If no suffix is sent, it will use the fundamental units for the current marker X Axis Scale. If a suffix is sent that does not match the current marker X Axis Scale unit, an error "Invalid suffix" will be generated. If the specified marker is Fixed and a Marker Function is on, error -221 "Settings conflict; cannot adjust Fixed marker while Marker Function is on" is generated.</p> <p>The query returns the marker's absolute X Axis value if the control mode is Normal, or the offset from the marker's reference marker if the control mode is Delta. The query is returned in the fundamental units for the current marker X Axis scale: Hz for Frequency and Inverse Time, seconds for Period and Time. If the marker is Off the response is not a number.</p>
Preset	After a preset, all Markers are turned OFF, so Marker X Axis Value query will return a not a number (NAN).
State Saved	No

Min	-9.9E+37
Max	9.9E+37
Initial S/W Revision	Prior to A.02.00
Modified at S/W Revision	A.02.00, A.03.00

Marker Y Axis Value (Remote Command Only)

Queries the marker Y Axis value in the current marker Y Axis unit.

Mode	SA, WCDMA, C2K, WIMAXOFDMA, TD-SCDMA, 1xEV-DO, DVB-T/H, DTMB (CTTB), ISDB-T, CMMB, LTE, LTETDD, Digital Cable TV, WLAN, MSR
Remote Command	:CALCulate:PStatistic:MARKer[1] 2 3 4 5 6 7 8 9 10 11 12:Y?
Example	CALC:PST:MARK11:Y?
Notes	The query returns the marker Y-axis result, if the control mode is Normal , or Delta . If the marker is Off the response is not a number.
Preset	0
State Saved	No
Backwards Compatibility SCPI	:CALCulate:PStatistic:MARKer[1] 2 3 4 5 6 7 8 9 10 11 12:FUNCTion:RESul t?
Initial S/W Revision	Prior to A.02.00
Modified at S/W Revision	A.02.00, A.03.00

Properties

Accesses the marker properties menu.

Key Path	Marker
Initial S/W Revision	Prior to A.02.00

Select Marker

Accesses a menu that allows you to select one of 12 markers for control and function

Key Path	Marker, Properties
Initial S/W Revision	Prior to A.02.00

Relative To

Sets the reference marker that the selected marker will be relative to.

Key Path	Marker, Properties
Mode	SA, WCDMA, C2K, WIMAXOFDMA, TD-SCDMA, 1xEV-DO, DVB-T/H, DTMB (CTTB), ISDB-T, CMMB, LTE, LTETDD, Digital Cable TV, WLAN, MSR
Remote Command	:CALCulate:PStatistic:MARKer[1] 2 3 4 5 6 7 8 9 10 11 12:REFerence <integer> :CALCulate:PStatistic:MARKer[1] 2 3 4 5 6 7 8 9 10 11 12:REFerence?
Example	CALC:PST:MARK:REF 3 CALC:PST:MARK:REF?
Notes	A marker cannot be relative to itself so that choice is grayed out, and if sent from SCPI generates error -221: "Settings conflict; marker cannot be relative to itself." When queried a single value will be returned (the specified marker numbers relative marker).
Preset	2 3 4 5 6 7 8 9 10 11 12 1
State Saved	Saved in instrument state.
Min	1
Max	12
Initial S/W Revision	Prior to A.02.00
Modified at S/W Revision	A.02.00, A.03.00

Marker Trace

Assigns the specified marker to the designated trace. The trace choices are: Measured, Gaussian, or Reference.

Key Path	Marker
Mode	SA, WCDMA, C2K, WIMAXOFDMA, TD-SCDMA, 1xEV-DO, DVB-T/H, DTMB (CTTB), ISDB-T, CMMB, LTE, LTETDD, Digital Cable TV, WLAN, MSR
Remote Command	:CALCulate:PStatistic:MARKer[1] 2 3 4 5 6 7 8 9 10 11 12:TRACe MEASured GAUSSian REFerence :CALCulate:PStatistic:MARKer[1] 2 3 4 5 6 7 8 9 10 11 12:TRACe?
Example	CALC:PST:MARK3:TRAC MEAS CALC:PST:MARK:TRACE?

Power Stat CCDF Measurement
Marker

Preset	MEASured
State Saved	Saved in instrument state.
Range	Measured Gaussian Reference
Initial S/W Revision	Prior to A.02.00
Modified at S/W Revision	A.02.00, A.03.00

Couple Markers

When this function is On, moving any marker causes an equal X axis movement of every other marker which is not **Off**. By “equal X axis movement” we mean that we preserve the difference between each marker’s X axis value (in the fundamental x-axis units of the trace that marker is on) and the X axis value of the marker being moved (in the same fundamental x-axis units).

Key Path	Marker
Initial S/W Revision	Prior to A.02.00

All Markers Off

Turns off all markers.

Key Path	Marker, More
Mode	SA, WCDMA, C2K, WIMAXOFDMA, TD-SCDMA, 1xEV-DO, DVB-T/H, DTMB (CTTB), ISDB-T, CMMB, LTE, LTETDD, Digital Cable TV, WLAN, MSR
Remote Command	:CALCulate:PSTatistic:MARKer:AOFF
Example	CALC:PST:MARK:AOFF
Initial S/W Revision	Prior to A.02.00
Modified at S/W Revision	A.02.00, A.03.00

Marker Function

There are no ‘Marker Functions’ supported in Power Stat CCDF measurement. The front-panel key will display a blank key menu when pressed.

Key Path	Front-panel key
Initial S/W Revision	Prior to A.02.00

Marker To

There is no 'Marker To' functionality supported in Power Stat CCDF measurement. The front-panel key will display a blank key menu when pressed.

Key Path	Front-panel key
Initial S/W Revision	Prior to A.02.00

Meas

See “Meas” on page 1520 for more information.

Key Path	Front-panel key
Initial S/W Revision	Prior to A.02.00

Meas Setup

Accesses the functions that allow you to change the settings for your measurement requirements.

Key Path	Front-panel key
Initial S/W Revision	Prior to A.02.00

Counts

Sets the accumulated number of sampling points for data acquisition. The range is 1.000 kpt (k point) to 2.00000 Gpt (G point) with 1 kpt resolution. Counts couples to Meas Cycles. When the value for counts is changed, the Meas Cycles value will be $(Counts / SamplingFrequency * MeasInterval)$.

Key Path	Meas Setup
Mode	SA, WCDMA, C2K, WIMAXOFDMA, TD-SCDMA, 1xEV-DO, DVB-T/H, DTMB (CTTB), ISDB-T, CMMB, LTE, LTETDD, Digital Cable TV, WLAN, MSR
Remote Command	[:SENSe]:PStatistic:COUNTs <integer> [:SENSe]:PStatistic:COUNTs?
Example	PST:COUN 5001 PST:COUN?
Couplings	This value is coupled to Meas Cycles. When Counts is changed, the MeasCycles value will be $(Counts / SamplingFrequency * MeasInterval)$. TD-SCDMA: When Counts is changed, the MeasCycles value will be $(Counts / (Sampling Frequency * Time duration of measured time slots / 5 msec))$, Time duration of measured time slots is determined by Analysis Time Slot and Measure Interval.
Preset	10000000
State Saved	Saved in instrument state.
Min	1000
Max	2000000000
Default Unit	Kpt
Initial S/W Revision	Prior to A.02.00
Modified at S/W Revision	A.02.00, A.03.00

Meas Cycles

Set the number of measurement cycles to calculate power statistic data. This number couples to Counts. The Counts value is $(MeasCycles * Sampling Frequency * MeasInterval)$.

When the counts value cannot be divided by (Sampling Frequency * MeasInterval), this value is displayed as a decimal fraction.

Key Path	Meas Setup
Mode	SA, WCDMA, C2K, WiMAX OFDMA, TD-SCDMA, 1xEV-DO, DVB-T/H, DTMB (CTTB), ISDB-T, CMMB, LTE, LTETDD, Digital Cable TV, WLAN, MSR
Remote Command	[:SENSe]:PStatistic:SWEep:CYCLes <integer> [:SENSe]:PStatistic:SWEep:CYCLes?
Example	PST:SWE:CYCL 1001 PST:SWE:CYCL?
Notes	.
Couplings	The Counts value will be (MeasCycles * Sampling Frequency * MeasInterval). TD-SCDMA: The Counts value will be (MeasCycles * Sampling Frequency * Time duration of measured time slots / 5 msec), Time duration of measured time slots is determined by Analysis Time Slot and Measure Interval.
Preset	Depends on the sampling frequency.
Min	1
Max	Depends on the sampling frequency.
Initial S/W Revision	Prior to A.02.00
Modified at S/W Revision	A.02.00, A.03.00

Meas Interval (When the application is NOT CDMA1xEVDO)

Sets the number of data points to be used as the measurement interval. This value couples to Counts. The Counts value is (MeasCycles * Sampling Frequency * MeasInterval).

Key Path	Meas Setup
Mode	SA, WCDMA, C2K, WiMAX OFDMA, TD-SCDMA, 1xEV-DO, DVB-T/H, DTMB (CTTB), ISDB-T, CMMB, LTE, LTETDD, Digital Cable TV, WLAN, MSR
Remote Command	[:SENSe]:PStatistic:SWEep:TIME <time> [:SENSe]:PStatistic:SWEep:TIME?
Example	PST:SWE:TIME 2 ms PST:SWE:TIME?

Power Stat CCDF Measurement
Meas Setup

Couplings	The Counts value will be (MeasCycles * Sampling Frequency * MeasInterval). WiMAX OFDMA: The default value depends on Radio Device status. TD-SCDMA: The Counts value will be (MeasCycles * Sampling Frequency * Time duration of measured time slots / 5 msec), Time duration of measured time slots is determined by Analysis Time Slot and Measure Interval. When TriggerSource is RFBurst, this button is grayed.
Preset	Others: 1.0 ms TD-SCDMA: 1 slot
Min	Others: 50.0 us TD-SCDMA: 1 slot
Max	Others: 10.0 ms TD-SCDMA: 9 slot
Initial S/W Revision	Prior to A.02.00
Modified at S/W Revision	A.02.00, A.03.00

Meas Interval (CDMA1xEVDO Only)

Sets the value of time to be used as the measurement interval. This value couples to Counts. The Counts value is (MeasCycles * Sampling Frequency * MeasInterval).

Key Path	Meas Setup
Mode	1xEV-DO
Remote Command	[:SENSE]:PStatistic:SWEep:TIME <time> [:SENSE]:PStatistic:SWEep:TIME?
Example	PST:SWE:TIME 2 ms PST:SWE:TIME?
Couplings	The Counts value will be (MeasCycles * Sampling Frequency * MeasInterval).
Preset	182.29 us
State Saved	Saved in instrument state.
Min	1.0 us
Max	10.0 ms
Initial S/W Revision	Prior to A.02.00

Meas Offset (CDMA1xEVDO Only)

Sets the value of time to be used as the measurement interval start.

Key Path	Meas Setup
Mode	CDMA1xEVDO
Remote Command	[:SENSe]:PStatistic:MEAS:OFFSet <time> [:SENSe]:PStatistic:MEAS:OFFSet?
Example	PST:SWE:OFFS 2 ms PST:SWE:OFFS?
Preset	325.52 us
State Saved	Saved in instrument state.
Min	1.0 us
Max	10.0 ms
Initial S/W Revision	Prior to A.02.00

IF Gain

Sets the IF Gain function to Auto, Low Gain or High Gain. These settings affect sensitivity and IF overloads.

This only applies to the RF input. It does not apply to baseband I/Q input.

Key Path	Meas Setup
Initial S/W Revision	Prior to A.02.00

IF Gain Auto

Activates the Auto Rules for IF Gain When Auto is active, the IF Gain is set to High Gain under any of the following conditions:

- the input attenuator is set to 0 dB
- the preamp is turned On
- the Max Mixer Level is -20 dBm or lower

For other settings, Auto sets IF Gain to Off.

Key Path	Meas Setup, IF Gain
Mode	SA, WCDMA, C2K, WiMAX OFDMA, TD-SCDMA, 1xEV-DO, DVB-T/H, DTMB (CTTB), ISDB-T, CMMB, LTE, LTE-TDD, Digital Cable TV, WLAN, MSR

Power Stat CCDF Measurement
Meas Setup

Remote Command	[:SENSe]:PStatistic:IF:GAIN:AUTO[:STATe] ON OFF 1 0 [:SENSe]:PStatistic:IF:GAIN:AUTO[:STATe]?
Example	PST:IF:GAIN:AUTO ON PST:IF:GAIN:AUTO?
Notes	IF Gain only applies to the RF input. It does not apply to baseband I/Q input.
Couplings	When either the auto attenuation is active (for example, with electrical attenuator), or the optimize mechanical attenuator range is requested, the IF Gain setting is changed using the following rule. The Auto selection sets IF Gain On under any of the following conditions: <ul style="list-style-type: none"> • the input attenuator is set to 0 dB • the preamp is turned on, • the Max Mixer Level is –20 dBm or lower. For other settings, Auto sets IF Gain to Off.
Preset	OFF
State Saved	Saved in instrument state.
Range	Auto Man
Initial S/W Revision	Prior to A.02.00
Modified at S/W Revision	A.02.00, A.03.00

IF Gain State

Selects the range of IF gain. On sets the high gain option, which allows for better noise level measurements and Off sets low gain when measuring large signals.

Key Path	Meas Setup, IF Gain
Mode	SA, WCDMA, C2K, WIMAXOFDMA, TD-SCDMA, 1xEV-DO, DVB-T/H, DTMB (CTTB), ISDB-T, CMMB, LTE, LTETDD, Digital Cable TV, WLAN, MSR
Remote Command	[:SENSe]:PStatistic:IF:GAIN[:STATe] ON OFF 1 0 [:SENSe]:PStatistic:IF:GAIN[:STATe]?
Example	PST:IF:GAIN ON PST:IF:GAIN?
Notes	IF Gain only applies to the RF input. It does not apply to baseband I/Q input. where ON = high gain OFF = low gain
Preset	OFF

State Saved	Saved in instrument state.
Range	Low Gain (Best for Large Signals) High Gain (Best Noise Level)
Readback Text	Low Gain High Gain
Initial S/W Revision	Prior to A.02.00
Modified at S/W Revision	A.02.00, A.03.00

Meas Preset

Restores all measurement settings to their default values.

Key Path	Meas Setup
Mode	SA, WCDMA, C2K, WIMAXOFDMA, TD-SCDMA, 1xEV-DO, DVB-T/H, DTMB (CTTB), ISDB-T, CMMB, LTE, LTETDD, Digital Cable TV, WLAN, MSR
Remote Command	:CONFigure:PStatistic
Example	CONF:PST
Notes	You must be in the Spectrum Analysis mode, W-CDMA mode, cdma2000 mode, TD-SCDMA mode, DVB-T/H mode, DTMB (CTTB) mode, ISDB-T mode, CMMB mode, Digital Cable TV mode or WIMAXOFDMA mode to use this command. Use :INSTrument:SElect to set the mode.
Couplings	Selecting Meas Preset will restore all measurement parameters to their default values.
Initial S/W Revision	Prior to A.02.00
Modified at S/W Revision	A.02.00, A.03.00

Mode

See “[Mode](#)” on page 1534 for more information.

Key Path	Front-panel key
Initial S/W Revision	Prior to A.02.00

Mode Setup

See “[Mode Setup](#)” on page 1553 for more information.

Key Path	Front-panel key
Initial S/W Revision	Prior to A.02.00

Peak Search

There is no 'Peak Search' functionality supported in Power Stat CCDF measurement. The front-panel key will display a blank key menu when pressed.

Key Path	Front-panel key
Initial S/W Revision	Prior to A.02.00

Recall

See “[Recall](#)” on page 194 for more information.

Key Path	Front-panel key
Initial S/W Revision	Prior to A.02.00

Restart

See “Restart” on page 1558 for more information.

Key Path	Front-panel key
Initial S/W Revision	Prior to A.02.00

Save

See [“Save” on page 207](#) for more information.

Key Path	Front-panel key
Initial S/W Revision	Prior to A.02.00

Single

See “[Single \(Single Measurement/Sweep\)](#)” on page 1563 for more information.

Key Path	Front-panel key
Initial S/W Revision	Prior to A.02.00

Source

See [“Source” on page 1564](#) for more information.

Key Path	Front-panel key
Initial S/W Revision	Prior to A.02.00

Span X Scale

The SPAN X Scale key accesses the menu to set the desired horizontal scale.

Key Path	Front-panel key
Initial S/W Revision	Prior to A.02.00

Scale/Div

Enables you to enter a time value to change the horizontal scale.

Key Path	Span X Scale
Mode	SA, WCDMA, C2K, WIMAXOFDMA, TD-SCDMA, 1xEV-DO, DVB-T/H, DTMB (CTTB), ISDB-T, CMMB, LTE, LTETDD, Digital Cable TV, WLAN, MSR
Remote Command	:DISPlay:PSTatistic:VIEW[1]:WINDow2:TRACe:X[:SCALE]:PDI Vision <rel_ampl> :DISPlay:PSTatistic:VIEW[1]:WINDow2:TRACe:X[:SCALE]:PDI Vision?
Example	DISP:PST:VIEW:WIND2:TRAC:X:PDIV 10 DISP:PST:VIEW:WIND2:TRAC:X:PDIV?
Notes	CCDF measurement has the trace display only at Window 2.
Couplings	See Notes
Preset	2.00
State Saved	Saved in instrument state.
Min	0.1
Max	20
Backwards Compatibility SCPI	:DISPlay:PSTatistic:XScale
Initial S/W Revision	Prior to A.02.00
Modified at S/W Revision	A.02.00, A.03.00

Sweep/Control

Enables you to pause the power statistics CCDF measurement after the current data acquisition is complete. When Paused, the label on the menu key changes to Resume. Press the Resume key to resume the measurement where it was when it was paused.

Key Path	Front-panel key
Initial S/W Revision	Prior to A.02.00

Pause/Resume

Pauses a measurement after the current data acquisition is complete. When Paused, the label on the key changes to Resume. Press the Resume key to resume the measurement where it was when it was paused. See [“Pause/Resume” on page 1577](#) for details.

Key Path	Sweep/Control
Initial S/W Revision	Prior to A.02.00

Trace/Detector

Accesses a menu of functions that enable you to control the storage and manipulation of the reference trace, as well as controls the display of the trace data.

Key Path	Front-panel key
Initial S/W Revision	Prior to A.02.00

Store Ref Trace

Copies the currently measured curve as the user-definable reference trace. The captured data remains until the other mode is chosen. Pressing this key also refreshes the reference trace.

No query command is available.

Key Path	Trace/Detector
Mode	SA, WCDMA, C2K, WIMAXOFDMA, TD-SCDMA, 1xEV-DO, DVB-T/H, DTMB (CTTB), ISDB-T, CMMB, LTE, LTETDD, Digital Cable TV, WLAN, MSR
Remote Command	:CALCulate:PSTatistic:STORe:REFerence
Example	CALC:PST:STOR:REF
Backwards Compatibility SCPI	[:SENSe]:PSTatistic:SRTRace
Initial S/W Revision	Prior to A.02.00
Modified at S/W Revision	A.02.00, A.03.00

Ref Trace

Toggles the reference trace display between On and Off.

Key Path	Trace/Detector
Mode	SA, WCDMA, C2K, WIMAXOFDMA, TD-SCDMA, 1xEV-DO, DVB-T/H, DTMB (CTTB), ISDB-T, CMMB, LTE, LTETDD, Digital Cable TV, WLAN, MSR
Remote Command	:DISPlay:PSTatistic:RTRace[:STATe] OFF ON 0 1 :DISPlay:PSTatistic:RTRace[:STATe]?
Example	DISP:PST:RTR OFF DISP:PST:RTR?
Preset	OFF
State Saved	Saved in instrument state.

Range	On Off
Backwards Compatibility SCPI	[:SENSe]:PSTatistic:RTRace[:STATe]
Initial S/W Revision	Prior to A.02.00
Modified at S/W Revision	A.02.00, A.03.00, A.04.00

Gaussian Line

Toggles the Gaussian trace display between On and Off.

Key Path	Trace/Detector
Mode	SA, WCDMA, C2K, WIMAXOFDMA, TD-SCDMA, 1xEV-DO, DVB-T/H, DTMB (CTTB), ISDB-T, CMMB, LTE, LTETDD, Digital Cable TV, WLAN, MSR
Remote Command	:DISPlay:PSTatistic:GAUSSian[:STATe] OFF ON 0 1 :DISPlay:PSTatistic:GAUSSian[:STATe]?
Example	DISP:PST:GAUS OFF DISP:PST:GAUS?
Preset	ON
State Saved	Saved in instrument state.
Range	On Off
Backwards Compatibility SCPI	[:SENSe]:PSTatistic:GAUSSian[:STATe]
Initial S/W Revision	Prior to A.02.00
Modified at S/W Revision	A.02.00, A.03.00, A.04.00

Trigger

Accesses a menu of functions that enable you to select and control the trigger source for the current measurement. .See [“Trigger” on page 1595](#) for more information.

Key Path	Front-panel key
Initial S/W Revision	Prior to A.02.00

View/Display

Accesses a menu of functions that enable you to control the instrument display as well as turn the bar graph On and Off.

The Power Stat CCDF measurement consists of single view. This is common for both Uplink (MS) and Downlink (BTS). The view consists of the following windows: Metrics (left) and graph display (right).

“Metrics window” on page 618

“Graph window” on page 618

“Wave window (TD-SCDMA and LTETDD only)” on page 618 and LTETDD only)

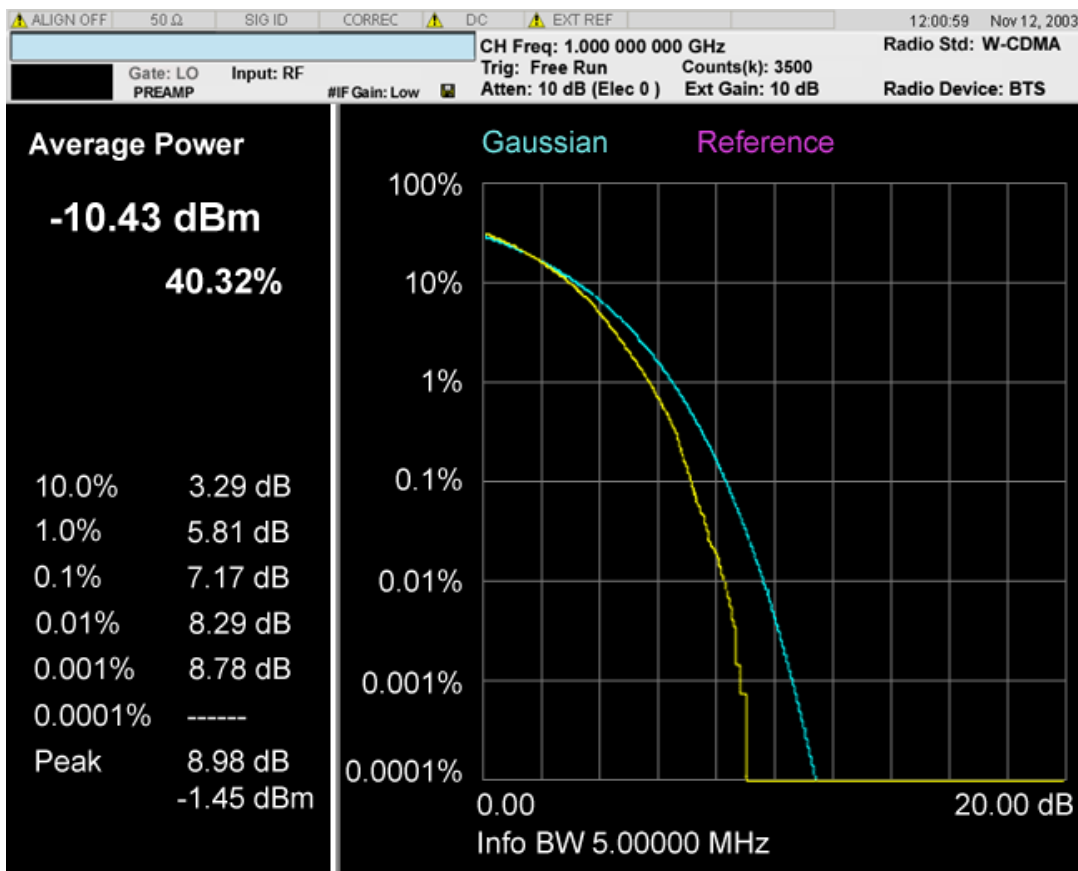

Power Stat CCDF Measurement
View/Display

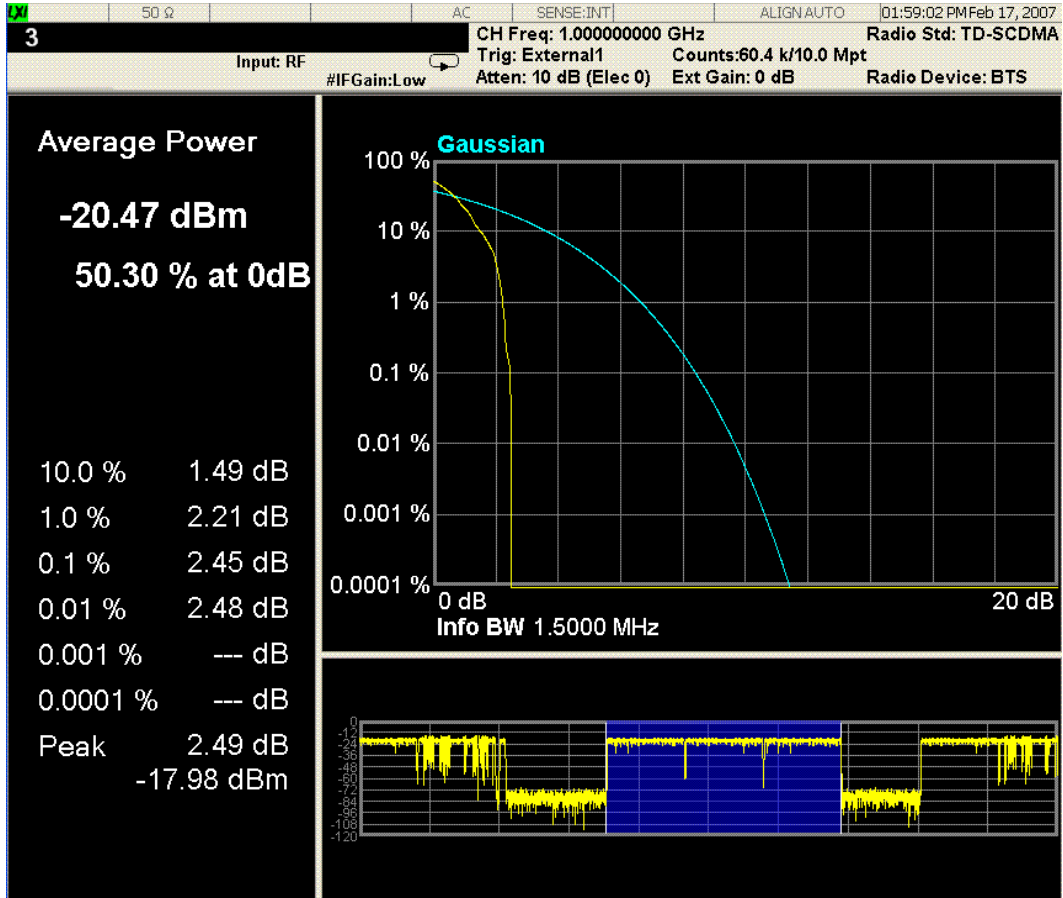

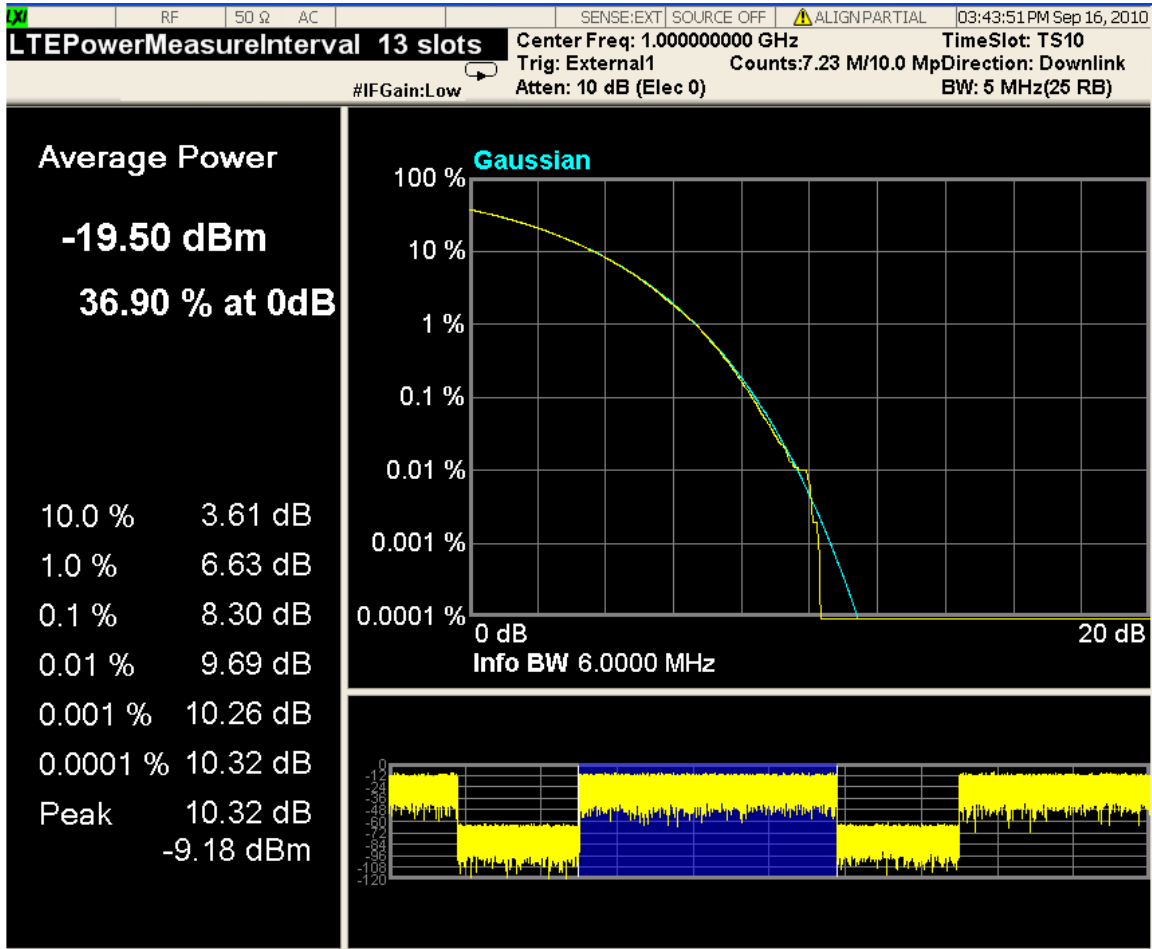

Metrics window

Name	Corresponding Results	Explanation
Average Power [dBm]	n=1 1 st Average input power	99.99 dBm
Average Power [%]	n=1 2 nd Probability at the average input power level	99.99 %
10.0% [dB]	n=1 3 rd Power level that has 10% of the power	99.99 dB
1.0% [dB]	n=1 4 th Power level that has 1% of the power	99.99 dB
0.1% [dB]	n=1 5 th Power level that has 0.1% of the power	99.99 dB
0.01% [dB]	n=1 6 th Power level that has 0.01% of the power	99.99 dB
0.001% [dB]	n=1 7 th Power level that has 0.001% of the power	99.99 dB
0.0001% [dB]	n=1 8 th Power level that has 0.0001% of the power	99.99 dB
Peak [dB]	n=1 9 th Peak power	99.99 dB
Peak[dBm]	This is not available using remote commands.	99.99 dBm

Graph window

Marker Operation	Yes
Corresponding Trace	<p>Yellow: Series of 5001 floating the current measured power stat trace. (n=2) Initially all markers refer this trace.</p> <p>Light Blue: Series of 5001 floating point numbers (in percent) that represent the Gaussian trace. (n=3)</p> <p>Violet: series of 5001 floating point numbers (in percent) that represent the user-definable reference trace. (n=4)</p> <p>The Gaussian and Reference trace/line can be removed using the features under the Trace/Detector key</p>

Wave window (TD-SCDMA and LTETDD only)

This window is only available under TD-SCDMA mode and LTETDD mode, and by default this window is closed, it could be turn of/off by soft key "SlotView", refer to section "[Slot View \(TD-SCDMA only\)](#)" on page 619.

Marker Operation	No
Corresponding Trace	Yellow: For TD-SCDMA, Wave form of entire TD-SCDMA frame. If measurement range specified by Analysis Time Slot and Measured Time Slot is out of the first frame, the display range will extend to two TD-SCDMA frames. For LTETDD, Waveform of 2 continuous LTE type2 frames. Blue: Indicate current measurement range

Key Path	Front-panel key
Initial S/W Revision	Prior to A.02.00

Display

Accesses a menu of functions that enable you to set the display parameters...

See "[Display](#)" on page 1646 for more information.

Key Path	View/Display
Initial S/W Revision	Prior to A.02.00

Slot View (TD-SCDMA only)

Switch between normal CCDF view and Slot view with additional wave window, this is available only under TD-SCDMA mode.

Key Path	View/Display
Mode	TD-SCDMA,LTETDD
Remote Command	[:SENSE]:PStatistic:SLTView[:STATE] OFF ON 0 1 [:SENSE]:PStatistic: SLTView[:STATE]?
Example	PST:SLTV OFF PST:SLTV?
Preset	OFF
State Saved	Saved in instrument state.
Range	On Off
Initial S/W Revision	Prior to A.02.00

The Spurious Emissions measurement identifies and determines the power level of spurious emissions in certain frequency bands. For measurement results and views, see [“View/Display” on page 691](#).

For information on how to make measurement using the X-Series Signal Analyzer, see:

Measurement Guide [n9080-90006.pdf].

This topic contains the following sections:

[“Measurement Commands for Spurious Emissions” on page 621](#)

[“Remote Command Results for Spurious Emissions Measurement” on page 621](#)

Measurement Commands for Spurious Emissions

The following commands can be used to retrieve the measurement results:

:CONFigure:SPURious

:CONFigure:SPURious:NDEFault

:INITiate:SPURious

:FETCh:SPURious[n]?

:READ:SPURious[n]?

:MEASure:SPURious[n]?

For more measurement related commands, see the SENSE subsystem, and the section [“Remote Measurement Functions” on page 1520](#).

Remote Command Results for Spurious Emissions Measurement

Command	Return Value
CONFigure:SPURious INITiate:SPURious	N/A
FETCh:SPURious [n]? MEASure:SPURious [n]? READ:SPURious [n]? (Note – these commands are not available when viewing the Range Table)	n = 1 (or not supplied) Returns a variable-length (1+6*Spurs – up to 1201 entries) comma separated list containing detailed information in the following format: Number of spurs in following list (Integer) [Repeat the following for each spur] Spur # Range # Spur was located (Integer) Frequency of Spur (Hz, Float64) Amplitude of Spur (dBm, Float32) Absolute Limit (dBm, Float32) Pass or Fail (1 0, Boolean)

Spurious Emissions Measurement

	<p>n = 2 – 21</p> <p>Returns a comma separated list of the trace data for the selected range (where range number = n – 1) using Detector 1. If selected range is not active SCPI_NAN is returned for each trace data element where SCPI_NAN = 9.91E37.</p>
	<p>n = 22</p> <p>Returns the number of spurs found.</p>
	<p>n = 23 – 42</p> <p>Returns a comma separated list of the trace data for the selected range (where range number = n – 22) using Detector 2. If selected range is not active or Detector 2 selection is off, SCPI_NAN is returned for each trace data element where SCPI_NAN = 9.91E37.</p>

Key Path	Meas
Initial S/W Revision	Prior to A.02.00

AMPTD Y Scale

AMPTD Y Scale opens a menu of functions that enable you to modify the Amplitude parameters.

Key Path	Front-panel key
Initial S/W Revision	Prior to A.02.00

Ref Value

Sets the value for the absolute power reference. When Auto Scaling for the Y-axis is off, the measurement uses the current reference level settings. When Auto Scaling for the Y-axis is on, the analyzer will set the reference level such that the absolute limit will be positioned two divisions down from the top of the display.

Key Path	AMPTD Y Scale
Mode	SA, WCDMA, WIMAX OFDMA, TD-SCDMA, C2k, 1xEV-DO, DVB-T/H, LTE, LTETDD, WLAN, MSR
Remote Command	:DISPlay:SPURious:VIEW[1]:WINDow[1]:TRACe:Y[:SCALE]:RLEVel < real> :DISPlay:SPURious:VIEW[1]:WINDow[1]:TRACe:Y[:SCALE]:RLEVel?
Example	DISP:SPUR:VIEW:WIND:TRAC:Y:RLEV -50 dBm DISP:SPUR:VIEW:WIND:TRAC:Y:RLEV?
Notes	You must be in the Spectrum Analysis mode, W-CDMA mode, cdma2000 mode, DVB-T/H mode, TD-SCDMA mode, LTE mode, LTETDD mode, WLAN mode, MSR or WiMAX mode to use this command. Use INSTRument:SElect to set the mode.
Couplings	When the Y Auto Scaling is off, the measurement uses the current reference level settings. When the Y Auto Scaling is on, the analyzer automatically sets the reference level such that the absolute limit is positioned two divisions down from the top of the display. This is the most useful setting when searching for spurs. The algorithm used for determining the ref level is Ref Level = Absolute Limit + (2 * Scale/Div). All other reference level settings are left as the current base instrument settings.
Preset	0.00 dBm
State Saved	Saved in instrument state.
Min	-250.0 dBm
Max	250.0 dBm
Initial S/W Revision	Prior to A.02.00
Modified at S/W Revision	A.03.00

Attenuation

This menu controls both the electrical and mechanical attenuators and their interactions. The value read back on the key in square brackets is the current Total (Elec + Mech) attenuation. When in Pre-Adjust for Min Clip mode, this value can change at the start of every measurement.

See “Attenuation” on page 1381 under AMPTD Y Scale for more information.

Key Path	AMPTD Y Scale
Initial S/W Revision	Prior to A.02.00

Scale/Div

Sets the units per division of the vertical scale in the logarithmic display. However, since the Auto Scaling is defaulted to On, this value is automatically determined by the measurement result. When you set a value manually, Auto Scaling automatically changes to Off.

Key Path	AMPTD Y Scale
Mode	SA, WCDMA, C2K, WIMAX OFDMA, TD-SCDMA, DVB-T/H, LTE, LTETDD, WLAN, MSR
Remote Command	:DISPlay:SPURious:VIEW[1]:WINDow[1]:TRACe:Y[:SCALE]:PDI Vision <rel_ampl> :DISPlay:SPURious:VIEW[1]:WINDow[1]:TRACe:Y[:SCALE]:PDI Vision?
Example	DISP:SPUR:VIEW:WIND:TRAC:Y:PDIV 10 dB DISP:SPUR:VIEW:WIND:TRAC:Y:PDIV?
Notes	You must be in the Spectrum Analysis mode, W-CDMA mode, cdma2000 mode, DVB-T/H mode, TD-SCDMA, LTE mode, LTE TDD mode, WLAN mode, MSR or WiMAX mode to use this command. Use INSTRUMENT:SElect to set the mode.
Couplings	When Auto Scaling is On, this value is automatically determined by the measurement result. When you set a value manually, Auto Scaling automatically changes to Off.
Preset	10.00 dB
State Saved	Saved in instrument state.
Range	0.10 dB to 20.00 dB
Initial S/W Revision	Prior to A.02.00
Modified at S/W Revision	A.03.00

Presel Center

See AMPTD Y Scale, “Presel Center” on page 1396 for more information.

Presel Adjust

See AMPTD Y Scale, “[Preselector Adjust](#)” on page 1398 for more information.

Y Axis Unit

Allows you to change the vertical (Y) axis amplitude unit.

See “[Y Axis Unit](#)” on page 1399 under AMPTD Y Scale for more information.

Key Path	AMPTD/Y Scale
Initial S/W Revision	A.04.00

Ref Lvl Offset

Adds an offset value to the displayed reference level. The reference level is the absolute amplitude represented by the top graticule line on the display.

See “[Reference Level Offset](#)” on page 1404 under AMPTD Y Scale for more information.

Key Path	AMPTD Y Scale
Initial S/W Revision	A.04.00

μW Path Control

The **μW Path Control** functions include the **μW Preselector Bypass** (Option MPB) and **Low Noise Path** (Option LNP) controls in the High Band path circuits.

See μ“[μW Path Control](#) ” on page 1405 under AMPTD Y Scale for more information.

Key Path	AMPTD Y Scale
Initial S/W Revision	A.04.00

Internal Preamp

Accesses a menu that enables you to control the internal preamplifiers. Turning Internal Preamp on gives a better noise figure, but a poorer inter-modulation distortion (TOI) to noise floor dynamic range. You can optimize this setting for your particular measurement.

See “[Internal Preamp](#)” on page 1410 under AMPTD Y Scale for more information.

Key Path	AMPTD Y Scale
Initial S/W Revision	Prior to A.02.00

Auto Scaling

Toggles the Auto Scaling function between On and Off.

Key Path	AMPTD Y Scale
Mode	SA, WCDMA, C2K, WIMAX OFDMA, TD-SCDMA, DVB-T/H, LTE, LTETDD, WLAN, MSR
Remote Command	:DISPlay:SPURious:VIEW[1]:WINDow[1]:TRACe:Y[:SCALe]:COU Ple 0 1 OFF ON :DISPlay:SPURious:VIEW[1]:WINDow[1]:TRACe:Y[:SCALe]:COU Ple?
Example	DISP:SPUR:VIEW:WIND:TRAC:Y:COUP OFF DISP:SPUR:VIEW:WIND:TRAC:Y:COUP?
Couplings	<p>When Auto Scaling is On and the Restart front-panel key is pressed, this function automatically determines the scale per division and reference values based on the measurement results.</p> <p>When you set a value to either Scale/Div or Ref Value manually, Auto Scaling automatically changes to Off.</p> <p>When the Y Auto Scaling is off, the measurement uses the current reference level settings. When the Y Auto Scaling is on, the analyzer automatically sets the reference level such that the absolute limit is positioned two divisions down from the top of the display. This is the most useful setting when searching for spurs. The algorithm used for determining the ref level is Ref Level = Absolute Limit + (2 * Scale/Div). All other reference level settings are left as the current base instrument settings.</p>
Preset	1
State Saved	Saved in instrument state.
Range	On Off
Backwards Compatibility SCPI	[:SENSe]:SPURious:POWer[:RF]:RANGe:AUTO
Initial S/W Revision	Prior to A.02.00
Modified at S/W Revision	A.03.00

Auto Couple

See [“Auto Couple” on page 1412](#) for more information.

Key Path	Front-panel key
Initial S/W Revision	Prior to A.02.00

BW

BW is unavailable in the Spurious Emissions measurement.

Key Path	Front-panel key
Initial S/W Revision	Prior to A.02.00

Cont

See “[Cont \(Continuous Measurement/Sweep\)](#)” on page 1413 for more information.

Key Path	Front-panel key
Initial S/W Revision	Prior to A.02.00

Frequency/Channel

The key accesses a menu allowing you to set Frequency parameters for the Gate functions.

See “[FREQ Channel](#)” on page 1414 for more information.

Key Path	Front-panel key
Initial S/W Revision	Prior to A.02.00

Input/Output

See [“Input/Output” on page 1422](#) for more information.

Key Path	Front-panel key
Initial S/W Revision	Prior to A.02.00

Marker

Displays the menu keys that enable you to select, set up and control the markers for the current measurement.

Key Path	Front-panel key
Initial S/W Revision	Prior to A.02.00

Select Marker

Displays 12 markers available for selection.

Key Path	Marker
Initial S/W Revision	Prior to A.02.00

Marker Type

Sets the marker control mode to **Normal**, **Delta** and **Off**. Normal enables you to activate the selected marker to read the power level and time. Delta enables you to read the differences in the power levels and time scales between the selected marker and the next marker. Off enables you to turn off the selected marker.

All interactions and dependencies detailed under the key description are enforced when the remote command is sent.

Key Path	Marker
Mode	SA, WCDMA, C2K, WIMAX OFDMA, TD-SCDMA, 1xEV-DO, DVB-T/H, LTE, LTETDD, WLAN, MSR
Remote Command	:CALCulate:SPURious:MARKer[1] 2 3 4 5 6 7 8 9 10 11 12: MODE POSition DELTA OFF :CALCulate:SPURious:MARKer[1] 2 3 4 5 6 7 8 9 10 11 12: MODE?
Example	CALC:SPUR:MARK:MODE POS CALC:SPUR:MARK:MODE?

Notes	<p>If the selected marker is Off, pressing Marker sets it to Normal and places it at the center of the screen on the trace determined by the Marker Trace rules. At the same time, Marker X Axis Value appears on the Active Function area.</p> <p>Default Active Function: the active function for the selected marker's current control mode. If the current control mode is Off, there is no active function and the active function is turned off.</p> <p>Active Function Display: the marker X axis value entered in the active function area will display the marker value to its full entered precision.</p> <p>You must be in the cdma2000 mode, 1xEV-DO mode, TD-SCDMA mode, W-CDMA mode, DVB-T/H mode, GSM/EDGE mode, LTE mode, LTE TDD mode, WLAN mode, MSR or WiMAX mode to use this command. Use INSTRUMENT:SElect to set the mode.</p>
Preset	=OFF
State Saved	Saved in instrument state.
Range	Normal Delta Off
Initial S/W Revision	Prior to A.02.00
Modified at S/W Revision	A.03.00

Marker X Axis Value (Remote Command only)

Sets the Marker X Axis value in the current marker X Axis Scale unit. It has no effect if the control mode is **Off**, but is the SCPI equivalent of entering an X value if the control mode is **Normal** or **Delta**.

Mode	SA, WCDMA, C2K, WIMAX OFDMA, TD-SCDMA, DVB-T/H, LTE, LTETDD, WLAN, MSR
Remote Command	<pre>:CALCulate:SPURious:MARKer[1] 2 3 4 5 6 7 8 9 10 11 12: X <freq> :CALCulate:SPURious:MARKer[1] 2 3 4 5 6 7 8 9 10 11 12: X?</pre>
Example	<pre>CALC:SPUR:MARK2:X 25 kHz CALC:SPUR:MARK3:X?</pre>
Notes	<p>If no suffix is sent it will use the fundamental units for the current marker X Axis Scale. If a suffix is sent that does not match the current marker X Axis Scale unit, an error "Invalid suffix" will be generated.</p> <p>The query returns the absolute X Axis marker value if the control mode is Normal, or the offset from the reference marker if the control mode is Delta. The query is returned in the fundamental units for the current marker X Axis scale: Hz for Frequency and Inverse Time, seconds for Period and Time. If the marker is Off, the response is not a number.</p>
Preset	1 GHz
State Saved	No

Spurious Emissions Measurement
Marker

Min	-9.9E+37
Max	9.9E+37
Initial S/W Revision	Prior to A.02.00
Modified at S/W Revision	A.03.00

Marker X Axis Position (Remote Command only)

Sets the Marker X position in trace points. It has no effect if the control mode is **Off**, but is the SCPI equivalent of entering a value if the control mode is **Normal** or **Delta** - except in trace points rather than X Axis Scale units. The entered value is immediately translated into the current X Axis Scale units for setting the value of the marker.

Mode	SA, WCDMA, C2K, WIMAX OFDMA, TD-SCDMA, 1xEV-DO, DVB-T/H, LTE, LTETDD, WLAN, MSR
Remote Command	:CALCulate:SPURious:MARKer[1] 2 3 4 5 6 7 8 9 10 11 12: X:POSition <integer> :CALCulate:SPURious:MARKer[1] 2 3 4 5 6 7 8 9 10 11 12: X:POSition?
Example	CALC:SPUR:MARK10:X:POS 300 CALC:SPUR:MARK10:X:POS?
Notes	The query returns the absolute X Axis marker value in trace points if the control mode is Normal , or the offset from the reference marker in trace points if the control mode is Delta . The value is returned as a real number, not an integer, corresponding to the translation from X Axis Scale units to trace points . If the marker is Off the response is not a number.
Preset	300
State Saved	No
Min	-9.9E+37
Max	9.9E+37
Initial S/W Revision	Prior to A.02.00
Modified at S/W Revision	A.03.00

Marker Y Axis Value (Remote Command only)

Returns the marker Y Axis value in the current marker Y Axis unit.

Mode	SA, WCDMA, C2K, WIMAX OFDMA, TD-SCDMA, 1xEV-DO, DVB-T/H, LTE, LTETDD, WLAN, MSR
Remote Command	:CALCulate:SPURious:MARKer[1] 2 3 4 5 6 7 8 9 10 11 12: Y?

Example	CALC:SPUR:MARK11:Y?
Notes	If no suffix is sent, it will use the current Y Axis unit. If a suffix is sent that does not have units of absolute amplitude, an error "Invalid suffix" will be generated.
Preset	Depends on Y axis range of selected Trace.
State Saved	No
Initial S/W Revision	Prior to A.02.00
Modified at S/W Revision	A.03.00

Properties

Accesses the Properties menu to set certain properties of the selected marker.

Key Path	Marker
Initial S/W Revision	Prior to A.02.00

Select Marker

Displays 12 markers available for selection.

Key Path	Marker
Initial S/W Revision	Prior to A.02.00

Relative To

Selects the marker the selected marker will be relative to (its reference marker).

Every marker has another marker to which it is relative. This marker is referred to as the "reference marker" for that marker. This attribute is set by the **Marker, Properties, Relative To** key. The marker must be a **Delta** marker to make this attribute relevant. If it is a **Delta** marker, the reference marker determines how the marker is controlled and how its value is displayed. A marker cannot be relative to itself.

Key Path	Marker, Properties
Mode	SA, WCDMA, C2K, WIMAX OFDMA, TD-SCDMA, 1xEV-DO, DVB-T/H, LTE, LTETDD, WLAN, MSR
Remote Command	:CALCulate:SPURious:MARKer[1] 2 3 4 5 6 7 8 9 10 11 12: REFERENCE <integer> :CALCulate:SPURious:MARKer[1] 2 3 4 5 6 7 8 9 10 11 12: REFERENCE?
Example	CALC:SPUR:MARK3:REF 5 CALC:SPUR:MARK:REF?

Spurious Emissions Measurement
Marker

Notes	<p>A marker cannot be relative to itself so that choice is grayed out, and if sent from SCPI generates error -221: “Settings conflict; marker cannot be relative to itself.”</p> <p>When queried a single value will be returned (the specified marker numbers relative marker).</p> <p>You must be in the Spectrum Analysis mode, GSM mode, LTE mode, LTE TDD mode, WLAN mode , MSR or WiMAX mode or TD-SCDMA mode to use this command. Use INSTRument:SElect to set the mode.</p>
Preset	2 3 4 5 6 7 8 9 10 11 12 1
State Saved	Saved in instrument state.
Min	1
Max	12
Initial S/W Revision	Prior to A.02.00
Modified at S/W Revision	A.03.00

Couple Markers

When this function is true, moving any marker causes an equal X Axis movement of every other marker which is not **Off**. By “equal X Axis movement” we mean that we preserve the difference between each marker’s X Axis value (in the fundamental x-axis units of the trace that marker is on) and the X Axis value of the marker being moved (in the same fundamental x-axis units).

Key Path	Marker
Mode	SA, WCDMA, C2K, WIMAX OFDMA, TD-SCDMA, 1xEV-DO, DVB-T/H, LTE, LTETDD, WLAN, MSR
Remote Command	:CALCulate:SPURious:MARKer:COUPle[:STATe] ON OFF 1 0 :CALCulate:SPURious:MARKer:COUPle[:STATe]?
Example	CALC:SPUR:MARK:COUP ON CALC:SPUR:MARK:COUP?
Preset	OFF
State Saved	Saved in instrument state.
Range	On Off
Initial S/W Revision	Prior to A.02.00
Modified at S/W Revision	A.03.00

All Markers Off

Turns off all markers.

Key Path	Marker
Mode	SA, WCDMA, C2K, WIMAX OFDMA, TD-SCDMA, 1xEV-DO, DVB-T/H, LTE, LTETDD, WLAN, MSR
Remote Command	:CALCulate:SPURious:MARKer:AOFF
Example	CALC:SPUR:MARK:AOFF
Initial S/W Revision	Prior to A.02.00
Modified at S/W Revision	A.03.00

Marker Function

There are no 'Marker Functions' supported in Spurious Emissions so this front-panel key will display a blank key menu when pressed.

Key Path	Front-panel key
Initial S/W Revision	Prior to A.02.00

Marker To

There is no 'Marker To' functionality supported in Spurious Emissions so this front-panel key will display a blank key menu when pressed.

Key Path	Front-panel key
Initial S/W Revision	Prior to A.02.00

Meas

See “[Meas](#)” on page 1520 for more information.

Key Path	Front-panel key
Initial S/W Revision	Prior to A.02.00

Meas Setup

Displays the measurement setup menu for the currently selected measurement.

Key Path	Front-panel key
Initial S/W Revision	Prior to A.02.00

Avg/Hold Num

Specifies the number of measurement averages used to calculate the measurement result. The average is displayed at the end of each sweep.

Average State allows you to turn averaging on or off.

Key Path	Meas Setup
Mode	SA, WCDMA, C2K, WIMAX OFDMA, CDMA1xEVDO, TD-SCDMA, DVB-T/H, LTE, LTETDD, WLAN, MSR
Remote Command	[:SENSe] : SPURious : AVERage : COUNT <integer> [:SENSe] : SPURious : AVERage : COUNT? [:SENSe] : SPURious : AVERage [:STATe] ON OFF 1 0 [:SENSe] : SPURious : AVERage [:STATe] ?
Example	SPUR:AVER:COUN 2500 SPUR:AVER:COUN? SPUR:AVER ON SPUR:AVER?
Notes	You must be in the Spectrum Analysis mode, W-CDMA mode, cdma2000 mode, DVB-T/H mode, TD-SCDMA mode, LTE mode, LTE TDD mode, WLAN mode, MSR or WiMAX mode to use this command. Use INSTRument:SElect to set the mode.
Preset	10 OFF
State Saved	Saved in instrument state.
Min	1
Max	10000
Initial S/W Revision	Prior to A.02.00
Modified at S/W Revision	A.03.00

Avg Mode

Enables you to set the averaging mode.

When set to Exponential (Exp) the measurement averaging continues using the specified number of averages to compute each averaged value. The average will be displayed at the end of each sweep.

When set to Repeat, the measurement resets the average counter each time the specified number of averages is reached.

Key Path	Meas Setup
Mode	SA, WCDMA, WIMAX OFDMA, TD-SCDMA, DVB-T/H, LTE, LTETDD, WLAN, MSR
Remote Command	[:SENSe]:SPURious:AVERage:TCONtrol EXPonential REPeat [:SENSe]:SPURious:AVERage:TCONtrol?
Example	SPUR:AVER:TCON REP SPUR:AVER:TCON?
Notes	You must be in the cdma2000 mode, TD-SCDMA mode, W-CDMA mode, DVB-T/H mode, GSM/EDGE mode, LTE mode, LTE TDD mode, WLAN mode, MSR or WiMAX mode to use this command. Use INSTRument:SElect to set the mode.
Preset	EXPonential
State Saved	Saved in instrument state.
Range	Exp Repeat
Initial S/W Revision	Prior to A.02.00
Modified at S/W Revision	A.03.00

Range Table

Enables you to set range parameters.

To change a parameter, select the appropriate menu softkey and enter the value using the numeric keypad or the knob. The analyzer settings will be updated with the new parameter values.

When the current view is the Range Table view, the selected range is highlighted and displayed in the Range Table automatically. With the normal window arrangement, up to five ranges are displayed. In the zoom mode, all 20 ranges can be displayed.

In the Range Table window, there are three tables corresponding to each page of the Range Table menu. When the Range Table key is pressed, the table of the first menu page is displayed.

The Displayed table is changed by changing the Range Table menu page. It can also be changed by a remote command. When the Range Table is changed by the command, the menu page changes accordingly if the Range Table menu is displayed. See [“Range Table Selection \(SCPI only command\)”](#) on

Key Path	Meas Setup
Initial S/W Revision	Prior to A.02.00

Range

Changing the range will update the values on the other menu keys so that they reflect the settings for the selected range. If Range is turned on, it will be used as part of the measurement. If it is off, it will be excluded. A range is made up of the next fifteen parameters. This parameter can send up to 20 values. The location in the list sent corresponds to the range the value is associated with. Missing values are not permitted. In other words, if you want to change values 2 and 6 you must send all values up to 6. Subsequent values will remain as they were. The query for this parameter always returns 20 values.

Key Path	Meas Setup, Range Table
Mode	SA, WCDMA, C2K, 1xEV-DO, WIMAX OFDMA, TD-SCDMA, DVB-T/H, LTE, LTETDD, MSR
Remote Command	<pre> :DISPlay:SPURious:VIEW:RANGe[:SElect] <integer> :DISPlay:SPURious:VIEW:RANGe[:SElect]? [:SENSe]:SPURious[:RANGe][:LIST]:STATe ON OFF 1 0, ON OFF 1 0, ON OFF 1 0, ON OFF 1 0, ON OFF 1 0, ON OFF 1 0, ON OFF 1 0, ON OFF 1 0, ON OFF 1 0, ON OFF 1 0, ON OFF 1 0, ON OFF 1 0, ON OFF 1 0, ON OFF 1 0, ON OFF 1 0, ON OFF 1 0, ON OFF 1 0, ON OFF 1 0, ON OFF 1 0, ON OFF 1 0 [:SENSe]:SPURious[:RANGe][:LIST]:STATe? </pre>
Example	<pre> DISP:SPUR:VIEW:RANG 2 DISP:SPUR:VIEW:RANG? SPUR:STAT ON SPUR:STAT? </pre>
Notes	You must be in cdma2000 mode, TD-SCDMA mode, W-CDMA mode, DVB-T/H mode, GSM/EDGE mode, LTE mode, LTE TDD mode, MSR or WiMAX mode to use this command. Use INSTRument:SElect to set the mode.

Spurious Emissions Measurement
Meas Setup

Res BW

Sets the resolution bandwidth of the analyzer. This parameter can send up to 20 values.

The location of where the resolution bandwidth occurs in the list sent to the measurement corresponds to the range the value is associated with.

Missing values are not permitted. In other words, if you want to change values 2 and 6 you must send all values up to 6. Subsequent values will remain as they were. The query for this parameter always returns 20 values.

Key Path	Meas Setup, Range Table
Mode	SA, WCDMA, C2K, WIMAX OFDMA, TD-SCDMA, 1xEV-DO, DVB-T/H, LTE, LTETDD, WLAN, MSR
Remote Command	<pre>[:SENSe]:SPURious[:RANGe][:LIST]:BANDwidth[:RESolution] <freq>, <freq>, <freq>, <freq>, <freq>, <freq>, <freq>, <freq>, <freq>, <freq>, <freq>, <freq>, <freq>, <freq>, <freq>, <freq>, <freq>, <freq>, <freq>, <freq> [:SENSe]:SPURious[:RANGe][:LIST]:BANDwidth[:RESolution] ? [:SENSe]:SPURious[:RANGe][:LIST]:BANDwidth[:RESolution] :AUTO OFF ON 0 1, OFF ON 0 1, OFF ON 0 1, OFF ON 0 1, OFF ON 0 1, OFF ON 0 1, OFF ON 0 1, OFF ON 0 1, OFF ON 0 1, OFF ON 0 1, OFF ON 0 1, OFF ON 0 1, OFF ON 0 1, OFF ON 0 1, OFF ON 0 1, OFF ON 0 1, OFF ON 0 1, OFF ON 0 1, OFF ON 0 1, OFF ON 0 1 [:SENSe]:SPURious[:RANGe][:LIST]:BANDwidth[:RESolution] :AUTO?</pre>
Example	<pre>SPUR:BAND 1kHz,10kHz,100kHz,1MHz,1MHz,1MHz,1MHz, 3MHz,3MHz,3MHz,3MHz,3MHz,3MHz,3MHz,3MHz,3MHz,3MHz, 3MHz,3MHz SPUR:BAND? SPUR:BWID:AUTO ON, ON, ON, OFF, OFF, OFF, OFF, OFF, ON, ON, ON, ON, OFF, OFF, OFF, OFF, OFF, OFF, ON, ON SPUR:BWID:AUTO?</pre>
Notes	You must be in cdma2000 mode, TD-SCDMA mode, W-CDMA mode, DVB-T/H, GSM/EDGE mode, LTE mode, LTE TDD mode, WLAN mode, MSR or WiMAX mode to use this command. Use INSTRUMENT:SElect to set the mode.

Spurious Emissions Measurement
Meas Setup

State Saved	Saved in instrument state.
Min	1 Hz
Max	8 MHz
Backwards Compatibility SCPI	[:SENSE]:SPURious[:RANGE][:LIST]:BANDwidth[:RESolution]
Initial S/W Revision	Prior to A.02.00
Modified at S/W Revision	A.03.00

Video BW

Sets the Video BW mode of the analyzer. This can be Auto, where the analyzer determines the optimum setting, or Manual, where you determine the setting. This parameter can send up to 20 values. The location in the list sent corresponds to the range the value is associated with. Missing values are not permitted, in other words, if you want to change values 2 and 6 you must send all values up to 6. Subsequent values will remain as they were. The query for this parameter always returns 20 values.

Key Path	Meas Setup, Range Table
Mode	SA, WCDMA, C2K, WIMAX OFDMA, TD-SCDMA, 1xEV-DO, DVB-T/H, LTE, LTETDD, WLAN, MSR
Remote Command	<pre>[:SENSE]:SPURious[:RANGE][:LIST]:BANDwidth:VIDeo <freq>, <freq>, <freq>, <freq>, <freq>, <freq>, <freq>, <freq>, <freq>, <freq>, <freq>, <freq>, <freq>, <freq>, <freq>, <freq>, <freq>, <freq>, <freq>, <freq> [:SENSE]:SPURious[:RANGE][:LIST]:BANDwidth:VIDeo? [:SENSE]:SPURious[:RANGE][:LIST]:BANDwidth:VIDeo:AUTO OFF ON 0 1, OFF ON 0 1, OFF ON 0 1, OFF ON 0 1, OFF ON 0 1, OFF ON 0 1, OFF ON 0 1, OFF ON 0 1, OFF ON 0 1, OFF ON 0 1, OFF ON 0 1, OFF ON 0 1, OFF ON 0 1, OFF ON 0 1, OFF ON 0 1, OFF ON 0 1, OFF ON 0 1, OFF ON 0 1, OFF ON 0 1, OFF ON 0 1 [:SENSE]:SPURious[:RANGE][:LIST]:BANDwidth:VIDeo:AUTO?</pre>
Example	<pre>SPUR:BAND:VID 1kHz,10kHz,100kHz,1MHz,1MHz,1MHz,1MHz, 3MHz,3MHz,3MHz,3MHz,3MHz,3MHz,3MHz,3MHz,3MHz,3MHz, 3MHz,3MHz SPUR:BAND:VID? SPUR:BAND:VID:AUTO ON, ON, OFF, OFF, OFF, ON, ON, ON, OFF, OFF, OFF, OFF, OFF, OFF, OFF, ON, ON, ON, ON, ON SPUR:BAND:VID:AUTO?</pre>
Notes	You must be in the cdma2000 mode, 1xEV-DO mode, TD-SCDMA mode, W-CDMA mode, DVB-TH mode, GSM/EDGE mode, LTE mode, LTE TDD mode, WLAN mode, MSR or WiMAX mode to use this command. Use INSTRUMENT:SElect to set the mode.

Preset	<p>SA, WCDMA, C2K, WIMAX OFDMA, TD-SCDMA, 1xEV-DO, DVB-T/H WLAN: Automatically calculated</p> <p>LTE, MSR: 4.7kHz,47kHz,470kHz,5MHz,470kHz,5MHz,5MHz,300kHz,300kHz,300kHz, 300kHz,300kHz,300kHz,300kHz,300kHz,300kHz,300kHz,300kHz,300kHz, 300kHz</p> <p>LTETDD: 4.7kHz,47kHz,470kHz,5MHz,470kHz,5MHz,5MHz,300kHz,300kHz,300kHz, 300kHz,300kHz,300kHz,300kHz,300kHz,300kHz,300kHz,300kHz,300kHz, 300kHz</p> <p>ON, ON</p> <p>DVB-T/H: OFF,OFF,OFF,OFF,OFF,OFF,OFF,ON,ON,ON,ON,ON,ON,ON,ON,ON,ON,ON, ON,ON,ON</p> <p>LTE, MSR: OFF,OFF,OFF,OFF,OFF,OFF,OFF,ON,ON,ON,ON,ON,ON,ON,ON,ON,ON,ON, ON,ON,ON</p> <p>LTETDD: OFF,OFF,OFF,OFF,OFF,OFF,OFF,ON,ON,ON,ON,ON,ON,ON,ON,ON,ON,ON, ON,ON,ON</p>
State Saved	Saved in instrument state.
Min	1 Hz
Max	50 MHz
Backwards Compatibility SCPI	[:SENSe]:SPURious[:RANGe][:LIST]:BWIDth:VIDeo
Initial S/W Revision	Prior to A.02.00
Modified at S/W Revision	A.03.00

Filter Type

Besides the Gaussian filter shape, there are certain special filter types, such as Flat Top, that are desirable under certain conditions. The **Filter Type** menu gives you control over these parameters.

Key Path	Meas Setup, Range Table
Mode	SA, WCDMA, C2K, WIMAX OFDMA, TD-SCDMA, 1xEV-DO, DVB-T/H, LTE, LTETDD, WLAN, MSR

Spurious Emissions Measurement
Meas Setup

Remote Command	[:SENSe]:SPURious[:RANGe][:LIST]:BANDwidth:SHAPE GAUSSian FLATtop, GAUSSian FLATtop, GAUSSian FLATtop, GAUSSian FLATtop, GAUSSian FLATtop, GAUSSian FLATtop, GAUSSian FLATtop, GAUSSian FLATtop, GAUSSian FLATtop, GAUSSian FLATtop, GAUSSian FLATtop, GAUSSian FLATtop, GAUSSian FLATtop, GAUSSian FLATtop, GAUSSian FLATtop, GAUSSian FLATtop, GAUSSian FLATtop, GAUSSian FLATtop, GAUSSian FLATtop, GAUSSian FLATtop [:SENSe]:SPURious[:RANGe][:LIST]:BANDwidth:SHAPE?
Example	SPUR:BAND:SHAP GAUS, GAUS, GAUS, GAUS, GAUS, GAUS, FLAT, FLAT, FLAT, FLAT, FLAT, GAUS, GAUS, GAUS, GAUS, GAUS, FLAT, FLAT, GAUS, GAUS SPUR:BAND:SHAP?
Preset	GAUS, GAUS, GAUS, GAUS, GAUS, GAUS, GAUS, GAUS, GAUS, GAUS, GAUS, GAUS, GAUS, GAUS, GAUS, GAUS, GAUS, GAUS, GAUS, GAUS
State Saved	Saved in instrument state.
Range	Gaussian (Normal) Flattop
Backwards Compatibility SCPI	[:SENSe]:SPURious[:RANGe][:LIST]:BWIDth:SHAPE
Initial S/W Revision	Prior to A.02.00
Modified at S/W Revision	A.03.00

Abs Start Limit

Determines the limit above which spurs will report a failing. If Abs Stop Limit Mode is set to Auto, this is coupled to Abs Stop Limit to make a flat limit line. If set to Man, Abs Start Limit and Abs Stop Limit can take different values to make a sloped limit line.

If the Limit Line Test parameter is off then any spurs which are found to be above the current 'Peak Excursion' will be added to the results table. From these spurs, the amplitude will be checked using the abs limit start and abs limit stop parameters and then calculate the limit. An 'F' will be appended to the amplitude value of the spur if the measured amplitude is above the limit. If the Limit Line Test is on, only the spurs whose amplitudes exceed the limit will be reported.

This parameter can send up to 20 values. The location in the list sent corresponds to the range of the associated value. Missing values are not permitted. If you want to change values 2 and 6 you must send all values up to 6. Subsequent values will remain as they were. The query for this parameter always returns 20 values.

Key Path	Meas Setup, Range Table
Mode	SA, WCDMA, C2K, WIMAX OFDMA, TD-SCDMA, 1xEV-DO, DVB-T/H, LTE, LTETDD, WLAN, MSR

Spurious Emissions Measurement
Meas Setup

State Saved	Saved in instrument state.
Min	-150.0 dBm
Max	50.0 dBm
Initial S/W Revision	Prior to A.02.00
Modified at S/W Revision	A.03.00

Abs Stop Limit

Abs Stop Limit is used to determine the limit above which spurs will report a failing. If Abs Stop Limit Mode is set to Auto, this is coupled to Abs Start Limit to make a flat limit line. If set to Man, Abs Start Limit and Abs Stop Limit can take different values to make a sloped limit line.

This parameter can send up to 20 values. The location in the list sent corresponds to the range of the associated value. Missing values are not permitted. If you want to change values 2 and 6 you must send all values up to 6. Subsequent values will remain as they were. The query for this parameter always returns 20 values.

Abs Stop Limit Mode, when set to Couple, couples Abs Start Limit and Abs Stop Limit to make a flat limit line. If set to Man, Abs Start and Abs Stop can take different values to make a sloped limit line.

This parameter can send up to 20 values. The location in the list sent corresponds to the range of the associated value. Missing values are not permitted, in other words, if you want to change values 2 and 6 you must send all values up to 6. Subsequent values will remain as they were. The query for this parameter always returns 20 values.

Key Path	Meas Setup, Range Table
Mode	SA, WCDMA, C2K, WIMAX OFDMA, TD-SCDMA, 1xEV-DO, DVB-T/H, LTE, LTETDD, WLAN, MSR
Remote Command	<pre> :CALCulate:SPURious[:RANGe][:LIST]:LIMit:ABSolute[:UPPe r]:DATA:STOP <ampl>, <ampl>, <ampl>, <ampl>, <ampl>, <ampl>, <ampl>, <ampl>, <ampl>, <ampl>, <ampl>, <ampl>, <ampl>, <ampl>, <ampl>, <ampl>, <ampl>, <ampl>, <ampl>, <ampl> :CALCulate:SPURious[:RANGe][:LIST]:LIMit:ABSolute[:UPPe r]:DATA:STOP? :CALCulate:SPURious[:RANGe][:LIST]:LIMit:ABSolute[:UPPe r]:DATA:STOP:AUTO OFF ON 0 1, OFF ON 0 1, OFF ON 0 1, OFF ON 0 1, OFF ON 0 1, OFF ON 0 1, OFF ON 0 1, OFF ON 0 1, OFF ON 0 1, OFF ON 0 1, OFF ON 0 1, OFF ON 0 1, OFF ON 0 1, OFF ON 0 1, OFF ON 0 1, OFF ON 0 1, OFF ON 0 1, OFF ON 0 1, OFF ON 0 1, OFF ON 0 1 :CALCulate:SPURious[:RANGe][:LIST]:LIMit:ABSolute[:UPPe r]:DATA:STOP:AUTO? </pre>

<p>Example</p>	<pre> CALC:SPUR:LIM:ABS:DATA:STOP -25,-25 CALC:SPUR:LIM:ABS:DATA:STOP? CALC:SPUR:LIM:ABS:DATA:STOP:AUTO ON, ON, ON, ON, ON, ON, ON, ON, ON, ON, ON, ON, ON, ON, ON, ON, ON, ON, ON, ON CALC:SPUR:LIM:ABS:DATA:STOP:AUTO? </pre>
<p>Preset</p>	<pre> SA, WIMAX OFDMA: -5.00000000E+001,-5.00000000E+001,-5.00000000E+001,-5.00000000E+ 001,-5.00000000E+001,-5.00000000E+001,-5.00000000E+001,-5.000000 00E+001,-5.00000000E+001,-5.00000000E+001,-5.00000000E+001,-5.0000 0000E+001,-5.00000000E+001,-5.00000000E+001,-5.00000000E+001,-5.0 0000000E+001,-5.00000000E+001,-5.00000000E+001,-5.00000000E+001, -5.00000000E+001 WCDMA: -36dBm,-36dBm,-36dBm,-30dBm,-25dBm,-15dBm,-25dBm,-30dBm,-50 dBm,-50dBm,-50dBm,-50dBm,-50dBm,-50dBm,-50dBm,-50dBm,-50dB m,-50dBm,-50dBm,-50dBm C2K, 1xEV-DO: -13 dBm, -13dBm, -13 dBm, -13 dBm, -50 dBm, -50 dBm, -50 dBm, -50 dBm, -50 dBm, -50 dBm, -50 dBm, -50 dBm, -50 dBm, -50 dBm, -50 dBm, -50 dBm, -50 dBm, -50 dBm, -50 dBm, -50 dBm TD-SCDMA: -13 dBm, -13dBm, -13 dBm, -13 dBm, -50 dBm, -50 dBm, -50 dBm, -50 dBm, -50 dBm, -50 dBm, -50 dBm, -50 dBm, -50 dBm, -50 dBm, -50 dBm, -50 dBm, -50 dBm, -50 dBm, -50 dBm, -50 dBm DVB-T/H: -36dBm, -82dBm, -36dBm, -76dBm, -36dBm, -30dBm, -50dBm, -50dBm, -50dBm, -50dBm, -50dBm, -50dBm, -50dBm, -50dBm, -50dBm, -50dBm, -50dBm, -50dBm, -50dBm, -50dBm LTE, MSR: -36dBm,-36dBm,-36dBm,-30dBm,-96dBm,-30dBm,-30dBm,-50dBm,-50 dBm,-50dBm,-50dBm,-50dBm,-50dBm,-50dBm,-50dBm,-50dBm,-50dB m,-50dBm,-50dBm,-50dBm LTETDD: -36dBm,-36dBm,-36dBm,-52dBm,-52dBm,-30dBm,-30dBm,-50dBm,-50 dBm,-50dBm,-50dBm,-50dBm,-50dBm,-50dBm,-50dBm,-50dBm,-50dB m,-50dBm,-50dBm,-50dBm WLAN: -36dBm,-36dBm,-36dBm,-30dBm,-50dBm,-50dBm,-50dBm,-50dBm,-50 dBm,-50dBm,-50dBm,-50dBm,-50dBm,-50dBm,-50dBm,-50dBm,-50dB m,-50dBm,-50dBm,-50dBm ON,ON ON,ON </pre>

Spurious Emissions Measurement
Meas Setup

State Saved	Saved in instrument state.
Min	-150.0 dBm
Max	50.0 dBm
Initial S/W Revision	Prior to A.02.00
Modified at S/W Revision	A.03.00

Peak Excursion

Sets the minimum amplitude variation of signals that can be identified as peaks. If a value of 6 dB is selected, peaks that rise and fall more than 6 dB above the peak threshold value are identified. This parameter can send up to 20 values. The location in the list sent corresponds to the range of the associated value. Missing values are not permitted. If you want to change values 2 and 6 you must send all values up to 6. Subsequent values will remain as they were. The query for this parameter always returns 20 values.

Key Path	Meas Setup, Range Table
Mode	SA, WCDMA, C2K, WIMAX OFDMA, TD-SCDMA, 1xEV-DO, DVB-T/H, LTE, LTETDD, WLAN, MSR
Remote Command	[:SENSE]:SPURious[:RANGE][:LIST]:PEAK:EXCURSION <rel_ampl>, <rel_ampl>, <rel_ampl>, <rel_ampl>, <rel_ampl>, <rel_ampl>, <rel_ampl>, <rel_ampl>, <rel_ampl>, <rel_ampl>, <rel_ampl>, <rel_ampl>, <rel_ampl>, <rel_ampl>, <rel_ampl>, <rel_ampl>, <rel_ampl>, <rel_ampl>, <rel_ampl>, <rel_ampl> [:SENSE]:SPURious[:RANGE][:LIST]:PEAK:EXCURSION?
Example	SPUR:PEAK:EXC 20,20, 20, 20, 20, 20, 20, 20, 20, 20, 20, 20, 20, 20, 20, 20, 20, 20, 20, 20, 20 SPUR:PEAK:EXC?
Preset	+6.00000000E+000,+6.00000000E+000,+6.00000000E+000,+6.00000000E+000,+6.00000000E+000,+6.00000000E+000,+6.00000000E+000,+6.00000000E+000,+6.00000000E+000,+6.00000000E+000,+6.00000000E+000,+6.00000000E+000,+6.00000000E+000,+6.00000000E+000,+6.00000000E+000,+6.00000000E+000,+6.00000000E+000,+6.00000000E+000,+6.00000000E+000,+6.00000000E+000
State Saved	Saved in instrument state.
Min	0.0 dB
Max	100.0 dB
Initial S/W Revision	Prior to A.02.00
Modified at S/W Revision	A.03.00

Pk Threshold

Sets the minimum amplitude of signals that can be identified as peaks. For example, if a value of -90 dBm is selected, only peaks that rise and fall more than the peak excursion value which are above -90 dBm are identified. This parameter can send up to 20 values. The location in the list sent corresponds to the range of the associated value. Missing values are not permitted. If you want to change values 2 and 6 you must send all values up to 6. Subsequent values will remain as they were. The query for this parameter always returns 20 values.

Key Path	Meas Setup, Range Table
Mode	SA, WCDMA, C2K, WIMAX OFDMA, TD-SCDMA, 1xEV-DO, DVB-T/H, LTE, LTETDD, WLAN, MSR
Remote Command	[:SENSe] :SPURious [:RANGe] [:LIST] :PEAK :THReshold <real>, <real>, <real>, <real>, <real>, <real>, <real>, <real>, <real>, <real>, <real>, <real>, <real>, <real>, <real>, <real>, <real>, <real>, <real>, <real> [:SENSe] :SPURious [:RANGe] [:LIST] :PEAK :THReshold?
Example	SPUR:PEAK:THR 0,0,0 SPUR:PEAK:THR?
Preset	-9.00000000E+001,-9.00000000E+001,-9.00000000E+001,-9.00000000E+001,-9.00000000E+001,-9.00000000E+001,-9.00000000E+001,-9.00000000E+001,-9.00000000E+001,-9.00000000E+001,-9.00000000E+001,-9.00000000E+001,-9.00000000E+001,-9.00000000E+001,-9.00000000E+001,-9.00000000E+001,-9.00000000E+001,-9.00000000E+001,-9.00000000E+001,-9.00000000E+001
State Saved	Saved in instrument state.
Min	-200
Max	0
Initial S/W Revision	Prior to A.02.00
Modified at S/W Revision	A.03.00, A.07.00

Attenuation

Defines attenuation value for each range. When Auto state is ON, attenuation value under AMPTD Y Scale is used. When Auto state is OFF, this value is used as mechanical attenuation value without electric attenuation.

Key Path	Meas Setup, Range Table
Mode	SA, WCDMA, C2K, WIMAX OFDMA, TD-SCDMA, 1xEV-DO, DVB-T/H, LTE, LTETDD, WLAN, MSR

Mode	SA, WCDMA, C2K, WIMAX OFDMA, TD-SCDMA, 1xEV-DO, DVB-T/H, LTE, LTETDD, WLAN, MSR
Remote Command	<pre>[:SENSe]:SPURious[:RANGe][:LIST]:SWEep:TIME <time>, <time>, <time>, <time>, <time>, <time>, <time>, <time>, <time>, <time>, <time>, <time>, <time>, <time>, <time>, <time>, <time>, <time>, <time>, <time> [:SENSe]:SPURious[:RANGe][:LIST]:SWEep:TIME? [:SENSe]:SPURious[:RANGe][:LIST]:SWEep:TIME:AUTO OFF ON 0 1,OFF ON 0 1,OFF ON 0 1,OFF ON 0 1,OFF ON 0 1,OFF ON 0 1, OFF ON 0 1,OFF ON 0 1,OFF ON 0 1,OFF ON 0 1,OFF ON 0 1,OFF ON 0 1, OFF ON 0 1,OFF ON 0 1,OFF ON 0 1,OFF ON 0 1,OFF ON 0 1,OFF ON 0 1, OFF ON 0 1,OFF ON 0 1,OFF ON 0 1,OFF ON 0 1,OFF ON 0 1,OFF ON 0 1 [:SENSe]:SPURious[:RANGe][:LIST]:SWEep:TIME:AUTO?</pre>
Example	<pre>SPUR:SWE:TIME 10,10,10,10,10,10,10,10,10,10,10,10,10,10,10,10,10,10,10,10 SPUR:SWE:TIME? SPUR:SWE:TIME:AUTO ON,ON SPUR:SWE:TIME:AUTO?</pre>
Notes	You must be in cdma2000 mode, TD-SCDMA mode, W-CDMA mode, DVB-T/H, SA mode, LTE mode, LTE TDD mode, WLAN mode, MSR or WiMAX mode to use this command. Use INSTRument:SElect to set the mode.
Preset	Automatically calculated
State Saved	Saved in instrument state.
Min	1.0E-3
Max	2.0E+3
Initial S/W Revision	Prior to A.02.00
Modified at S/W Revision	A.03.00

Points

Sets the number of points per sweep for the measurement. This parameter can send up to 20 values. The location in the list sent corresponds to the range of the associated value. Missing values are not permitted. If you want to change values 2 and 6 you must send all values up to 6. Subsequent values will remain as they were. The query for this parameter always returns 20 values.

The Points mode can be manual, where you determine the setting or auto, where the analyzer determines the number of trace points to ensure the sweep points resolution equals RBW/2. This is calculated using the following algorithm:

$$\text{Points} = (\text{Stop Freq} - \text{Start Freq}) / (\text{ResBW} / 2), \text{ with the computed values being clipped to a minimum of 601 and a maximum of 20001.}$$

State Saved	Saved in instrument state.
Min	601
Max	20001
Initial S/W Revision	Prior to A.02.00
Modified at S/W Revision	A.03.00

IF Gain

Sets the IF Gain function to Auto, On (the extra 10 dB) or Off. These settings affect sensitivity and IF overloads. A switched IF amplifier with approximately 10 dB of gain is available. This amplifier takes full advantage of the RF dynamic range of the analyzer. When it can be turned on without an overload, the dynamic range is always better with the amplifier on than off.

Key Path	Meas Setup
Initial S/W Revision	Prior to A.02.00

IF Gain Auto

Activates the rules for auto IF Gain.

Mode	SA, WCDMA, C2K, WIMAX OFDMA, TD-SCDMA, 1xEV-DO, DVB-T/H, LTE, LTETDD, WLAN, MSR
Remote Command	[:SENSe] : SPURious : IF : GAIN : AUTO [: STATE] OFF ON 0 1 , OFF ON 0 1 [:SENSe] : SPURious : IF : GAIN : AUTO [: STATE] ?
Example	SPUR : IF : GAIN : AUTO ON , ON SPUR : IF : GAIN : AUTO ?
Couplings	When the sweep type is Swept, 'Auto' sets IF Gain to High Gain under any of the following conditions: the input attenuator is set to 0 dB, the preamp is turned on, or the Max Mixer Level is 20 dBm or lower. For other settings using the swept sweep type, auto sets IF Gain to Low Gain.
Preset	OFF, OFF, OFF, OFF, OFF, OFF, OFF, OFF, OFF, OFF, OFF, OFF, OFF, OFF, OFF, OFF, OFF, OFF, OFF, OFF
State Saved	Saved in instrument state.
Range	Auto Man
Initial S/W Revision	Prior to A.02.00
Modified at S/W Revision	A.03.00

Spurious Emissions Measurement
Meas Setup

IF Gain State

Selects the range of IF Gain.

Mode	SA, WCDMA, C2K, WIMAX OFDMA, TD-SCDMA, 1xEV-DO, DVB-T/H, LTE, LTETDD, WLAN, MSR
Remote Command	[:SENSe]:SPURious:IF:GAIN[:STATe] OFF ON 0 1, OFF ON 0 1, OFF ON 0 1, OFF ON 0 1, OFF ON 0 1, OFF ON 0 1, OFF ON 0 1, OFF ON 0 1, OFF ON 0 1, OFF ON 0 1, OFF ON 0 1, OFF ON 0 1, OFF ON 0 1, OFF ON 0 1, OFF ON 0 1, OFF ON 0 1, OFF ON 0 1, OFF ON 0 1, OFF ON 0 1, OFF ON 0 1 [:SENSe]:SPURious:IF:GAIN[:STATe]?
Example	SPUR:IF:GAIN ON,ON SPUR:IF:GAIN?
Preset	OFF,OFF,OFF,OFF,OFF,OFF,OFF,OFF,OFF,OFF,OFF,OFF,OFF,OFF,OFF,OFF,OFF,OFF,OFF,OFF
State Saved	Saved in instrument state.
Range	Low Gain (Best for Large Signals) High Gain (Best Noise Level)
Initial S/W Revision	Prior to A.02.00

Meas Type

Selects either Examine or Full measurement type. This parameter is coupled to the average mode. Therefore, if the examine measurement type is selected, the measurement sets the average mode to exponential. If the full measurement type is selected, the measurement sets the average mode to repeat. The behavior of each measurement type is described in the table below. When averaging is on, trace averaging is used as each active range is measured. Averaging is not used at any other time.

	Single		Continuous	
	No Spurs Found	Spurs Found	No Spurs Found	Spurs Found
Examine	All active ranges are measured. On completion the measurement is set to the idle state and the 'No Spurs' happening is displayed.	All active ranges are measured and the spurs found reported. On completion the measurement is set to the idle state and the trace containing the worst spur restored. The spur menu key is enabled. A marker is also added which is set to the frequency of the worst spur.	All active ranges are measured. On completion the SA remains set to last range checked with an active trace and the 'No Spurs' happening is displayed.	All active ranges are measured and the spurs found reported. On completion the SA is set to the range containing the worst spur found and continually sweeps this range. The spur menu key is enabled. A marker is also added which is set to the frequency of the worst spur.

	Single		Continuous	
Full	All active ranges are measured. On completion measurement is set to idle state and the 'No Spurs' happening is displayed.	All active ranges are measured and spurs found reported. On completion the measurement is set to the idle state, displaying the trace of the last active range.	Measurement continually cycles through all active ranges.	All active ranges are measured and spurs found reported. On each cycle of the active ranges the spurs found are reset. This ensures any remote queries retrieve the trace data that matches the currently displayed results.

Key Path	Meas Setup
Mode	SA, WCDMA, C2K, WIMAX OFDMA, TD-SCDMA, 1xEV-DO, DVB-T/H, LTE, LTETDD, WLAN, MSR
Remote Command	[:SENSE] : SPURious : TYPE EXAMine FULL [:SENSE] : SPURious : TYPE ?
Example	SPUR:TYPE FULL SPUR:TYPE ?
Preset	EXAMine
State Saved	Saved in instrument state.
Range	Examine Full
Initial S/W Revision	Prior to A.02.00
Modified at S/W Revision	A.03.00

Spur

Displays any spurs found. It is only enabled when the measurement type is set to examine and will turn on upon completion of a measurement. Once the Spur menu key has been enabled, you can view any spur. The measurement sets the analyzer to the range in which the currently selected spur was found. The range settings only changes if the spur selected is in a range which is different from the current range settings. A marker is used to identify the currently selected spur on the trace.

Key Path	Meas Setup
Mode	SA, WCDMA, C2K, WIMAX OFDMA, CDMA1xEVDO, TD-SCDMA, DVB-T/H, LTE, LTETDD, WLAN, MSR
Remote Command	[:SENSE] : SPURious : SPUR <integer> [:SENSE] : SPURious : SPUR ?
Example	SPUR:SPUR 55 SPUR:SPUR ?
Preset	1

Spurious Emissions Measurement
Meas Setup

State Saved	No
Min	1
Max	200
Initial S/W Revision	Prior to A.02.00
Modified at S/W Revision	A.03.00

Spurious Report Mode

Sets the spurious report mode to either Limit Line Test Only or All.

Select the Limit Line Test (LIMTest) option to report only spurs above the limit line. Any spurs reported will cause the measurement to fail. See Abs Start Limit for more information.

Select All (ALL) to report all spurs detected by Peak Threshold and Peak Excursion.

Key Path	Meas Setup
Mode	SA, WCDMA, C2K, WIMAX OFDMA, TD-SCDMA, 1xEV-DO, DVB-T/H, LTE, LTETDD, WLAN, MSR
Remote Command	[:SENSE] : SPURious : REPT : MODE ALL LIMTest [:SENSE] : SPURious : REPT : MODE ?
Example	SPUR:REPT:MODE LIMIT SPUR:REPT:MODE ?
Preset	ALL
State Saved	Saved in instrument state.
Range	All Limit Test
Initial S/W Revision	Prior to A.02.00
Modified at S/W Revision	A.03.00

Fast Spurious Meas (Remote Command only)

This command is provided as the backward compatibility SCPI command of the Fast Spurious Measurement. Since this command is another representation of Spurious Report Mode, this command is coupled with the command.

When set to ON, only spurs above the limit line will be reported. This is the same as Spurious Report Mode “LIMTest” When set to OFF, all detected spurs will be reported. This is the same as Spurious Report Mode “ALL.”

Mode	SA, WCDMA, C2K, WIMAX OFDMA, TD-SCDMA, 1xEV-DO, DVB-T/H, WLAN, MSR
------	--

Remote Command	[:SENSE] :SPURious:FSMeas ON OFF 1 0 [:SENSE] :SPURious:FSMeas?
Example	SPUR:FSM ON SPUR:FSM?
Couplings	If SPUR:REPT:MODE is ALL, this parameter is OFF. If SPUR:REPT:MODE is LIMTest, this parameter is ON.
Preset	OFF
State Saved	Saved in instrument state.
Initial S/W Revision	A.04.00

Meas Preset

Restores all measurement parameters to their default values.

Key Path	Meas Setup
Mode	SA, WCDMA, C2K, WIMAX OFDMA, TD-SCDMA, 1xEV-DO, DVB-T/H, LTE, LTETDD, WLAN, MSR
Remote Command	:CONFigure:SPURious
Example	CONF:SPUR
Initial S/W Revision	Prior to A.02.00
Modified at S/W Revision	A.03.00

Range Preset (TD-SCDMA only)

Sets the specific range parameters to meet the requirement of the BS mandatory limits (Category A), the BS mandatory limits (Category B) and the MS mandatory and optional limits in the TD-SCDMA mode. This key only shows up in the TD-SCDMA mode.

Key Path	Meas Setup
Initial S/W Revision	Prior to A.02.00

Category A (TD-SCDMA only)

Sets the range parameters to meet the requirement of the BS mandatory spurious emissions limits (Category A).

BS Mandatory spurious emissions limits, Category A

Band	Maximum level	Measurement bandwidth	Note

Spurious Emissions Measurement
Meas Setup

9 kHz – 150 kHz	-13 dBm	1 kHz	Bandwidth as in ITU-R SM.329-9, s4.1
150 kHz – 30 MHz		10 kHz	Bandwidth as in ITU-R SM.329-9, s4.1
30 MHz – 1 GHz		100 kHz	Bandwidth as in ITU-R SM.329-9, s4.1
1 GHz – 12,75 GHz		1 MHz	Upper frequency as in ITU-R SM.329-9, s2.5 table 1

(The requirement applies at frequencies within the specified frequency ranges which are more than 4 MHz under the first carrier frequency used or more than 4 MHz above the last carrier frequency used.)

Key Path	Meas Setup, Range Preset
Mode	TD-SCDMA
Remote Command	[:SENSe]:SPURious:CATegory:A
Example	SPUR:CAT:A
Dependencies	This key is grayed out when the radio device is MS.
Initial S/W Revision	Prior to A.02.00

Category B (TD-SCDMA only)

Sets the range parameters to meet the requirement of the BS mandatory spurious emissions limits (Category B).

BS Mandatory spurious emissions limits, Category B

Band	Maximum Level	Measurement Bandwidth	Note
9kHz – 150kHz	-36 dBm	1 kHz	Bandwidth as in ITU SM.329-9, s4.1
150kHz – 30MHz	- 36 dBm	10 kHz	Bandwidth as in ITU SM.329-9, s4.1
30MHz – 1GHz	-36 dBm	100 kHz	Bandwidth as in ITU SM.329-9, s4.1
1GHz / Fc1-19,2 MHz or Fl -10 MHz whichever is the higher	-30 dBm	1 MHz	Bandwidth as in ITU SM.329-9, s4.1
Fc1 – 19,2 MHz or Fl -10 MHz whichever is the higher / Fc1 – 16 MHz or Fl -10 MHz whichever is the higher	-25 dBm	1 MHz	Specification in accordance with ITU-R SM.329-9, s4.1

Band	Maximum Level	Measurement Bandwidth	Note
Fc1 – 16 MHz or Fl –10 MHz whichever is the higher / Fc2 + 16 MHz or Fu +10 MHz whichever is the lower	–15 dBm	1 MHz	Specification in accordance with ITU-R SM.329–9, s4.1
Fc2 + 16 MHz or Fu + 10 MHz whichever is the lower / Fc2 +19,2 MHz or Fu + 10 MHz whichever is the lower	–25 dBm	1 MHz	Specification in accordance with ITU-R SM.329–9, s4.1
Fc2 + 19,2 MHz or Fu +10 MHz whichever is the lower / 12,75 GHz	–30 dBm	1 MHz	Bandwidth as in ITU-R SM.329–9, s4.1. Upper frequency as in ITU-R SM.329–9, s2.5 table 1

(The requirement applies at frequencies within the specified frequency ranges which are more than 4 MHz under the first carrier frequency used or more than 4 MHz above the last carrier frequency used.)

Key Path	Meas Setup, Range Preset
Mode	TD-SCDMA
Remote Command	[:SENSe] : SPURious : CATegory : B
Example	SPUR:CAT:B
Dependencies	This key is grayed out when the radio device is MS.
Initial S/W Revision	Prior to A.02.00

Mobile (TD-SCDMA only)

Sets the range parameters to meet the requirement of both the MS general and additional spurious emissions limits.

General Spurious emissions requirements

Frequency Bandwidth	Resolution Bandwidth	Minimum requirement
9 kHz ≤ f < 150 kHz	1 kHz	–36 dBm

Spurious Emissions Measurement Meas Setup

$150 \text{ kHz} \leq f < 30 \text{ MHz}$	10 kHz	-36 dBm
$30 \text{ MHz} \leq f < 1000 \text{ MHz}$	100 kHz	-36 dBm
$1 \text{ GHz} \leq f < 12.75 \text{ GHz}$	1 MHz	-30 dBm

Additional Spurious emissions requirements

Frequency Bandwidth	Resolution Bandwidth	Minimum requirement
$925 \text{ MHz} \leq f \leq 935 \text{ MHz}$	100 KHz	-67 dBm*
$935 \text{ MHz} < f \leq 960 \text{ MHz}$	100 KHz	-79 dBm*
$1805 \text{ MHz} \leq f \leq 1880 \text{ MHz}$	100 KHz	-71 dBm*

* The measurements are made on frequencies which are integer multiples of 200 kHz.

(These requirements are only applicable for frequencies which are greater than 4 MHz away from the UE center carrier frequency.)

Key Path	Meas Setup, Range Preset
Mode	TD-SCDMA
Remote Command	[:SENSE]:SPURious:CATegory:MS
Example	SPUR:CAT:MS
Notes	The former command “[:SENSE]:SPURious:CATegory:MOBile” is still supported.
Dependencies	This key is grayed out when the radio device is BTS.
Initial S/W Revision	Prior to A.02.00

Frequency Setup (TD-SCDMA only)

Sets the required frequency parameters for the calculation of the start/stop frequency of the spurious emissions limits in TD-SCDMA mode.

The measurement does not restart when changing the values of the setup parameters. These parameters are used for calculating the range start and stop frequency in the measurement only. If you are going to perform a measurement with the newly-input values,, one of the soft key in the “Range Preset” menu should also be pressed afterwards.

Key Path	Meas Setup
Initial S/W Revision	Prior to A.02.00

Center Frequency of the First Carrier (Fc1) (TD-SCDMA only)

Sets the center frequency of emission of the first carrier transmitted by the base station. This parameter is used for calculating the start/stop frequency of the range for base station when the softkey “Category A”

or “Category B” under the range preset menu pressed.

Key Path	Meas Setup, Freq Setup
Mode	TD-SCDMA
Remote Command	[:SENSE] : SPURious : CARRier : FREQuency : STARt <freq> [:SENSE] : SPURious : CARRier : FREQuency : STARt?
Example	SPUR:CARR:FREQ:STAR 2GHz SPUR:CARR:FREQ:STAR?
Notes	You must be in the TD-SCDMA mode. Use INSTRument:SELEct to set the mode.
Couplings	Coupled with Fc2 and Fl. The value of Fc1 is always not greater than the value of Fc2, and greater than the value of Fl. The following inequation for Fl, Fc1, Fc2 and Fu is satisfied: $Fl + 0.8MHz \leq Fc1 \leq Fc2 \leq Fu - 0.8 MHz$; This key is grayed-out when the radio device is MS.
Preset	2.0156 GHz
State Saved	Saved in instrument state.
Min	See Coupling
Max	See Coupling
Initial S/W Revision	Prior to A.02.00

Center Frequency of the Last Carrier (Fc2) (TD-SCDMA only)

Sets the center frequency of emission of the last carrier transmitted by the base station. This parameter is used for calculating the start/stop frequency of the range for base station when the softkey “Category A” or “Category B” under the range preset menu pressed.

Key Path	Meas Setup, Freq Setup
Mode	TD-SCDMA
Remote Command	[:SENSE] : SPURious : CARRier : FREQuency : STOP <freq> [:SENSE] : SPURious : CARRier : FREQuency : STOP?
Example	SPUR:CARR:FREQ:STOP 10GHz SPUR:CARR:FREQ:STOP?
Notes	You must be in the TD-SCDMA mode. Use INSTRument:SELEct to set the mode.
Dependencies	This key is grayed out when the radio device is MS.
Couplings	Coupled with Fc1 and Fu. The value of Fc2 is always not less than the value of Fc1, and less than the value of Fu. The following inequation for Fl, Fc1, Fc2 and Fu is satisfied: $Fl + 0.8MHz \leq Fc1 \leq Fc2 \leq Fu - 0.8 MHz$;

Spurious Emissions Measurement
Meas Setup

Preset	2.0236 GHz
State Saved	Saved in instrument state.
Min	See Coupling
Max	See Coupling
Initial S/W Revision	Prior to A.02.00

TDD Lower Frequency (Fl) (TD-SCDMA only)

Sets the lower frequency of the band in which TDD operates. This parameter is used for calculating the start/stop frequency of the range for base station when the softkey “Category B” under the range preset menu pressed.

Key Path	Meas Setup, Freq Setup
Mode	TD-SCDMA
Remote Command	[:SENSE] : SPURious : TDD : FREQuency : STARt <freq> [:SENSE] : SPURious : TDD : FREQuency : STARt ?
Example	SPUR:TDD:FREQ:STAR 1GHz SPUR:TDD:FREQ:STAR ?
Notes	You must be in the TD-SCDMA mode. Use INSTRument:SElect to set the mode.
Dependencies	This key is grayed out when the radio device is MS.
Couplings	Coupled with Fc1. The value of Fl is always less than the value of Fc1. The following inequation for Fl, Fc1, Fc2 and Fu is satisfied: $F_l + 0.8\text{MHz} \leq F_{c1} \leq F_{c2} \leq F_u - 0.8\text{MHz}$;
Preset	2.010 GHz
State Saved	Saved in instrument state.
Min	1.011 GHz
Max	See Coupling
Initial S/W Revision	Prior to A.02.00

TDD Upper Frequency (Fu) (TD-SCDMA only)

Sets the upper frequency of the band in which TDD operates. This parameter is used for calculating the start/stop frequency of the range for base station when the softkey “Category B” under the range preset menu pressed.

Key Path	Meas Setup, Freq Setup
Mode	TD-SCDMA

Remote Command	[:SENSE] : SPURious : TDD : FREQuency : STOP <freq> [:SENSE] : SPURious : TDD : FREQuency : STOP?
Example	SPUR:TDD:FREQ:STOP 1GHz SPUR:TDD:FREQ:STOP?
Notes	You must be in the TD-SCDMA mode. Use INSTRument:SELEct to set the mode.
Dependencies	This key is grayed out when the radio device is MS.
Couplings	Coupled with Fc2. The value of Fu is always greater than the value of Fc2. The following inequation for Fl, Fc1, Fc2 and Fu is satisfied: Fl + 0.8MHz <= Fc1 <= Fc2 <= Fu - 0.8 MHz;
Preset	2.025 GHz
State Saved	Saved in instrument state.
Min	See Coupling
Max	3.689 GHz
Initial S/W Revision	Prior to A.02.00

Center Frequency for Mobile (TD-SCDMA only)

Sets the center frequency of the mobile. This parameter is used for calculating the start/stop frequency of the range for mobile after the softkey “Mobile” under the range preset menu pressed.

Key Path	Meas Setup, Freq Setup
Mode	TD-SCDMA
Remote Command	[:SENSE] : SPURious : CARRier : FREQuency : MS <freq> [:SENSE] : SPURious : CARRier : FREQuency : MS?
Example	SPUR:CARR:FREQ:MS 2GHz SPUR:CARR:FREQ:MS?
Notes	You must be in the TD-SCDMA mode. Use INSTRument:SELEct to set the mode. The former SCPI commands “[:SENSE]:SPURious:CARRier:FREQuency:MOBil <freq>” and “[:SENSE]:SPURious:CARRier:FREQuency:MOBil?” are still supported.
Dependencies	This key is grayed out when the radio device is BTS.
Preset	2.0204 GHz
State Saved	Saved in instrument state.
Min	1.005 GHz
Max	3.695 GHz

Spurious Emissions Measurement
Meas Setup

Initial S/W Revision	Prior to A.02.00
----------------------	------------------

CH Mean Power (DVB-T/H only)

Set the mean power of the signal channel. The enter value is used to calculate the limit parameter which is different according as the different mean power of the transmitter. This key only shows up in the DVB-T/H.

Category A (mean power < 25W)

Freq Range	Limit	RBW	Note
9kHz~174MHz	-36dBm	100kHz	Required by EN302-296 Chapter 4.2.1 for DVB-T transmitter.
174MHz~400MHz	-82dBm	4kHz	
400MHz~790MHz	-36dBm	100kHz	
790MHz~862MHz	-76dBm	4kHz	
862MHz~1GHz	-36dBm	100kHz	
> 1GHz	-30dBm	100kHz	

Category B (25W<mean power<=1000W)

Freq Range	Limit	RBW	Note
9kHz~174MHz	-36dBm	100kHz	Required by EN302-296 Chapter 4.2.1 for DVB-T transmitter.
174MHz~400MHz	-126dBc	4kHz	
400MHz~790MHz	-36dBm	100kHz	
790MHz~862MHz	-120dBc	4kHz	
862MHz~1GHz	-36dBm	100kHz	
> 1GHz	-30dBm	100kHz	

Category C (mean power > 1000W)

Freq Range	Limit	RBW	Note
9kHz~174MHz	-36dBm	100kHz	Required by EN302-296 Chapter 4.2.1 for DVB-T transmitter.
174MHz~400MHz	-66dBm	4kHz	
400MHz~790MHz	-36dBm	100kHz	
790MHz~862MHz	-60dBm	4kHz	
862MHz~1GHz	-36dBm	100kHz	
> 1GHz	-30dBm	100kHz	

Key Path	Meas Setup
Mode	DVB-T/H
Remote Command	[:SENSe]:SPURious:CARRier:POWer <real> [:SENSe]:SPURious:CARRier:POWer?
Example	SPUR:CARR:POW -30.00 dBm SPUR:CARR:POW?
Couplings	When the mean power of the signal channel is between 25 watt and 1000 watt, the measurement uses the current enter value as the reference to calculate the limit parameters.
Preset	-30.00 dBm
State Saved	Saved in instrument state.
Min	-250.0 dBm
Max	250.0 dBm
Initial S/W Revision	A.02.00

Mode

See “[Mode](#)” on page 1534 for more information.

Key Path	Front-panel key
Initial S/W Revision	Prior to A.02.00

Mode Setup

See [“Mode Setup” on page 1553](#) for more information.

Key Path	Front-panel key
Initial S/W Revision	Prior to A.02.00

Peak Search

Places the selected marker on the trace point with the maximum y-axis value for that marker's trace.

Key Path	Front-panel key
Mode	SA, WCDMA, C2K, WIMAX OFDMA, 1xEV-DO, DVB-T/H, LTE, LTETDD, WLAN, MSR
Remote Command	:CALCulate:SPURious:MARKer[1] 2 3 4 5 6 7 8 9 10 11 12:MAXimum
Example	CALC:SPUR:MARK2:MAX
Initial S/W Revision	Prior to A.02.00
Modified at S/W Revision	A.03.00

Next Peak

Moves the selected marker to the peak that has the next highest amplitude less than the current marker value.

Key Path	Peak Search
Mode	SA, WCDMA, C2K, WIMAX OFDMA, TD-SCDMA, 1xEV-DO, DVB-T/H, LTE, LTETDD, WLAN, MSR
Remote Command	:CALCulate:SPURious:MARKer[1] 2 3 4 5 6 7 8 9 10 11 12:MAXimum:NEXT
Example	CALC:SPUR:MARK2:MAX:NEXT
Initial S/W Revision	Prior to A.02.00
Modified at S/W Revision	A.03.00

Next Pk Right

Moves the selected marker to the nearest peak to the right of the current marker which meets all enabled peak criteria.

Key Path	Peak Search
Mode	SA, WCDMA, C2K, WIMAX OFDMA, TD-SCDMA, 1xEV-DO, DVB-T/H, LTE, LTETDD, WLAN
Remote Command	:CALCulate:SPURious:MARKer[1] 2 3 4 5 6 7 8 9 10 11 12:MAXimum:RIGHT
Example	CALC:SPUR:MARK2:MAX:RIGH
Initial S/W Revision	Prior to A.02.00

Modified at S/W Revision	A.03.00
--------------------------	---------

Next Pk Left

Moves the selected marker to the nearest peak to the left of the current marker which meets all enabled peak criteria.

Key Path	Peak Search
Mode	SA, WCDMA, C2K, WIMAX OFDMA, TD-SCDMA, 1xEV-DO, DVB-T/H, LTE, LTETDD, WLAN, MSR
Remote Command	:CALCulate:SPURious:MARKer[1] 2 3 4 5 6 7 8 9 10 11 12:MAXimum:LEFT
Example	CALC:SPUR:MARK2:MAX:LEFT
Initial S/W Revision	Prior to A.02.00
Modified at S/W Revision	A.03.00

Marker Delta

Performs the same function as the Delta 1-of-N selection key in the Marker menu. This sets the control mode for the selected marker to Delta mode. See the Marker section for the complete description of this function. The key is duplicated here in the Peak Search Menu to allow you to conveniently perform a peak search and change the control of the Marker mode to Delta without having to access two separate menus.

Key Path	Peak Search
Initial S/W Revision	Prior to A.02.00

Pk-Pk Search

Finds and displays the amplitude and frequency (or time, if in zero span) differences between the highest and lowest y-axis value.

Key Path	Peak Search
Mode	SA, WCDMA, C2K, WIMAX OFDMA, TD-SCDMA, 1xEV-DO, DVB-T/H, LTE, LTETDD, WLAN, MSR
Remote Command	:CALCulate:SPURious:MARKer[1] 2 3 4 5 6 7 8 9 10 11 12:PTPeak
Example	CALC:SPUR:MARK:PTP
Notes	Turns on the Marker Δ
Dependencies	This key is not available (key is grayed-out) when Coupled Markers is on.
Initial S/W Revision	Prior to A.02.00

Spurious Emissions Measurement
Peak Search

Modified at S/W Revision	A.03.00
--------------------------	---------

Min Search

Moves the selected marker to the minimum y-axis value on the current trace.

Key Path	Peak Search
Mode	SA, WCDMA, C2K, WIMAX OFDMA, TD-SCDMA, 1xEV-DO, DVB-T/H, LTE, LTETDD, WLAN, MSR
Remote Command	:CALCulate:SPURious:MARKer[1] 2 3 4 5 6 7 8 9 10 11 12:MINimum
Example	CALC:SPUR:MARK:MIN
Initial S/W Revision	Prior to A.02.00
Modified at S/W Revision	A.03.00

Recall

See “[Recall](#)” on page 194 for more information.

Key Path	Front-panel key
Initial S/W Revision	Prior to A.02.00

Restart

See “Restart” on page 1558 for more information.

Key Path	Front-panel key
Initial S/W Revision	Prior to A.02.00

Save

See [“Save” on page 207](#) for more information.

Key Path	Front-panel key
Initial S/W Revision	Prior to A.02.00

Single

See “[Single \(Single Measurement/Sweep\)](#)” on page 1563 for more information.

Key Path	Front-panel key
Initial S/W Revision	Prior to A.02.00

Source

See “Source” on page 1564 for more information.

Key Path	Front-panel key
Initial S/W Revision	Prior to A.02.00

Span X Scale

Span X Scale is unavailable in the Spurious Emissions measurement.

Key Path	Front-panel key
Initial S/W Revision	Prior to A.02.00

Sweep/Control

Accesses the Sweep/Control menu keys used to set up and control the sweep time and source.

Key Path	Front-panel key
Initial S/W Revision	Prior to A.02.00

Sweep Setup

Sets the sweep functions that control the sweep state and time.

Key Path	Sweep/Control
Initial S/W Revision	Prior to A.02.00

Auto Sweep Time Rules

Switches the analyzer between normal and accuracy sweep states. Setting **Auto Sweep Time** to **Accy** will result in slower sweep times, usually about three times as long, but better amplitude accuracy for CW signals. The instrument amplitude accuracy specifications only apply when **Auto Sweep Time** is set to **Accy**.

Additional amplitude errors which occur when **Auto Sweep Time** is set to **Norm** are usually well under 0.1 dB, though this is not guaranteed. Because of the faster sweep times and still low errors, **Norm** is the preferred setting of **Auto Sweep Time**. **Auto Sweep Time** is set to **Norm** on a **Preset** or **Auto Couple**. This means that in the Preset or Auto Coupled state, instrument amplitude accuracy specifications do not apply.

Key Path	Sweep/Control, Sweep Setup
Mode	SA, WCDMA, C2K, WIMAX OFDMA, TD-SCDMA, 1xEV-DO, DVB-T/H, LTE, LTETDD, WLAN, MSR
Remote Command	[:SENSE] :SPURious:SWEep:TIME:AUTO:RULEs NORMal ACCuracy [:SENSE] :SPURious:SWEep:TIME:AUTO:RULEs?
Example	SPUR:SWE:TIME:AUTO:RUL ACC SPUR:SWE:TIME:AUTO:RUL?
Notes	In Zero Span, this key is irrelevant and inaccessible (because the whole Sweep Setup menu is grayed out), however, Sweep Setup settings can be changed remotely with no error indication.
Preset	NORMal
State Saved	Saved in instrument state.
Range	Norm Accy
Initial S/W Revision	Prior to A.02.00

Spurious Emissions Measurement Sweep/Control

Modified at S/W Revision	A.03.00
--------------------------	---------

Pause

Pauses a measurement after the current data acquisition is complete.

When Paused, the label on the key changes to Resume. Pressing the Resume resumes the measurement at the point it was at when paused.

See [“Pause/Resume” on page 1577](#) for more information.

Key Path	Sweep/Control
Initial S/W Revision	Prior to A.02.00

Gate

Accesses a menu that enables you to control the gating function .See Measurement Functions for more details.

The Gate functionality is used to view signals best viewed by qualifying them with other events. See [“Gate ” on page 1578](#) for more details.

Key Path	Sweep/Control
Initial S/W Revision	A.03.00

Trace/Detector

Trace/Detector is unavailable in the Spurious Emissions measurement.

Key Path	Front-panel key
Initial S/W Revision	Prior to A.02.00

Trigger

Accesses the Trigger menu which contains keys to control the 1-of-N selection of the Trigger source.

The trigger functions let you select the trigger settings for a sweep or measurement.

See [“Trigger” on page 1595](#) for more information.

Key Path	Front-panel key
Initial S/W Revision	Prior to A.02.00

View/Display

Accesses a menu that includes keys that enables you to control the instrument display.

Key Path	Front-panel key
Initial S/W Revision	Prior to A.02.00

Display

Accesses a menu of functions that enable you to set the display parameters.

See “[Display](#)” on page 1646 for more information.

Key Path	View/Display
Initial S/W Revision	Prior to A.02.00

View Selection

Selects the desired view, Result Metrics or Range Table.

- Graph + Metrics – The lower window displays a list of spurs detected in a measurement cycle. The upper window displays a trace of the range that contains the currently selected spur.
- Range Table – The lower window displays settings of ranges. The upper window displays a trace of the currently selected range.

Key Path	View/Display
Mode	SA, WCDMA, C2K, 1xEV-DO, WIMAX OFDMA, TD-SCDMA, DVB-T/H, LTE, LTETDD, MSR
Remote Command	:DISPlay:SPURious:VIEW[:SElect] RESult RANGE :DISPlay:SPURious:VIEW[:SElect]?
Example	DISP:SPUR:VIEW RANG DISP:SPUR:VIEW?
Notes	You must be in cdma2000 mode, TD-SCDMA mode, W-CDMA mode, DVB-T/H mode, GSM/EDGE mode, LTE mode, LTE TDD mode, MSR or WiMAX mode to use this command. Use INSTRument:SElect to set the mode.
Preset	RESult
State Saved	No
Range	Graph + Metrics Range Table
Initial S/W Revision	A.10.00

Graph + Metrics

Graph + Metrics is used to view measurement results.

The lower window displays a list of spurs detected in a measurement cycle. The currently selected spur, which is highlighted, can be changed by the Spur softkey in the Meas Setup menu.

The upper window displays a trace of the range that contains the currently selected spur.

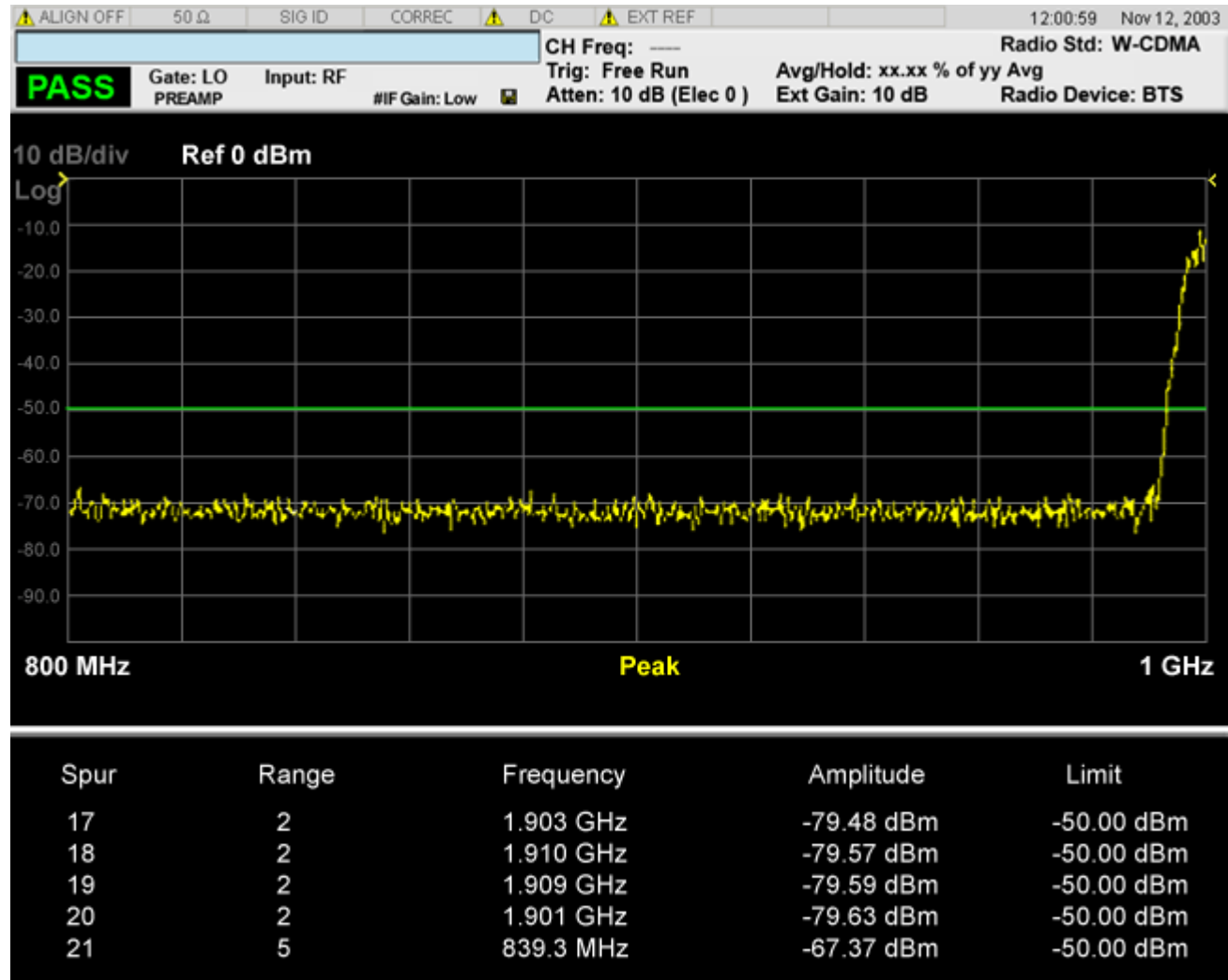

Result	Units	Min	Max
Spur	N/A	0	200
Range	N/A	1	20
Frequency	Hz	Analyzer Min	Analyzer Max
Amplitude	dBm	-150	50
Limit	dBm	-150	50
Initial S/W Revision	Prior to A.02.00		

The spurs listed are within the current value of the Marker Peak Excursion setting of the absolute limit. All of the spurs listed passed. Any spur that has failed the absolute limit will have an 'F' beside it.

Range Table

Range table is used to view range settings.

The upper window displays a trace of the range specified by the Range key under Range Table in Meas Setup. The lower window displays the range setting. All enabled range might not be displayed with the normal window arrangement. Even in that case, the instrument always displays the highlighted line in the table. When you zoom the lower window, all 20 ranges can be displayed.

When the range state is OFF, "---" will appear to indicate the range is inactive.

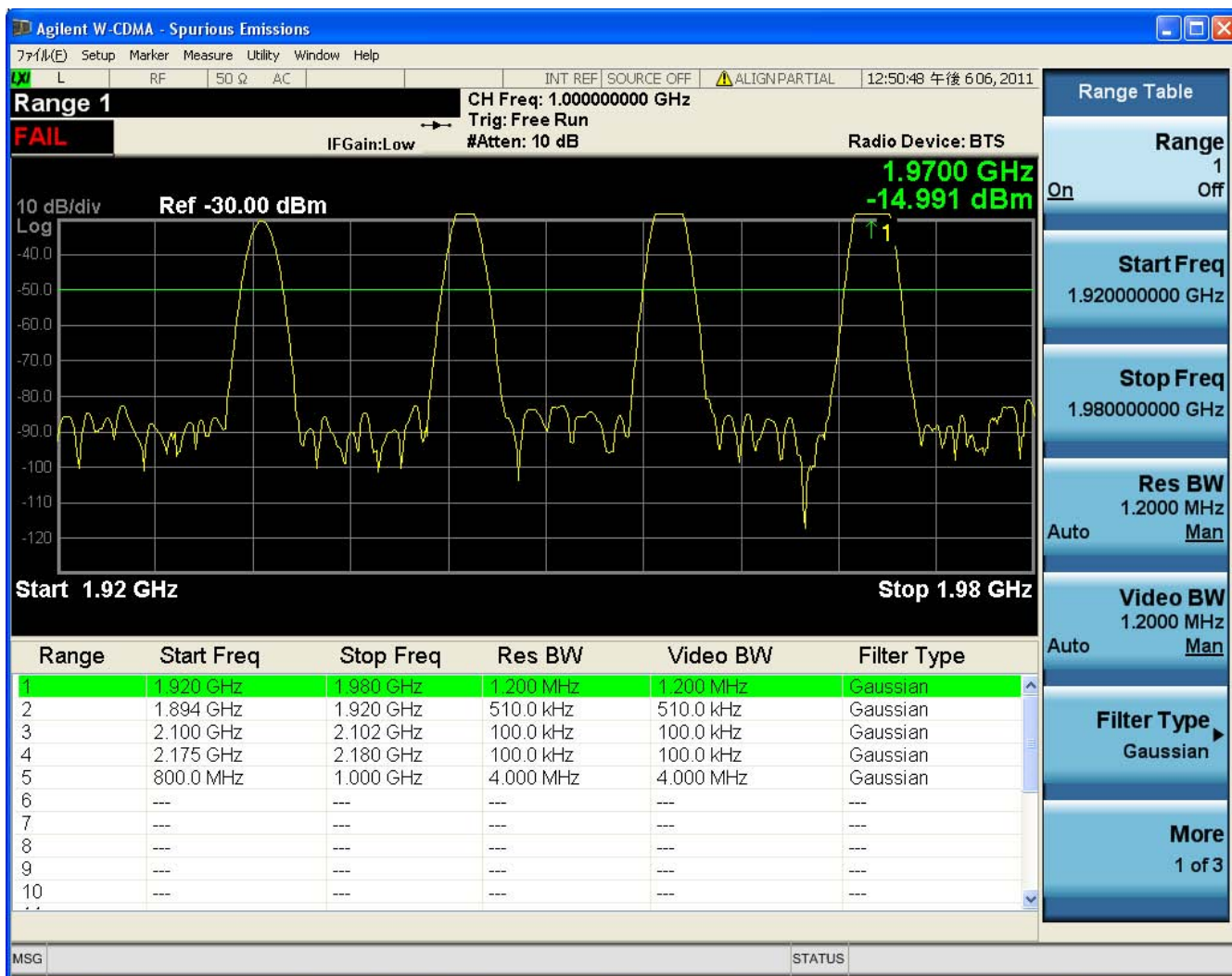

Spurious Emissions Measurement
View/Display

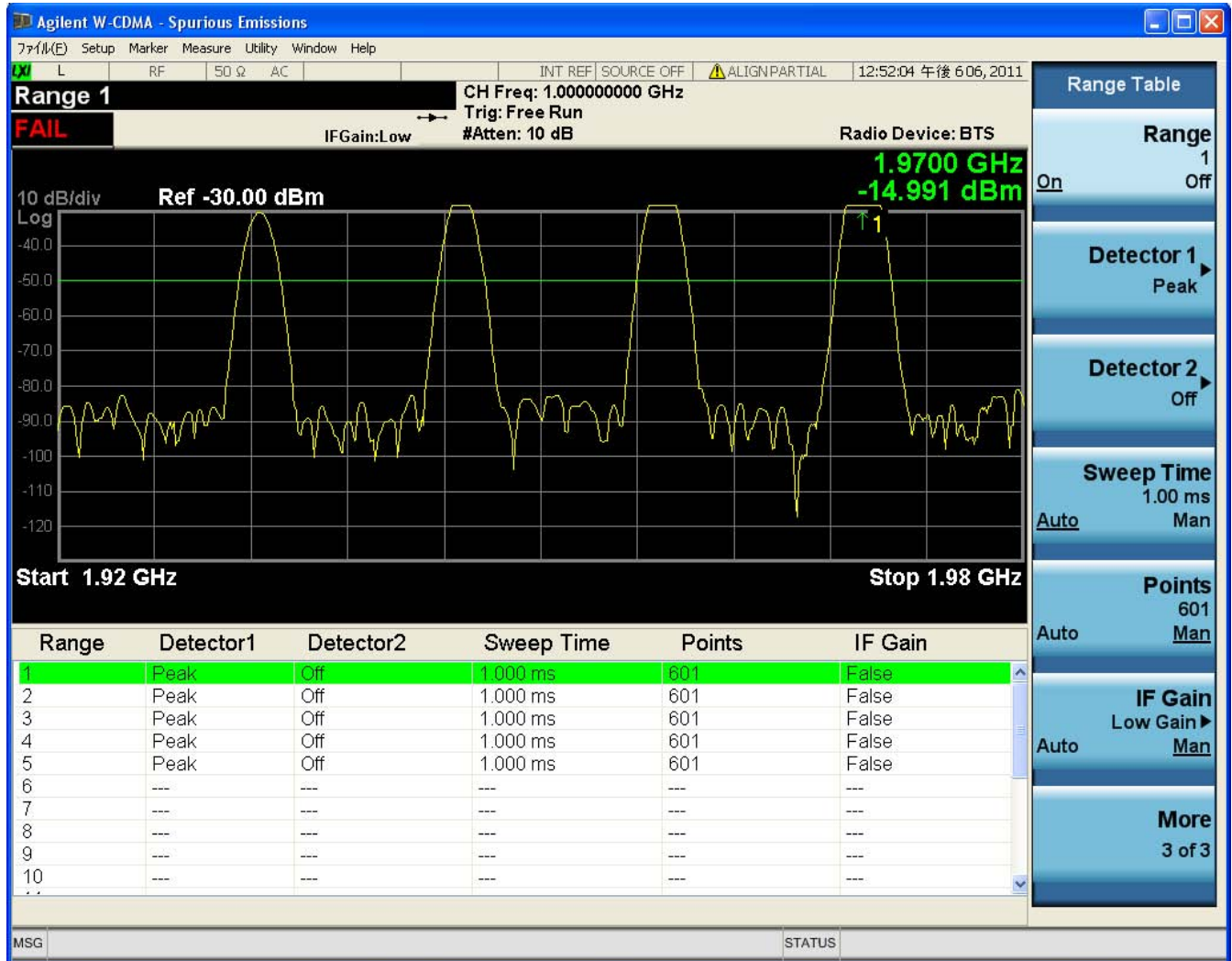

Range Table Selection (SCPI only command)

Switches contents of Range Table. There are three tables in the Range Table window, corresponding to each page of the Range Table menu.

If the Range Table menu is displayed, this command changes the page of the Range Table menu too.

Pressing the Range Table softkey always changes the current Range Table to 1.

Key Path	SCPI only
Mode	SA, WCDMA, C2K, 1xEV-DO, WIMAX OFDMA, TD-SCDMA, DVB-T/H, LTE, LTETDD, MSR
Remote Command	:DISPlay:SPURious:VIEW:RANGe:TABLE <integer> :DISPlay:SPURious:VIEW:RANGe:TABLE?

Example	DISP:SPUR:VIEW:RANG:TABL 2 DISP:SPUR:VIEW:RANG:TABL?
Notes	You must be in cdma2000 mode, TD-SCDMA mode, W-CDMA mode, DVB-T/H mode, GSM/EDGE mode, LTE mode, LTE TDD mode, MSR or WiMAX mode to use this command. Use INSTRument:SElect to set the mode.
Preset	1
State Saved	No
Min	1
Max	3
Initial S/W Revision	A.10.00

The spectrum emission mask measures spurious signal levels in up to six pairs of offset frequencies and relates them to the carrier power. For measurement results and views, see [“View/Display” on page 815](#).

For information on how to make measurement using the X-Series Signal Analyzer, see:

Measurement Guide [n9080-90006.pdf].

This topic contains the following sections:

[“Measurement Commands for Spectrum Emission Mask” on page 697](#)

[“Remote Command Results for Spectrum Emission Mask Measurement” on page 698](#)

Measurement Commands for Spectrum Emission Mask

Offsets that are turned off (inactive) will return -999.0 when their results are queried over SCPI.

```
:CONFigure:SEMask
```

```
:CONFigure:SEMask:NDEFault
```

```
:INITiate:SEMask
```

```
:FETCh:SEMask[n]?
```

```
:MEASure:SEMask[n]?
```

```
:READ:SEMask[n]?
```

For more measurement related commands, see the SENSE subsystem, and the section [“Remote Measurement Functions” on page 1520](#).

Remote Command Results for Spectrum Emission Mask Measurement

Command		Return Value
FETCh:SEMask[n]? MEASure:SEMask[n]? READ:SEMask[n]?	N=1	In case the Meas Type is: Total Power Reference Returns 82 comma-separated scalar results, in the following order: <ol style="list-style-type: none"> 1. Reserved for the future use, returns -999.0 2. Absolute power at the center frequency (reference) area (dBm) 3. Reserved for the future use, returns -999.0 4. Reserved for the future use, returns -999.0 5. Peak frequency in the center frequency (reference) area (Hz) 6. Reserved for the future use, returns -999.0 7. Reserved for the future use, returns -999.0 8. Reserved for the future use, returns -999.0 9. Reserved for the future use, returns -999.0 10. Reserved for the future use, returns -999.0 11. Relative integrated power on the negative offset A (dBc) 12. Absolute integrated power on the negative offset A (dBm) 13. Relative peak power on the negative offset A (dBc) 14. Absolute peak power on the negative offset A (dBm) 15. Peak power offset frequency from the center or carrier edge frequency in the negative offset A, depending on Offset Frequency Define settings (Hz) 16. Relative integrated power on the positive offset A (dBc) 17. Absolute integrated power on the positive offset A (dBm) 18. Relative peak power on the positive offset A (dBc) 19. Absolute peak power on the positive offset A (dBm) 20. Peak power offset frequency from the center or carrier edge frequency in the positive offset A, depending on Offset Frequency Define settings (Hz) 21. Relative integrated power on the negative offset B (dBc) ... 69. Absolute peak power on the positive offset F (dBm) 70. Peak power offset frequency from the center or carrier edge frequency in the positive offset F, depending on Offset Frequency Define settings (Hz)

Command		Return Value
	N=1	71. Minimum margin from limit line on the negative offset A (dB) 72. Minimum margin from limit line on the positive offset A (dB) 73. Minimum margin from limit line on the negative offset B (dB) 74. Minimum margin from limit line on the positive offset B (dB) 75. Minimum margin from limit line on the negative offset C (dB) 76. Minimum margin from limit line on the positive offset C (dB) 77. Minimum margin from limit line on the negative offset D (dB) 78. Minimum margin from limit line on the positive offset D (dB) 79. Minimum margin from limit line on the negative offset E (dB) 80. Minimum margin from limit line on the positive offset E (dB) 81. Minimum margin from limit line on the negative offset F (dB) 82. Minimum margin from limit line on the positive offset F (dB)

Command		Return Value
	N=1	<p>In case the Meas Type is: Power Spectral Density Reference</p> <p>Returns 82 comma-separated scalar results, in the following order:</p> <ol style="list-style-type: none"> 1. Reserved for the future use, returns -999.0 2. Absolute power at the center frequency (reference) area (dBm/Hz) 3. Reserved for the future use, returns -999.0 4. Reserved for the future use, returns -999.0 5. Peak frequency in the center frequency (reference) area (Hz) 6. Reserved for the future use, returns -999.0 7. Reserved for the future use, returns -999.0 8. Reserved for the future use, returns -999.0 9. Reserved for the future use, returns -999.0 10. Reserved for the future use, returns -999.0 11. Relative integrated power on the negative offset A (dB). 12. Absolute integrated power on the negative offset A (dBm/Hz). 13. Relative peak power on the negative offset A (dB) 14. Absolute peak power on the negative offset A (dBm/Hz) 15. Peak power offset frequency from the center or carrier edge frequency in the negative offset A, depending on Offset Frequency Define settings (Hz) 16. Relative integrated power on the positive offset A (dB). 17. Absolute integrated power on the positive offset A (dBm/Hz). 18. Relative peak power on the positive offset A (dB) 19. Absolute peak power on the positive offset A (dBm/Hz) 20. Peak power offset frequency from the center or carrier edge frequency in the positive offset A, depending on Offset Frequency Define settings (Hz) 21. Relative integrated power on the negative offset B (dB). ... 69. Absolute peak power on the positive offset F (dBm/Hz) 70. Peak power offset frequency from the center or carrier edge frequency in the positive offset F, depending on Offset Frequency Define settings (Hz)

Command		Return Value
	N=1	71. Minimum margin from limit line on the negative offset A (dB) 72. Minimum margin from limit line on the positive offset A (dB) 73. Minimum margin from limit line on the negative offset B (dB) 74. Minimum margin from limit line on the positive offset B (dB) 75. Minimum margin from limit line on the negative offset C (dB) 76. Minimum margin from limit line on the positive offset C (dB) 77. Minimum margin from limit line on the negative offset D (dB) 78. Minimum margin from limit line on the positive offset D (dB) 79. Minimum margin from limit line on the negative offset E (dB) 80. Minimum margin from limit line on the positive offset E (dB) 81. Minimum margin from limit line on the negative offset F (dB) 82. Minimum margin from limit line on the positive offset F (dB)

Command		Return Value
	N=1	<p>In case the Meas Type is: Spectrum Peak Reference</p> <p>Returns 82 comma-separated scalar results, in the following order:</p> <ol style="list-style-type: none"> 1. Reserved for the future use, returns -999.0 2. Peak power at the center frequency (reference) area (dBm) 3. Reserved for the future use, returns -999.0 4. Reserved for the future use, returns -999.0 5. Peak frequency in the center frequency (reference) area (Hz) 6. Reserved for the future use, returns -999.0 7. Reserved for the future use, returns -999.0 8. Reserved for the future use, returns -999.0 9. Reserved for the future use, returns -999.0 10. Reserved for the future use, returns -999.0 11. Reserved for the future use, returns -999.0 12. Reserved for the future use, returns -999.0 13. Relative peak power on the negative offset A (dB) 14. Absolute peak power on the negative offset A (dBm) 15. Peak power offset frequency from the center or carrier edge frequency in the negative offset A, depending on Offset Frequency Define settings (Hz) 16. Reserved for the future use, returns -999.0 17. Reserved for the future use, returns -999.0 18. Relative peak power on the positive offset A (dB) 19. Absolute peak power on the positive offset A (dBm) 20. Peak power offset frequency from the center or carrier edge frequency in the positive offset A, depending on Offset Frequency Define settings (Hz) 21. Reserved for the future use, returns -999.0 ... 69. Absolute peak power on the positive offset F (dBm) 70. Peak power offset frequency from the center or carrier edge frequency in the positive offset F, depending on Offset Frequency Define settings (Hz)

Command		Return Value
	N=1	71. Minimum margin from limit line on the negative offset A (dB) 72. Minimum margin from limit line on the positive offset A (dB) 73. Minimum margin from limit line on the negative offset B (dB) 74. Minimum margin from limit line on the positive offset B (dB) 75. Minimum margin from limit line on the negative offset C (dB) 76. Minimum margin from limit line on the positive offset C (dB) 77. Minimum margin from limit line on the negative offset D (dB) 78. Minimum margin from limit line on the positive offset D (dB) 79. Minimum margin from limit line on the negative offset E (dB) 80. Minimum margin from limit line on the positive offset E (dB) 81. Minimum margin from limit line on the negative offset F (dB) 82. Minimum margin from limit line on the positive offset F (dB)

Command		Return Value
In MSR mode	N=1	<p>In case the Meas Type is: Total Power Reference</p> <p>Returns 82 comma-separated scalar results, in the following order:</p> <ol style="list-style-type: none"> 1. Total Absolute power of carriers of Measure Carrier On if available. Otherwise –999.0 is returned. 2. Absolute power at the reference carrier. Absolute power at the left reference carrier if Ref Chan type is Left & Right Carriers. (dBm) 3. Absolute power at the right reference carrier if Ref Chan type is Left & Right Carriers. (dBm). Otherwise –999.0 is returned. 4. Reserved for the future use, returns –999.0 5. Peak frequency in the ref carrier channel spacing frequency range . Peak frequency in the left ref carrier channel spacing frequency range if Ref Chan type is Left & Right Carriers. 6. Peak frequency in the right ref carrier channel spacing frequency range if Ref Chan type is Left & Right Carriers. Otherwise –999.0 is returned. 7. Reserved for the future use, returns –999.0 8. Reserved for the future use, returns –999.0 9. Reserved for the future use, returns –999.0 10. Reserved for the future use, returns –999.0 11. Relative integrated power on the negative offset A (dBc) 12. Absolute integrated power on the negative offset A (dBm) 13. Relative peak power on the negative offset A (dBc) 14. Absolute peak power on the negative offset A (dBm) 15. Peak power offset frequency from the center or carrier edge frequency in the negative offset A, depending on Offset Frequency Define settings (Hz) 16. Relative integrated power on the positive offset A (dBc) 17. Absolute integrated power on the positive offset A (dBm) 18. Relative peak power on the positive offset A (dBc) 19. Absolute peak power on the positive offset A (dBm) 20. Peak power offset frequency from the center or carrier edge frequency in the positive offset A, depending on Offset Frequency Define settings (Hz) 21. Relative integrated power on the negative offset B (dBc) ... 69. Absolute peak power on the positive offset F (dBm) 70. Peak power offset frequency from the center or carrier edge frequency in the positive offset F, depending on Offset Frequency Define settings (Hz)

Command		Return Value
	N=1	71. Minimum margin from limit line on the negative offset A (dB) 72. Minimum margin from limit line on the positive offset A (dB) 73. Minimum margin from limit line on the negative offset B (dB) 74. Minimum margin from limit line on the positive offset B (dB) 75. Minimum margin from limit line on the negative offset C (dB) 76. Minimum margin from limit line on the positive offset C (dB) 77. Minimum margin from limit line on the negative offset D (dB) 78. Minimum margin from limit line on the positive offset D (dB) 79. Minimum margin from limit line on the negative offset E (dB) 80. Minimum margin from limit line on the positive offset E (dB) 81. Minimum margin from limit line on the negative offset F (dB) 82. Minimum margin from limit line on the positive offset F (dB)

Command		Return Value
In MSR mode	N=1	<p>In case the Meas Type is: Power Spectral Density Reference</p> <p>Returns 82 comma-separated scalar results, in the following order:</p> <ol style="list-style-type: none"> 1. Total Absolute power of carriers of Measure Carrier On if available.. Otherwise –999.0 is returned. 2. Absolute power at the reference carrier. Absolute power at the left reference carrier if Ref Chan type is Left & Right Carriers. (dBm/Hz) 3. Absolute power at the right reference carrier if Ref Chan type is Left & Right Carriers. (dBm/Hz). Otherwise –999.0 is returned. 4. Reserved for the future use, returns –999.0 5. Peak frequency in the ref carrier channel spacing frequency range . Peak frequency in the left ref carrier channel spacing frequency range if Ref Chan type is Left & Right Carriers. 6. Peak frequency in the right ref carrier channel spacing frequency range if Ref Chan type is Left & Right Carriers. Otherwise –999.0 is returned. 7. Reserved for the future use, returns –999.0 8. Reserved for the future use, returns –999.0 9. Reserved for the future use, returns –999.0 10. Reserved for the future use, returns –999.0 11. Relative integrated power on the negative offset A (dBc) 12. Absolute integrated power on the negative offset A (dBm/Hz) 13. Relative peak power on the negative offset A (dBc) 14. Absolute peak power on the negative offset A (dBm/Hz) 15. Peak power offset frequency from the center or carrier edge frequency in the negative offset A, depending on Offset Frequency Define settings (Hz) 16. Relative integrated power on the positive offset A (dBc) 17. Absolute integrated power on the positive offset A (dBm/Hz) 18. Relative peak power on the positive offset A (dBc) 19. Absolute peak power on the positive offset A (dBm/Hz) 20. Peak power offset frequency from the center or carrier edge frequency in the positive offset A, depending on Offset Frequency Define settings (Hz) 21. Relative integrated power on the negative offset B (dBc) ... 69. Absolute peak power on the positive offset F (dBm/Hz) 70. Peak power offset frequency from the center or carrier edge frequency in the positive offset F, depending on Offset Frequency Define settings (Hz)

Command		Return Value
	N=1	71. Minimum margin from limit line on the negative offset A (dB) 72. Minimum margin from limit line on the positive offset A (dB) 73. Minimum margin from limit line on the negative offset B (dB) 74. Minimum margin from limit line on the positive offset B (dB) 75. Minimum margin from limit line on the negative offset C (dB) 76. Minimum margin from limit line on the positive offset C (dB) 77. Minimum margin from limit line on the negative offset D (dB) 78. Minimum margin from limit line on the positive offset D (dB) 79. Minimum margin from limit line on the negative offset E (dB) 80. Minimum margin from limit line on the positive offset E (dB) 81. Minimum margin from limit line on the negative offset F (dB) 82. Minimum margin from limit line on the positive offset F (dB)

Command		Return Value
In MSR mode	N=1	<p>Result Summary (6 offsets), Meas Type: Spectrum Pk Ref.</p> <p>In case the Meas Type is: Spectrum Peak Reference</p> <p>Returns 82 comma-separated scalar results, in the following order:</p> <ol style="list-style-type: none"> 1. Total Absolute power of carriers of Measure Carrier On if available.. Otherwise –999.0 is returned. 2. Peak power at the reference carrier. Peak power at the left reference carrier if Ref Chan type is Left & Right Carriers. (dBm) 3. Peak power at the right reference carrier if Ref Chan type is Left & Right Carriers. (dBm). Otherwise –999.0 is returned. 4. Reserved for the future use, returns –999.0 5. Peak frequency in the ref carrier channel spacing frequency range . Peak frequency in the left ref carrier channel spacing frequency range if Ref Chan type is Left & Right Carriers. 6. Peak frequency in the right ref carrier channel spacing frequency range if Ref Chan type is Left & Right Carriers. Otherwise –999.0 is returned. 7. Reserved for the future use, returns –999.0 8. Reserved for the future use, returns –999.0 9. Reserved for the future use, returns –999.0 10. Reserved for the future use, returns –999.0 11. Relative integrated power on the negative offset A (dBc) 12. Absolute integrated power on the negative offset A (dBm) 13. Relative peak power on the negative offset A (dBc) 14. Absolute peak power on the negative offset A (dBm) 15. Peak power offset frequency from the center or carrier edge frequency in the negative offset A, depending on Offset Frequency Define settings (Hz) 16. Relative integrated power on the positive offset A (dBc) 17. Absolute integrated power on the positive offset A (dBm) 18. Relative peak power on the positive offset A (dBc) 19. Absolute peak power on the positive offset A (dBm) 20. Peak power offset frequency from the center or carrier edge frequency in the positive offset A, depending on Offset Frequency Define settings (Hz) 21. Relative integrated power on the negative offset B (dBc) ... 69. Absolute peak power on the positive offset F (dBm) 70. Peak power offset frequency from the center or carrier edge frequency in the positive offset F, depending on Offset Frequency Define settings (Hz)

Command		Return Value
	N=1	71. Minimum margin from limit line on the negative offset A (dB) 72. Minimum margin from limit line on the positive offset A (dB) 73. Minimum margin from limit line on the negative offset B (dB) 74. Minimum margin from limit line on the positive offset B (dB) 75. Minimum margin from limit line on the negative offset C (dB) 76. Minimum margin from limit line on the positive offset C (dB) 77. Minimum margin from limit line on the negative offset D (dB) 78. Minimum margin from limit line on the positive offset D (dB) 79. Minimum margin from limit line on the negative offset E (dB) 80. Minimum margin from limit line on the positive offset E (dB) 81. Minimum margin from limit line on the negative offset F (dB) 82. Minimum margin from limit line on the positive offset F (dB)
	N=2	Returns the displayed frequency domain spectrum trace data separated by comma. The number of data is 2001.
	N=3	Returns the displayed frequency domain absolute limit trace data separated by comma. The number of data is 2001.
	N=4	Returns the displayed frequency domain relative limit trace data separated by comma. The number of data is 2001.

Command		Return Value
	N=5	<p>In case the Meas Type is: Total Power Reference</p> <p>Returns 14 comma-separated scalar values (in dBm) of the absolute integrated power of the segment frequencies:</p> <ol style="list-style-type: none"> 1. Total power reference (dBm) 2. Reserved for the future use, returns -999.0 3. Absolute integrated power at negative offset frequency (A) 4. Absolute integrated power at positive offset frequency (A) ... 13. Absolute integrated power at negative offset frequency (F) 14. Absolute integrated power at positive offset frequency (F) <p>In MSR mode.</p> <p>Returns 26 comma-separated scalar values (in dBm) of the absolute integrated power of the segment frequencies:</p> <ol style="list-style-type: none"> 1. Ref carrier power. Left ref carrier power if Ref channel type is Left & Right (dBm) 2. Right ref carrier power if Ref channel type is Left & Right (dBm). Otherwise -999.0 is returned. 3. Absolute integrated power at negative offset frequency (A) 4. Absolute integrated power at positive offset frequency (A) ... 25. Absolute integrated power at negative offset frequency (L) 26. Absolute integrated power at positive offset frequency (L) <p>If the result is not available, -999.0 is returned. Number of returned values might be changed in future releases.</p>

Command		Return Value
	N=5	<p>In case the Meas Type is: Power Spectral Density Reference</p> <p>Returns 14 comma-separated scalar values (in dBm/Hz) of the absolute integrated power of the segment frequencies. Returns –999.0 for the offsets if in WLAN:</p> <ol style="list-style-type: none"> 1. Power spectral density reference (dBm/Hz) 2. Reserved for the future use, returns –999.0 3. Absolute integrated power at negative offset frequency (A) 4. Absolute integrated power at positive offset frequency (A) ... 13. Absolute integrated power at negative offset frequency (F) 14. Absolute integrated power at positive offset frequency (F) <p>In MSR mode.</p> <p>Returns 26 comma-separated scalar values (in dBm/Hz) of the absolute integrated power of the segment frequencies:</p> <ol style="list-style-type: none"> 1. Ref carrier power. Left ref carrier power if Ref channel type is Left & Right (dBm/Hz) 2. Right ref carrier power if Ref channel type is Left & Right (dBm/Hz). Otherwise –999.0 is returned. 3. Absolute integrated power at negative offset frequency (A) 4. Absolute integrated power at positive offset frequency (A) ... 25. Absolute integrated power at negative offset frequency (L) 26. Absolute integrated power at positive offset frequency (L) <p>If the result is not available, –999.0 is returned. Number of returned values might be changed in future releases.</p>

Command		Return Value
	N=5	<p>In case the Meas Type is: Spectrum Peak Reference</p> <p>Returns 14 comma-separated scalar values (in dBm) of the absolute peak power of the segment frequencies.</p> <ol style="list-style-type: none"> 1. Spectrum Peak Power reference (dBm) 2. Reserved for the future use, returns -999.0 3. Absolute peak power at negative offset frequency (A) 4. Absolute peak power at positive offset frequency (A) ... 13. Absolute peak power at negative offset frequency (F) 14. Absolute peak power at positive offset frequency (F) <p>In MSR mode.</p> <p>Returns 26 comma-separated scalar values (in dBm) of the absolute peak power of the segment frequencies.</p> <ol style="list-style-type: none"> 1. Spectrum Peak Power reference of ref carrier . Spectrum Peak Power reference of left ref carrier if Ref channel type is Left & Right (dBm) 2. Spectrum Peak Power reference of right ref carrier power if Ref channel type is Left & Right (dBm). Otherwise -999.0 is returned. 3. Absolute integrated power at negative offset frequency (A) 4. Absolute integrated power at positive offset frequency (A) ... 25. Absolute integrated power at negative offset frequency (L) 26. Absolute integrated power at positive offset frequency (L) <p>If the result is not available, -999.0 is returned. Number of returned values might be changed in future releases.</p>

Command		Return Value
	N=6	<p>In case the Meas Type is: Total Power Reference</p> <p>Returns 14 comma-separated scalar values (in dBc) of the integrated power relative to the carrier at the segment frequencies:</p> <ol style="list-style-type: none"> 1. Reserved for the future use, returns –999.0 2. Reserved for the future use, returns –999.0 3. Relative integrated power at negative offset frequency (A) 4. Relative integrated power at positive offset frequency (A) ... 13. Relative integrated power at negative offset frequency (F) 14. Relative integrated power at positive offset frequency (F) <p>In MSR mode.</p> <p>Returns 26 comma-separated scalar values (in dBc) of the integrated power relative to the carrier at the segment frequencies:</p> <ol style="list-style-type: none"> 1. Reserved for the future use, returns –999.0 2. Reserved for the future use, returns –999.0 3. Relative integrated power at negative offset frequency (A) 4. Relative integrated power at positive offset frequency (A) ... 25. Relative integrated power at negative offset frequency (L) 26. Relative integrated power at positive offset frequency (L) <p>If the result is not available, –999.0 is returned. Number of returned values might be changed in future releases.</p>

Command		Return Value
	N=6	<p>In case the Meas Type is: Power Spectral Density Reference</p> <p>Returns 14 comma-separated scalar values (in dBc/Hz) of the integrated power relative to the carrier at the segment frequencies. Returns -999.0 for the offsets if in WLAN:</p> <ol style="list-style-type: none"> 1. Reserved for the future use, returns -999.0 2. Reserved for the future use, returns -999.0 3. Relative integrated power at negative offset frequency (A) 4. Relative integrated power at positive offset frequency (A) ... 13. Relative integrated power at negative offset frequency (F) 14. Relative integrated power at positive offset frequency (F) <p>In MSR mode.</p> <p>Returns 26 comma-separated scalar values (in dBc/Hz) of the integrated power relative to the carrier at the segment frequencies.</p> <ol style="list-style-type: none"> 1. Reserved for the future use, returns -999.0 2. Reserved for the future use, returns -999.0 3. Relative integrated power at negative offset frequency (A) 4. Relative integrated power at positive offset frequency (A) ... 25. Relative integrated power at negative offset frequency (L) 26. Relative integrated power at positive offset frequency (L) <p>If the result is not available, -999.0 is returned. Number of returned values might be changed in future releases.</p>

Command		Return Value
	N=6	<p>In case the Meas Type is: Spectrum Peak Reference</p> <p>Returns 14 comma-separated scalar values (in dB) of the integrated power relative to the carrier at the segment frequencies.</p> <ol style="list-style-type: none"> 1. Reserved for the future use, returns –999.0 2. Reserved for the future use, returns –999.0 3. Relative peak power at negative offset frequency (A) 4. Relative peak power at positive offset frequency (A) ... 13. Relative peak power at negative offset frequency (F) 14. Relative peak power at positive offset frequency (F) <p>In MSR mode.</p> <p>Returns 26 comma-separated scalar values (in dB) of the integrated power relative to the carrier at the segment frequencies.</p> <ol style="list-style-type: none"> 1. Reserved for the future use, returns –999.0 2. Reserved for the future use, returns –999.0 3. Relative peak power at negative offset frequency (A) 4. Relative peak power at positive offset frequency (A) ... 25. Relative peak power at negative offset frequency (L) 26. Relative peak power at positive offset frequency (L) <p>If the result is not available, –999.0 is returned. Number of returned values might be changed in future releases.</p>

Command		Return Value
	N=7	<p>Returns 14 comma-separated pass/fail test results (0=passed, or 1=failed) determined by testing the minimum margin point from the limit line that is determined each offset's Limits setting.</p> <ol style="list-style-type: none"> 1. Reserved for the future use, returns -999.0 2. Reserved for the future use, returns -999.0 3. At negative offset frequency (A) 4. At positive offset frequency (A) ... 13. At negative offset frequency (F) 14. At positive offset frequency (F) <p>In MSR mode.</p> <p>Returns 26 comma-separated pass/fail test results (0=passed, or 1=failed) determined by testing the minimum margin point from the limit line that is determined each offset's Limits setting.</p> <ol style="list-style-type: none"> 1. Reserved for the future use, returns -999.0 2. Reserved for the future use, returns -999.0 3. At negative offset frequency (A) 4. At positive offset frequency (A) ... 25. At negative offset frequency (L) 26. At positive offset frequency (L) <p>Number of returned values might be changed in future releases.</p>

Command	Return Value
	<p data-bbox="521 289 1414 384">N=8 Returns 14 comma-separated pass/fail test results (0=passed, or 1=failed) determined by testing the minimum margin point from the limit line that is determined each offset's Limits setting.</p> <hr/> <p data-bbox="613 447 1409 478">NOTE The results for N=8 are the same as those for N=7.</p> <hr/> <p data-bbox="613 510 1097 541">1. Reserved for the future use, returns -999.0</p> <p data-bbox="613 558 1097 590">2. Reserved for the future use, returns -999.0</p> <p data-bbox="613 606 992 638">3. At negative offset frequency (A)</p> <p data-bbox="613 655 984 686">4. At positive offset frequency (A)</p> <p data-bbox="613 703 643 735">...</p> <p data-bbox="613 751 1000 783">13. At negative offset frequency (F)</p> <p data-bbox="613 800 992 831">14. At positive offset frequency (F)</p> <p data-bbox="613 848 776 879">In MSR mode.</p> <p data-bbox="613 896 1414 991">Returns 26 comma-separated pass/fail test results (0=passed, or 1=failed) determined by testing the minimum margin point from the limit line that is determined each offset's Limits setting.</p> <hr/> <p data-bbox="613 1054 1409 1085">NOTE The results for N=8 are the same as those for N=7.</p> <hr/> <p data-bbox="613 1117 1097 1148">1. Reserved for the future use, returns -999.0</p> <p data-bbox="613 1165 1097 1197">2. Reserved for the future use, returns -999.0</p> <p data-bbox="613 1213 992 1245">3. At negative offset frequency (A)</p> <p data-bbox="613 1262 984 1293">4. At positive offset frequency (A)</p> <p data-bbox="613 1310 643 1341">...</p> <p data-bbox="613 1358 1000 1390">25. At negative offset frequency (L)</p> <p data-bbox="613 1407 992 1438">26. At positive offset frequency (L)</p> <p data-bbox="613 1480 1292 1512">Number of returned values might be changed in future releases.</p>

Command		Return Value
	N=9	<p>Returns 14 comma-separated scalar values of frequency (in Hz) that have peak power from center or carrier edge frequency in each offset, depending on Offset Frequency Define settings.</p> <ol style="list-style-type: none"> 1. Reserved for the future use, returns -999.0 2. Reserved for the future use, returns -999.0 3. Negative offset frequency (A) 4. Positive offset frequency (A) ... 13. Negative offset frequency (F) 14. Positive offset frequency (F) <p>In MSR mode.</p> <p>Returns 26 comma-separated scalar values of frequency (in Hz) that have peak power from center or carrier edge frequency in each offset, depending on Offset Frequency Define settings.</p> <ol style="list-style-type: none"> 1. Reserved for the future use, returns -999.0 2. Reserved for the future use, returns -999.0 3. Negative offset frequency (A) 4. Positive offset frequency (A) ... 25. Negative offset frequency (L) 26. Positive offset frequency (L) <p>If the result is not available, -999.0 is returned. Number of returned values might be changed in future releases.</p>

Command		Return Value
	N=10	<p>Returns 14 comma-separated scalar values (in dBm) of the absolute peak power of the segment frequencies:</p> <ol style="list-style-type: none"> 1. Reserved for the future use, returns -999.0 2. Reserved for the future use, returns -999.0 3. At negative offset frequency (A) 4. At positive offset frequency (A) ... 13. At negative offset frequency (F) 14. At positive offset frequency (F) <p>In MSR mode.</p> <p>Returns 26 comma-separated scalar values (in dBm) of the absolute peak power of the segment frequencies:</p> <ol style="list-style-type: none"> 1. Reserved for the future use, returns -999.0 2. Reserved for the future use, returns -999.0 3. At negative offset frequency (A) 4. At positive offset frequency (A) ... 25. At negative offset frequency (L) 26. At positive offset frequency (L) <p>If the result is not available, -999.0 is returned. Number of returned values might be changed in future releases.</p>

Command		Return Value
	N=11	<p>Returns 14 comma-separated scalar values in dBc (dB if MeasType = PSD) of the peak power relative to the carrier at the segment frequencies:</p> <ol style="list-style-type: none"> 1. Reserved for the future use, returns -999.0 2. Reserved for the future use, returns -999.0 3. At negative offset frequency (A) 4. At positive offset frequency (A) ... 13. At negative offset frequency (F) 14. At positive offset frequency (F) <p>In MSR mode.</p> <p>Returns 26 comma-separated scalar values in dBc (dB if MeasType = PSD) of the peak power relative to the carrier at the segment frequencies:</p> <ol style="list-style-type: none"> 1. Reserved for the future use, returns -999.0 2. Reserved for the future use, returns -999.0 3. At negative offset frequency (A) 4. At positive offset frequency (A) ... 25. At negative offset frequency (L) 26. At positive offset frequency (L) <p>If the result is not available, -999.0 is returned. Number of returned values might be changed in future releases.</p>
	N=12	<p>Returns the power result (the peak power of the signal in the ref channel) when Meas Type is Spectrum Peak reference. Otherwise, the value returned will be -999.0</p>
(Available only in MSR)	N=13	<p>In case the Meas Type is: Total Power Reference</p> <p>Returns 5 comma-separated scalar results, in the following order:</p> <ol style="list-style-type: none"> 1. Total Absolute power of carriers of Measure Carrier On if available. (dBm) Otherwise NaN (9.91E+37). 2. Absolute power at the reference carrier. Absolute power at the left reference carrier if Ref Chan type is Left & Right Carriers. (dBm) 3. Absolute power at the right reference carrier if Ref Chan type is Left & Right Carriers. (dBm). Otherwise NaN (9.91E+37). 4. Peak frequency in the measured ref carrier frequency range. Peak frequency in the left ref carrier frequency range if Ref Chan type is Left & Right Carriers. (Hz) 5. Peak frequency in the right ref carrier frequency range if Ref Chan type is Left & Right Carriers. (Hz) Otherwise NaN (9.91E+37) is returned. <p>If the result is not available, NaN (9.91E+37) is returned. Number of returned values might be changed in future releases.</p>

Command		Return Value
(Available only in MSR)	N=13	<p>In case the Meas Type is: Power Spectral Density Reference</p> <p>Returns 5 comma-separated scalar results, in the following order:</p> <ol style="list-style-type: none"> 1. Total Absolute power of carriers of Measure Carrier On if available. (dBm) Otherwise NaN (9.91E+37). 2. Absolute power at the reference carrier. Absolute power at the left reference carrier if Ref Chan type is Left & Right Carriers. (dBm/Hz) 3. Absolute power at the right reference carrier if Ref Chan type is Left & Right Carriers. (dBm/Hz). Otherwise NaN (9.91E+37). 4. Peak frequency in the measured ref carrier frequency range. Peak frequency in the left ref carrier frequency range if Ref Chan type is Left & Right Carriers. (Hz) 5. Peak frequency in the right ref carrier frequency range if Ref Chan type is Left & Right Carriers. (Hz) Otherwise NaN (9.91E+37) is returned. <p>If the result is not available, NaN (9.91E+37) is returned. Number of returned values might be changed in future releases.</p>
(Available only in MSR)	N=13	<p>In case the Meas Type is: Power Spectrum Peak Reference</p> <p>Returns 5 comma-separated scalar results, in the following order:</p> <ol style="list-style-type: none"> 1. Total Absolute power of carriers of Measure Carrier On if available. (dBm) Otherwise NaN (9.91E+37). 2. Absolute power at the reference carrier. Absolute power at the left reference carrier if Ref Chan type is Left & Right Carriers. (dBm) 3. Absolute power at the right reference carrier if Ref Chan type is Left & Right Carriers. (dBm). Otherwise NaN (9.91E+37). 4. Peak frequency in the measured ref carrier frequency range. Peak frequency in the left ref carrier frequency range if Ref Chan type is Left & Right Carriers. (Hz) 5. Peak frequency in the right ref carrier frequency range if Ref Chan type is Left & Right Carriers. (Hz) Otherwise NaN (9.91E+37) is returned. <p>If the result is not available, NaN (9.91E+37) is returned. Number of returned values might be changed in future releases.</p>

Command		Return Value
(Available only in MSR)	N=14	<p>In MSR mode.</p> <p>In case the Meas Type is: Total Power Reference</p> <p>Returns 120 comma-separated scalar results, in the following order:</p> <ol style="list-style-type: none"> 1. Relative integrated power on the negative offset A (dBc) 2. Absolute integrated power on the negative offset A (dBm) 3. Relative peak power on the negative offset A (dBc) 4. Absolute peak power on the negative offset A (dBm) 5. Peak power offset frequency from the center or carrier edge frequency in the negative offset A, depending on Offset Frequency Define settings (Hz) 6. Relative integrated power on the positive offset A (dBc) 7. Absolute integrated power on the positive offset A (dBm) 8. Relative peak power on the positive offset A (dBc) 9. Absolute peak power on the positive offset A (dBm) 10. Peak power offset frequency from the center or carrier edge frequency in the positive offset A, depending on Offset Frequency Define settings (Hz) 11. Relative integrated power on the negative offset B (dBc) ... 119. Absolute peak power on the positive offset L (dBm) 120. Peak power offset frequency from the center or carrier edge frequency in the positive offset L, depending on Offset Frequency Define settings (Hz) <p>If the result is not available, NaN (9.91E+37) is returned. Number of returned values might be changed in future releases.</p>

Command		Return Value
(Available only in MSR)	N=14	<p>In MSR mode.</p> <p>In case the Meas Type is: Power Spectral Density Reference</p> <p>Returns 120 comma-separated scalar results, in the following order:</p> <ol style="list-style-type: none"> 1. Relative integrated power on the negative offset A (dB) 2. Absolute integrated power on the negative offset A (dBm/Hz) 3. Relative peak power on the negative offset A (dB) 4. Absolute peak power on the negative offset A (dBm/Hz) 5. Peak power offset frequency from the center or carrier edge frequency in the negative offset A, depending on Offset Frequency Define settings (Hz) 6. Relative integrated power on the positive offset A (dB) 7. Absolute integrated power on the positive offset A (dBm/Hz) 8. Relative peak power on the positive offset A (dB) 9. Absolute peak power on the positive offset A (dBm/Hz) 10. Peak power offset frequency from the center or carrier edge frequency in the positive offset A, depending on Offset Frequency Define settings (Hz) 11. Relative integrated power on the negative offset B (dB) ... 119. Absolute peak power on the positive offset L (dBm/Hz) 120. Peak power offset frequency from the center or carrier edge frequency in the positive offset L, depending on Offset Frequency Define settings (Hz) <p>If the result is not available, NaN (9.91E+37) is returned. Number of returned values might be changed in future releases.</p>

Command		Return Value
(Available only in MSR)	N=14	<p>In MSR mode.</p> <p>In case the Meas Type is: Spectrum Peak Reference</p> <p>Returns 120 comma-separated scalar results, in the following order:</p> <ol style="list-style-type: none"> 1. Reserved for the future use, returns NaN (9.91E+37) 2. Reserved for the future use, returns NaN (9.91E+37) 3. Relative peak power on the negative offset A (dB) 4. Absolute peak power on the negative offset A (dBm) 5. Peak power offset frequency from the center or carrier edge frequency in the negative offset A, depending on Offset Frequency Define settings (Hz) 6. Reserved for the future use, returns NaN (9.91E+37) 7. Reserved for the future use, returns NaN (9.91E+37) 8. Relative peak power on the positive offset A (dB) 9. Absolute peak power on the positive offset A (dBm) 10. Peak power offset frequency from the center or carrier edge frequency in the positive offset A, depending on Offset Frequency Define settings (Hz) 11. Relative integrated power on the negative offset B (dB) ... 119. Absolute peak power on the positive offset L (dBm) 120. Peak power offset frequency from the center or carrier edge frequency in the positive offset L, depending on Offset Frequency Define settings (Hz) <p>If the result is not available, NaN (9.91E+37) is returned. Number of returned values might be changed in future releases.</p>
(Available only in MSR)	N=15	<p>In MSR mode.</p> <p>In case the Meas Type is: Total Power Reference</p> <p>Returns 24 comma-separated scalar results, in the following order:</p> <ol style="list-style-type: none"> 1. Minimum margin from limit line on the negative offset A (dB) 2. Minimum margin from limit line on the positive offset A (dB) 3. Minimum margin from limit line on the negative offset B (dB) 4. Minimum margin from limit line on the positive offset B (dB) ... 23. Minimum margin from limit line on the negative offset L (dB) 24. Minimum margin from limit line on the positive offset L (dB) <p>If the result is not available, NaN (9.91E+37) is returned. Number of returned values might be changed in future releases.</p>

Command		Return Value
(Available only in MSR)	N=16	<p>In MSR mode.</p> <p>Returns number of carriers comma-separated scalar results, in the following order:</p> <ol style="list-style-type: none"> 1. Absolute power of carrier 1 (dBm) 2. Absolute power of carrier 2(dBm) ... number of carriers-1. Absolute power of carrier (number of carriers)-1 (dBm) number of carriers. Absolute power of carrier (number of carriers)-1 (dBm) <p>If Measure Carrier of the corresponding carrier is no, NaN (9.91E+37) is returned.</p>

Key Path	Meas
Initial S/W Revision	Prior to A.02.00

AMPTD Y Scale

Accesses a menu of functions that enable you to set the vertical scale parameters. The parameter values are measurement independent except all Attenuation values and Internal Preamp selections that are measurement global.

Key Path	Front-panel key
Initial S/W Revision	Prior to A.02.00

Ref Value

Sets the value for the absolute power reference. However, since Auto Scaling is defaulted to On, this value is automatically determined by the measurement result. When you set a value manually, Auto Scaling automatically changes to Off.

Key Path	AMPTD Y Scale
Mode	SA, WCDMA, C2K, WIMAX OFDMA, TD-SCDMA, 1xEVDO, DTMB (CTTB), DVB-T/H, ISDB-T, CMMB, LTE, LTETDD, Digital Cable TV, WLAN, MSR
Remote Command	:DISPlay:SEMask:VIEW[1]:WINDow[1]:TRACe:Y[:SCALE]:RLEVe l <real> :DISPlay:SEMask:VIEW[1]:WINDow[1]:TRACe:Y[:SCALE]:RLEVe l?
Example	DISP:SEM:VIEW:WIND:TRAC:Y:RLEV 100 DISP:SEM:VIEW:WIND:TRAC:Y:RLEV?
Notes	You must be in the mode that includes SEM measurement to use this command. Use :INSTrument:SELEct to set the mode.
Couplings	When the Auto Scaling is On, this value is automatically determined by the measurement result. When you set a value manually, Auto Scaling automatically changed to Off.
Preset	10.0 dBm
State Saved	Saved in instrument state.
Min	-250 dBm
Max	250 dBm
Initial S/W Revision	Prior to A.02.00
Modified at S/W Revision	A.02.00, A.03.00

Attenuation

Accesses a menu of functions that enable you to change attenuation settings. This key has read-back text that describes the total attenuator value.

See AMPTD Y Scale, “Attenuation” on page 1381 for more information.

Scale/Div

Sets the units-per-division of the vertical scale in the logarithmic display. When Auto Scaling is On, the scale per division value is automatically determined by the measurement result. When you set a value manually, Auto Scaling automatically changes to Off.

Key Path	AMPTD Y Scale
Mode	SA, WCDMA, C2K, WIMAX OFDMA, TD-SCDMA, 1xEVDO, DTMB (CTTB), DVB-T/H, ISDB-T, CMMB, LTE, LTETDD, Digital Cable TV, WLAN, MSR
Remote Command	:DISPlay:SEMask:VIEW[1]:WINDow[1]:TRACe:Y[:SCALE]:PDIVi sion <rel_ampl> :DISPlay:SEMask:VIEW[1]:WINDow[1]:TRACe:Y[:SCALE]:PDIVi sion?
Example	DISP:SEM:VIEW:WIND:TRAC:Y:PDIV 15dB DISP:SEM:VIEW:WIND:TRAC:Y:PDIV?
Notes	You must be in the mode that includes SEM measurement to use this command. Use :INSTrument:SElect to set the mode.
Couplings	When the Auto Scaling is On, this value is automatically determined by the measurement result. When you set a value manually, Auto Scaling automatically changes to Off.
Preset	10 dB
State Saved	Saved in instrument state
Min	0.10 dB
Max	20.00 dB
Initial S/W Revision	Prior to A.02.00
Modified at S/W Revision	A.02.00, A.03.00

Presel Center

See AMPTD Y Scale, “Presel Center” on page 1396 for more information.

Presel Adjust

See AMPTD Y Scale, “Preselector Adjust” on page 1398 for more information.

Y Axis Unit

Allows you to change the vertical (Y) axis amplitude unit.

See “[Y Axis Unit](#)” on page 1399 under AMPTD Y Scale for more information.

Key Path	AMPTD Y Scale
Initial S/W Revision	A.04.00

Reference Level Offset

Adds an offset value to the displayed reference level. The reference level is the absolute amplitude represented by the top graticule line on the display.

See “[Reference Level Offset](#)” on page 1404 under AMPTD Y Scale for more information.

Key Path	AMPTD Y Scale
Initial S/W Revision	A.04.00

mW Path Control

The **μW Path Control** functions include the **μW Preselector Bypass** (Option MPB) and **Low Noise Path** (Option LNP) controls in the High Band path circuits.

See μ“[μW Path Control](#)” on page 1405 under AMPTD Y Scale for more information.

Key Path	AMPTD Y Scale
Initial S/W Revision	A.04.00

Internal Preamp

Accesses a menu of functions that enable you to control the internal preamplifiers.

See AMPTD Y Scale, “[Internal Preamp](#)” on page 1410 for more information.

Ref Position

Positions the reference level at the top, center or bottom of the Y scale display. Changing the reference position does not affect the reference level value.

Key Path	AMPTD Y Scale
Mode	SA, WCDMA, C2K, WIMAX OFDMA, TD-SCDMA, 1xEVDO, DTMB (CTTB), DVB-T/H, ISDB-T, CMMB, LTE, LTETDD, Digital Cable TV, WLAN, MSR

Remote Command	:DISPlay:SEMask:VIEW[1]:WINDow[1]:TRACe:Y[:SCALe]:RPOSi tion TOP CENTer BOTTom :DISPlay:SEMask:VIEW[1]:WINDow[1]:TRACe:Y[:SCALe]:RPOSi tion?
Example	DISP:SEM:VIEW:WIND:TRAC:Y:RPOS BOTT DISP:SEM:VIEW:WIND:TRAC:Y:RPOS?
Notes	You must be in the mode that includes SEM measurement to use this command. Use :INSTrument:SELEct to set the mode.
Preset	TOP
State Saved	Saved in instrument state
Range	Top Ctr Bot
Initial S/W Revision	Prior to A.02.00
Modified at S/W Revision	A.02.00, A.03.00

Auto Scaling

Toggles the Auto Scaling function between On and Off.

When Auto Scaling is On and the Restart front-panel key is pressed, the analyzer automatically determines the scale per division and reference values based on the measurement results. When you set a value to either Scale/Div or Ref Value manually, Auto Scaling automatically changes to Off.

Key Path	AMPTD Y Scale
Mode	SA, WCDMA, C2K, WIMAX OFDMA, TD-SCDMA, 1xEVDO, DTMB (CTTB), DVB-T/H, ISDB-T, CMMB, LTE, LTETDD, Digital Cable TV, WLAN, MSR
Remote Command	:DISPlay:SEMask:VIEW[1]:WINDow[1]:TRACe:Y[:SCALe]:COUPl e 0 1 ON OFF :DISPlay:SEMask:VIEW[1]:WINDow[1]:TRACe:Y[:SCALe]:COUPl e?
Example	DISP:SEM:VIEW:WIND:TRAC:Y:COUP OFF DISP:SEM:VIEW:WIND:TRAC:Y:COUP?
Notes	You must be in the mode that includes SEM measurement to use this command. Use :INSTrument:SELEct to set the mode.
Couplings	When Auto Scaling is On, upon pressing the Restart front-panel key, this function automatically determines the scale per division and reference values based on the measurement results. When you set a value to either Scale/Div or Ref Value manually, Auto Scaling automatically changes to Off.
Preset	ON

Spectrum Emission Mask Measurement
AMPTD Y Scale

State Saved	Saved in instrument state
Range	On Off
Initial S/W Revision	Prior to A.02.00
Modified at S/W Revision	A.02.00, A.03.00

Auto Couple

See [“Auto Couple” on page 1412](#) for more information.

Key Path	Front-panel key
Initial S/W Revision	Prior to A.02.00

BW

Accesses a menu of functions that enable you to select the type of filter for the measurement.

Key Path	Front-panel key
Initial S/W Revision	Prior to A.02.00
Modified at S/W Revision	A.03.00

Filter Type

Selects the type of bandwidth filter that is used in Carrier and Offsets.

When Gaussian or Flattop is selected, selected filter is applied to carriers and all offsets.

When Auto Sense is selected, filter type is automatically selected for each carriers and offsets, so that measurement speed and accuracy is optimized.

Key Path	BW
Mode	SA, WCDMA, C2K, WIMAX OFDMA, TD-SCDMA, 1xEVDO, DVB-T/H, DTMB (CTTB), ISDB-T, CMMB, LTE, LTETDD, Digital Cable TV, WLAN, MSR
Remote Command	[:SENSe] :SEMAsk :BANDwidth :SHAPE ASENse GAUSSian FLATtop [:SENSe] :SEMAsk :BANDwidth :SHAPE?
Example	SEM:BAND:SHAP GAUS SEM:BAND:SHAP?
Couplings	See the description above
Preset	ASENSE
State Saved	Saved in instrument state
Range	Auto Sense (each offset and carrier) Gaussian (all offsets and carriers) Flattop (all offsets and carriers)
Initial S/W Revision	A.03.00

Cont

See “[Cont \(Continuous Measurement/Sweep\)](#)” on page 1413 for more information.

Key Path	Front-panel key
Initial S/W Revision	Prior to A.02.00

FREQ Channel

See “FREQ Channel” on page 1414 for more information.

Key Path	Front-panel key
Initial S/W Revision	Prior to A.02.00

Input/Output

See “[Input/Output](#)” on page 1422 for more information.

Key Path	Front-panel key
Initial S/W Revision	Prior to A.02.00

Marker

Accesses a menu that enables you to select, set up and control the markers for the current measurement. If there are no active markers, **Marker** selects marker 1, sets it to Normal and places it at the center of the display. You can turn on and control up to 12 markers.

Key Path	Front-panel key
Initial S/W Revision	Prior to A.02.00

Select Marker

Displays 12 markers available for selection.

Key Path	Marker
Initial S/W Revision	Prior to A.02.00

Marker Type

Sets the marker control mode to Normal and Off. If the selected marker is Off, pressing Marker sets it to Normal and places it at the center of the screen on the trace determined by the **Marker Trace** rules. At the same time, **Marker X Axis Value** appears on the Active Function area. The marker X axis value entered in the active function area will display the marker value to its full entered precision. If the current control mode for the measurement is Off, there is no active function and the active function is turned off.

Key Path	Marker
Mode	SA, WCDMA, C2K, WIMAX OFDMA, TD-SCDMA, 1xEVDO, DTMB (CTTB), DVB-T/H, ISDB-T, CMMB, LTE, LTETDD, Digital Cable TV, WLAN, MSR
Remote Command	:CALCulate:SEMAsk:MARKer[1] 2 3 4 5 6 7 8 9 10 11 12:MODE POSITION OFF :CALCulate:SEMAsk:MARKer[1] 2 3 4 5 6 7 8 9 10 11 12:MODE?
Example	CALC:SEM:MARK:MODE POS CALC:SEM:MARK:MODE?
Notes	If the selected marker is Off, pressing Marker sets it to Normal and places it at the center of the screen on the trace determined by the Marker Trace rules. At the same time, Marker X Axis Value appears on the Active Function area. Default Active Function: the active function for the selected marker's current control mode. Note that if the current control mode is Off, there is no active function and the active function is turned off. Active Function Display: the marker X axis value entered in the active function area will display the marker value to its full entered precision.

Preset	OFF OFF OFF OFF OFF OFF OFF OFF OFF OFF OFF OFF
State Saved	Saved in instrument state
Range	Normal Off
Initial S/W Revision	Prior to A.02.00
Modified at S/W Revision	A.02.00, A.03.00

Marker X Axis Value (Remote Command Only)

Sets the marker X Axis value in the current marker X Axis Scale unit. It has no effect if the control mode is Off, but is the SCPI equivalent of entering an X value if the control mode is **Normal**.

Mode	SA, WCDMA, C2K, WIMAX OFDMA, TD-SCDMA, 1xEVDO, DTMB (CTTB), DVB-T/H ISDB-T, CMMB, LTE, LTETDD, Digital Cable TV, WLAN, MSR
Remote Command	:CALCulate:SEMask:MARKer[1] 2 3 4 5 6 7 8 9 10 11 12:X <freq> :CALCulate:SEMask:MARKer[1] 2 3 4 5 6 7 8 9 10 11 12:X?
Example	CALC:SEM:MARK3:X 1.0 GHz CALC:SEM:MARK3:X?
Notes	If no suffix is sent it will use the fundamental units for the current marker X Axis Scale. If a suffix is sent that does not match the current marker X Axis Scale unit, an error “Invalid suffix” will be generated. The query returns the marker’s absolute X Axis value if the control mode is Normal . The query is returned in the fundamental units for the current marker X Axis scale. If the marker is Off the response is not a number. When a Marker is turned on, it is placed center of the screen on the trace. Therefore the default value depends on instrument condition, although the Preset/Default is defined as 1.5 GHz.
Preset	After a preset, all Markers are turned OFF, so a Marker X Axis Value query will return a not a number (NAN).
State Saved	No
Min	-9.9E+37
Max	9.9E+37
Initial S/W Revision	Prior to A.02.00
Modified at S/W Revision	A.02.00, A.03.00

Marker X Axis Position (Remote Command Only)

Sets the marker X position in trace points. It has no effect if the control mode is **Off**, but is the SCPI equivalent of entering a value if the control mode is **Normal**, except in trace points rather than X Axis

Spectrum Emission Mask Measurement
Marker

Scale units. The entered value is immediately translated into the current X Axis Scale units for setting the value of the marker.

Mode	SA, WCDMA, C2K, WIMAX OFDMA, TD-SCDMA, 1xEVDO, DTMB (CTTB), DVB-T/H, ISDB-T, CMMB, LTE, LTETDD, Digital Cable TV, WLAN, MSR
Remote Command	:CALCulate:SEMask:MARKer[1] 2 3 4 5 6 7 8 9 10 11 12:X:POSition <real> :CALCulate:SEMask:MARKer[1] 2 3 4 5 6 7 8 9 10 11 12:X:POSition?
Example	CALC:SEM:MARK10:X:POS 1001 CALC:SEM:MARK10:X:POS?
Notes	The query returns the marker's absolute X Axis value in trace points if the control mode is Normal . The value is returned as a real number, not an integer, corresponding to the translation from X Axis Scale units to trace points . If the marker is Off the response is not a number. When a Marker is turned on, it is placed center of the screen on the trace. Therefore the default value depends on he instrument condition although the Preset/Default is defined as 6507 (this value might be the expected value when all the offsets are on).
Preset	After a preset, all Markers are turned OFF, so a Marker X Axis Value query will return a not a number (NAN).
State Saved	No
Min	-9.9E+37
Max	9.9E+37
Initial S/W Revision	Prior to A.02.00
Modified at S/W Revision	A.02.00, A.03.00

Marker Y Axis Value (Remote Command Only)

Returns the marker Y Axis value in the current marker Y Axis unit.

Mode	SA, WCDMA, C2K, WIMAX OFDMA, TD-SCDMA, 1xEVDO, DTMB (CTTB), DVB-T/H, ISDB-T, CMMB, LTE, LTETDD, Digital Cable TV, WLAN, MSR
Remote Command	:CALCulate:SEMask:MARKer[1] 2 3 4 5 6 7 8 9 10 11 12:Y?
Example	CALC:SEM:MARK11:Y 10 dBm CALC:SEM:MARK11:Y?
Notes	Since the result value is always calculated from acquisition data, the default value is arbitrary, although the Preset/Default values is defined.

Preset	Result dependent on markers setup and signal source
State Saved	No
Backwards Compatibility SCPI	:CALCulate:SEMask:MARKer[1] 2 3 4 5 6 7 8 9 10 11 12:FUNCTION:RESult?
Initial S/W Revision	Prior to A.02.00
Modified at S/W Revision	A.02.00, A.03.00

Couple Markers

When this function is true, moving any marker causes an equal X Axis movement of every other marker which is not **Off**. By “equal X Axis movement” we mean that we preserve the difference between each marker’s X Axis value (in the fundamental x-axis units of the trace that marker is on) and the X Axis value of the marker being moved (in the same fundamental x-axis units).

Key Path	Marker
Mode	SA, WCDMA, C2K, WIMAX OFDMA, TD-SCDMA, 1xEVDO, DTMB (CTTB), DVB-T/H, ISDB-T, CMMB, LTE, LTETDD, Digital Cable TV, WLAN, MSR
Remote Command	:CALCulate:SEMask:MARKer:COUPle[:STATe] ON OFF 1 0 :CALCulate:SEMask:MARKer:COUPle[:STATe]?
Example	CALC:SEM:MARK:COUP ON CALC:SEM:MARK:COUP?
Preset	OFF
State Saved	Saved in instrument state
Range	On Off
Initial S/W Revision	Prior to A.02.00
Modified at S/W Revision	A.02.00, A.03.00

All Markers Off

Turns all active markers off in all views.

Key Path	Marker
Mode	SA, WCDMA, C2K, WIMAX OFDMA, TD-SCDMA, 1xEVDO, DTMB (CTTB), DVB-T/H, ISDB-T, CMMB, LTE, LTETDD, Digital Cable TV, WLAN, MSR
Remote Command	:CALCulate:SEMask:MARKer:AOFF
Example	CALC:SEM:MARK:AOFF
Initial S/W Revision	Prior to A.02.00

Spectrum Emission Mask Measurement
Marker

Modified at S/W Revision	A.02.00, A.03.00
--------------------------	------------------

Marker Function

There are no 'Marker Functions' supported in Spectrum Emission Mask so this front-panel key will display a blank key menu when pressed.

Key Path	Front-panel key
Initial S/W Revision	Prior to A.02.00

Marker To

There is no 'Marker To' functionality supported in Spectrum Emission Mask so this front-panel key will display a blank key menu when pressed.

Key Path	Front-panel key
Initial S/W Revision	Prior to A.02.00

Meas

See “Meas” on page 1520 for more information.

Key Path	Front-panel key
Initial S/W Revision	Prior to A.02.00

Meas Setup

Displays the setup menu for the currently selected measurement.

Key Path	Front-panel key
Initial S/W Revision	Prior to A.02.00

Avg/Hold Num

Toggles averaging On or Off in addition to enabling you to set the number of measurement averages used to calculate the measurement result. The average will be displayed at the end of each sweep. After the specified number of average counts, the average mode (termination control) setting determines the average action.

In the remote mode, use the Average State command to turn averaging on or off.

Key Path	Meas Setup
Mode	SA, WCDMA, C2K, WIMAX OFDMA, TD-SCDMA, 1xEVDO, DTMB (CTTB), DVB-T/H, ISDB-T, CMMB, LTE, LTETDD, Digital Cable TV, WLAN, MSR
Remote Command	[:SENSe] :SEMAsk :AVERAge :COUNt <integer> [:SENSe] :SEMAsk :AVERAge :COUNt ? [:SENSe] :SEMAsk :AVERAge [:STATe] ON OFF 1 0 [:SENSe] :SEMAsk :AVERAge [:STATe] ?
Example	SEM:AVER:COUN 100 SEM:AVER:COUN? SEM:AVER ON SEM:AVER?
Notes	You must be in the mode that includes SEM measurement to use this command. Use :INSTRument:SELect to set the mode.
Preset	10 OFF
State Saved	Saved in instrument state.
Min	1
Max	10000
Initial S/W Revision	Prior to A.02.00
Modified at S/W Revision	A.02.00, A.03.00

Meas Type

Accesses a menu that enables you to select one of the following measurement reference types:

Total Pwr Ref – Sets the reference to the total carrier power and the measured data is shown in dBc and dBm.

PSD Ref – Sets the reference to the mean power spectral density of the carrier and the measured data is shown in dB and dBm/Hz.

Spectrum Peak Ref – Sets the reference to the spectrum peak power of the carrier and the measured data is shown in dB and dBm.

Key Path	Meas Setup
Mode	SA, WCDMA, C2K, WIMAX OFDMA, TD-SCDMA, 1xEVDO, DTMB (CTTB), DVB-T/H, ISDB-T, CMMB, LTE, LTETDD, Digital Cable TV, WLAN, MSR
Remote Command	[:SENSe] :SEMask :TYPE PSDRef TPreRef SPRef [:SENSe] :SEMask :TYPE ?
Example	SEM:TYPE PSDR SEM:TYPE?
Notes	You must be in the mode that includes SEM measurement to use this command. Use :INSTrument:SElect to set the mode.
Preset	SA, WCDMA, C2K, TD-SCDMA, 1xEVDO, DTMB (CTTB), DVB-T/H, ISDB-T, CMMB, LTE, LTETDD, Digital Cable TV, MSR: TPreRef WIMAX OFDMA, WLAN: SPRef
State Saved	Saved in instrument state.
Range	Total Pwr Ref PSD Ref Spectrum Peak Ref
Initial S/W Revision	Prior to A.02.00
Modified at S/W Revision	A.02.00, A.03.00

Ref Channel

Accesses a menu that enables you to set up the measurement parameters used to calculate the power in the reference channel.

Key Path	Meas Setup
Initial S/W Revision	Prior to A.02.00

Spectrum Emission Mask Measurement
Meas Setup

Integ BW

Specifies the integration bandwidth used to calculate the power in the reference channel.

Key Path	Meas Setup, Ref Channel
Mode	SA, WCDMA, C2K, WIMAX OFDMA, TD-SCDMA, 1xEVDO, DTMB (CTTB), DVB-T/H, ISDB-T, CMMB, LTE, LTETDD, Digital Cable TV, WLAN
Remote Command	[:SENSE] :SEMAsk:BAWdwidth[1] 2:INTEgration <bandwidth> [:SENSE] :SEMAsk:BAWdwidth[1] 2:INTEgration?
Example	SEM:BAWd:INT 10 MHz SEM:BAWd:INT?
Notes	10% . 100% of Channel Span Parameter Value Bandwidth sub op code, 1 is for BTS, 2 for MS. Default is BTS. You must be in the mode that includes SEM measurement to use this command. Use :INSTRument:SELect to set the mode.
Dependencies	For MSR mode, this key is blank.
Couplings	Cannot be higher than the channel Span. If lower than 1/10 of channel Span, then the channel Span is reduced to be 10 times the Integ BW.
Preset	SA: 3.84 MHz WCDMA: 3.84 MHz 3.84 MHz C2K: 1.23 MHz 1.23 MHz WIMAX OFDMA: 10 MHz 10 MHz TD-SCDMA: 1.28 MHz 1.28 MHz 1xEVDO: 1.23MHz DTMB (CTTB): 7.56MHz DVB-T/H: 7.61MHz ISDB-T: 5.6MHz CMMB: 7.512MHz LTE: 4.515MHz 4.5MHz LTETDD: 4.515MHz 4.5MHz Digital Cable TV: 6.9MHz WLAN: if Radio Std is 802.11a/g(OFDm/DSSS-OFDM)/802.11n(20MHz): 18 MHz if Radio Std is 802.11b/g(DSSS/CCK/PBCC): 22 MHz if Radio Std is 802.11n(40MHz): 38 MHz
State Saved	Saved in instrument state.

Min	1 kHz
Max	50 MHz
Initial S/W Revision	Prior to A.02.00
Modified at S/W Revision	A.02.00, A.03.00

Span

Specifies the span used to calculate the power in the reference channel.

Key Path	Meas Setup, Ref Channel
Mode	SA, WCDMA, C2K, WIMAX OFDMA, TD-SCDMA, 1xEVDO, DTMB (CTTB), DVB-T/H, ISDB-T, LTE, LTETDD, CMMB, Digital Cable TV, WLAN
Remote Command	[:SENSe] :SEMAsk :FREQuency [1] 2 :SPAN <freq> [:SENSe] :SEMAsk :FREQuency [1] 2 :SPAN?
Example	SEM:FREQ:SPAN 3MHz SEM:FREQ:SPAN?
Notes	Frequency sub op code, 1 is for BTS, 2 for MS. Default is BTS. You must be in the mode that includes SEM measurement to use this command. Use :INSTRument:SElect to set the mode.
Dependencies	For MSR mode, this key is blank.
Couplings	Range 1 kHz to 50 MHz (although restricted by Integ BW). If you set the channel Span lower than channel Integ BW, they will both track each other. As you increase the channel Span, the Integ BW will also increase if it is less than 1/10 of the channel Span.

Spectrum Emission Mask Measurement
Meas Setup

Preset	SA: 5.0 MHz WCDMA: 5.0 MHz 5.0 MHz C2K: 1.25 MHz 1.25 MHz WIMAX OFDMA: 10 MHz 10 MHz TD-SCDMA: 1.6 MHz 1.6 MHz 1xEVDO: 1.25 MHz DTMB (CTTB): 10 MHz DVB-T/H: 10 MHz ISDB-T: 8 MHz CMMB: 10 MHz LTE: 5 MHz LTETDD: 5 MHz Digital Cable TV: 10 MHz WLAN: if Radio Std is 802.11a/g(OFDM/DSSS-OFDM)/802.11n(20MHz): 18 MHz if Radio Std is 802.11b/g(DSSS/CCK/PBCC): 22 MHz if Radio Std is 802.11n(40MHz): 38 MHz
State Saved	Saved in instrument state.
Min	1 kHz
Max	50 MHz
Initial S/W Revision	Prior to A.02.00
Modified at S/W Revision	A.02.00, A.03.00

Sweep Time

Sets the sweep time used to calculate the power in the reference channel. Sweep Time can be set manually or put in auto mode.

Key Path	Meas Setup, Ref Channel
Mode	SA, WCDMA, C2K, WIMAX OFDMA, TD-SCDMA, 1xEVDO, DTMB (CTTB), DVB-T/H, ISDB-T, CMMB, LTE, LTETDD, Digital Cable TV, WLAN, MSR
Remote Command	[:SENSe] :SEMAsk :SWEep [1] 2 :TIME <time> [:SENSe] :SEMAsk :SWEep [1] 2 :TIME? [:SENSe] :SEMAsk :SWEep [1] 2 :TIME :AUTO OFF 0 ON 1 [:SENSe] :SEMAsk :SWEep [1] 2 :TIME :AUTO?

Example	SEM:SWE:TIME 9ms SEM:SWE:TIME? SEM:SWE:TIME:AUTO OFF SEM:SWE:TIME:AUTO?
Notes	Sweep Time sub op code, 1 is for BTS, 2 for MS. Default is BTS. You must be in the mode that includes SEM measurement to use this command. Use :INSTrument:SELEct to set the mode.
Couplings	When the Sweep Time is set manually, Auto is set to OFF. Value is coupled with Channel Detector selection, Channel Resolution BW, Channel Video BW if the state is Auto. When set to Auto, the Sweep Time is automatically calculated
Preset	Automatically calculated ON
State Saved	Saved in instrument state.
Min	1 ms
Max	4000 s
Initial S/W Revision	Prior to A.02.00
Modified at S/W Revision	A.02.00, A.03.00

Res BW

Sets the resolution bandwidth used to calculate the power in the reference channel. The Channel Resolution BW can be set manually or put in to auto mode.

MSR Auto RBW:

In the MSR resolution bandwidth is predefined for each radio format. When carriers are configured with multiple radio formats, the narrowest RBW is selected.

Radio Format		RBW (kHz)
LTE	1.4 MHz	13
	3 MHz	27
	5 MHz	47
	10 MHz	91
	15 MHz	150
	20 MHz	180
W-CDMA		75

Spectrum Emission Mask Measurement
Meas Setup

Radio Format	RBW (kHz)
GSM	30

Key Path	Meas Setup, Ref Channel
Mode	SA, WCDMA, C2K, WIMAX OFDMA, TD-SCDMA, 1xEVDO, DTMB (CTTB), DVB-T/H, ISDB-T, CMMB, LTE, LTETDD, Digital Cable TV, WLAN, MSR
Remote Command	<pre>[:SENSe]:SEMAsk:BA NDwidth[1] 2[:RESolution] <bandwidth> [:SENSe]:SEMAsk:BA NDwidth[1] 2[:RESolution]? [:SENSe]:SEMAsk:BA NDwidth[1] 2[:RESolution]:AUTO OFF ON 1 0 [:SENSe]:SEMAsk:BA NDwidth[1] 2[:RESolution]:AUTO?</pre>
Example	<pre>SEM:BA ND 100 kHz SEM:BA ND? SEM:BA ND:AUTO ON SEM:BA ND:AUTO?</pre>
Notes	<p>Bandwidth sub op code, 1 is for BTS, 2 for MS. Default is BTS.</p> <p>You must be in the mode that includes SEM measurement to use this command. Use :INSTrument:SELEct to set the mode.</p>
Couplings	<p>When Res BW is set manually, Channel Resolution BW Mode is set to MANual.</p> <p>Value is coupled with Channel Detector selection, Channel Sweep Time, Channel Video BW.</p> <p>When set to Auto, the resolution bandwidth is automatically calculated.</p>

Preset	SA: 100 kHz WCDMA: 75 kHz C2K: 24 kHz WIMAX OFDMA: 100 kHz TD-SCDMA: 30 kHz 1xEVDO: 30.0 KHz DTMB (CTTB): 3.9 kHz DVB-T/H: 3.9 kHz ISDB-T: 10 kHz CMMB: 3.9 kHz LTE, LTETDD, MSR:Auto (47 kHz) Digital Cable TV: 3.9 kHz WLAN: 100 kHz ON
State Saved	Saved in instrument state.
Min	1 Hz
Max	8 MHz
Backwards Compatibility SCPI	[[:SENSe]:SEMAsk:BWIDth[1]]2[:RESolution]
Initial S/W Revision	Prior to A.02.00
Modified at S/W Revision	A.02.00, A.03.00

Video BW

Sets the video bandwidth used to calculate the power in the reference channel. The Channel Video BW can be set manually or put in to auto mode.

Key Path	Meas Setup, Ref Channel
Mode	SA, WCDMA, C2K, WIMAX OFDMA, TD-SCDMA, 1xEVDO, DTMB (CTTB), DVB-T/H, ISDB-T, CMMB, LTE, LTETDD, Digital Cable TV, WLAN, MSR
Remote Command	[[:SENSe]:SEMAsk:BWIDth[1]]2:VIDeo <bandwidth> [[:SENSe]:SEMAsk:BWIDth[1]]2:VIDeo? [[:SENSe]:SEMAsk:BWIDth[1]]2:VIDeo:AUTO OFF ON 1 0 [[:SENSe]:SEMAsk:BWIDth[1]]2:VIDeo:AUTO?

Spectrum Emission Mask Measurement
Meas Setup

Example	SEM:BAND:VID 100 kHz SEM:BAND:VID? SEM:BAND:VID:AUTO ON SEM:BAND:VID:AUTO?
Notes	Bandwidth sub op code, 1 is for BTS, 2 for MS. Default is BTS. You must be in the mode that includes SEM measurement to use this command. Use :INSTrument:SELEct to set the mode.
Couplings	When Video BW is set manually, Channel Video BW Mode is set to MANual Value is coupled with Channel Detector selection, Channel Sweep Time, Channel Resolution BW. When set to Auto, the video bandwidth is automatically calculated.
Preset	SA: 100 kHz WCDMA: 75 kHz C2K: 24 kHz WIMAX OFDMA: 30 kHz TD-SCDMA: 300 kHz 1xEVDO: 300.0 kHz DTMB (CTTB): 39 kHz DVB-T/H: 39 kHz ISDB-T: 1 kHz CMMB: 39 kHz LTE, MSR: Auto LTETDD: Auto Digital Cable TV: 39 kHz WLAN: Auto ON
State Saved	Saved in instrument state.
Min	1 Hz
Max	50 MHz
Backwards Compatibility SCPI	[:SENSE]:SEMAsk:BWIDth[1] 2:VIDeo
Initial S/W Revision	Prior to A.02.00
Modified at S/W Revision	A.02.00, A.03.00

VBW/RBW

Sets the Video BW/Resolution BW Ratio to calculate the Channel Resolution BW and Channel Video

BW. The VBW/RBW Ratio can be set manually or put in to auto mode.

Key Path	Meas Setup, Ref Channel
Mode	SA, WCDMA, C2K, WIMAX OFDMA, TD-SCDMA mode, 1xEVDO, DTMB (CTTB), DVB-T/H, ISDB-T, CMMB, LTE, LTETDD, Digital Cable TV, WLAN, MSR
Remote Command	[:SENSe]:SEMAsk:BANDwidth[1] 2:VIDeo:RATio <real> [:SENSe]:SEMAsk:BANDwidth[1] 2:VIDeo:RATio [:SENSe]:SEMAsk:BANDwidth[1] 2:VIDeo:RATio:AUTO OFF ON 1 0 [:SENSe]:SEMAsk:BANDwidth[1] 2:VIDeo:RATio:AUTO?
Example	SEM:BAND:VID:RAT 0.1 SEM:BAND:VID:RAT? SEM:BAND:VID:RAT:AUTO ON SEM:BAND:VID:RAT:AUTO?
Notes	Bandwidth sub op code, 1 is for BTS, 2 for MS. Default is BTS. You must be in the mode that includes SEM measurement to use this command. Use :INSTrument:SELEct to set the mode.
Couplings	When Res BW is set manually, Mode coupling is set to MANual When set to Auto, the VBW/RBW Ratio is automatically calculated.
Preset	SA, WCDMA, C2K: 1.0 WIMAX OFDMA: 0.3 TD-SCDMA: 10 1xEVDO: 10.0 DTMB (CTTB): 10 DVB-T/H: 10 ISDB-T: 0.1 CMMB: 10 LTE, MSR: Auto LTETDD: Auto Digital Cable TV: 10 WLAN: Auto ON
State Saved	Saved in instrument state.
Min	0.00001
Max	3000000

Spectrum Emission Mask Measurement
Meas Setup

Backwards Compatibility SCPI	[[:SENSE]:SEMAsk:BWIDth[1]]2:VIDeo:RATio
Initial S/W Revision	Prior to A.02.00
Modified at S/W Revision	A.02.00, A.03.00

Power Ref (for the modes except MSR)

Sets the power reference in the carrier that will be used to compute the relative values for the offsets.

Key Path	Meas Setup, Ref Channel
Initial S/W Revision	Prior to A.02.00

Total Power

Sets the power in the carrier (ref channel) that will be used to compute the relative power values for the offsets. When the state is set to auto, this value is set to the measured carrier reference power. When set to manual, the result takes on the last measured value, or can be manually entered.

Key Path	Meas Setup, Ref Channel, Power Ref
Mode	SA, WCDMA, C2K, WIMAX OFDMA, TD-SCDMA, 1xEVDO, DTMB (CTTB), DVB-T/H, ISDB-T, CMMB, LTE, LTETDD, Digital Cable TV, WLAN, MSR
Remote Command	[[:SENSE]:SEMAsk:CARRier[:POWER] <real> [:SENSE]:SEMAsk:CARRier[:POWER]? [:SENSE]:SEMAsk:CARRier:AUTO[:STATe] OFF ON 1 0 [:SENSE]:SEMAsk:CARRier:AUTO[:STATe]?
Example	SEM:CARR 100dBm SEM:CARR? SEM:CARR:AUTO OFF SEM:CARR:AUTO?
Notes	The min and max values given are for Meas Type = Total Pwr Ref. You must be in the mode that includes SEM measurement to use this command. Use :INSTRument:SELEct to set the mode.. This BAF SCPI command is available in all the Meas Type case. This BAF SCPI command is not available in MSR mode.
Dependencies	This "Total Power Ref" parameter is coupled with the "Meas Type" parameter. The softkey would be active if the Meas Type is set to Total Power Ref. Otherwise, it is grayed out.
Preset	Measured carrier reference power
State Saved	Saved in instrument state.
Min	-200 dBm

Max	200 dBm
Initial S/W Revision	Prior to A.02.00
Modified at S/W Revision	A.02.00, A.03.00

PSD

Sets the power spectral density in the carrier that is used to compute the relative power spectral density values for the offsets when Meas Type is set to PSD Ref. When the state is set to auto, this will be set to the measured carrier power spectral density.

Key Path	Meas Setup, Ref Chan, Power Ref
Mode	SA, WCDMA, C2K , WIMAX OFDMA, TD-SCDMA, 1xEVDO, DTMB (CTTB), DVB-T/H, ISDB-T, CMMB, LTE, LTETDD, Digital Cable TV, WLAN, MSR
Remote Command	[:SENSe] :SEMAsk :CARRier :CPSD <real> [:SENSe] :SEMAsk :CARRier :CPSD?
Example	SEM:CARR:CPSD -80 SEM:CARR:CPSD?
Notes	Although the default value is defined, the value is recalculated by the measurement result just after completing the measurement. Carrier sub op code. 1 for BTS, 2 for MS. Default is BTS. You must be in the mode that includes SEM measurement to use this command. Use :INSTrument:SELEct to set the mode.
Dependencies	See Couplings
Couplings	This "PSD" parameter is coupled with the "Meas Type" parameter. The key will be active if the Meas Type is set to PSD. Otherwise, it is grayed out.
Preset	Measured carrier PSD reference power
State Saved	Saved in instrument state.
Min	-200
Max	200
Initial S/W Revision	Prior to A.02.00
Modified at S/W Revision	A.02.00, A.03.00

Spectrum Peak

Sets the spectrum peak power in the carrier that is used to compute the relative power spectral density values for the offsets when Meas Type is set to Spectrum Peak. When the state is set to auto, this will be set to the measured carrier spectrum peak power. When set to manual, the result takes on the last

Spectrum Emission Mask Measurement Meas Setup

measured value, or can be manually entered

Key Path	Meas Setup, Ref Channel, Power Ref
Mode	SA, WCDMA, C2K , WIMAX OFDMA, TD-SCDMA, 1xEVDO, DTMB (CTTB), DVB-T/H, ISDB-T, CMMB, LTE, LTETDD, Digital Cable TV, WLAN
Remote Command	[:SENSE] :SEMAsk :CARRier :PEAK [:POWer] <real> [:SENSE] :SEMAsk :CARRier :PEAK [:POWer] ?
Example	SEM:CARR:PEAK -80 SEM:CARR:PEAK:POWER?
Notes	Although the default value is defined, the value is recalculated by the measurement result just after completing the measurement. Carrier sub op code. 1 for BTS, 2 for MS. Default is BTS. You must be in the mode that includes SEM measurement to use this command. Use :INSTrument:SELect to set the mode.
Dependencies	See Couplings
Couplings	This "Spectrum Peak Ref" parameter is coupled with the "Meas Type" parameter. This softkey would be active if the "Meas Type" is set to "Spectrum Peak Ref". Otherwise, grayout.
Preset	Measured carrier Spectrum Peak reference power
State Saved	Saved in instrument state.
Min	-200
Max	200
Initial S/W Revision	Prior to A.02.00
Modified at S/W Revision	A.02.00, A.03.00

Power Ref (Only for MSR)

Selects the power reference type.

Carrier powers are measured only for carriers specified by Power Ref. When max power carrier is selected, all carriers with Measure Carrier On are measured to determine the max power.

Left & Right Carriers - Powers of leftmost and rightmost carriers with Measure Carrier On are the references of left and right sides respectively. Left and right carriers are determined based on the carrier center frequencies. If Measur Carriers of all the carriers are off, the reference power and all the relative power results are NaN. Relative limits are not evaluated.

Max Power Carrier - Maximum carrier power is the reference of measurement. If Measur Carriers of all the carriers are off, the reference power and all the relative power results are NaN. Relative limits are not evaluated.

Carrier Index - Power of the specified carrier is the reference of measurement. If Measur Carriers of this

carrier index is off, the reference power and all the relative power results are NaN. Relative limits are not evaluated.

Manual - Power or PSD specified by the user is the reference of measurement.

Key Path	Meas Setup, Ref Channel						
Mode	MSR						
Remote Command	[:SENSE] :SEMask :CARRier :PREFereNce :TYPE LRCarriers MPCarrier CINDEX MANual [:SENSE] :SEMask :CARRier :PREFereNce :TYPE?						
Example	SEM:CARR:PREF:TYPE CIND SEM:CARR:PREF:TYPE?						
Notes	This command is available only in MSR. You must be in the MSR mode to use this command. Use :INSTrument:SElect to set the mode.						
Preset	MPCarrier						
State Saved	Saved in instrument state						
Range	Left & Right Carriers Max Power Carriers Carrier Index Manual						
Readback	Indirect readback as below: <table border="1" style="margin-left: auto; margin-right: auto;"> <tr> <td style="text-align: center;">Power Ref [Max Power▶ Carrier]</td> <td style="text-align: center;">Power Ref [Left & Right▶ Carriers]</td> <td style="text-align: center;">Power Ref [Carrier Index▶ 1]</td> </tr> <tr> <td style="text-align: center;">Power Ref [Manual Power,▶ -10 dBm]</td> <td style="text-align: center;">Power Ref [Manual PSD,▶ -10 dBm/Hz]</td> <td style="text-align: center;">Power Ref [Manual Spec Pk,▶ -10 dBm]</td> </tr> </table>	Power Ref [Max Power▶ Carrier]	Power Ref [Left & Right▶ Carriers]	Power Ref [Carrier Index▶ 1]	Power Ref [Manual Power,▶ -10 dBm]	Power Ref [Manual PSD,▶ -10 dBm/Hz]	Power Ref [Manual Spec Pk,▶ -10 dBm]
Power Ref [Max Power▶ Carrier]	Power Ref [Left & Right▶ Carriers]	Power Ref [Carrier Index▶ 1]					
Power Ref [Manual Power,▶ -10 dBm]	Power Ref [Manual PSD,▶ -10 dBm/Hz]	Power Ref [Manual Spec Pk,▶ -10 dBm]					
Initial S/W Revision	A.10.01						

Carrier Index (Only for MSR)

Sets carrier index of the reference power. The power of the carrier selected by this index becomes reference power when Power Ref is Carrier Index.

Key Path	Meas Setup, Ref Channel, Power Ref
Mode	MSR
Remote Command	[:SENSE] :SEMask :CARRier :INDEX <integer> [:SENSE] :SEMask :CARRier :INDEX?
Example	SEM:CARR:IND 1 SEM:CARR:IND?

Spectrum Emission Mask Measurement
Meas Setup

Notes	This command is available only in MSR. You must be in the MSR mode to use this command. Use :INSTrument:SElect to set the mode.
Preset	1
State Saved	Saved in instrument state
Min	1
Max	100
Initial S/W Revision	A.10.01

Manual (Only for MSR)

Accesses a menu that sets the manual reference power that is used to compute the relative values for the offsets.

Key Path	Meas Setup, Power Ref
Initial S/W Revision	A.10.01

Total Power

Sets manual total power reference. This is used when Power Ref is Manual and Meas Type is Total Power.

See [“Total Power” on page 754](#) Total Power Pwr Ref for more information.

Key Path	Meas Setup, Ref Channel, Power Ref, Manual
Initial S/W Revision	A.10.01

PSD

Sets manual PSD reference. This is used when Power Ref is Manual and Meas Type is PSD.

See [“PSD” on page 755](#) PSD for more information.

Key Path	Meas Setup, Ref Channel, Power Ref, Manual
Initial S/W Revision	A.10.01

Spectrum Peak

Sets manual Spectrum Peak reference. This is used when Power Ref is Manual and Meas Type is Spectrum Peak.

See [“Spectrum Peak” on page 755](#) Spectrum Peak for more information.

Key Path	Meas Setup, Ref Channel, Power Ref, Manual
Initial S/W Revision	A.10.01

Offsets/Limit

Accesses a menu that enables you to set up the measurement parameters for the offset pairs. For example, you can assign the start and stop frequencies, select the resolution bandwidth, and set the sweep time.

Key Path	Meas Setup
Initial S/W Revision	Prior to A.02.00

Select Offset

Selects the offset pairs (upper and lower) that affect the menu keys, and displays the memory selection menu from A to F (A to L for MSR). The memory selection menu allows you to store up to 5 (or 12 for MSR) sets of parameter values for the offset pairs, such as Start Freq, Stop Freq, Sweep Time, Res BW, Meas BW, Abs Start, and Abs Stop. Only one selection at a time is shown on this menu key label.

Key Path	Meas Setup, Offsets/Limit
Mode	SA, WCDMA, C2K, WIMAX OFDMA, TD-SCDMA, 1xEVDO, DTMB (CTTB), DVB-T/H, ISDB-T, CMMB, LTE, LTETDD, Digital Cable TV, WLAN, MSR
Preset	A
Range	MSR: A B C D E F G H I J K L Other modes: A B C D E F
Initial S/W Revision	Prior to A.02.00
Modified at S/W Revision	A.02.00, A.03.00, A.10.01

Start Freq

Specifies the start frequency for the currently selected offset and enables you to toggle this function On or Off for each offset.

Key Path	Meas Setup, Offset/Limit
Mode	SA, WCDMA, C2K, WIMAX OFDMA, TD-SCDMA, 1xEVDO, DTMB (CTTB), DVB-T/H, ISDB-T, CMMB, LTE, LTETDD, Digital Cable TV, WLAN, MSR
Remote Command	[:SENSE] :SEMAsk :OFFSet [1] 2 :LIST :FREQuency :STARt <freq> , ... [:SENSE] :SEMAsk :OFFSet [1] 2 :LIST :FREQuency :STARt ? [:SENSE] :SEMAsk :OFFSet [1] 2 :LIST :STATe ON OFF 1 0 , ... [:SENSE] :SEMAsk :OFFSet [1] 2 :LIST :STATe ?

Spectrum Emission Mask Measurement
Meas Setup

Example	<p>SEM:OFFS2:LIST:FREQ:STAR 2.515 MHz, 2.715 MHz, 3.515 MHz, 4.00 MHz, 8.00 MHz, 12.50 MHz</p> <p>SEM:OFFS2:LIST:FREQ:STAR?</p> <p>SEM:OFFS:LIST:STAT ON, ON, ON, OFF, OFF, OFF</p> <p>SEM:OFFS:LIST:STAT?</p>
Notes	<p>Comma separated list of 12 values for MSR and 6 values for other modes. OFFSet1 is for BTS, 2 for MS. Default is BTS.</p> <p>You must be in the mode that includes SEM measurement to use this command. Use :INSTrument:SELEct to set the mode.</p>
Couplings	<p>Coupled to Stop Freq. Start cannot go above the stop freq less 100Hz. Similarly Stop freq cannot go below Start Freq plus 100Hz.</p> <p>If the current mode is DVB-T/H, this value will be modified automatically according to the limit type and the output power of the transmitter which is less or more than 25W.</p> <p>If the current mode is ISDB-T, this value will be modified automatically according to the limit type.</p>

Preset	<p>SA: 2.515 MHz, 2.715 MHz, 3.515 MHz, 4.00 MHz, 8.00 MHz, 12.50 MHz</p> <p>WCDMA: 2.515 MHz, 2.715 MHz, 3.515 MHz, 4.000 MHz, 8.000 MHz, 12.50 MHz 2.515MHz, 4.000 MHz, 7.500 MHz, 8.500 MHz, 12.5 MHz, 15 MHz</p> <p>C2K: 750.0 kHz, 780.0 kHz, 1.980 MHz, 3.25 MHz, 7.0 MHz, 7.0 MHz 885 kHz, 1.980 MHz, 2.250 MHz, 8.0 MHz, 12.0 MHz, 12.0 MHz</p> <p>WIMAX OFDMA: 4.75 MHz,5.45 MHz,9.75 MHz,14.75 MHz,19.75 MHz,24.75 MHz 4.75 MHz,5.45 MHz,9.75 MHz,14.75 MHz,19.75 MHz,24.75 MHz</p> <p>TD-SCDMA:</p> <p>81 5kHz,1015 kHz,1815 kHz,2.3 MHz, ,2.3 MHz,,2.3 MHz 815 kHz,1.8 MHz,2.9 MHz, 2.9 MHz,2.9 MHz, 2.9 MHz</p> <p>1xEVDO: 750.0 kHz, 780.0 kHz, 1.98 MHz, 3.25 MHz, 7 MHz, 7 MHz 885.0 kHz, 1.98 MHz, 1.98 MHz , 1.98 MHz, 1.98 MHz, 1.98 MHz</p> <p>DTMB (CTTB): 3.8 MHz, 4.2 MHz, 6 MHz, 12 MHz, 12 MHz, 12 MHz</p> <p>DVB-T/H: 3.81 MHz, 4.2 MHz, 6 MHz, 12 MHz, 12 MHz, 12 MHz</p> <p>ISDB-T: 2.79 MHz, 2.86 MHz, 3.0 MHz, 4.36 MHz, 15.0 MHz, 15.0 MHz</p> <p>CMMB: 3.8 MHz, 4.2 MHz, 8.0 MHz, 12.0 MHz,12.0 MHz, 12.0 MHz</p> <p>LTE, LTETDD: 50 kHz, 5.05 MHz, 10.5 MHz, 15.00 MHz, 30 MHz, 40 MHz 15.00 kHz,1.5 MHz,5.5 MHz,6.5 MHz,10 MHz,20MHz</p> <p>Digital Cable TV: 3.8 MHz, 4.2 MHz, 6 MHz, 12 MHz, 12 MHz, 12 MHz</p> <p>WLAN:</p> <p>if Radio Std is 802.11a/g(OFDM/DSSS-OFDM)/802.11n(20MHz): 9 MHz, 11 MHz, 20 MHz, 30 MHz, 50 MHz, 216 MHz</p> <p>if Radio Std is 802.11b/g(DSSS/CCK/PBCC): 11 MHz, 22 MHz, 50 MHz, 70 MHz, 90 MHz, 100 MHz</p> <p>if Radio Std is 802.11n(20MHz): 9 MHz, 11 MHz, 20 MHz, 30 MHz, 50 MHz, 100 MHz</p> <p>if Radio Std is 802.11n(40MHz): 19 MHz, 21 MHz, 40 MHz, 60 MHz, 100 MHz, 200 MHz</p> <p>MSR:15 kHz, 215kHz, 1.015MHz, 1.5MHz, 10.5MHz, 15.00MHz, 30MHz, 30MHz, 30MHz, 30MHz, 30MHz 15kHz, 215kHz, 1.015MHz, 1.5MHz, 10.5MHz, 15.00MHz, 30MHz, 30MHz, 30MHz, 30MHz, 30MHz</p> <p>SA: ON, ON, ON, ON, ON, OFF</p> <p>WCDMA: ON, ON, ON, ON, ON, OFF ON, ON, ON, ON, OFF, OFF</p> <p>C2K: ON, ON, ON, OFF, OFF, OFF ON, ON, OFF, OFF, OFF, OFF</p> <p>WIMAX OFDMA: ON, ON, ON, OFF, OFF, OFF ON, ON, ON, OFF, OFF, OFF</p> <p>TD-SCDMA: ON, ON, ON, ON, OFF, OFF ON, ON, ON, OFF, OFF, OFF</p> <p>1xEVDO: ON, ON, ON, OFF, OFF, OFF ON, ON, OFF, OFF, OFF, OFF</p> <p>DTMB (CTTB): ON, ON, ON, OFF, OFF, OFF</p>
	<p>DVB-T/H: ON, ON, ON, OFF, OFF, OFF</p> <p>ISDB-T: ON, ON, ON, ON, OFF, OFF</p> <p>CMMB: ON, ON, ON, OFF, OFF, OFF</p>

Spectrum Emission Mask Measurement
Meas Setup

State Saved	Saved in instrument state.
Min	0 Hz
Max	Stop Freq minus (-) 100 Hz (for that offset)
Initial S/W Revision	Prior to A.02.00
Modified at S/W Revision	A.02.00, A.03.00, A.10.01

Stop Freq

Specifies the stop frequency for the currently selected offset.

Key Path	Meas Setup, Offset/Limit
Mode	SA, WCDMA, C2K, WIMAX OFDMA, TD-SCDMA, 1xEVDO, DTMB (CTTB), DVB-T/H, ISDB-T, CMMB, LTE, LTETDD, Digital Cable TV, WLAN, MSR
Remote Command	[:SENSe] :SEMAsk:OFFSet [1] 2 :LIST:FREQuency:STOP <freq> , ... [:SENSe] :SEMAsk:OFFSet [1] 2 :LIST:FREQuency:STOP?
Example	SEM:OFFS:LIST:FREQ:STOP 2.715 MHz, 3.515 MHz, 4.00 MHz, 8.00 MHz, 12.50 MHz, 15.0 MHz SEM:OFFS:LIST:FREQ:STOP?
Notes	Comma separated list of 12 values for MSR and 6 values for other modes. OFFSet1 is for BTS, 2 for MS. Default is BTS. You must be in the mode that includes SEM measurement to use this command. Use :INSTrument:SELect to set the mode.
Couplings	Coupled to Start Freq. Start cannot go above the stop freq less 100Hz. Similarly Stop freq cannot go below Start Freq plus 100Hz. If the current mode is DVB-T/H, this value will be modified automatically according to the limit type and the output power of the transmitter which is less or more than 25W. If the current mode is ISDB-T, this value will be modified automatically according to the limit type.

Preset	<p>SA: 2.715 MHz, 3.515 MHz, 4.00 MHz, 8.00 MHz, 12.50 MHz, 15.0 MHz</p> <p>WCDMA: 2.715 MHz, 3.515 MHz, 4.000 MHz, 8.000 MHz, 12.50 MHz, 15.0 MHz, 3.485 MHz, 7.500 MHz, 8.500 MHz, 12.00 MHz, 15.00 MHz, 18.0 MHz</p> <p>C2K: 780.0 kHz, 1.980 MHz, 4.0 MHz, 4.0 MHz, 12.0 MHz, 12.0 MHz, 1.980 MHz, 4.0 MHz, 4.0 MHz, 11.5 MHz, 14.5 MHz, 14.5 MHz</p> <p>WIMAX OFDMA: 5.45 MHz, 9.75 MHz, 14.75 MHz, 19.75 MHz, 24.75 MHz, 29.75 MHz, 5.45 MHz, 9.75 MHz, 14.75 MHz, 19.75 MHz, 24.75 MHz, 29.75 MHz</p> <p>TD-SCDMA:</p> <p>1015 kHz, 1815 kHz, 2.3 MHz, 4 MHz, 4 MHz, 4 MHz, 1.8 MHz, 2385 kHz, 3.5 MHz, 3.5 MHz, 3.5 MHz, 3.5 MHz</p> <p>1xEVDO: 780.0 kHz, 1.98 MHz, 4.0 MHz, 4.0 MHz, 12 MHz, 12 MHz, 1.98 MHz, 4.0 MHz, 4.0 MHz, 4.0 MHz, 4.0 MHz, 4.0 MHz</p> <p>DTMB (CTTB): 4.2 MHz, 6 MHz, 12 MHz, 12 MHz, 12 MHz, 12 MHz</p> <p>DVB-T/H: 4.2 MHz, 6 MHz, 12 MHz, 12 MHz, 12 MHz, 12 MHz</p> <p>ISDB-T: 2.86 MHz, 3.0 MHz, 4.36 MHz, 15.0 MHz, 15.0 MHz, 15.0 MHz</p> <p>CMMB: 4.2 MHz, 8.0 MHz, 12.0 MHz, 12.0 MHz, 12.0 MHz, 12.0 MHz</p> <p>LTE, LTE-TDD: 5.05 MHz, 10.05 MHz, 15 MHz, 30 MHz, 40 MHz, 50 MHz, 985.0 kHz, 4.50 MHz, 5.5001 MHz, 9.50 MHz, 20 MHz, 40 MHz</p> <p>Digital Cable TV: 4.2 MHz, 6.0 MHz, 12.0 MHz, 12.0 MHz, 12.0 MHz, 12.0 MHz</p> <p>WLAN:</p> <p>if Radio Std is 802.11a/g(OFDM/DSSS-OFDM)/802.11n(20MHz): 11 MHz, 20 MHz, 30 MHz, 50 MHz, 100 MHz, 250 MHz</p> <p>if Radio Std is 802.11b/g(DSSS/CCK/PBCC): 22 MHz, 50 MHz, 70 MHz, 90 MHz, 100 MHz, 120 MHz</p> <p>if Radio Std is 802.11n(20MHz): 11 MHz, 20 MHz, 30 MHz, 50 MHz, 100 MHz, 200 MHz</p> <p>if Radio Std is 802.11n(40MHz): 21 MHz, 40 MHz, 60 MHz, 100 MHz, 200 MHz, 300 MHz</p> <p>MSR: 215 kHz, 1.015 MHz, 1.5 MHz, 10.5 MHz, 50 MHz, 50 MHz, 50 MHz, 50 MHz, 50 MHz, 50 MHz, 50 MHz</p>
State Saved	Saved in instrument state.
Min	Start Freq plus (+) 100 Hz (for that offset)
Max	500 MHz
Initial S/W Revision	Prior to A.02.00
Modified at S/W Revision	A.02.00, A.03.00, A.10.01

Sweep Time

Specifies the sweep time for the currently selected offset and enables you to toggle this function On or Off for each offset.

Key Path	Meas Setup, Offset/Limit
Mode	SA, WCDMA, C2K, WIMAX OFDMA, TD-SCDMA, 1xEVDO, DTMB (CTTB), DVB-T/H, ISDB-T, CMMB, LTE, LTETDD, Digital Cable TV, WLAN, MSR
Remote Command	<pre>[:SENSE]:SEMask:OFFSet[1] 2:LIST:SWEep:TIME <time>, ... [:SENSE]:SEMask:OFFSet[1] 2:LIST:SWEep:TIME? [:SENSE]:SEMask:OFFSet[1] 2:LIST:SWEep:TIME:AUTO ON OFF 1 0, ... [:SENSE]:SEMask:OFFSet[1] 2:LIST:SWEep:TIME:AUTO?</pre>
Example	<pre>SEM:OFFS2:LIST:SWE:TIME 1.0 ms, 3.4 ms, 2.08 ms, 1.0 ms, 1.0 ms, 1.0 ms SEM:OFFS2:LIST:SWE:TIME? SEM:OFFS2:LIST:SWE:TIME:AUTO ON, ON, ON, ON, OFF, OFF SEM:OFFS2:LIST:SWE:TIME:AUTO?</pre>
Notes	<p>Comma separated list of 12 values for MSR and 6 values for other modes. OFFSet1 is for BTS, 2 for MS. Default is BTS.</p> <p>You must be in the mode that includes SEM measurement to use this command. Use :INSTrument:SElect to set the mode.</p>
Couplings	<p>When the sweep time is set manually, Mode coupling is set to MANual</p> <p>If the current mode is DVB-T/H, this value will be modified automatically according to the output power of the transmitter which is less or more than 25W.</p> <p>If the current mode is ISDB-T, this value will be modified automatically according to the limit type.</p>
Preset	<p>Automatically calculated</p> <p>MSR: ON,ON,ON,ON,ON,ON,ON,ON,ON,ON,ON,ON,ON</p> <p>Other modes: ON,ON,ON,ON,ON,ON</p>
State Saved	Saved in instrument state.
Min	1 ms
Max	10 s
Backwards Compatibility SCPI	[:SENSE]:SEMask:OFFSet[1] 2:LIST:SWEep[:TIME]
Initial S/W Revision	Prior to A.02.00
Modified at S/W Revision	A.02.00, A.03.00, A.10.01

Offset Side

Specifies which offset side to measure.

You can turn off (not use) specific offsets with [:SENSE]:SEMask:OFFSet[n]:LIST:STATe.

BOTH - both of the negative (lower) and positive (upper) sidebands

NEGative - negative (lower) sideband only

POSitive - positive (upper) sideband only

Key Path	Meas Setup, Offset/Limit
Mode	SA, WCDMA, C2K, WIMAX OFDMA, TD-SCDMA, 1xEVDO, DTMB (CTTB), DVB-T/H, ISDB-T, CMMB, LTE, LTETDD, Digital Cable TV, WLAN, MSR
Remote Command	[:SENSE] :SEMask :OFFSet [1] 2 :LIST :SIDE BOTH NEGative POSitive, ... [:SENSE] :SEMask :OFFSet [1] 2 :LIST :SIDE?
Example	SEM:OFFS:LIST:SIDE BOTH, NEG, NEG, POS, POS, POS SEM:OFFS:LIST:SIDE?
Notes	Comma separated list of 12 values for MSR and 6 values for other modes. OFFSet1 is for BTS, 2 for MS. Default is BTS. You must be in the mode that includes SEM measurement to use this command. Use :INSTrument:SElect to set the mode.
Preset	MSR: BOTH, BOTH, BOTH, BOTH, BOTH, BOTH, BOTH, BOTH, BOTH, BOTH, BOTH, BOTH Other modes: BOTH, BOTH, BOTH, BOTH, BOTH, BOTH
State Saved	Saved in instrument state.
Range	Neg Both Pos
Initial S/W Revision	Prior to A.02.00
Modified at S/W Revision	A.02.00, A.03.00, A.10.01

Res BW

Specifies which Resolution BW filter to use when measuring the currently selected offset.

Offset Res BW Mode allows the instrument to determine the optimum Resolution BW filter to use when measuring the currently selected offset.. When changing the Meas BW parameter, if the Res BW needs to be changed to adhere to the rule

$$(N \times \text{Res BW}) \leq (\text{Stop freq of the offset} - \text{Start freq of the offset}),$$

where N is the multiplier, this setting will automatically be changed to manual.

Key Path	Meas Setup, Offset/Limit

Spectrum Emission Mask Measurement
Meas Setup

Mode	SA, WCDMA, C2K, WIMAX OFDMA, TD-SCDMA, 1xEVDO modeDTMB (CTTB), DVB-T/H, ISDB-T, CMMB, LTE, LTETDD, Digital Cable TV, WLAN, MSR
Remote Command	<pre>[:SENSe]:SEMAsk:OFFSet[1] 2:LIST:BANDwidth[:RESolution] <bandwidth>, ... [:SENSe]:SEMAsk:OFFSet[1] 2:LIST:BANDwidth[:RESolution] ? [:SENSe]:SEMAsk:OFFSet[1] 2:LIST:BANDwidth[:RESolution] :AUTO OFF ON 1 0, ... [:SENSe]:SEMAsk:OFFSet[1] 2:LIST:BANDwidth[:RESolution] :AUTO?</pre>
Example	<pre>SEM:OFFS2:LIST:BAND 30.0 kHz, 30.0 kHz, 30.0 kHz, 1.00 MHz,1.00 MHz, 1.00 MHz SEM:OFFS2:LIST:BAND? SEM:OFFS:LIST:BAND:AUTO 1,1,1,1,1,1 SEM:OFFS:LIST:BAND:AUTO?</pre>
Notes	<p>Comma separated list of 12 values for MSR and 6 values for other modes. OFFSet1 is for BTS, 2 for MS. Default is BTS.</p> <p>You must be in the mode that includes SEM measurement to use this command. Use :INSTrument:SELEct to set the mode.</p>
Couplings	<p>Coupled to Start and Stop offset and Meas BW multiplier. This parameter must adhere to the rule $(N \times \text{Res BW}) \leq (\text{Stop freq of the offset} - \text{Start freq of the offset})$, where N is the multiplier. If the multiplier is changed, the Res BW will be changed to ensure this. When set manually, Res BW Coupling is set to manual.</p>

Preset	<p>SA: 30.0 kHz, 30.0 kHz, 30.0 kHz, 1.00 MHz,1.00 MHz, 1.00 MHz</p> <p>WCDMA: 30.00 kHz, 30.00 kHz, 30.00 kHz, 100.00 kHz, 1.000 MHz, 1.00 MHz 30.00 kHz, 1.000 MHz, 1.000 MHz, 1.000 MHz, 1.000 MHz, 1.00 MHz</p> <p>C2K: 3.00 kHz, 30.00 kHz, 30.00 kHz, 6.2 kHz, 1.000 MHz, 1.00 MHz 30.00 kHz, 30.00 kHz, 6.2 kHz, 1.000 MHz, 1.000 MHz, 1.00 MHz</p> <p>WIMAX OFDMA: 100 KHz, 100 KHz, 100 KHz, 100 KHz, 100 KHz, 100 KHz 100 KHz, 100 KHz, 100 KHz, 100 KHz, 100 KHz, 100 KHz</p> <p>TD-SCDMA: 30 kHz, 30 kHz, 30 kHz, 50 kHz, 1 MHz, 1 MHz 30 kHz, 30 kHz, 50 kHz, 1 MHz, 1 MHz, 1 MHz</p> <p>1xEVDO: 30.00 kHz, 30.00 kHz, 30.00 kHz, 6.2 kHz, 1.000 MHz, 1.000 MHz 30.00 kHz, 30.00 kHz, 30.00 kHz, 30.00 kHz, 30.00 kHz, 30.00 kHz</p> <p>DTMB (CTTB): 3.9 kHz, 3.9 kHz, 3.9 kHz, 3.9 kHz, 3.9 kHz, 3.9 kHz</p> <p>DVB-T/H: 3.9 kHz, 3.9 kHz, 3.9 kHz, 3.9 kHz, 3.9 kHz, 3.9 kHz</p> <p>ISDB-T: 10.0 kHz, 10.0 kHz, 10.0 kHz, 10.0 kHz, 10. kHz, 10.0 kHz</p> <p>CMMB: 3.9 kHz, 3.9 kHz, 3.9 kHz, 3.9 kHz, 3.9 kHz, 3.9 kHz</p> <p>LTE, LTETDD: 51 kHz, 100 kHz, 1.0 MHz, 1.0 MHz,1.0 MHz, 1.0 MHz 15.0 kHz, 510 kHz,1.0 MHz,1.0 MHz,1.0 MHz,1.0 MHz</p> <p>Digital Cable TV: 3.9 kHz, 3.9 kHz, 3.9 kHz, 3.9 kHz, 3.9 kHz, 3.9 kHz</p> <p>WLAN: 100 KHz, 100 KHz, 100 KHz, 100 KHz, 100 KHz, 100 KHz</p> <p>MSR: 30kHz, 30kHz, 30kHz, 1.0MHz,1.0MHz, 1.0MHz, 1.0MHz, 1.0MHz, 1.0MHz, 1.0MHz, 1.0MHz 30kHz, 30kHz, 30kHz, 1.0MHz,1.0MHz, 1.0MHz, 1.0MHz, 1.0MHz, 1.0MHz, 1.0MHz, 1.0MHz</p> <p>MSR: OFF, OFF, OFF, OFF, OFF, OFF, OFF, OFF, OFF, OFF, OFF, OFF OFF, OFF, OFF, OFF, OFF, OFF, OFF, OFF, OFF, OFF, OFF, OFF</p> <p>Other modes: OFF, OFF, OFF, OFF, OFF, OFF OFF, OFF, OFF, OFF, OFF, OFF</p>
State Saved	Saved in instrument state.
Min	1 Hz
Max	8 MHz
Backwards Compatibility SCPI	[[:SENSe]:SEMAsk:OFFSet[1]]2:LIST:BWIDth[:RESolution]
Initial S/W Revision	Prior to A.02.00
Modified at S/W Revision	A.02.00, A.03.00, A.10.01

Meas BW

Allows you to specify a multiplier of Res BW for the measurement integration bandwidth.

Meas BW is multiplier integer number. It shows a ratio between Integration BW and Resolution BW of the measurement result.

$$\text{Integ BW} = \text{Meas BW} * \text{Resolution BW}$$

Spectrum Emission Mask Measurement
Meas Setup

Integration BW is desired resolution bandwidth and Resolution BW is actual bandwidth for sweep. Measurement sweeps with Resolution BW and Meas BW compensates sweep resolution bandwidth to Integration BW.

If you set this parameter greater than 1, you can set Resolution BW narrower to avoid carrier power leakage effect to the offset power integration.

Key Path	Meas Setup, Offset/Limit
Mode	SA, WCDMA, C2K, WIMAX OFDMA, TD-SCDMA, 1xEVDO, DTMB (CTTB), DVB-T/HISDB-T, CMMB, LTE, LTETDD, Digital Cable TV, WLAN
Remote Command	[:SENSe] :SEMAsk:OFFSet[1] 2 :LIST:BAWdwidth:IMULti <integer>, ... [:SENSe] :SEMAsk:OFFSet[1] 2 :LIST:BAWdwidth:IMULti?
Example	SEM:OFFS2:LIST:BAND:IMUL 1,1,1,1,1,1 SEM:OFFS2:LIST:BAND:IMUL?
Notes	Comma separated list of 12 values for MSR and 6 values for other modes. OFFSet1 is for BTS, 2 for MS. Default is BTS. You must be in the mode that includes SEM measurement to use this command. Use :INSTrument:SELEct to set the mode.
Couplings	This parameter must adhere to the rule (N x Res BW) <= (Stop freq of the offset - Start freq of the offset), where N is the multiplier. If the Res Bw is changed, the multiplier will be changed to ensure this.
Preset	SA: 1, 1, 1, 1, 1, 1 WCDMA: 1, 1, 1, 10, 1, 1 1, 1, 1, 1, 1, 1 C2K: 10, 1, 1, 1, 1, 1 1, 1, 1, 1, 1, 1 WIMAX OFDMA: 1, 1, 1, 1, 1, 1 1, 1, 1, 1, 1, 1 TD-SCDMA:1, 1, 1, 20, 1, 1 1, 1, 20, 1, 1, 1 1xEVDO: 1, 1, 1, 1, 1 1, 1, 1, 1, 1, 1 DTMB (CTTB): 1, 1, 1, 1, 1, 1 DVB-T/H: 1, 1, 1, 1, 1, 1 ISDB-T: 1, 1, 1, 1, 1, 1 CMMB: 1, 1, 1, 1, 1, 1 LTE: 2, 1, 1, 1, 1, 1 2, 2, 1, 1, 1, 1 LTETDD: 2, 1, 1, 1, 1, 1 2, 2, 1, 1, 1, 1 Digital Cable TV : 1, 1, 1, 1, 1, 1 WLAN: 1, 1, 1, 1, 1, 1 MSR: 1, 1, 1, 1, 1, 1, 1, 1, 1, 1, 1, 1 1, 1, 1, 1, 1, 1, 1, 1, 1, 1, 1, 1
State Saved	Saved in instrument state.

Min	1
Max	1000
Backwards Compatibility SCPI	[:SENSE]:SEMAsk:OFFSet[1] 2:LIST:BWIDth:IMULti
Initial S/W Revision	Prior to A.02.00
Modified at S/W Revision	A.02.00, A.03.00, A.10.01

Video BW

Changes the analyzer post-detection filter.

Key Path	Meas Setup, Offset/Limit
Mode	SA, WCDMA, C2K, WIMAXOFDMA, TD-SCDMA, 1xEVDO, DTMB (CTTB), DVB-T/HISDB-T, CMMB, LTE, LTETDD, Digital Cable TV, WLAN, MSR
Remote Command	[:SENSE]:SEMAsk:OFFSet[1] 2:LIST:BANDwidth:VIDeo <freq>, ... [:SENSE]:SEMAsk:OFFSet[1] 2:LIST:BANDwidth:VIDeo? [:SENSE]:SEMAsk:OFFSet[1] 2:LIST:BANDwidth:VIDeo:AUTO OFF ON 0 1, ... [:SENSE]:SEMAsk:OFFSet[1] 2:LIST:BANDwidth:VIDeo:AUTO?
Example	SEM:OFFS2:LIST:BAND:VID 3.00 kHz, 3.00 kHz, 3.00 kHz, 100.0 kHz, 100.0 kHz, 100.0 kHz SEM:OFFS2:LIST:BAND:VID? SEM:OFFS2:LIST:BAND:VID:AUTO ON, ON, ON, ON, ON, ON SEM:OFFS2:LIST:BAND:VID:AUTO?
Notes	Comma separated list of 12 values for MSR and 6 values for other modes. OFFSet1 is for BTS, 2 for MS. Default is BTS. You must be in the mode that includes SEM measurement to use this command. Use :INSTrument:SElect to set the mode.
Preset	ISDB-T: 1.0kHz, 1.0kHz, 1.0kHz, 1.0kHz, 1.0kHz, 1.0kHz Other than ISDB-T: Automatically Calculated MSR: ON, ON, ON, ON, ON, ON, ON, ON, ON, ON, ON, ON, ON ON, ON, ON, ON, ON, ON, ON, ON, ON, ON, ON, ON ISDB-T: OFF, OFF, OFF, OFF, OFF, OFF OFF, OFF, OFF, OFF, OFF, OFF Other modes: ON, ON, ON, ON, ON, ON, ON ON, ON, ON, ON, ON, ON
State Saved	Saved in instrument state.
Min	1 Hz
Max	50 MHz

Spectrum Emission Mask Measurement
Meas Setup

Backwards Compatibility SCPI	[:SENSe] :SEMAsk :OFFSet [1] 2 :LIST :BWIDth :VIDeo
Initial S/W Revision	Prior to A.02.00
Modified at S/W Revision	A.02.00, A.03.00, A.10.01

VBW/RBW

Selects the ratio between the video and resolution bandwidths.

Key Path	Meas Setup, Offset/Limit
Mode	SA, WCDMA, C2K, WIMAX OFDMA, TD-SCDMA, 1xEVDO, DTMB (CTTB), DVB-T/H, ISDB-T, CMMB, LTE, LTETDD, Digital Cable TV, WLAN, MSR
Remote Command	[:SENSe] :SEMAsk :OFFSet [1] 2 :LIST :BANDwidth :VIDeo :RATio <real>, ... [:SENSe] :SEMAsk :OFFSet [1] 2 :LIST :BANDwidth :VIDeo :RATio? [:SENSe] :SEMAsk :OFFSet [1] 2 :LIST :BANDwidth :VIDeo :RATio : AUTO OFF ON 0 1, ... [:SENSe] :SEMAsk :OFFSet [1] 2 :LIST :BANDwidth :VIDeo :RATio : AUTO?
Example	SEM:OFFS2:LIST:BAND:VID:RAT 0.1, 0.1, 0.1, 0.1, 0.1, 0.1 SEM:OFFS2:LIST:BAND:VID:RAT? SEM:OFFS2:LIST:BAND:VID:RAT:AUTO ON, ON, ON, ON, ON, ON SEM:OFFS2:LIST:BAND:VID:RAT:AUTO?
Notes	Comma separated list of 12 values for MSR and 6 values for other modes. OFFSet1 is for BTS, 2 for MS. Default is BTS. You must be in the mode that includes SEM measurement to use this command. Use :INSTrument:SELEct to set the mode.

Preset	SA, WCDMA, C2K, LTE, LTETDD: 0.01, 0.01, 0.01, 0.01, 0.01, 0.01 0.01, 0.01, 0.01, 0.01, 0.01 WIMAX OFDMA: 0.3, 0.3, 0.3, 0.3, 0.3, 0.3 TD-SCDMA: 10, 10, 10, 10, 1, 1 10, 10, 10, 1, 1, 1 1xEVDO: 10, 10, 10, 10, 10, 10 10, 10, 10, 10, 10, 10 DTMB (CTTB): 10, 10, 10, 10, 10, 10 DVB-T/H: 10, 10, 10, 10, 10, 10 ISDB-T: 0.1, 0.1, 0.1, 0.1, 0.1, 0.1 CMMB: 10, 10, 10, 10, 10, 10 Digital Cable TV : 10, 10, 10, 10, 10, 10 WLAN: 0.3, 0.3, 0.3, 0.3, 0.3, 0.3 MSR: 0.01, 0.01, 0.01, 0.01, 0.01, 0.01, 0.01, 0.01, 0.01, 0.01, 0.01, 0.01 0.01, 0.01, 0.01, 0.01, 0.01, 0.01, 0.01, 0.01, 0.01, 0.01, 0.01 MSR: OFF, OFF, OFF, OFF, OFF, OFF, OFF, OFF, OFF, OFF, OFF, OFF OFF, OFF, OFF, OFF, OFF, OFF, OFF, OFF, OFF, OFF, OFF Other modes: OFF, OFF, OFF, OFF, OFF, OFF OFF, OFF, OFF, OFF, OFF, OFF
State Saved	Saved in instrument state.
Min	0.00001
Max	3000000
Initial S/W Revision	Prior to A.02.00
Modified at S/W Revision	A.02.00, A.03.00, A.10.01

Limits

Accesses a menu that enables you to set the power limits for start and stop frequencies of the selected offsets.

Key Path	Meas Setup
Initial S/W Revision	Prior to A.02.00

Abs Start

Sets the absolute power level limit at the start frequency for the selected offset. The absolute power level limit ranges from -200 to +50 dBm.

The fail condition for each offset channel is set remotely by [:SENSe]:SEMAsk:OFFSet[n]:LIST:TEST.

You can turn off (not use) specific offset channels remotely with [:SENSe]:SEMAsk:OFFSet[n]:LIST:STAtE.

Spectrum Emission Mask Measurement
Meas Setup

The SCPI query returns the five (5) sets of real values currently set to the absolute power test limits.

Key Path	Meas Setup, Offset/Limit, Limits
Mode	SA, WCDMA, C2K, WIMAX OFDMA, TD-SCDMA, 1xEVDO, DTMB (CTTB), DVB-T/H, ISDB-T, CMMB, LTE, LTETDD, Digital Cable TV, WLAN, MSR
Remote Command	[:SENSE] :SEMAsk:OFFSet[1] 2:LIST:STARt:ABSolute <real> , ... [:SENSE] :SEMAsk:OFFSet[1] 2:LIST:STARt:ABSolute?
Example	SEM:OFFS2:LIST:STAR:ABS -12.50 dBm, -12.50 dBm, -24.50 dBm, -11.50 dBm, -11.50 dBm, -11.50 dBm SEM:OFFS2:LIST:STAR:ABS?
Notes	Comma separated list of 12 values for MSR and 6 values for other modes. OFFSet1 is for BTS, 2 for MS. Default is BTS. You must be in the mode that includes SEM measurement to use this command. Use :INSTrument:SELect to set the mode.
Couplings	Coupled to Abs Stop if coupling set to “Couple”, that is, the Start value is equal to the Stop value. If the current mode is DVB-T/H, this value will be modified automatically according to the limit type and the output power of the transmitter which is less or more than 25W. If the current mode is ISDB-T, this value will be modified automatically according to the limit type.

Preset	<p>SA, WIMAX OFDMA: -14.00 dBm , -14.00 dBm , -26.00 dBm , -13.00 dBm , -13.00 dBm, -13.00 dBm</p> <p>WCDMA: -12.50 dBm, -12.50 dBm, -24.50 dBm, -11.50 dBm, -11.50 dBm, -11.50 dBm -69.6 dBm, -54.3 dBm, -54.3 dBm, -54.3 dBm, -54.3 dBm, -54.3 dBm</p> <p>C2K: -27.00 dBm, -27.00 dBm, -27.00 dBm, -46.00 dBm, -13.00 dBm, -13.00 dBm -70.13 dBm, -70.13 dBm, -35.00 dBm, -13.00 dBm, -13.00 dBm, -13.00 dBm</p> <p>TD-SCDMA: -28 dBm, -28 dBm, -36 dBm, -21 dBm, -21 dBm, -21 dBm -71.3 dBm, -71.3 dBm, -56.07 dBm, -56.07 dBm, -56.07 dBm, -56.07 dBm</p> <p>1xEVDO: -27.0dBm, -27.00 dBm, -27.00 dBm, -46.00 dBm, -13.00 dBm, -13.00 dBm -70.13 dBm, -70.13 dBm, -70.13 dBm, -70.13 dBm, -70.13 dBm, -70.13 dBm, -70.13 dBm</p> <p>DTMB (CTTB): -14.0 dBm, -14.0 dBm, -26.0 dBm, -13.0 dBm, -13.0 dBm, -13.0 dBm</p> <p>DVB-T/H: 11.2 dBm, -29 dBm, -41 dBm, -66 dBm, -82 dBm, -82 dBm</p> <p>ISDB-T: 50.0 dBm, 50.0 dBm, 50.0 dBm, 50.0 dBm, 50.0 dBm, 50.0 dBm</p> <p>CMMB: 50.0 dBm, 50.0 dBm, 50.0 dBm, 50.0 dBm, 50.0 dBm, 50.0 dBm</p> <p>LTE, LTETDD: -5.5 dBm, -12.5 dBm, -15.0 dBm, -15.0 dBm, -15.0 dBm, -15.0 dBm -13.5 dBm, -8.5 dBm, -11.5 dBm, -23.5 dBm, -23.5 dBm, -23.5 dBm</p> <p>Digital Cable TV: 50.0 dBm, 50.0 dBm, 50.0 dBm, 50.0 dBm, 50.0 dBm, 50.0 dBm</p> <p>WLAN:</p> <p style="padding-left: 20px;">if Radio Std is 802.11a/g(OFDM/DSSS-OFDM): 16.00 dBm, -4.00 dBm, -12.00 dBm, -24.00 dBm, -24.00 dBm, -24.00 dBm</p> <p style="padding-left: 20px;">if Radio Std is 802.11b/g(DSSS/CCK/PBCC): -10 dBm, -30 dBm, -30 dBm, -30 dBm, -30 dBm, -30 dBm</p> <p style="padding-left: 20px;">if Radio Std is 802.11n(20 MHz): 16.00 dBm, -4.00 dBm, -12.00 dBm, -63.00 dBm, -63.00 dBm, -63.00 dBm</p> <p style="padding-left: 20px;">if Radio Std is 802.11n(40 MHz): 16.00 dBm, -4.00 dBm, -12.00 dBm, -66.00 dBm, -66.00 dBm, -66.00 dBm</p> <p>MSR: -12.5 dBm, -12.5 dBm, -24.5 dBm, -11.5 dBm, -15.0 dBm, -15.0 dBm, -15.0 dBm, -15.0 dBm, -15.0 dBm, -15.0 dBm, -15.0 dBm, -15.0 dBm -12.5 dBm, -12.5 dBm, -24.5 dBm, -11.5 dBm, -15.0 dBm, -15.0 dBm, -15.0 dBm, -15.0 dBm, -15.0 dBm, -15.0 dBm, -15.0 dBm, -15.0 dBm</p>
State Saved	Saved in instrument state.
Min	-200 dBm
Max	50 dBm
Initial S/W Revision	Prior to A.02.00

Spectrum Emission Mask Measurement
Meas Setup

Modified at S/W Revision	A.02.00, A.03.00, A.10.01
--------------------------	---------------------------

Abs Stop

Sets the absolute power level limit at the stop frequency for the selected offset. The absolute power level limit ranges from –200 to +50 dBm. You can also toggle this function between couple and manual. If set to Couple, the **Abs Stop** power level limit is coupled to **Abs Start** to result in a flat limit line. If set to Man, Abs Start and Abs Stop take different values to result in a sloped limit line.

The SCPI query returns the five (5) sets of real values currently set to the offset stop absolute power limits.

Key Path	Meas Setup, Offset/Limit, Limits
Mode	SA, WCDMA, C2K, WIMAX OFDMA, TD-SCDMA, 1xEVDO, DTMB (CTTB), DVB-T/H, ISDB-T, CMMB, LTE, LTETDD, Digital Cable TV, WLAN, MSR
Remote Command	<pre>[:SENSE]:SEMAsk:OFFSet[1] 2:LIST:STOP:ABSolute <real>, ... [:SENSE]:SEMAsk:OFFSet[1] 2:LIST:STOP:ABSolute? [:SENSE]:SEMAsk:OFFSet[1] 2:LIST:STOP:ABSolute:COUple ON OFF 1 0, ... [:SENSE]:SEMAsk:OFFSet[1] 2:LIST:STOP:ABSolute:COUple?</pre>
Example	<pre>SEM:OFFS:LIST:STOP:ABS -12.50 dBm, -24.50 dBm, -24.50 dBm, -11.50 dBm, -11.50 dBm, -11.50 dBm SEM:OFFS1:LIST:STOP:ABS? SEM:OFFS:LIST:STOP:ABS:COUP ON, OFF, ON, ON, ON, ON SEM:OFFS:LIST:STOP:ABS:COUP?</pre>
Notes	<p>Comma separated list of 12 values for MSR and 6 values for other modes. OFFSet1 is for BTS, 2 for MS. Default is BTS.</p> <p>You must be in the mode that includes SEM measurement to use this command. Use :INSTrument:SElect to set the mode.</p>
Couplings	<p>Coupled to Abs Start if coupling set to “Couple”, that is, the Stop value is equal to the Start value.</p> <p>If the current mode is DVB-T/H, this value will be modified automatically according to the limit type and the output power of the transmitter which is less or more than 25W.</p> <p>If the current mode is ISDB-T, this value will be modified automatically according to the limit type.</p>

Preset	<p>SA, WIMAX OFDMA: -14.00 dBm, -26.00 dBm, -26.00 dBm, -13.00 dBm, -13.00 dBm, -13.00 dBm</p> <p>WCDMA: -12.50 dBm, -24.50 dBm, -24.50 dBm, -11.50 dBm, -11.50 dBm, -11.50 dBm -69.6 dBm, -54.3 dBm, -54.3 dBm, -54.3 dBm, -54.3 dBm, -54.3 dBm</p> <p>C2K: -27.00 dBm, -27.00 dBm, -27.00 dBm, -46.00 dBm, -13.00 dBm, -13.00 dBm -70.13 dBm, -70.13 dBm, -35.00 dBm, -13.00 dBm, -13.00 dBm, -13.00 dBm</p> <p>TD-SCDMA: -28 dBm, -36 dBm, -36 dBm, -21 dBm, -21 dBm, -21 dBm -71.3 dBm, -71.3 dBm, -56.07 dBm, -56.07 dBm, -56.07 dBm, -56.07 dBm</p> <p>1xEVDO: -27dBm, -27.00 dBm, -27.00 dBm, -46.00 dBm, -13.00 dBm, -13.00 dBm -70.13 dBm, -70.13 dBm, -70.13 dBm, -70.13 dBm, -70.13 dBm, -70.13 dBm</p> <p>DTMB (CTTB): -14.0 dBm, -26.0 dBm, -26.0 dBm, -13.0 dBm, -13.0 dBm, -13.0 dBm</p> <p>DVB-T/H: -29 dBm, -41 dBm, -66 dBm, -82 dBm, -82 dBm, -82 dBm</p> <p>ISDB-T: 50.0 dBm, 50.0 dBm, 50.0 dBm, 50.0 dBm, 50.0 dBm, 50.0 dBm</p> <p>CMMB: 50.0 dBm, 50.0 dBm, 50.0 dBm, 50.0 dBm, 50.0 dBm, 50.0 dBm</p> <p>LTE, LTETDD:-12.5 dBm, -12.5 dBm, -15.0 dBm, -15.0 dBm, -15.0 dBm, -15.0 dBm -13.5 dBm, -8.5 dBm, -11.5 dBm, -23.5 dBm, -23.5 dBm, -23.5 dBm</p> <p>Digital Cable TV: 50.0 dBm, 50.0 dBm, 50.0 dBm, 50.0 dBm, 50.0 dBm, 50.0 dBm</p> <p>WLAN:</p> <p style="padding-left: 20px;">if Radio Std is 802.11a/g(OFDM/DSSS-OFDM): -4.00 dBm, -12.00 dBm, -24.00 dBm, -24.00 dBm, -24.00 dBm, -24.00 dBm</p> <p style="padding-left: 20px;">if Radio Std is 802.11b/g(DSSS/CCK/PBCC): -10 dBm, -30 dBm, -30 dBm, -30 dBm, -30 dBm, -30 dBm</p> <p style="padding-left: 20px;">if Radio Std is 802.11n(20 MHz): -4.00 dBm, -12.00 dBm, -24.00 dBm, -63.00 dBm, -63.00 dBm, -63.00 dBm</p> <p style="padding-left: 20px;">if Radio Std is 802.11n(40 MHz): -4.00 dBm, -12.00 dBm, -24.00 dBm, -66.00 dBm, -66.00 dBm, -66.00 dBm</p> <p>MSR:-12.5 dBm, -24.5 dBm, -11.5 dBm, -15.0 dBm, -15.0 dBm, -15.0 dBm, -15.0 dBm, -15.0 dBm, -15.0 dBm, -15.0 dBm, -15.0 dBm, -15.0 dBm -12.5 dBm, -24.5 dBm, -11.5 dBm, -15.0 dBm, -15.0 dBm, -15.0 dBm, -15.0 dBm, -15.0 dBm, -15.0 dBm, -15.0 dBm, -15.0 dBm, -15.0 dBm</p>
--------	--

Spectrum Emission Mask Measurement
Meas Setup

Preset (continued)	SA, WIMAX OFDMA: ON, OFF, ON, ON, ON, ON, ON WCDMA: ON, OFF, ON, ON, ON, ON ON, ON, ON, ON, ON, ON C2K: ON, ON, ON, ON, ON, OFF ON, ON, ON, ON, ON, OFF TD-SCDMA: ON, OFF, ON, ON, ON, ON ON, ON, ON, ON, ON, ON 1xEVDO: ON, ON, ON, ON, ON, OFF ON, ON, ON, ON, ON, OFF DTMB (CTTB): ON, OFF, ON, ON, ON, ON DVB-T/H: OFF, OFF, OFF, OFF, OFF, OFF ISDB-T: OFF, OFF, OFF, OFF, OFF, OFF CMMB: OFF, OFF, OFF, OFF, OFF, OFF LTE, LTETDD: OFF, ON, ON, ON, ON, ON ON, ON, ON, ON, ON, ON Digital Cable TV: OFF, OFF, OFF, OFF, OFF, OFF WLAN: if Radio Std is 802.11a/g(OFDM/DSSS-OFDM)/802.11n(20MHz/40MHz): OFF, OFF, OFF, ON, ON, ON if Radio Std is 802.11b/g(DSSS/CCK/PBCC): ON, ON, ON, ON, ON, ON MSR: ON, ON, ON, ON, ON, OFF, OFF, OFF, OFF, OFF, OFF, OFF ON, ON, ON, ON, ON, OFF, OFF, OFF, OFF, OFF, OFF, OFF
State Saved	Saved in instrument state.
Min	-200 dBm
Max	50 dBm
Initial S/W Revision	Prior to A.02.00
Modified at S/W Revision	A.02.00, A.03.00, A.10.01

Rel Start

Sets a relative power level limit at the start frequency for the selected offset. The relative power level limit ranges from -200 to +50 dBc.

The fail condition is set remotely by [:SENSE]:SEMask:OFFSet[n]:LIST:TEST for each offset channel test.

You can turn off (not use) specific offset channels remotely with [:SENSE]:SEMask:OFFSet[n]:LIST:STATe.

The SCPI query returns the five (5) sets of real values currently set to the relative power test limits.

Key Path	Meas Setup, Offset/Limit, Limits
Mode	SA, WCDMA, C2K, WIMAX OFDMA, TD-SCDMA, 1xEVDO, DTMB (CTTB), DVB-T/H, ISDB-T, CMMB, LTE, LTETDD, Digital Cable TV, WLAN, MSR

Remote Command	<pre>[:SENSE]:SEMask:OFFSet[1] 2:LIST:STARt:RCARrier <rel_amp1>, ... [:SENSE]:SEMask:OFFSet[1] 2:LIST:STARt:RCARrier?</pre>
Example	<pre>SEM:OFFS:LIST:STAR:RCAR -30, -30, -30, -30, -30, -30 SEM:OFFS:LIST:STAR:RCAR?</pre>
Notes	<p>See the following table for the default values for each Radio Standard.</p> <p>Comma separated list of 12 values for MSR and 6 values for other modes. OFFSet1 is for BTS, 2 for MS. Default is BTS.</p> <p>You must be in the mode that includes SEM measurement to use this command. Use :INSTrument:SElect to set the mode.</p>
Couplings	<p>Coupled to Rel Stop is coupling set to “Couple”, that is, Start is made the same as Stop.</p> <p>If the current mode is DVB-T/H, this value will be modified automatically according to the limit type the output power of the transmitter which is less or more than 25W.</p> <p>If the current mode is ISDB-T, this value will be modified automatically according to the limit type.</p>

You can turn off (not use) specific offset channels remotely with
[:SENSe]:SEMAsk:OFFSet[n]:LIST:STATe.

The SCPI query returns the five (5) sets of real values currently set to the offset stop relative power limits.

Key Path	Meas Setup, Offset/Limit, Limits
Mode	SA, WCDMA, C2K, WIMAX OFDMA, TD-SCDMA, 1xEVDO, DTMB (CTTB), DVB-T/H, ISDB-T, CMMB, LTE, LTETDD, Digital Cable TV, WLAN, MSR
Remote Command	<pre>[:SENSe]:SEMAsk:OFFSet[1] 2:LIST:STOP:RCARrier <rel_ampl>, ... [:SENSe]:SEMAsk:OFFSet[1] 2:LIST:STOP:RCARrier? [:SENSe]:SEMAsk:OFFSet[1] 2:LIST:STOP:RCARrier:COUPLE ON OFF 1 0, ... [:SENSe]:SEMAsk:OFFSet[1] 2:LIST:STOP:RCARrier:COUPLE?</pre>
Example	<pre>SEM:OFFS:LIST:STOP:RCAR -30, -30, -30, -30, -30, -30 SEM:OFFS:LIST:STOP:RCAR? SEM:OFFS:LIST:STOP:RCAR:COUP ON, ON, ON, ON, ON, ON SEM:OFFS:LIST:STOP:RCAR:COUP?</pre>
Notes	<p>See the following table for the default values for each Radio Standard.</p> <p>Comma separated list of 12 values for MSR and 6 values for other modes. OFFSet1 is for BTS, 2 for MS. Default is BTS.</p> <p>You must be in the mode that includes SEM measurement to use this command. Use :INSTrument:SELect to set the mode.</p>
Couplings	<p>Coupled to Rel Start if coupling set to “Couple”, that is, Start is made the same as Stop.</p> <p>If the current mode is DVB-T/H, this value will be modified automatically according to the limit type and the output power of the transmitter which is less or more than 25W.</p> <p>If the current mode is ISDB-T, this value will be modified automatically according to the limit type.</p>

Preset (continued)	SA: ON, ON, ON, ON, ON, ON WCDMA: ON, ON, ON, ON, ON, ON, ON OFF, OFF, OFF, ON, ON, ON C2K: ON, ON, ON, ON, ON, OFF ON, ON, ON, ON, ON, OFF WIMAX OFDMA: OFF, OFF, OFF, ON, ON, ON OFF, OFF, OFF, ON, ON, ON TD-SCDMA: ON, OFF, ON, ON, ON, ON OFF,OFF,ON,ON,ON,ON 1xEVDO: ON, ON, ON, ON, ON, OFF ON, ON, ON, ON, ON, OFF DTMB (CTTB): OFF, OFF, OFF, OFF, OFF, OFF DVB-T/H: ON, ON, ON, ON, ON, ON ISDB-T: OFF, OFF, OFF, OFF, OFF, OFF CMMB: OFF, OFF, OFF, OFF, OFF, OFF LTE, LTETDD: ON, ON, ON, ON, ON, ON Digital Cable TV: OFF, OFF, OFF, OFF, OFF, OFF WLAN: if Radio Std is 802.11a/g(OFDM/DSSS-OFDM)/802.11n(20MHz/40MHz): OFF, OFF, OFF, ON, ON, ON if Radio Std is 802.11b/g(DSSS/CCK/PBCC): ON, ON, ON, ON, ON, ON MSR: ON, ON, ON, ON, ON, ON, ON, ON, ON, ON, ON, ON ON, ON, ON, ON, ON, ON, ON, ON, ON, ON, ON, ON
State Saved	Saved in instrument state.
Min	-200 dB
Max	50 dB
Initial S/W Revision	Prior to A.02.00
Modified at S/W Revision	A.02.00, A.03.00, A.10.01

Fail Mask

Selects one of the logic keys for fail conditions between the measurement results and the test limits:

- **Absolute** and **Relative** both check the results against the respective limit.
- **OR** checks against both limits, failing if either of the limits is broken.
- **AND** will only display a fail if both of the limits are broken.

The absolute or relative power limit value for each offset channel can be set remotely with
[:SENSe]:SEMask:OFFSet[n]:LIST:ABSolute or [:SENSe]:SEMask:OFFSet[n]:LIST:RCARrier.

You can turn off (not use) specific offset channels remotely with
[:SENSe]:SEMask:OFFSet[n]:LIST:STATe.

Key Path	Meas Setup, Offset/Limit, Limits
----------	---

Spectrum Emission Mask Measurement
Meas Setup

Mode	SA, WCDMA, C2K, WIMAX OFDMA, TD-SCDMA, 1xEVDO, DTMB (CTTB), DVB-T/H, ISDB-T, CMMB, LTE, LTETDD, Digital Cable TV, WLAN, MSR
Remote Command	[:SENSe] :SEMAsk:OFFSet [1] 2 :LIST:TEST ABSolute AND OR RELative, ... [:SENSe] :SEMAsk:OFFSet [1] 2 :LIST:TEST?
Example	SEM:OFFS:LIST:TEST ABS, ABS, ABS, ABS, ABS, ABS SEM:OFFS:LIST:TEST?
Notes	See the following table for the default values for each Radio Standard. Comma separated list of 12 values for MSR and 6 values for other modes. You must be in the mode that includes SEM measurement to use this command. Use :INSTRument:SELEct to set the mode.
Couplings	None If the current mode is DVB-T/H, this value will be modified automatically according to the limit type and the output power of the transmitter which is less or more than 25W.
Preset	SA: ABS, ABS, ABS, ABS, ABS, ABS WCDMA: ABS, ABS, ABS, ABS, ABS, ABS, ABS AND, AND, AND, AND, AND, AND C2K: REL, REL, REL, ABS, REL, REL AND, AND, ABS, REL, REL, REL WIMAX OFDMA: REL, REL, REL, REL, REL, REL REL, REL, REL, REL, REL, REL TD-SCDMA: ABS, ABS, ABS, ABS, ABS, ABS AND, AND, AND, AND, AND, AND 1xEVDO: REL, REL, REL, ABS, REL, REL AND, AND, AND, OR, AND, AND DTMB (CTTB): REL, REL, REL, REL, REL, REL DVB-T/H: ABS, ABS, ABS, ABS, ABS, ABS ISDB-T: REL, REL, REL, REL, REL, REL CMMB: REL, REL, REL, REL, REL, REL LTE: ABS, ABS, ABS, ABS, ABS, ABS LTETDD: ABS, ABS, ABS, ABS, ABS, ABS Digital Cable TV: REL, REL, REL, REL, REL, REL WLAN: if Radio Std is 802.11a/g(OFDM/DSSS-OFDM) or 802.11b/g(DSSS/CCK/PBCC): REL, REL, REL, REL, REL, REL if Radio Std is 802.11n(20 MHz / 40 MHz): REL, REL, REL, OR, OR, OR MSR: ABS, ABS, ABS, ABS, ABS, ABS, ABS, ABS, ABS, ABS, ABS, ABS, ABS, ABS

State Saved	Saved in instrument state.
Range	Absolute Relative Abs AND Rel Abs OR Rel
Initial S/W Revision	Prior to A.02.00
Modified at S/W Revision	A.02.00, A.03.00, A.10.01

Method

Sets the measurement method

Integ BW-enables you to set the channel integration bandwidth.

RRC Weight-selects Root Raised Cosine (RRC) filtering of the carriers. The α value (rolloff) for the filter is set to the value of the Filter Alpha parameter.

Key Path	Meas Setup
Mode	SA, WCDMA, WIMAX OFDMA, TD-SCDMA, DTMB (CTTB), DVB-T/H, ISDB-T, CMMB, LTE, LTETDD, Digital Cable TV, WLAN, MSR
Remote Command	[:SENSe] :SEMAsk :FILTer [:RRC] [:STATe] OFF ON 0 1 [:SENSe] :SEMAsk :FILTer [:RRC] [:STATe] ?
Example	SEM:FILT ON SEM:FILT?
Notes	For the CDMA2K and CDMA1xEVDO mode, this key is not available. 1 ON = RRC Weight, 0 OFF = IntegBW You must be in the mode that includes SEM measurement to use this command. Use :INSTrument:SElect to set the mode.
Preset	SA, WIMAX OFDMA, DVB-T/H, ISDB-T, CMMB, LTE, LTETDD, WLAN, MSR: OFF WCDMA, TD-SCDMA, DTMB (CTTB), Digital Cable TV: ON
State Saved	Saved in instrument state.
Range	RRCWeight IntegBW
Initial S/W Revision	Prior to A.02.00
Modified at S/W Revision	A.02.00, A.03.00

Filter Alpha

Sets the alpha value for the RRC Filter.

Key Path	Meas Setup
Mode	SA, WCDMA, WIMAX OFDMA, TD-SCDMA, DTMB (CTTB), DVB-T/H, ISDB-T, CMMB, LTE, LTETDD, Digital Cable TV, MSR

Spectrum Emission Mask Measurement
Meas Setup

Remote Command	[:SENSe]:SEMAsk:FILTer[:RRC]:ALPHa <real> [:SENSe]:SEMAsk:FILTer[:RRC]:ALPHa?
Example	SEM:FILT:ALPH 0.3 SEM:FILT:ALPH?
Notes	For the CDMA2K and CDMA1xEVDO mode, this key is not available. You must be in the mode that includes SEM measurement to use this command. Use :INSTrument:SElect to set the mode.
Preset	0.22 DTMB (CTTB): 0.05 Digital Cable TV: 0.15
State Saved	Saved in instrument state.
Min	0.01
Max	1.0
Initial S/W Revision	Prior to A.02.00
Modified at S/W Revision	A.02.00, A.03.00

Meas Preset

Restores all the measurement parameters to their default values.

Key Path	Meas Setup
Mode	SA, WCDMA, C2K, WIMAX OFDMA, TD-SCDMA, 1xEVDO, DTMB (CTTB), DVB-T/H, ISDB-T, CMMB, LTE, LTE-TDD, Digital Cable TV, WLAN, MSR
Remote Command	:CONFIgure:SEMAsk
Example	CONF:SEM
Notes	You must be in the mode that includes SEM measurement to use this command. Use :INSTrument:SElect to set the mode.
Couplings	Selecting Meas Preset will restore all measurement parameters to their default values.
Initial S/W Revision	Prior to A.02.00
Modified at S/W Revision	A.02.00, A.03.00

Limit State(Only for TD-SCDMA)

The key “Limits State” is only displayed in the TD-SCDMA mode. The mask lines could be drawn in two different ways, according to the 3GPP standard for the base station when the key’s value is “Std”; or

by the user-defined specifications listed in the Offset/Limits menu.

Key Path	Meas Setup
Mode	TD-SCDMA
Remote Command	[:SENSe] :SEMAsk :LIMits STD MAN [:SENSe] :SEMAsk :LIMits?
Example	SEM:LIM STD SEM:LIM?
Notes	You must be in the TD-SCDMA mode to use this command. Use :INSTrument:SElect to set the mode.
Dependencies	See Couplings
Couplings	When the value of the “Limits” key is Std, the parameters displayed on the Offset/Limits panel will be modified depending on the carrier power, which corresponds to the measurement standard of the base station. All the keys except “Offset”, “Relative Atten”, “Offset Side” and “Limits” displayed on the “Offset/Limits” panel will be grayed out. All the keys displayed on the “Limits” panel will be grayed out as well. When the value of the “Limits” key is Man, all of the previous manual specifications will be restored, and the keys that were previously grayed out will be enabled again.
Preset	MAN
State Saved	Saved in instrument state.
Range	STD MAN
Initial S/W Revision	Prior to A.02.00

Limit Type (Only for DVB-T/H)

This key is only displayed in the DVB-T/H mode. The mask lines could be drawn in three different ways:

1. according to the non-critical case standard in ETSI 302–296 when the key’s value is “Non-Critical”
2. according to the critical case standard in ETSI 302–296 when the key’s value is “Critical”
3. specifications listed in the Offset/Limits menu or by the user-defined when the key’s value is “Manual”.

Key Path	Meas Setup
Mode	DVB-T/H
Remote Command	[:SENSe] :SEMAsk :LIMits :TYPE MANual NONCritical CRITical [:SENSe] :SEMAsk :LIMits :TYPE?

Spectrum Emission Mask Measurement
Meas Setup

Example	SEM:LIM:TYPE NONC SEM:LIM:TYPE?
Notes	You must be in the DVB-T/H mode to use this command. Use :INSTrument:SElect to set the mode.
Couplings	<ol style="list-style-type: none"> 1. When current radio bandwidth is 5 MHz or 6 MHz, this key only has one option: Manual. The “Non-Critical” and “Critical” keys will be grayed out. So the default value is Manual after measurement preset. 2. When current radio bandwidth is 7 MHz or 8 MHz, this key has three options: Manual, Non-Critical and Critical. The default value is Non-Critical after measurement preset. <ol style="list-style-type: none"> a. When the value of the “Limit Type” key is Non-Critical, the parameters displayed on the Offset/Limits panel will be modified automatically depending on the carrier power, according to the Non-critical case limits definition in ETSI 302–296, and the keys under the Offset/Limit except “Offset”, “Offset Side” and “Limits” will be grayed out. Meanwhile all the keys displayed on the “Limits” panel will be grayed out as well. b. When the value of the “Limit Type” key is Critical, the parameters displayed on the Offset/Limits panel will be modified automatically depending on the carrier power, according to the critical case limits definition in ETSI 302–296, and the keys under the Offset/Limit except “Offset”, “Offset Side” and “Limits” will be grayed out. Meanwhile all the keys displayed on the “Limits” panel will be grayed out as well. c. When the value of the “Limit Type” key is Manual, all of the previous manual specifications will be restored, and the keys that were previously grayed out will be enabled again.
Preset	NONCritical (if current radio bandwidth is 7 MHz or 8 MHz) Manual (if current radio bandwidth is 5 MHz or 6 MHz)
State Saved	Saved in instrument state.
Range	Manual Non-Critical Critical
Initial S/W Revision	A.02.00

Limit Type (Only for ISDB-T)

This key is only displayed in the ISDB-T mode. The mask lines could be drawn in six different ways according to the following:

1. JEITA, Limit Masks defined in ARIB-STD B31 Version 1.7, Transmission System For Digital Terrestrial Television Broadcasting
2. Non-critical case defined in Brazil ABNT NBR15601, Digital terrestrial television – Transmission systems
3. Sub-critical case defined in Brazil ABNT NBR15601

4. Critical case defined in Brazil ABNT NBR15601
5. ISDB-Tsb case defined in ARIB STD-B29, “Transmission System for Digital Terrestrial Sound Broadcasting”
6. User-defined

The mask lines for JEITA are listed in “JEITA” on page 790.

The mask lines for 2 (Non-critical case), 3 (Sub-critical case),4 (Critical case) are listed in the following table.

Separation in relation to the digital signal central carrier	Minimum attenuation in relation to average power, measured at carrier central frequency		
	Non-critical mask	Sub-critical mask	Critical mask
±2.79 MHz	0.0 dB	0.0 dB	0.0 dB
±2.86 MHz	20.0 dB	20.0 dB	20.0 dB
±3.00 MHz	27.0 dB	34.0 dB	34.0 dB
±3.15 MHz	36.0 dB	43.0 dB	50.0 dB
±4.5 MHz	53.0 dB	60.0 dB	67.0 dB
±9.0 MHz	83.0 dB	90.0 dB	97.0 dB
±15.0 MHz	83.0 dB	90.0 dB	97.0 dB

The mask lines for 5 (ISDB-Tsb case) are listed below.

1-Segment

Difference from carrier frequency	Attenuation from the average power, P	Specification
±220 kHz	-16.3 dB/10 kHz	upper limit
±290 kHz	-36.3 dB/10 kHz	upper limit
±360 kHz	-46.3 dB/10 kHz	upper limit
±1170 kHz	-52.0 dB/10 kHz; ($P \leq 0.5$ W) -(53.6 + 5.6logP) dB/10 kHz; (0.5 W < $P \leq 5.0$ W) -57.6 dB/10 kHz; ($P > 5.0$ W)	upper limit

3-Segment

Difference from carrier frequency	Attenuation from the average power, P	Specification
±650 kHz	-21.0 dB/10 kHz	upper limit

Spectrum Emission Mask Measurement
Meas Setup

Difference from carrier frequency	Attenuation from the average power, P	Specification
±720 kHz	-41.0 dB/10 kHz	upper limit
±790 kHz	-51.0 dB/10 kHz	upper limit
±2220 kHz	-61.0 dB/10 kHz; (P≤0.5 W) -61.0+10log(P/0.5) dB/10 kHz; (0.5 W<P≤5.0 W) -71.0 dB/10 kHz; (P>5.0 W)	upper limit

Key Path	Meas Setup
Mode	ISDB-T
Remote Command	[:SENSE] :SEMAsk:LIMits:TYPE MANual JEITa ANONcriticalASUBcritical ACritical TSB [:SENSE] :SEMAsk:LIMits:TYPE?
Example	SEM:LIM:TYPE JEIT SEM:LIM:TYPE?
Notes	You must be in the ISDB-T mode to use this command. Use :INSTrument:SElect to set the mode.

Couplings	<p>1. When current radio standard is ISDB-T, this key has five options: “Manual”, “JEITA”, “ABNT Non-Critical”, “ABNT Sub-Critical” and “ABNT Critical”. The “ISDB-Tsb” key will be grayed out. The default value is “JEITA” after measurement preset</p> <p>a. When the value of the “Limit Type” key is “JEITA”, there are four options: “Auto Sense”, “30dB Mask”, “40dB Mask” and “50dB Mask”.</p> <p>If “Auto Sense” is selected, the parameters displayed on Offset/Limits panel will be modified automatically depending on the total reference power, according to the spectrum mask definition in ARIB-STD B31, Version 1.7, and all the keys under the Offset/Limit except “Select Offset” and “Limits” will be grayed out.</p> <p>If “30dB Mask” key is selected, the 30dB mask will be applied.</p> <p>If “40dB Mask” key is selected, the 40dB mask will be applied.</p> <p>If “50dB Mask” key is selected, the 50dB mask will be applied.</p> <p>b. When the value of the “Limit Type” key is “ABNT Non-Critical”, the parameters displayed on Offset/Limits panel will be modified automatically according to the Non-critical mask definition in Brazil “ABNT NBR 15601, and all keys under the Offset/Limit except “Select Offset” and “Limits” will be grayed out.</p> <p>c. When the value of the “Limit Type” key is “ABNT Sub-Critical”, the parameters displayed on Offset/Limits panel will be modified automatically according to the Sub-critical mask definition in Brazil “ABNT NBR 15601, and the keys under the Offset/Limit except “Select Offset” and “Limits” will be grayed out.</p> <p>d. When the value of the “Limit Type” key is “ABNT Critical”, the parameters displayed on Offset/Limits panel will be modified automatically according to the Critical mask definition in Brazil “ABNT NBR 15601, and all keys under the Offset/Limit except “Select Offset” and “Limits” will be grayed out.</p> <p>e. When the value of the “Limit Type” key is “Manual”, the parameters displayed on the Offset/Limits panel can be modified manually. When changing the “Limit Type” key from “Manual” to others, the current settings will be stored.</p>
-----------	--

Spectrum Emission Mask Measurement
Meas Setup

Couplings (continued)	<p>2. When current radio standard is ISDB-Tsb, this key has only two options: “Manual” and “ISDB-Tsb”. The default value is “ISDB-Tsb” after measurement preset.</p> <p>a. When the value of the “Limit Type” key is “ISDB-Tsb”, the parameters displayed on the Offset/Limits panel will be modified automatically depending on the output signal power and the value of “Segment Number” under “Mode Setup” panel, according to the spectrum mask definition in ARIB STD-B29, and all keys under the Offset/Limit except “Select Offset” and “Limits” will be grayed out.</p> <p>b. When the value of the “Limit Type” key is “Manual”, the parameters displayed on the Offset/Limits panel can be modified manually. When changing the “Limit Type” key from “Manual” to others, the current settings will be stored.</p>
Preset	<p>JEITa (if current radio standard is ISDB-T)</p> <p>TSB (if current radio standard is ISDB-Tsb)</p>
State Saved	Saved in instrument state.
Range	Manual ABNT Non-Critical ABNT Sub-Critical ABNT Critical ISDB-Tsb
Initial S/W Revision	A.03.00
Modified at S/W Revision	A.06.00

JEITA

Selects JEITA as limit type, which means the Limit Masks defined in ARIB-STD B31 Version 1.7 will be used. Four options, Auto Sense, 30dB Mask, 40dB Mask, 50dB Mask, are available, which refer to four types of limitations for ±4.36MHz difference from carrier frequency.

Difference from carrier frequency	Attenuation from the average power, P	Specification
±2.79 MHz	-27.4 dB/10 kHz	upper limit
±2.86 MHz	-47.4 dB/10 kHz	upper limit
±3.00 MHz	-54.4 dB/10 kHz	upper limit
±4.36 MHz	<p>$P \leq 0.025 \text{ W}$, -57.4 dB/10 kHz</p> <p>$0.025 \text{ W} < P < 0.25 \text{ W}$, $-(73.4 + 10 * \log P)$ dB/ 10kHz</p> <p>$P = 0.25 \text{ W}$, -67.4 dB/10 kHz</p> <p>$0.25 \text{ W} < P \leq 2.5 \text{ W}$, $-(73.4 + 10 * \log P)$ dB/10 kHz</p> <p>$P > 2.5 \text{ W}$, -77.4 dB/10 kHz</p>	upper limit

Auto Sense means the instrument will auto-detect average power P to set the limit for ± 4.36 MHz frequency offset.

30dB Mask means the attenuation from the average power at ± 4.36 MHz frequency offset is -57.4 dB/10 kHz.

40dB Mask means the attenuation from the average power at ± 4.36 MHz frequency offset is -67.4 dB/10 kHz.

50dB Mask means the attenuation from the average power at ± 4.36 MHz frequency offset is -77.4 dB/10 kHz.

The following table lists the cases to use the four masks.

Channel Power P	Is adjacent channel used for analog TV?	Is the Analog TV power more than or equal to ten times the channel power?	Attenuation at ± 4.36 MHz frequency offset	Mask to be used
$P \geq 2.5$ W	Yes/No	Yes/No	-77.4 dB/10 kHz	Auto Sense
2.5 W $\geq P > 0.25$ W	No	None	$-(73.4 + 10\log P)$ dB/10 KHz	Auto Sense
	Yes	Yes	$-(73.4 + 10\log P)$ dB/10 KHz	Auto Sense
	Yes	No	-77.4 dB/10 kHz	50dB Mask
0.25 W $\geq P > 0.025$ W	No	None	$-(73.4 + 10\log P)$ dB/10 KHz	Auto Sense
	Yes	Yes	-67.4 dB/10 kHz	40dB Mask
	Yes	No	-77.4 dB/10 kHz	50dB Mask
0.025 W $\geq P$	No	None	-57.4 dB/10 kHz	Auto Sense
	Yes	Yes	-67.4 dB/10 kHz	40dB Mask
	Yes	No	-77.4 dB/10 kHz	50dB Mask

Key Path	Meas Setup, Limit Type
Mode	ISDB-T
Remote Command	[:SENSE] :SEMAsk :LIMits :TYPE :JEITA ASENSE J30Mask J40Mask J50Mask [:SENSE] :SEMAsk :LIMits :TYPE :JEITA?
Example	SEM:LIM:TYPE:JEIT ASEN SEM:LIM:TYPE:JEIT?
Notes	You must be in the ISDB-T mode to use this command. Use :INSTrument:SElect to set the mode.

Couplings	<ol style="list-style-type: none"> 1. If “Auto Sense” is selected, the parameters displayed on the Offset/Limits panel will be modified automatically depending on the total reference power, according to the spectrum mask definition in ARIB-STD B31, Version 1.7, and the keys under the Offset/Limit except “Select Offset” and “Limits” will be grayed out. 2. If “30 dB Mask” is selected, the 30 dB mask will be applied. 3. If “40 dB Mask” is selected, the 40 dB mask will be applied. 4. If “50 dB Mask” is selected, the 50 dB mask will be applied.
Preset	ASENSE
State Saved	Saved in instrument state
Range	Auto Sense 30dB Mask 40dB Mask 50dB Mask
Initial S/W Revision	A.06.00

Offset Freq Define

This key enables you to select “Offset” definition. Each standard defines each “Offset” from Carrier.

Meas BW Edge means the edge of resolution band width that is represented by Meas BW and Res BW settings. Actual center frequency of Meas BW and the limit line have ½ Meas BW offset when the Meas BW Edge is selected.

3GPP2 requires the “Carrier Center to Meas BW Edge” definition. LTE conformance test requires “Carrier Edge to Meas BW Center” and/or “Carrier Edge to Meas BW Edge” definition

- CTOCenter – From carrier center to the center of offset measuring filter*
- CTOEdge - From carrier center to the nominal –3 dB point of the offset measuring filter* closer to the carrier
- ETOCenter – From Center Frequency - Span of Ref Channel / 2 (for lower offset), Center Frequency + Span of Ref Channel / 2 (for upper offset) of the carrier closest to each offset to the center of offset measuring filter*
- ETOEdge - From Center Frequency - Span of Ref Channel / 2 (for lower offset), Center Frequency + Span of Ref Channel / 2 (for upper offset) of the carrier closest to each offset to the nominal –3 dB point of the offset measuring filter* closer to the carrier

*Measuring filter = Meas BW (N x Res BW)

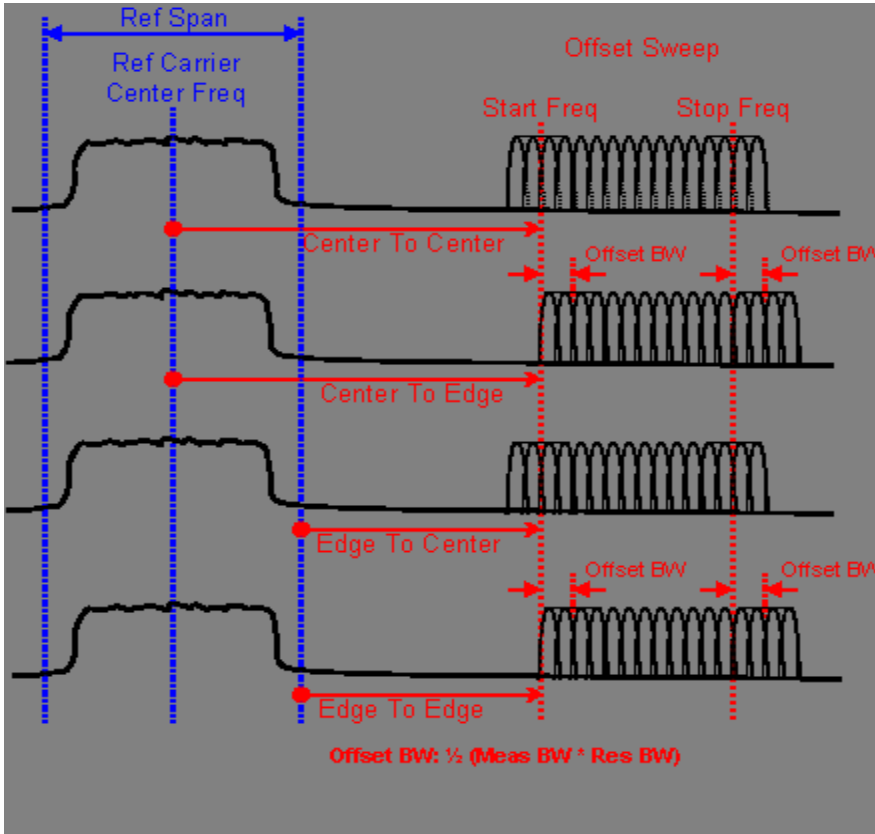

The figure above shows Offset Freq Definition in SEM measurement

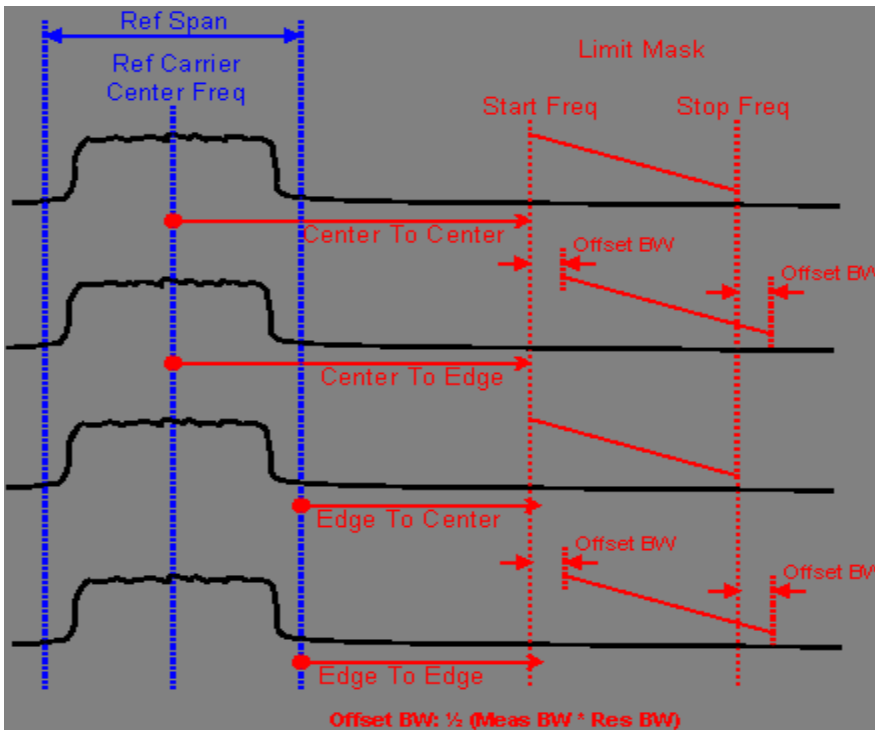

Spectrum Emission Mask Measurement
Meas Setup

The figure above shows Offset Freq Definition (Limit Mask) in SEM measurement

Key Path	Meas Setup, Offset/Limits
Mode	SA, WCDMA, C2K, WIMAX OFDMA, TD-SCDMA, 1xEVDO, DVB-T/H, DTMB (CTTB), ISDB-T, CMMB, LTE, LTETDD, Digital Cable TV, WLAN, MSR
Remote Command	[:SENSE] :SEMAsk:OFFSet [1] 2 :TYPE CTOCenter CTOEdge ETOCenter ETOEdge [:SENSE] :SEMAsk:OFFSet [1] 2 :TYPE?
Example	SEM:OFFS:TYPE ETOC SEM:OFFS:TYPE?
Notes	You must be in the mode that includes SEM measurements to use this command. Use :INSTrument:SELect to set the mode.
Preset	SA, WCDMA, WIMAX OFDMA, TD-SCDMA, DVB-T/H, DTMB (CTTB), ISDB-T, CMMB, Digital Cable TV: CTOC C2K: CTOE 1xEVDO: CTOE LTE, MSR: ETOC LTETDD: ETOC
State Saved	Saved in instrument state.
Range	Carrier Center To Meas BW Center Carrier Center To Meas BW Edge Carrier Edge To Meas BW Center Carrier Edge To Meas BW Edge
Initial S/W Revision	A.03.00

Offset Freq Define (Only for MSR)

This key enables you to select “Offset” definition. Each standard defines each “Offset” from Carrier.

Meas BW Edge means the edge of resolution band width that is represented by Meas BW and Res BW settings. Actual center frequency of Meas BW and the limit line have ½ Meas BW offset when the Meas BW Edge is selected.

3GPP2 requires the “Carrier Center to Meas BW Edge” definition, and LTE conformance test requires “Carrier Edge to Meas BW Center” and/or “Carrier Edge to Meas BW Edge” definition. MSR standard requires “RFBW Edge to Meas BW Center” and/or “RFBW Edge to Meas Edge” definition.

- CTOC – From the lowermost carrier frequency (for lower offset), the uppermost carrier frequency (for upper offset) to the center of offset measuring filter*
- CTOE - From the lowermost carrier frequency (for lower offset), the uppermost carrier frequency (for upper offset) to the nominal –3 dB point of the offset measuring filter* closer to the carrier
- ETOC – From the lowermost carrier frequency - spacing of this carrier /2 (for lower offset), the uppermost carrier frequency + spacing of this carrier /2 (for upper offset) to the center of offset measuring filter*

- ETOE - From the lowermost carrier frequency - spacing of this carrier /2 (for lower offset), the uppermost carrier frequency + spacing of this carrier /2 (for upper offset) to the nominal -3 dB point of the offset measuring filter* closer to the carrier
- RTOC – From either the lower or upper RFBW edges to the center of offset measuring filter*
- RTOE – From either the lower or upper RFBW edges to the nominal -3 dB point of the offset measuring filter* closer to the carrier

*Measuring filter = Meas BW (N x Res BW)

Spectrum Emission Mask Measurement
Meas Setup

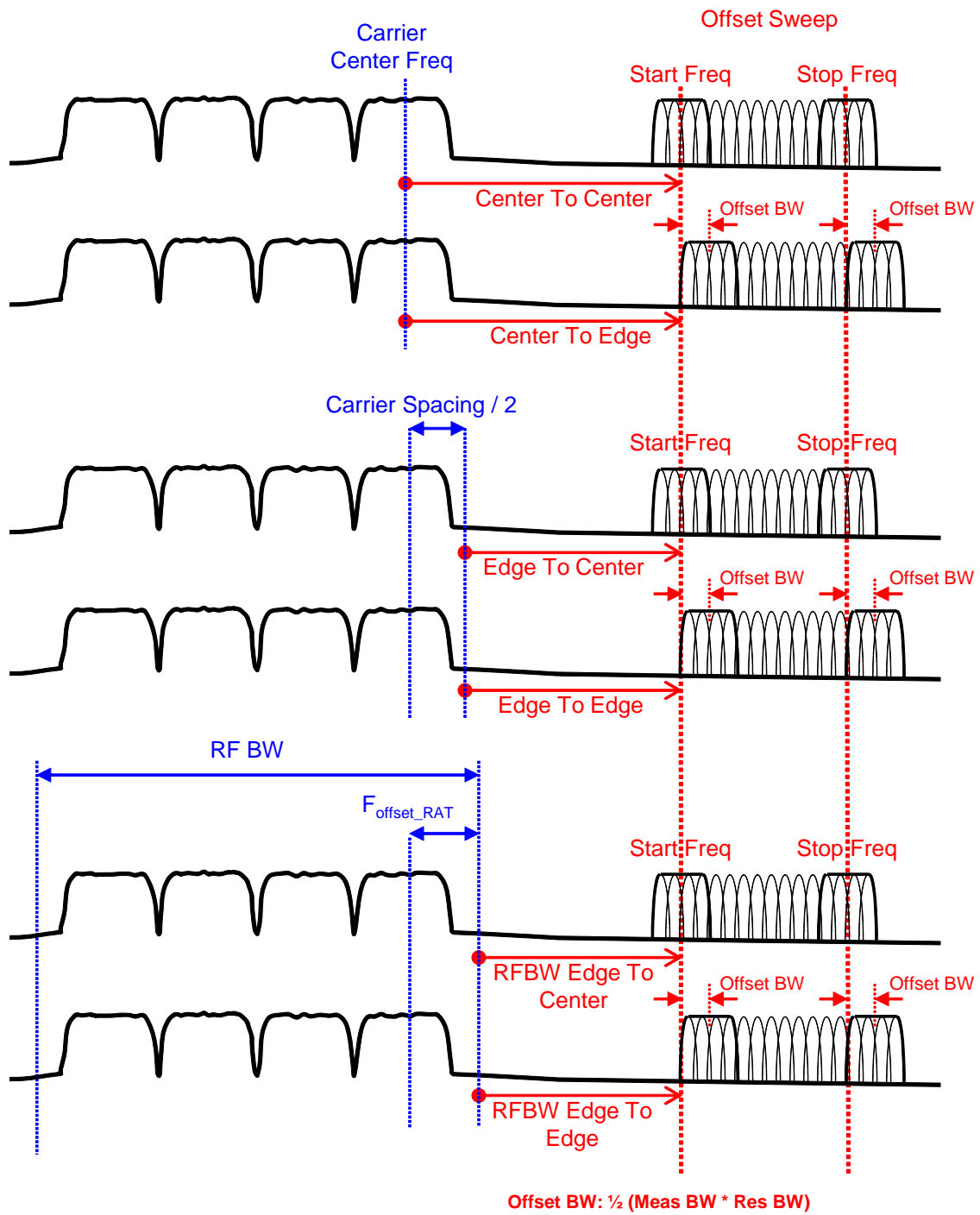

The figure above shows Offset Freq Definition in SEM measurement

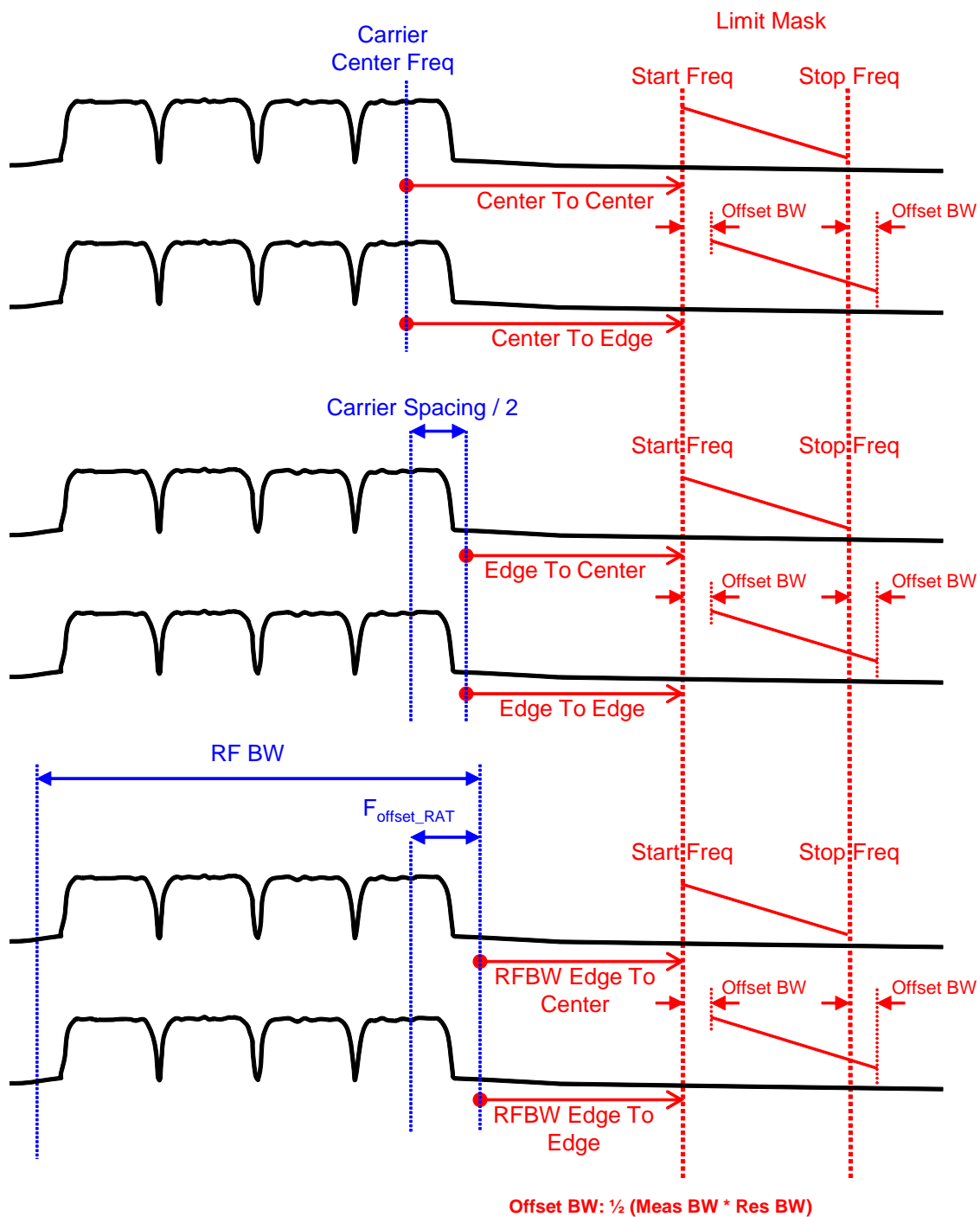

The figure above shows Offset Freq Definition (Limit Mask) in SEM measurement

Key Path	Meas Setup, Offset/Limits
Mode	MSR

Spectrum Emission Mask Measurement
Meas Setup

Remote Command	[:SENSe] :SEMAsk:OFFSet [1] 2 :TYPE CTOC CTOE ETOC ETOE RTOC RTOE [:SENSe] :SEMAsk:OFFSet [1] 2 :TYPE?
Example	SEM:OFFS:TYPE ETOC SEM:OFFS:TYPE?
Notes	You must be in the MSR mode to use this command. Use :INSTrument:SElect to set the mode. For other modes, see “Offset Freq Define” on page 792 .
Preset	RTOE
State Saved	Saved in instrument state.
Range	Carrier Center To Meas BW Center Carrier Center To Meas BW Edge Carrier Edge To Meas BW Center Carrier Edge To Meas BW Edge RFBW Edge To Meas BW Center RFBW Edge To Meas BW Edge
Readback	Center to Center Center to Edge Edge to Center Edge to Edge R Edge to Center R Edge to Edge
Backwards Compatibility SCPI	[:SENSe] :SEMAsk:OFFSet [1] 2 :TYPE CTOCenter CTOEdge ETOCenter ETOEdge
Initial S/W Revision	A.10.01

Mode

See “Mode” on page 1534 for more information.

Key Path	Front-panel key
Initial S/W Revision	Prior to A.02.00

Mode Setup

See “[Mode Setup](#)” on page 1553 for more information.

Key Path	Front-panel key
Initial S/W Revision	Prior to A.02.00

Peak Search

There is no 'Peak Search' supported in Spectrum Emission Mask so this front-panel key will display a blank key menu when pressed.

Key Path	Front-panel key
Initial S/W Revision	Prior to A.02.00

Recall

See “[Recall](#)” on page 194 for more information.

Key Path	Front-panel key
Initial S/W Revision	Prior to A.02.00

Restart

See “Restart” on page 1558 for more information.

Key Path	Front-panel key
Initial S/W Revision	Prior to A.02.00

Save

See “[Save](#)” on page 207 for more information.

Key Path	Front-panel key
Initial S/W Revision	Prior to A.02.00

Single

See “[Single \(Single Measurement/Sweep\)](#)” on page 1563 for more information.

Key Path	Front-panel key
Initial S/W Revision	Prior to A.02.00

Source

Operation of this key is identical across all measurements. For details about this key, see [“Source” on page 1564](#).

Key Path	Front-panel key
----------	------------------------

Span X Scale

Span X Scale functionality is not supported in Spectrum Emission Mask, so this front-panel key will display a blank key menu when pressed.

Key Path	Front-panel key
Initial S/W Revision	Prior to A.02.00

Sweep/Control

Displays a menu that enables you to set up and control the sweep time, gate method, and source of the current measurement. See [“Sweep/Control” on page 1564](#) for more information.

Key Path	Front-panel key
Initial S/W Revision	Prior to A.02.00

Pause

Pauses a measurement after the current data acquisition is complete. When Paused, the label on the key changes to Resume. Pressing the Resume key resumes the measurement at the point it was at when paused. See [“Pause/Resume” on page 1577](#) for more details.

Key Path	Sweep/Control
Initial S/W Revision	Prior to A.02.00

Gate

Accesses a menu that enables you to control the gating function .

The Gate functionality is used to view signals best viewed by qualifying them with other events. See [“Gate ” on page 1578](#) for more details.

Key Path	Sweep/Control
Initial S/W Revision	Prior to A.02.00

Trace/Detector

Accesses a menu of functions that enable you to control trace and detector for the current measurement.

Key Path	Front-panel key
Initial S/W Revision	Prior to A.02.00

Trace Type

Allows you to select the type of trace for the current measurement. The menu contains a 1-of-N selection of the trace type (Clear Write, Average, Max Hold, Min Hold).

Key Path	Trace/Detector
Mode	SA, WCDMA, C2K, WIMAX OFDMA, TD-SCDMA, 1xEVDO, DTMB (CTTB), DVB-T/H, ISDB-T, CMMB, LTE, LTETDD, Digital Cable TV, WLAN, MSR
Remote Command	:TRACe:SEMask:TYPE WRITe AVERAge MAXHold MINHold :TRACe:SEMask:TYPE?
Example	TRAC:SEM:TYPE MINH TRAC:SEM:TYPE?
Notes	WRITe = Clear Write AVERAge = Average MAXHold = Maximum Hold MINHold = Minimum Hold
Couplings	When Detector setting is “Auto” ([:SENSe]:SEMask:DETEctor:AUTO?), Detector ([:SENSe]:SEMask:DETEctor[:FUNction]?) switches aligning with the switch of this parameter: “NORMal” with WRITe (Clear Write), “AVERAge” with AVERAge, “POSitive (peak)” with MAXHold, and “NEGative (peak)” with MINHold.
Preset	AVERAge
State Saved	Saved in instrument state.
Range	WRITe AVERAge MAXHold MINHold
Initial S/W Revision	Prior to A.02.00
Modified at S/W Revision	A.02.00, A.03.00

Chan Detector

Accesses a menu of functions that enable you to control the detectors for reference channel. The following choices are available:

Spectrum Emission Mask Measurement Trace/Detector

- Auto- the detector selected depends on marker functions, trace functions, average type, and the trace averaging function.
- Normal-the detector determines the peak of the CW-like signals, and it yields alternating maximums and minimums of noise-like signals. This is also referred to as Rosenfell detection.
- Average-the detector determines the average of the signal within the sweep points. The averaging method depends upon the Average Type selection (voltage, power or log scales).
- Peak-the detector determines the maximum of the signal within the sweep points.
- Sample-the detector indicates the instantaneous level of the signal at the center of the sweep points represented by each display point.
- Negative Peak-the detector determines the minimum of the signal within the sweep points.

Key Path	Trace/Detector
Initial S/W Revision	Prior to A.02.00

Chan Detector Selection

Selects the detector mode for the reference channel.

Key Path	Trace/Detector
Mode	SA, WCDMA, C2K, WIMAX OFDMA, TD-SCDMA, 1xEVDO, DTMB (CTTB), DVB-T/H, ISDB-T, CMMB, LTE, LTETDD, Digital Cable TV, WLAN, MSR
Remote Command	[:SENSe] :SEMAsk:DETEctor:CARRier[:FUNctIon] AVERAge NEGAtive NORMAl POSitive SAMPlE [:SENSe] :SEMAsk:DETEctor:CARRier[:FUNctIon]?
Example	SEM:DET:CARR NEG SEM:DET:CARR?
Notes	When you manually select a detector (instead of selecting Auto), that detector is used regardless of other analyzer settings. This detector setting affects the reference channel. There is not a per trace detector. You must be in the mode that includes SEM measurement to use this command. Use :INSTrument:SELEct to set the mode.
Couplings	See Couplings in the Trace Type section.
Preset	AVERAge
State Saved	Saved in instrument state.
Range	Normal Average Peak Sample Negative Peak
Initial S/W Revision	Prior to A.02.00
Modified at S/W Revision	A.02.00, A.03.00

Chan Detector Auto

Sets the detector to the default detection mode for the reference channel. This mode is dependent upon the current reference channel conditions.

Key Path	Trace/Detector
Mode	SA, WCDMA, C2K, WIMAX OFDMA, TD-SCDMA, 1xEVDO, DTMB (CTTB), DVB-T/H, ISDB-T, CMMB, LTE, LTETDD, Digital Cable TV, WLAN, MSR
Remote Command	[:SENSe] :SEMAsk :DETEctor :CARRier :AUTO ON OFF 1 0 [:SENSe] :SEMAsk :DETEctor :CARRier :AUTO?
Example	SEM:DET:CARR:AUTO OFF SEM:DET:CARR:AUTO?
Notes	See Couplings in the Trace Type section. You must be in the mode that includes SEM measurement to use this command. Use :INSTrument:SELEct to set the mode.
Preset	ON
State Saved	Saved in instrument state
Range	On Off
Initial S/W Revision	Prior to A.02.00
Modified at S/W Revision	A.02.00, A.03.00

Offset Detector

Accesses a menu of functions that enable you to control the detector for offsets. The following choices are available.

- Auto- the detector selected depends on marker functions, trace functions, average type, and the trace averaging function.
- Normal-the detector determines the peak of the CW-like signals, and it yields alternating maximums and minimums of noise-like signals. This is also referred to as Rosenfell detection.
- Average-the detector determines the average of the signal within the sweep points. The averaging method depends upon the Average Type selection (voltage, power or log scales).
- Peak-the detector determines the maximum of the signal within the sweep points.
- Sample-the detector indicates the instantaneous level of the signal at the center of the sweep points represented by each display point.
- Negative Peak-the detector determines the minimum of the signal within the sweep points.

Key Path	Trace/Detector
Initial S/W Revision	Prior to A.02.00

Offset Detector Selection

Selects the detector mode for the offsets.

Key Path	Trace/Detector
Mode	SA, WCDMA, C2K, WIMAX OFDMA, TD-SCDMA, 1xEVDO, DTMB (CTTB), DVB-T/H, ISDB-T, CMMB, LTE, LTETDD, Digital Cable TV, WLAN, MSR
Remote Command	[:SENSe] :SEMAsk:DETEctor:OFFSet [:FUNction] AVERAge NEGAtive NORMAl POSitive SAMPlE [:SENSe] :SEMAsk:DETEctor:OFFSet [:FUNction] ?
Example	SEM:DET:OFFS AVER SEM:DET:OFFS?
Notes	When you manually select a detector (instead of selecting Auto), that detector is used regardless of other analyzer settings. This detector setting has effects all offsets. There is not a per trace detector. You must be in the mode that includes SEM measurement to use this command. Use :INSTrument:SELect to set the mode.
Couplings	See Couplings in the Trace Type section.
Preset	POSitive
State Saved	Saved in instrument state.
Range	Normal Average Peak Sample Negative Peak
Initial S/W Revision	Prior to A.02.00
Modified at S/W Revision	A.02.00, A.03.00

Offset Detector Auto

Sets the detector to the default detection mode for the offsets. This mode is dependent upon the current signal conditions of the offsets.

Key Path	Trace/Detector
Mode	SA, WCDMA, C2K, WIMAX OFDMA, TD-SCDMA, 1xEVDO, DTMB (CTTB), DVB-T/H, ISDB-T, CMMB, LTE, LTETDD, Digital Cable TV, WLAN, MSR
Remote Command	[:SENSe] :SEMAsk:DETEctor:OFFSet:AUTO ON OFF 1 0 [:SENSe] :SEMAsk:DETEctor:OFFSet:AUTO?
Example	SEM:DET:OFFS:AUTO OFF SEM:DET:OFFS:AUTO?

Notes	See Couplings in the Trace Type section. You must be in the mode that includes SEM measurement to use this command. Use :INSTrument:SElect to set the mode.
Preset	ON
State Saved	Saved in instrument state.
Range	On Off
Initial S/W Revision	Prior to A.02.00
Modified at S/W Revision	A.02.00, A.03.00

Trigger

Accesses a menu that enables you to select and control the trigger source for the current measurement.

See [“Trigger” on page 1595](#) for more information.

Key Path	Front-panel key
Initial S/W Revision	Prior to A.02.00

View/Display

Accesses a menu of functions that enable you to control the instrument display.

The following keys select how the results are displayed:

- Abs Pwr Freq-displays the absolute power levels in dBm and the corresponding frequencies in the text window.
- Rel Pwr Freq-displays the relative power levels in dBc and the corresponding frequencies in the text window.
- Integrated Power-displays the absolute and relative power levels integrated throughout the bandwidths between the start and stop frequencies in the text window.
- Carrier Info -displays the carrier configuration information with measure powers. (Only available in MSR)

[“View Selection by Name \(Remote Command Only\)” on page 816](#)

[“Views Selection by Number \(Remote Command only\)” on page 816](#)

View Selection by Name (Remote Command Only)

Key Path	View/Display
Mode	SA, WCDMA, C2K, WIMAX OFDMA, TD-SCDMA, 1xEVDO, DTMB (CTTB), DVB-T/H, ISDB-T, CMMB, LTE, LTETDD, Digital Cable TV, WLAN, MSR
Remote Command	:DISPlay:SEMask:VIEW[:SElect] APFReq RPFReq IPOWER CINformation :DISPlay:SEMask:VIEW[:SElect]?
Example	DISP:SEM:VIEW IPOW DISP:SEM:VIEW?
Notes	You must be in the mode that includes SEM measurement to use this command. Use :INSTrument:SElect to set the mode.
Dependencies	In the SA mode, when "Radio Standard" is set to WLAN, IPOwer is not available and the key is grayed out. CINformation is available only in MSR and the key is blank if not in MSR.
Preset	SA, WCDMA, C2K, TD-SCDMA, 1xEVDO, DTMB (CTTB), DVB-T/H, ISDB-T, CMMB, LTE, LTETDD, Digital Cable TV, MSR: APFReq WIMAX OFDMA, WLAN: RPFReq
State Saved	Saved in instrument state.
Range	Abs Pwr & Freq Rel Pwr & Freq Integrated Power Carrier Info
Initial S/W Revision	Prior to A.02.00
Modified at S/W Revision	A.02.00, A.03.00, A.10.01

Views Selection by Number (Remote Command only)

The following numerical selections select how the results are displayed:

1. displays the absolute power levels in dBm and the corresponding frequencies in the text window.
2. displays the relative power levels in dBc and the corresponding frequencies in the text window.
3. displays the absolute and relative power levels integrated throughout the bandwidths between the start and stop frequencies in the text window.
4. displays the carrier info table. (Only available in MSR)

Mode	SA, WCDMA, C2K, WIMAX OFDMA, TD-SCDMA, 1xEVDO, DTMB (CTTB), DVB-T/H, ISDB-T, CMMB, LTE, LTETDD, Digital Cable TV, WLAN, MSR
Remote Command	:DISPlay:SEMask:VIEW:NSElect <integer> :DISPlay:SEMask:VIEW:NSElect?

Example	DISP:SEM:VIEW:NSEL 2 DISP:SEM:VIEW:NSEL?
Notes	In the SA mode, when "Radio Standard" is set to WLAN, 3 is not available. Only in MSR mode 4 is available. You must be in the mode that includes SEM measurement to use this command. Use :INSTrument:SElect to set the mode.
Preset	SA, WCDMA, C2K, TD-SCDMA, 1xEVDO, DTMB (CTTB), DVB-T/H, ISDB-T, CMMB, LTE, LTETDD, Digital Cable TV, MSR: 1 WIMAX OFDMA, WLAN: 2
State Saved	Saved in instrument state.
Min	1
Max	MSR: 4 Other modes: 3
Initial S/W Revision	Prior to A.02.00
Modified at S/W Revision	A.02.00, A.03.00, A.10.01

Key Path	Front-panel key
Initial S/W Revision	Prior to A.02.00

Display

Accesses a menu of functions that enable you to set the display parameters.

See [“Display” on page 1646](#) for more information.

Key Path	View/Display
Initial S/W Revision	Prior to A.02.00

Abs Pwr Freq

Sets the display to the Absolute Peak Power and Frequency view. The views differ depending on the setting of the measurement type (Meas Type) under the Measurement Setup menu.

[“Abs Peak Pwr & Freq \(Total Pwr Ref\)” on page 817](#)

[“Abs Peak Pwr & Freq \(PSD Ref\)” on page 820](#)

[“Abs Peak Pwr & Freq \(Spectrum Pk Ref\)” on page 823](#)

Abs Peak Pwr & Freq (Total Pwr Ref)

This view consists of the following two windows:

[“Trace Window” on page 820](#)

Spectrum Emission Mask Measurement
View/Display

“Results Window ” on page 820

The figure below shows Abs Peak Pwr & Freq View (Total Pwr Ref) for non-MSR mode.

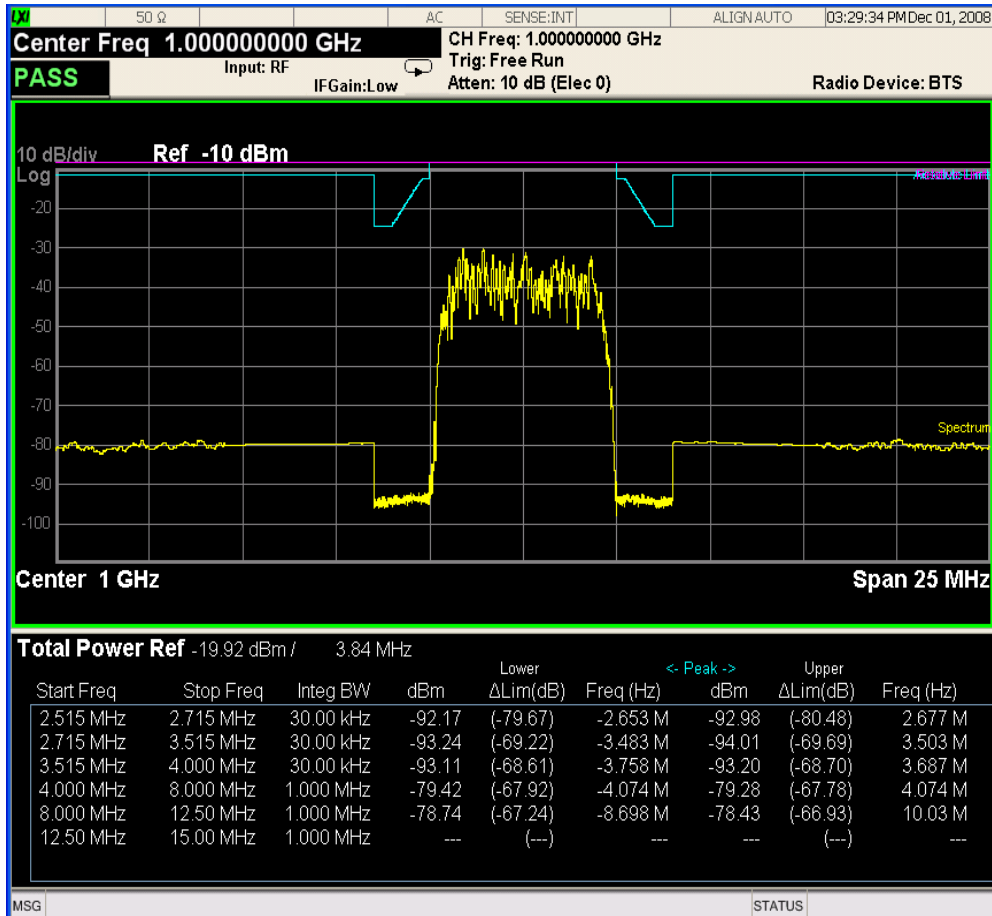

The figure below shows Abs Peak Pwr & Freq View (Total Pwr Ref) for MSR mode only.

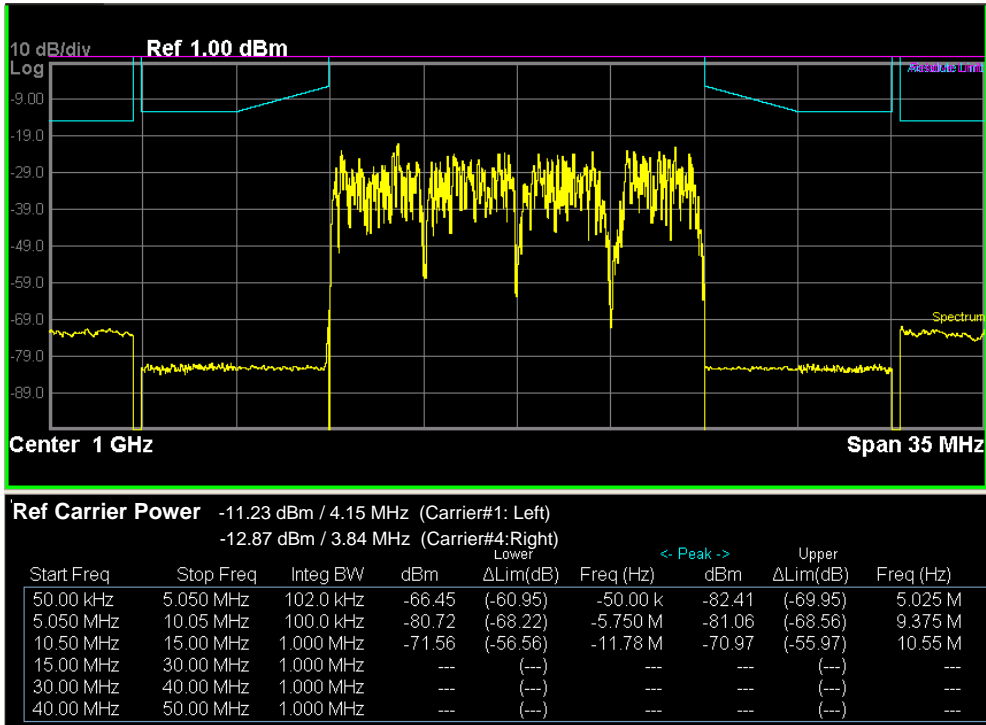

Trace Window

Corresponding Trace	yellow - Combined trace from carrier and each offset
---------------------	--

Results Window

Name	Corresponding Results
Total Pwr Ref	n=1 2nd element Absolute power at the reference area.
	Channel Integration Bandwidth
Start (Hz)	Start frequency for offset
Stop (Hz)	Stop frequency for offset
Meas BW (Hz)	Measurement bandwidth for offset
Lower Peak (dBm)	Absolute peak power on minimum margin point of the negative offset
Lower lim (dB)	Minimum margin from limit line which is decided by Fail Mask setting on the negative offset
Lower Freq (Hz)	Frequency on minimum margin point of the negative offset
Upper Peak (dBm)	Absolute peak power on minimum margin point of the positive offset
Upper lim (dB)	Minimum margin from limit line which is decided by Fail Mask setting on the positive offset
Upper Freq (Hz)	Frequency on minimum margin point of the positive offset

Abs Peak Pwr & Freq (PSD Ref)

This view consists of the following two windows:

“Trace Window” on page 823

“Results Window ” on page 823

The figure below shows Abs Peak Pwr & Freq View (PSD Ref) for non-MSR mode.

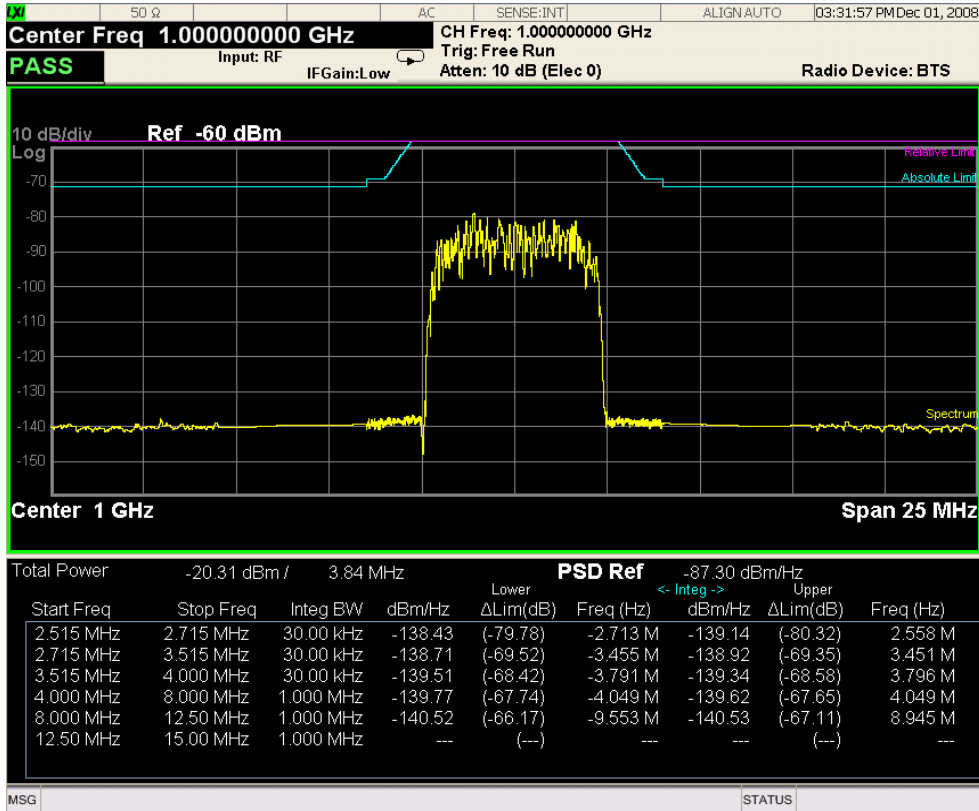

The figure below shows Abs Peak Pwr & Freq View (PSD Ref) for MSR mode only.

Spectrum Emission Mask Measurement
View/Display

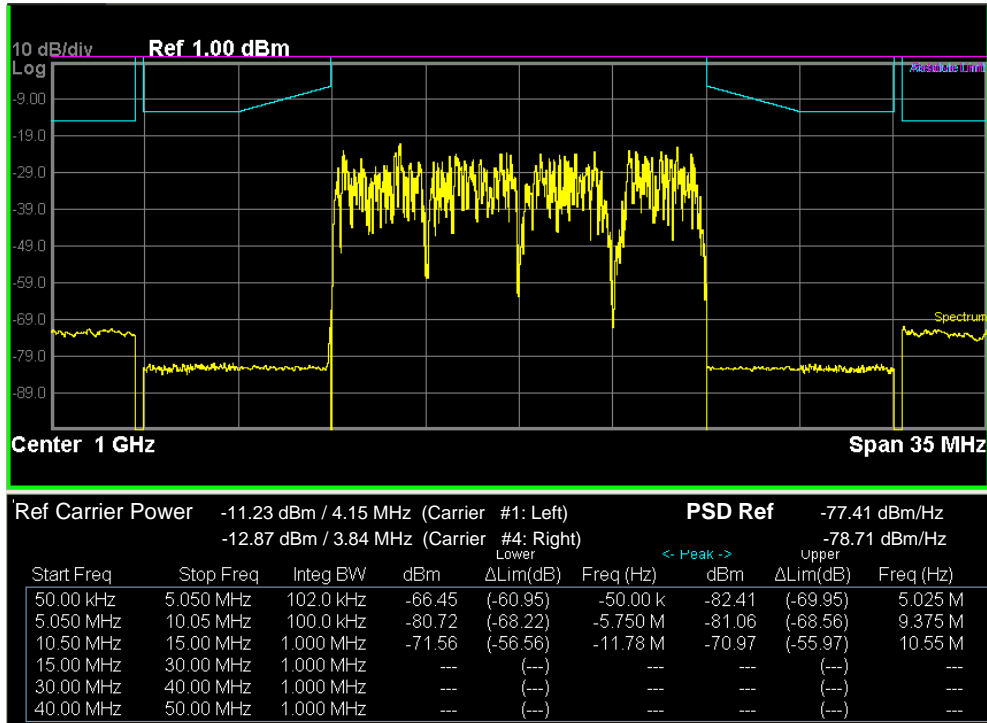

Trace Window

Corresponding Trace	yellow - Combined trace from carrier and each offset
---------------------	--

Results Window

Name	Corresponding Results
Total Pwr	n=1 2nd element Absolute power at the reference area.
	Channel Integration Bandwidth
PSD Ref	n=5 1st element Power spectral density reference at the reference area
Start (Hz)	Start frequency for offset
Stop (Hz)	Stop frequency for offset
Meas BW (Hz)	Measurement bandwidth for offset
Lower (dBm/Hz)	Absolute power spectrum density of the negative offset
Lower lim (dB)	Minimum margin from limit line which is decided by Fail Mask setting on the negative offset
Lower Freq (Hz)	Frequency on minimum margin point of the negative offset
Upper (dBm/Hz)	Absolute power spectrum density of the positive offset
Upper lim (dB)	Minimum margin from limit line which is decided by Fail Mask setting on the positive offset
Upper Freq (Hz)	Frequency on minimum margin point of the positive offset

Abs Peak Pwr & Freq (Spectrum Pk Ref)

This view consists of the following two windows:

[“Trace Window” on page 823](#)

[“Results Window ” on page 823](#)

The figure below shows Abs Peak Pwr & Freq View (Spectrum Pk Ref) for non-MSR mode.

Spectrum Emission Mask Measurement
View/Display

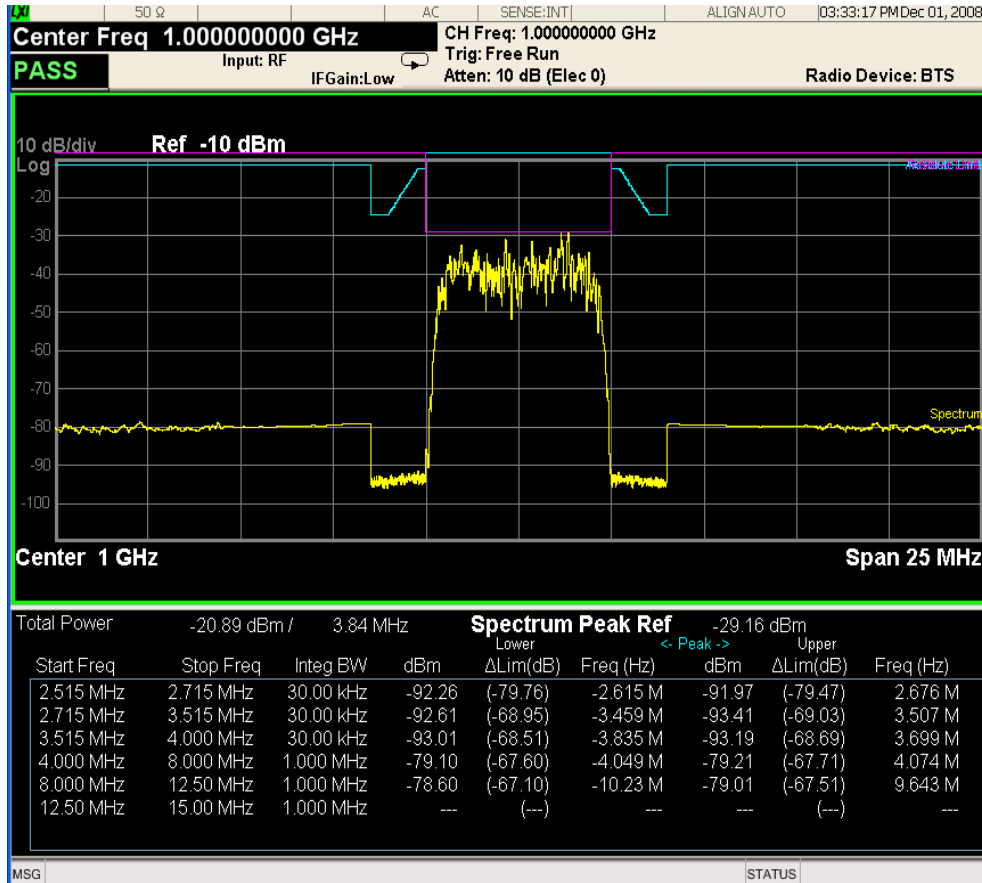

The figure below shows Abs Peak Pwr & Freq View (Spectrum Pk Ref) for MSR mode only.

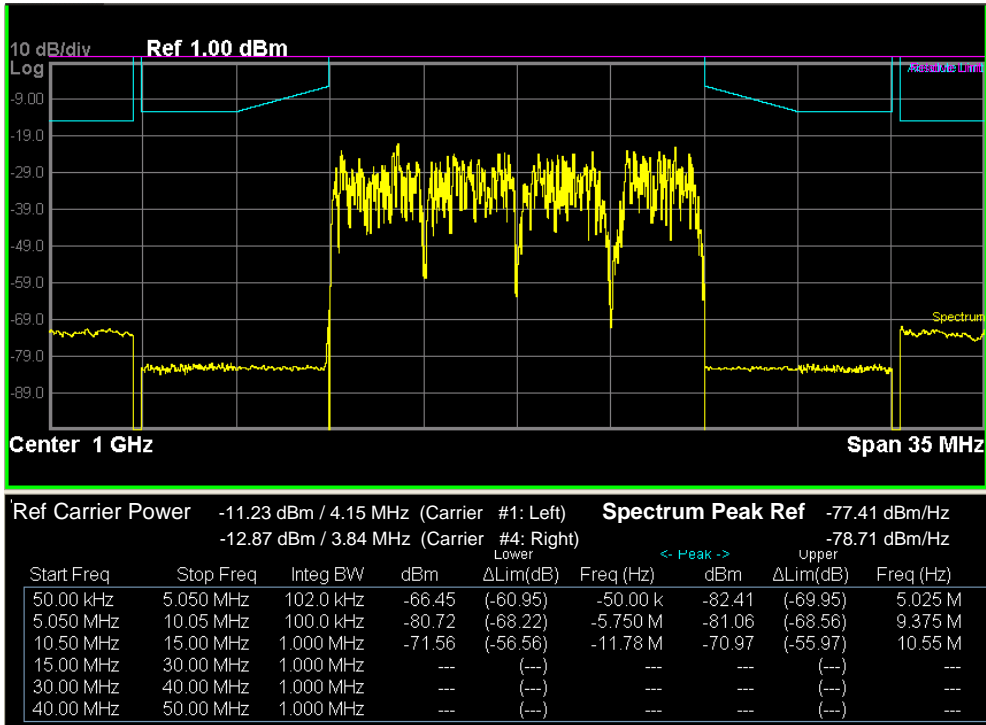

Trace Window

Corresponding Trace	yellow - Combined trace from carrier and each offset
---------------------	--

Results Window

Name	Corresponding Results
Total Pwr	Absolute power at the reference area.
	Channel Integration Bandwidth
Spectrum Peak Ref	n=5 1st element Spectrum peak power reference at the reference area
Start (Hz)	Start frequency for offset
Stop (Hz)	Stop frequency for offset
Meas BW (Hz)	Measurement bandwidth for offset
Lower(dBm)	Absolute peak power on minimum margin point of the negative offset
Lower lim (dB)	Minimum margin from limit line which is decided by Fail Mask setting on the negative offset
Lower Freq (Hz)	Frequency on minimum margin point of the negative offset
Upper (dBm)	Absolute peak power on minimum margin point of the positive offset
Upper lim (dB)	Minimum margin from limit line which is decided by Fail Mask setting on the positive offset
Upper Freq (Hz)	Frequency on minimum margin point of the positive offset

Key Path	View/Display
Initial S/W Revision	Prior to A.02.00

Rel Pwr Freq

Sets the display to the Relative Peak Power and Frequency view. The views differ depending on the setting of the measurement type (Meas Type) under the Measurement Setup menu.

[“Rel Peak Pwr & Freq \(Total Pwr Ref\)” on page 826](#)

[“Rel Peak Pwr & Freq \(PSD Ref\)” on page 828](#)

[“Rel Peak Pwr & Freq \(Spectrum Pk Ref\)” on page 830](#)

Rel Peak Pwr & Freq (Total Pwr Ref)

This view consists of the following two windows:

“Trace Window” on page 828

“Results Window” on page 828

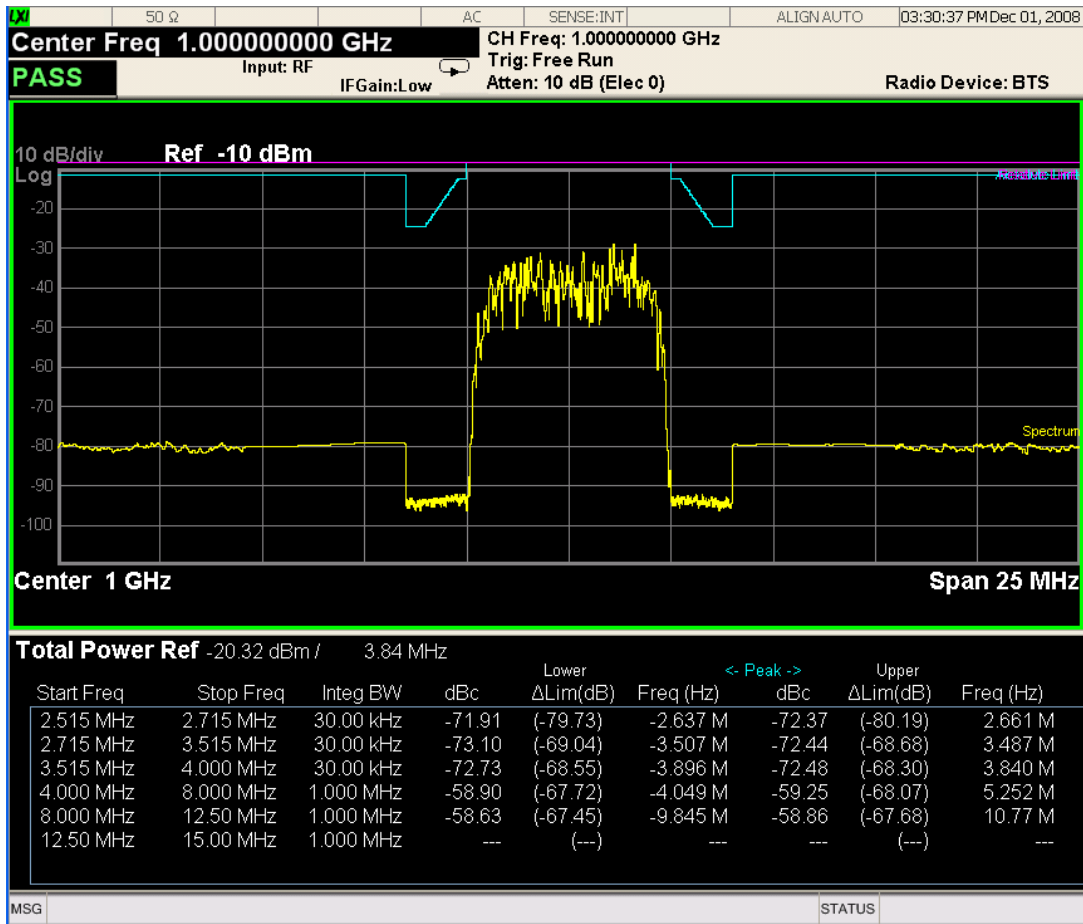

Trace Window

Corresponding Trace	yellow - Combined trace from carrier and each offset
---------------------	--

Results Window

Name	Corresponding Results
Total Pwr Ref	n=1 2nd element Absolute power at the reference area.
	Channel Integration Bandwidth
Start (Hz)	Start frequency for offset
Stop (Hz)	Stop frequency for offset
Meas BW (Hz)	Measurement bandwidth for offset
Lower Peak (dBc)	Relative peak power on minimum margin point of the negative offset
Lower Lim (dB)	Minimum margin from limit line which is decided by Fail Mask setting on the negative offset
Lower Freq (Hz)	Frequency on minimum margin point of the negative offset
Upper Peak (dBc)	Relative peak power on minimum margin point of the positive offset
Upper Lim (dB)	Minimum margin from limit line which is decided by Fail Mask setting on the positive offset
Upper Freq (Hz)	Frequency on minimum margin point of the positive offset

Rel Peak Pwr & Freq (PSD Ref)

This view consists of the following two windows:

[“Trace Window” on page 830](#)

[“Results Window” on page 830](#)

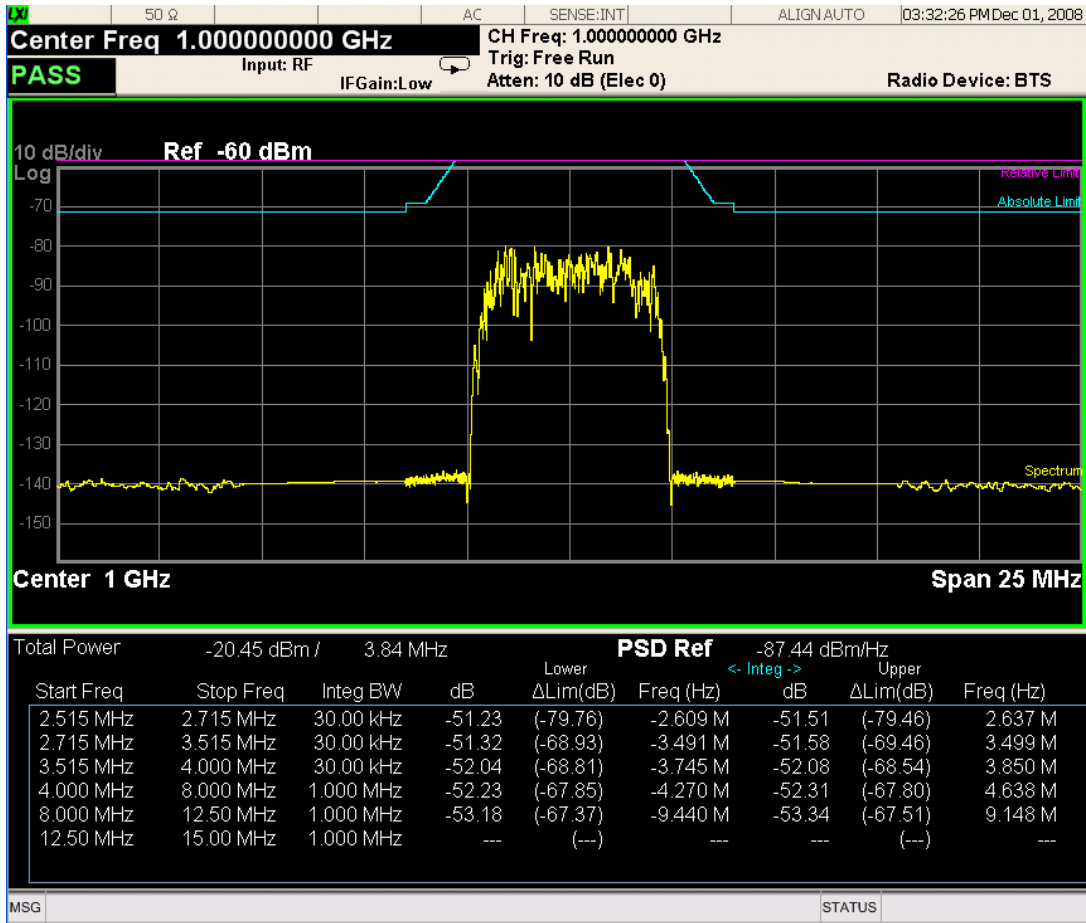

Trace Window

Corresponding Trace	yellow - Combined trace from carrier and each offset
---------------------	--

Results Window

Name	Corresponding Results
Total Pwr	n=1 2nd element Absolute power at the reference area.
	Channel Integration Bandwidth
PSD Ref	n=5 1st element Power spectral density reference at the reference area
Start (Hz)	Start frequency for offset
Stop (Hz)	Stop frequency for offset
Meas BW (Hz)	Measurement bandwidth for offset
Lower (dB)	Relative power spectrum density of the negative offset
Lower Lim (dB)	Minimum margin from limit line which is decided by Fail Mask setting on the negative offset
Lower Freq (Hz)	Frequency on minimum margin point of the negative offset
Upper (dB)	Relative power spectrum density of the positive offset
Upper Lim (dB)	Minimum margin from limit line which is decided by Fail Mask setting on the positive offset
Upper Freq (Hz)	Frequency on minimum margin point of the positive offset

Rel Peak Pwr & Freq (Spectrum Pk Ref)

This view consists of the following two windows:

“Trace Window” on page 828

“Results Window” on page 828

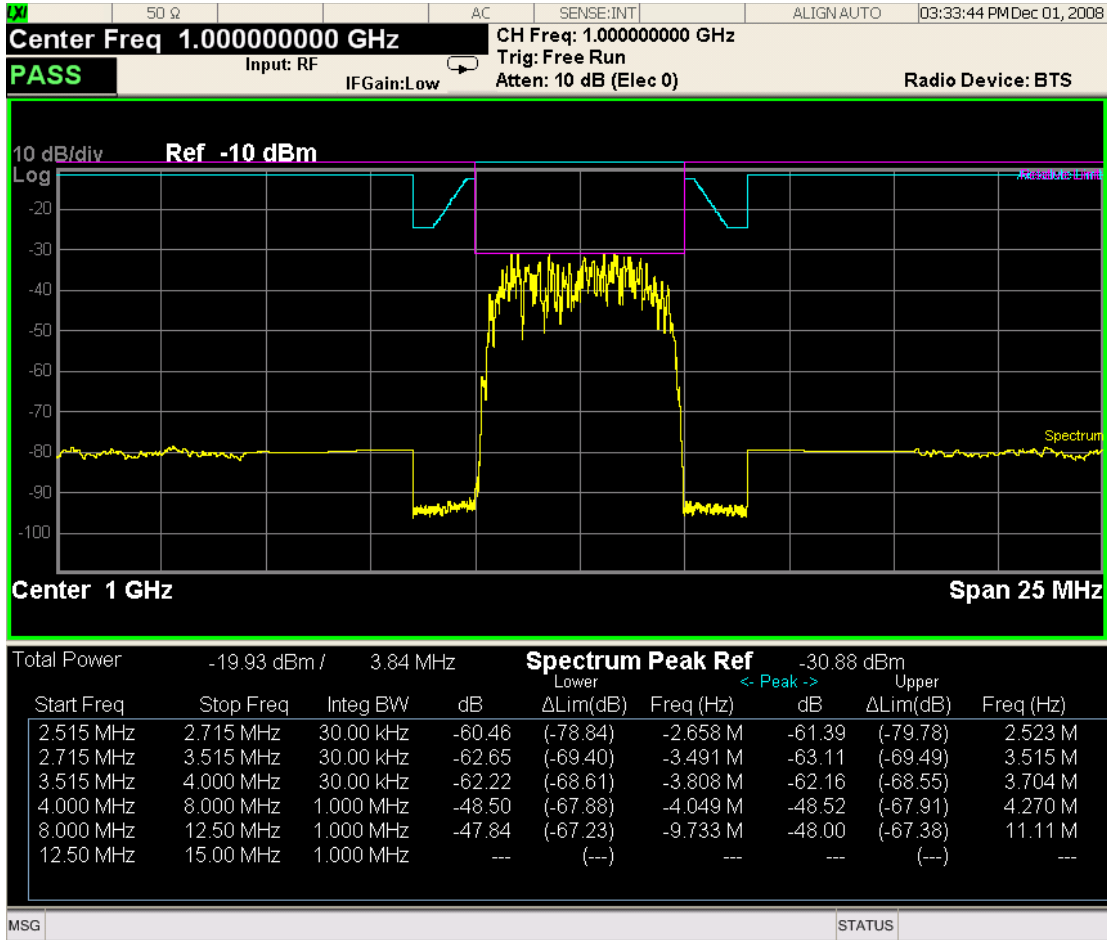

Trace Window

Corresponding Trace	yellow - Combined trace from carrier and each offset
---------------------	--

Results Window

Name	Corresponding Results
Total Pwr	Absolute power at the reference area.
	Channel Integration Bandwidth
Spectrum Peak Ref	n=5 1st element Spectrum peak power reference at the reference area
Start (Hz)	Start frequency for offset
Stop (Hz)	Stop frequency for offset
Meas BW (Hz)	Measurement bandwidth for offset
Lower Peak (dB)	Relative peak power on minimum margin point of the negative offset
Lower Lim (dB)	Minimum margin from limit line which is decided by Fail Mask setting on the negative offset
Lower Freq (Hz)	Frequency on minimum margin point of the negative offset
Upper Peak (dB)	Relative peak power on minimum margin point of the positive offset
Upper Lim (dB)	Minimum margin from limit line which is decided by Fail Mask setting on the positive offset
Upper Freq (Hz)	Frequency on minimum margin point of the positive offset

Key Path	View/Display
Initial S/W Revision	Prior to A.02.00

Integrated Power

Sets the display to the Integrated Power view. The views differ depending on the setting of the measurement type (Meas Type) under the Measurement Setup menu.

[“Integrated Power \(Total Pwr Ref\)” on page 832](#)

[“Integrated Power \(PSD Ref\)” on page 834](#)

[“Integrated Power \(Spectrum Pk Ref\)” on page 836](#)

Integrated Power (Total Pwr Ref)

[“Trace Window” on page 834](#)

“Results Window” on page 834

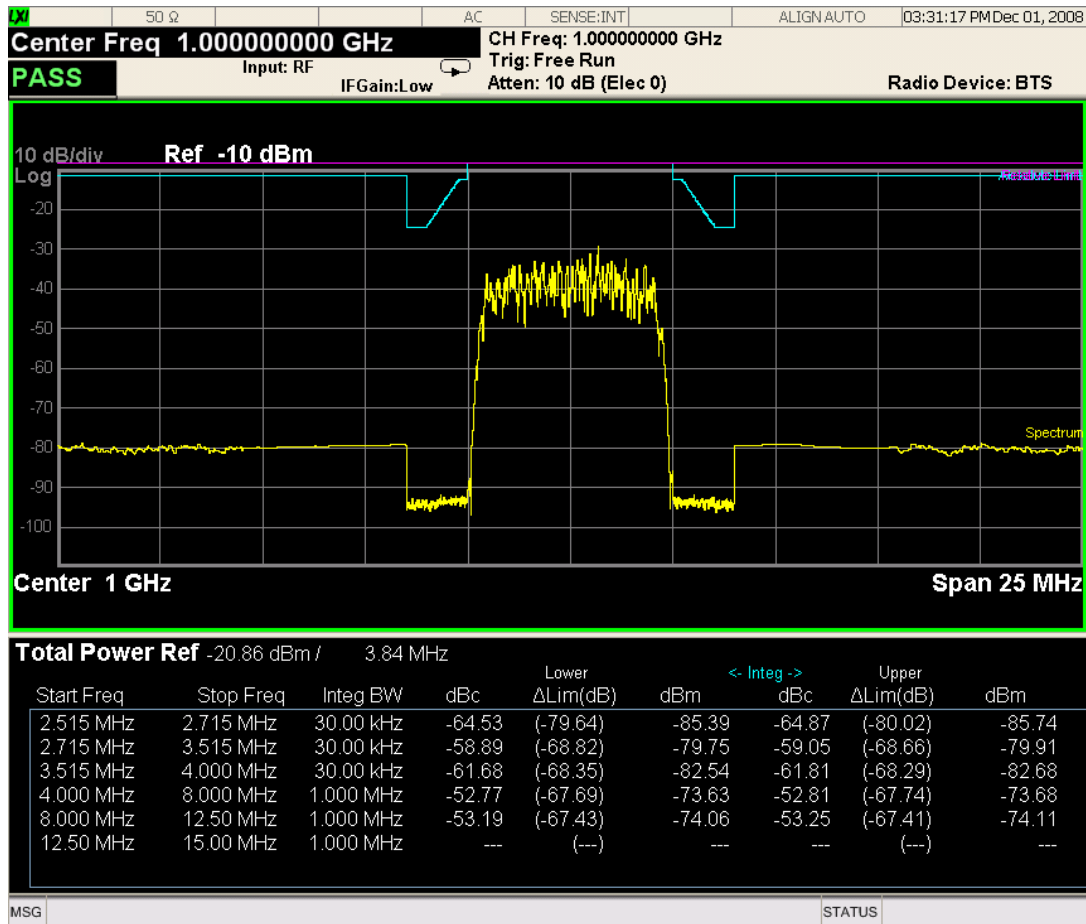

Trace Window

Corresponding Trace	yellow - Combined trace from carrier and each offset
---------------------	--

Results Window

Name	Corresponding Results
Total Pwr Ref	n=1 2nd element Absolute power at the reference area.
	Channel Integration Bandwidth
Start (Hz)	Start frequency for offset
Stop (Hz)	Stop frequency for offset
Meas BW (Hz)	Measurement bandwidth for offset
Lower Integ (dBc)	Relative integrated power on the negative offset
Lower Lim (dB)	Minimum margin from limit line which is decided by Fail Mask setting on the negative offset
Lower Integ (dBm)	Absolute integrated power on the negative offset
Upper Integ (dBc)	Relative integrated power on the positive offset
Upper Lim (dB)	Minimum margin from limit line which is decided by Fail Mask setting on the positive offset
Upper Integ (dBm)	Absolute integrated power on the positive offset

Integrated Power (PSD Ref)

“Trace Window” on page 836

“Results Window” on page 836

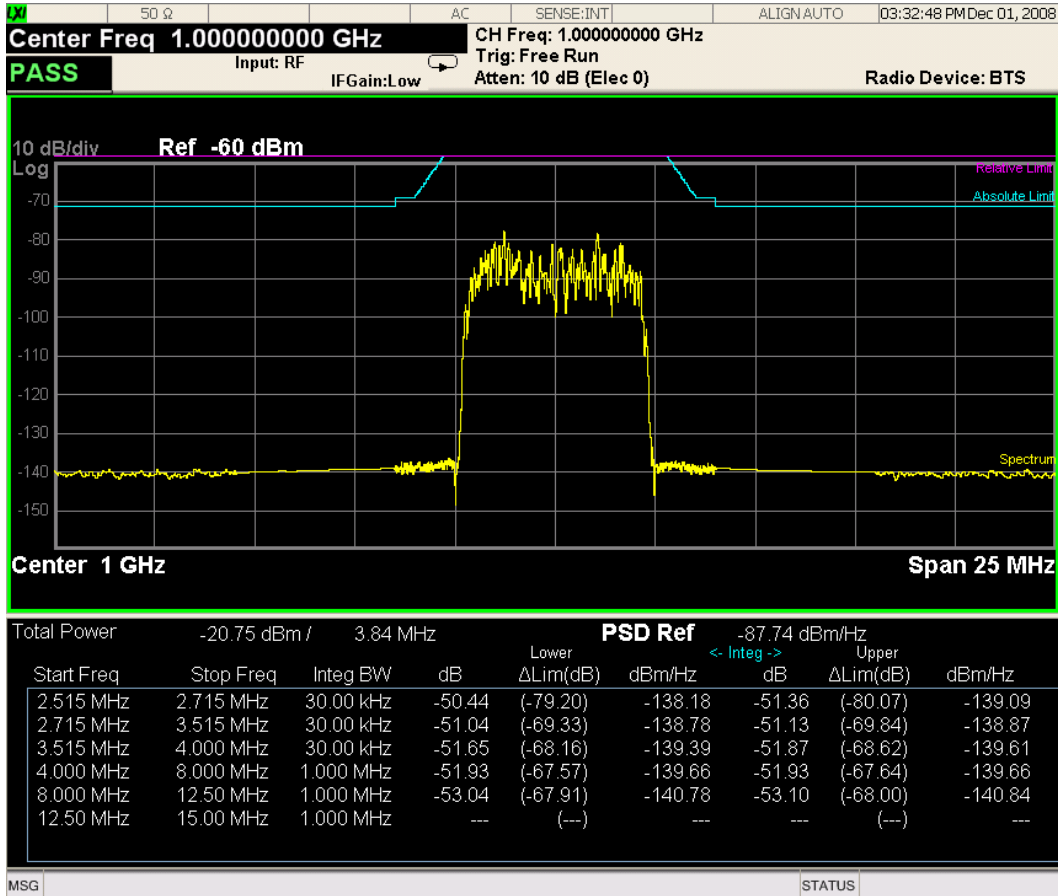

Trace Window

Corresponding Trace	yellow - Combined trace from carrier and each offset
---------------------	--

Results Window

Name	Corresponding Results
Total Pwr	n=1 2nd element Absolute power at the reference area.
	Channel Integration Bandwidth
PSD Ref	n=5 1st element Power spectral density reference at the reference area
Start (Hz)	Start frequency for offset
Stop (Hz)	Stop frequency for offset
Meas BW (Hz)	Measurement bandwidth for offset
Lower (dB)	Relative power spectrum density of the negative offset
Lower Lim (dB)	Minimum margin from limit line which is decided by Fail Mask setting on the negative offset
Lower (dBm/Hz)	Absolute power spectrum density of the negative offset
Upper (dB)	Relative power spectrum density of the positive offset
Upper Lim (dB)	Minimum margin from limit line which is decided by Fail Mask setting on the positive offset
Upper (dBm/Hz)	Absolute power spectrum density of the negative offset

Integrated Power (Spectrum Pk Ref)

[“Trace Window” on page 834](#)

[“Results Window” on page 834](#)

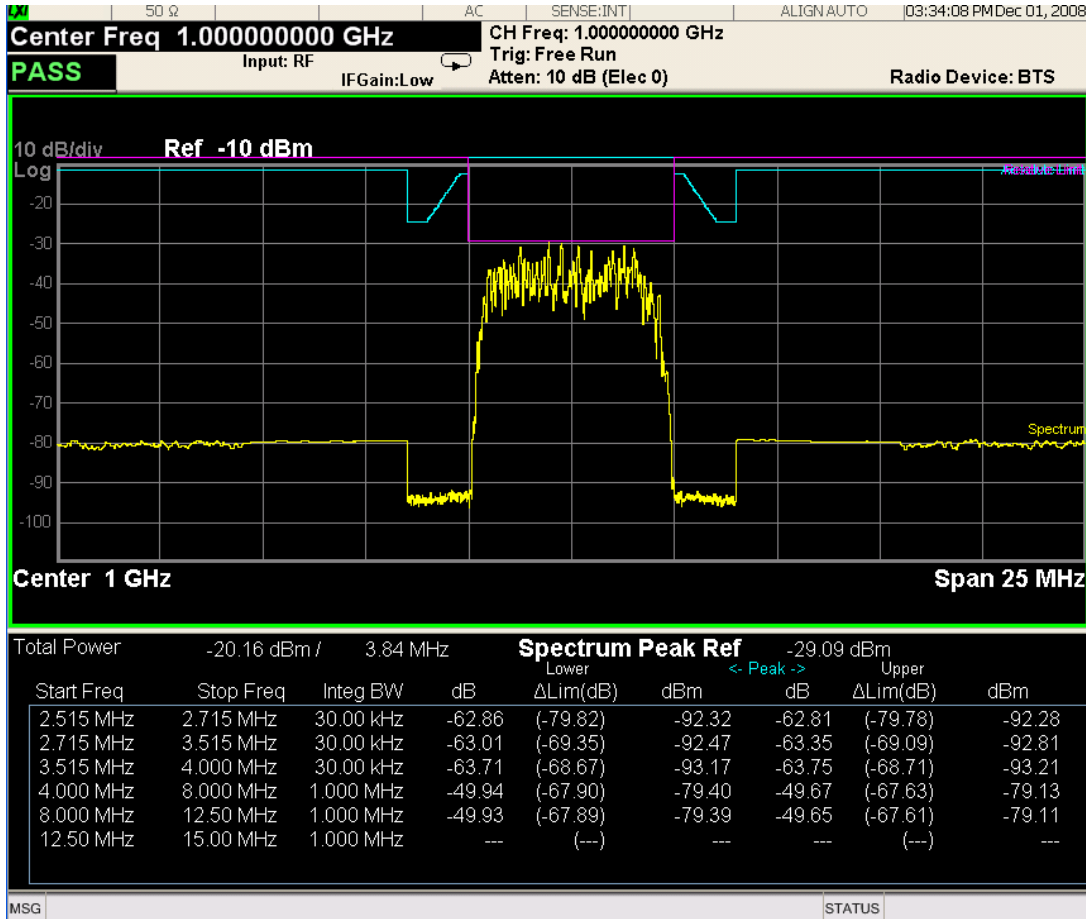

Trace Window

Corresponding Trace	yellow - Combined trace from carrier and each offset
---------------------	--

Results Window

Name	Corresponding Results
Total Pwr	Absolute power at the reference area.
	Channel Integration Bandwidth
Spectrum Peak Ref	n=5 1st element Peak power at the reference area
Start (Hz)	Start frequency for offset
Stop (Hz)	Stop frequency for offset
Meas BW (Hz)	Measurement bandwidth for offset
Lower Peak (dB)	Relative peak power on minimum margin point of the negative offset
Lower lim (dB)	Minimum margin from limit line which is decided by Fail Mask setting on the negative offset
Lower Peak (dBm)	Absolute peak power on minimum margin point of the negative offset
Upper Peak (dB)	Relative peak power on minimum margin point of the positive offset
Upper lim (dB)	Minimum margin from limit line which is decided by Fail Mask setting on the positive offset
Upper Peak (dBm)	Absolute peak power on minimum margin point of the positive offset

Key Path	View/Display
Initial S/W Revision	Prior to A.02.00

Carrier Info (MSR Only)

Sets the display to the Carrier Info view. The lower window is the carrier info table in this view.

Carrier center frequency can be displayed in either offset or absolute frequency depending on Carrier Freq. The table can be scrolled by Carrier Result on Meas Setup menu or by Select Carrier on Config Carriers menu. The highlighted row changes as either Carrier Result or Select Carrier is changed. The highlighted row and these keys are not coupled.

The figure below shows Carrier Info Table View (Total Power).

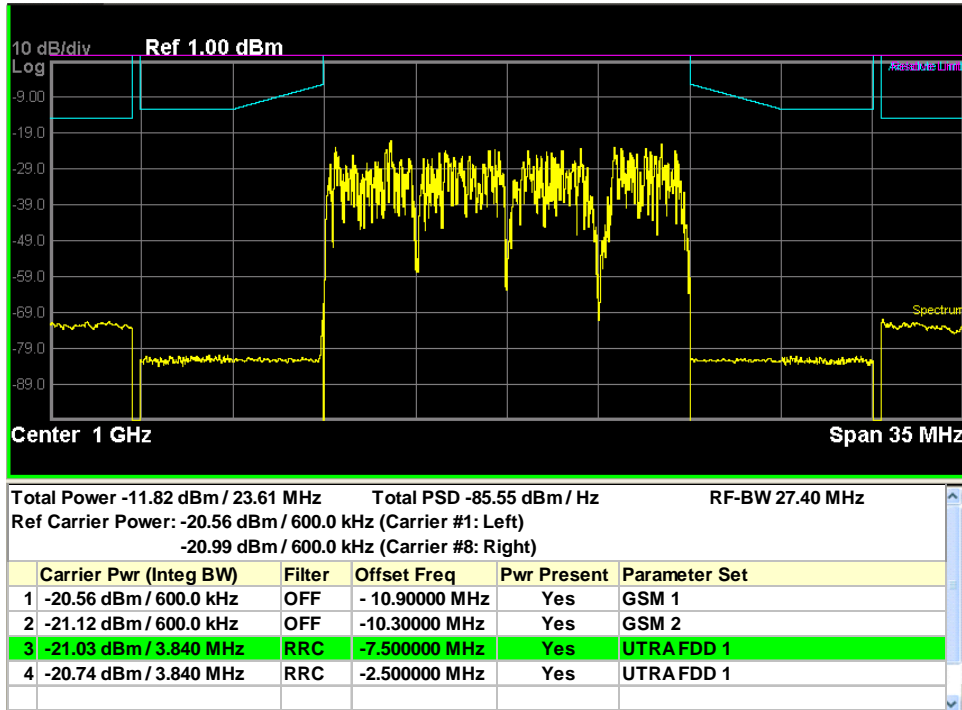

The figure below shows Carrier Info Table (PSD).

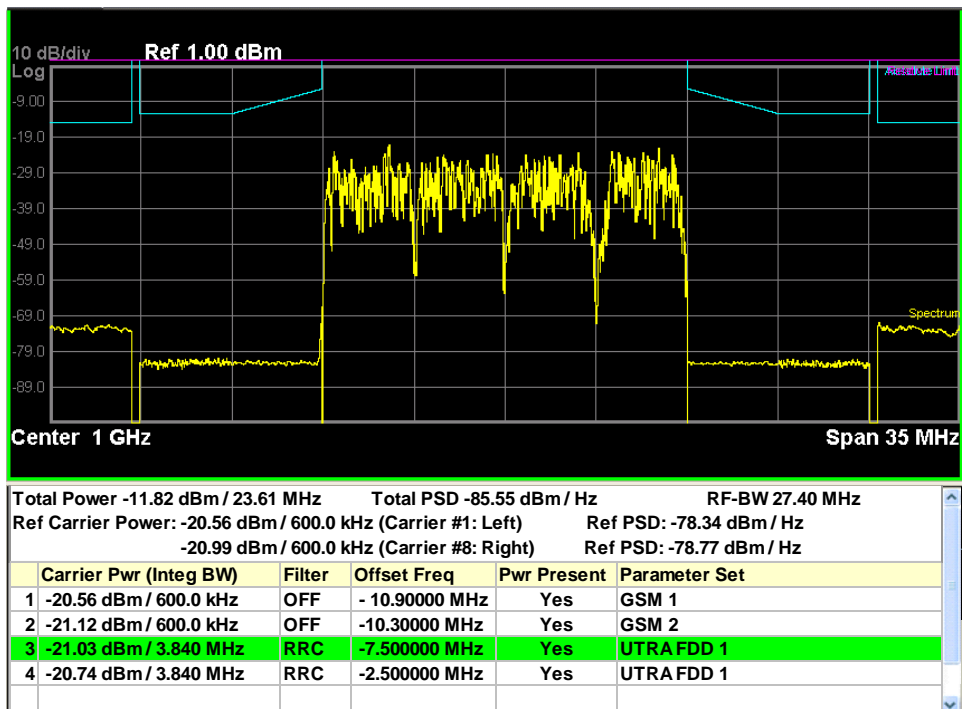

The figure below shows Carrier Info Table (Spectrum Pk).

Spectrum Emission Mask Measurement
View/Display

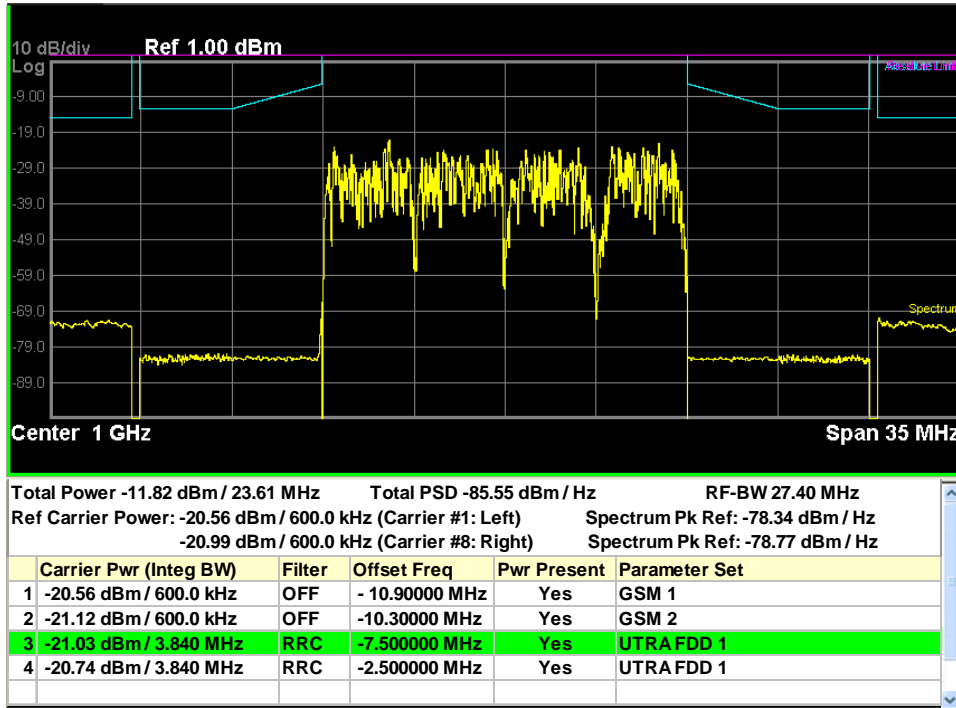

Key Path	View/Display
Initial S/W Revision	A.10.01

Carrier Freq (MSR Only)

Sets the carrier frequency display type.

Offset - The carrier center frequencies are displayed as offset from Carrier Ref Freq.

Absolute - The carrier center frequencies are displayed as absolute frequency.

Key Path	View/Display, Carrier Info
Mode	MSR
Remote Command	:DISPlay:SEMask:VIEW:WINDow:CINFormation:FREQuency OFFSet ABSolute :DISPlay:SEMask:VIEW:WINDow:CINFormation:FREQuency?
Example	DISP:SEM:VIEW:WIND:CINF:FREQ ABS DISP:SEM:VIEW:WIND:CINF:FREQ?
Preset	OFFSet
State Saved	Saved in instrument state
Range	Offset Absolute
Initial S/W Revision	A.10.01

Limit Lines

Toggles the limit lines display function for the spectrum emission mask measurements On and Off.

Key Path	View/Display
Mode	SA, WCDMA, C2K, WIMAX OFDMA, TD-SCDMA, 1xEVDO, DTMB (CTTB), DVB-T/H, ISDB-T, CMMB, LTE, LTETDD, Digital Cable TV, WLAN, MSR
Remote Command	:CALCulate:SEMask:LLINe:STATe ON OFF 1 0 :CALCulate:SEMask:LLINe:STATe?
Example	CALC:SEM:LLIN:STAT OFF CALC:SEM:LLIN:STAT?
Notes	You must be in the mode that includes SEM measurement to use this command. Use :INSTrument:SElect to set the mode.
Preset	ON
State Saved	Saved in instrument state.
Range	On Off
Initial S/W Revision	Prior to A.02.00
Modified at S/W Revision	A.02.00, A.03.00

For information on how to make measurement using the X-Series Signal Analyzer, see:

Measurement Guide [n9080-90006.pdf].

This section contains the following topics:

[“Description” on page 843](#)

[“Remote Commands” on page 843](#)

[“Remote SCPI Results” on page 843](#)

Description

The LTE modulation analysis measurement enables you to measure LTE signals according to 3GPP TS 36.211. The measurement supports all LTE bandwidths plus all modulation formats and sequences for both downlink (OFDMA) and uplink (SC-FDMA) analysis. Once you have configured the measurement you can use these commands to initiate the measurement and retrieve the measurement results.

All of the scalar results for this measurement are contained in two tables: the Error Summary and Frame Summary; and each have an equivalent subopcode that is used to obtain the remote results. You can obtain the measurement results by either visually inspecting the corresponding summary trace on the display, or by using CALC:DATA queries that return descriptions of the corresponding summary trace.

Remote Commands

```
:CONFigure:EVM
:FETCh:EVM[n]?
:INITiate:EVM
:MEASure:EVM[n]?
:READ:EVM[n]?
:CALCulate:EVM:DATA<n>:TABLe:STRing?
:CALCulate:EVM:DATA<n>:TABLe:NAMes?
:CALCulate:EVM:DATA<n>:TABLe:UNIT?
:CALC:EVM:DATA4:TABL:STR? "FreqErr"
```

See [“Remote SCPI Commands and Data Queries” on page 1789](#) for more measurement SCPI commands.

Also see [“Data” on page 1730](#) for more measurement SCPI commands.

Remote SCPI Results

These standard remote results are also available thru the CALC:DATA<n> set of queries, where <n> is a reference to the trace number. The results assigned to each trace vary depending on which tests are enabled. As an example, with the default trace layout, the results in the Error Summary results are returned by CALC:EVM:DATA4:TABL:STR?

See the following section: [“Remote SCPI Commands and Data Queries” on page 1789](#).

The following table denotes the LTE Modulation Analysis specific results returned from the (FETCh|MEASure|READ):EVM commands, indexed by subopcode. MEASure:EVM<n> performs the equivalent of CONF:EVM;INIT:IMM:FETCh:EVM<n>. This gets you the default measurement, which is a 5 MHz downlink with auto detection of allocations.

Note that valid results are only returned if the Symbols/Errors trace is being computed. It must be selected though it is not necessary for it to be shown in the current Layout. Some table results are string data, rather than numeric. As FETCh|MEASure|READ can only return numeric data, NaN is returned as a placeholder for string data. To get the full table data, including string results (with numbers in ASCII format) use the CALC:EVM:DATA<n>:TABL:STR? query. Use the associated

CALC:EVM:DATA<n>:TABL queries to get information about names and units for the table data.

N	Results Returned (Downlink)
<p>Not specified or n=1</p>	<p>Returns comma-separated scalar results, corresponding exactly to the items returned in the Error Summary:</p> <ol style="list-style-type: none"> 1. EVM (%rms) 2. String result (EVM Sym Time Adjust). NaN returned 3. EVM Pk (%) 4. EVM Pk Index 5. EVM Peak Sub Car Index 6. Data EVM (%rms) – Not available when Detection is Manual and no User is added. 7. 3GPP-defined QPSK EVM (%rms) 8. 3GPP-defined 16QAM EVM (%rms) 9. 3GPP-defined 64QAM EVM (%rms) 10. RS EVM (%rms) 11. RS Tx. Power (dBm). 12. OFDM Sym. Tx. Power (dBm). 13. Freq Error (Hz) 14. Sync Corr (%) 15. String Result (Sync Type). NaN returned. 16. Common Tracking Error (%rms) 17. Symbol Clock Error (ppm) 18. Time Offset (s) 19. IQ Offset (dB) 20. IQ Gain Imbalance (dB) 21. IQ Quad Error (deg) 22. IQ Timing Skew (s) 23. String result (CP Length Mode). NaN returned. 24. String result (Cell ID). NaN returned. 25. String result (Cell ID Group/Sector). NaN returned. 26. String result (RS-OS / PRS). NaN returned. 27. Reference Signal Rx Power (Avg). 28. Reference Signal Rx Quality. <p>If the table has not been selected to appear on any trace, timeout will occur.</p>

N	Results Returned (Downlink)
n=2	Returns the results of the Frame Summary table in numeric format, with NaN in place of string results. Since this table changes depending on the Channel Profile Setup, the data names and units must be determined at run time by using CALC:EVM:DATA<k>:TABL queries

N	Results Returned (Uplink)
Not specified or n=1	<p>Returns comma-separated scalar results, corresponding exactly to the items returned in the Error Summary:</p> <ol style="list-style-type: none"> 1. EVM (%rms) 2. String result (EVM Sym Time Adjust). NaN returned 3. EVM Pk (%) 4. EVM Pk Index 5. EVM Peak Sub Car Index 6. Data EVM (%rms) – Not available when Detection is Manual and no User is added. 7. 3GPP-defined QPSK EVM (%rms) 8. 3GPP-defined 16QAM EVM (%rms) 9. 3GPP-defined 64QAM EVM (%rms) 10. RS EVM (%rms) 11. NaN returned. 12. NaN returned. 13. Freq Error (Hz) 14. Sync Corr (%) 15. String Result (Sync Type). NaN returned. 16. Common Tracking Error (%rms) 17. Symbol Clock Error (ppm) 18. Time Offset (s) 19. IQ Offset (dB) 20. IQ Gain Imbalance (dB) 21. IQ Quad Error (deg) 22. IQ Timing Skew (s) 23. String result (CP Length Mode). NaN returned. <p>If the table has not been selected to appear on any trace, timeout will occur.</p>
n=2	Returns the results of the Frame Summary table in numeric format, with NaN in place of string results. Since this table changes depending on the Channel Profile Setup, the data names and units must be determined at run time by using CALC:EVM:DATA<k>:TABL queries

For more results defined for READ and FETCh, see the following section: “Remote SCPI Commands and Data Queries” on page 1789.

Because the results of MEASure, READ, or FETCh queries are statically defined, you should use the following query:

CALCulate:EVM:DATA<n>:TABLe:STRing?

as this provides both string and numeric results (numeric formatted as ASCII), and the queries

CALCulate:EVM:DATA<n>:TABLe:NAMes?

CALCulate:EVM:DATA<n>:TABLe:UNIT?

to obtain lists of descriptive data names and associated units. For table results that can change dynamically, such as the Frame Summary, these provide the only possible way to interpret remote table data, since static tabulations such as those above will not suffice.

As an example of the above commands, if you have performed CONF:EVM;INIT:IMM;FORM ASCII, then the following commands will return results similar to those shown in the columns below. The FORM ASCII command dictates that the FETC results will be returned as ASCII in a comma-separated list. The CALC:EVM:DATA<n>:TABL query responses are a comma-separated list enclosed in quotes (i.e., they are a single string).

FETC:EVM1	CALC:EVM:DATA4 :TABL:STR?	CALC:EVM:DATA4 :TABL:UNIT?	CALC:EVM:DATA4 :TABL:NAM?
9.2223893260E+01	92.22389326	%rms	EVM
9.9100000000E+37	EVM Window End		EVMSymTimeAdj
4.2397593130E+02	423.9759313	%rms	EVMPeak
6.0000000000E+00	6	sym	EVMPeakIdx
2.1000000000E+01	21	subcar	EVMPeakSubcarIdx
8.6673950980E+01	86.67395098	%rms	DataEVM
7.6970986550E+01	76.97098655	%rms	RSEVM
6.6970986550E+01	66.97098655	%rms	3GPPEVMQPSK
9.6673950980E+01	96.67395098	%rms	3GPPEVM16QAM
2.8573950980E+01	28.57395098	%rms	3GPPEVM64QAM
3.9100000000E+01	3.91	dBm/subcar	RSTP
-20.4500000000E+01	-20.45	dBm	OSTP
8.4413310460E+02	844.1331046	Hz	FreqErr
1.0699478450E-01	0.106994784	%	SyncCorr
9.9100000000E+37	P-SS		SyncType
1.6618317400E+01	16.6183174	%rms	CTE

LTE Modulation Analysis Measurement

4.2218131000E+02	422.18131	ppm	SymClkErr
3.4869991450E-03	0.003486999	sec	TimeOffset
-2.2683995020E+01	-22.68399502	dB	IQOffset
-1.1367356920E-01	-0.113673569	dB	IQGainImb
-3.6632873820E-01	-0.366328738	deg	IQQuadErr
-2.6630113160E-09	-2.66E-09	sec	IQTimingSkew
9.9100000000E+37	Normal(auto)		CpLengthMode
9.9100000000E+37	503 (auto)		CellId
9.9100000000E+37	167/2 (auto)		CellIdGroupSector
9.9100000000E+37	Custom		RSPRS
-10.0380000000E+01	-10.038	dBm	RSRP
-6.4700000000E+01	-6.47	dB	RSRQ

In addition, if just the “FreqErr” result is desired, you can obtain it using the command:

CALC:EVM:DATA4:TABL:STR? “FreqErr”

For the example data above, the response will be:

“844.1331046”

Key Path	Meas
Mode	LTE, LTETDD
Initial S/W Revision	Prior to A.02.00
Modified at S/W Revision	A.03.00, A.06.00

AMPTD (Amplitude) Y Scale

See “[AMPTD Y Scale \(Amplitude\)](#)” on page 1657 in the section "Common Measurement Functions 2" for a description of this function.

Key Path	Front Panel
----------	-------------

Auto Couple

See “[Auto Couple](#)” on page 1412 in the section "Common Measurement Functions" for a description of this function.

Key Path	Front Panel
----------	--------------------

BW (Bandwidth)

The BW key provides access to a menu that enables you to set the FFT Window for the Spectrum and Inst Spectrum measurement results.

See “[BW \(Bandwidth\)](#)” on page 1664 for more information.

Key Path	Front Panel
----------	-------------

Cont (Continuous)

See “[Cont \(Continuous Measurement/Sweep\)](#)” on page 1413 in the section "Common Measurement Functions" for more information.

Key Path	Front Panel
----------	--------------------

FREQ Channel

See “[FREQ Channel](#)” on page 1667 for a description of this function.

Key Path	Front Panel
----------	--------------------

Center Freq

Sets the frequency of the display Center. See “[Center Freq](#)” on page 1668 for more information.

Key Path	FREQ Channel
----------	---------------------

Start Freq

Sets the frequency of the display Start.

Key Path	FREQ Channel
Mode	LTE, LTETDD
Remote Command	[:SENSE] :FREQuency:STARt <freq> [:SENSE] :FREQuency:STARt?
Example	FREQ:STAR 980 MHz FREQ:STAR?
Couplings	Stop Freq, Center Freq, and Span. See “ FREQ Channel ” on page 853 for more details.
Preset	Depends on span option. It is 1/2 max span below 1 GHz
State Saved	Saved in instrument state.
Min	-9.9e37
Max	9.9e37
Initial S/W Revision	Prior to A.02.00
Modified at S/W Revision	A.02.00

Stop Freq

Sets the frequency of the display Stop.

Key Path	FREQ Channel
Mode	LTE, LTETDD

LTE Modulation Analysis Measurement
FREQ Channel

Remote Command	[:SENSE] :FREQuency:STOP <freq> [:SENSE] :FREQuency:STOP?
Example	FREQ:STOP 990 MHz FREQ:STOP?
Couplings	Start Freq, Center Freq, and Span. See “ FREQ Channel ” on page 853 for more details.
Preset	Depends on span option. It is 1/2 max span above 1 GHz
State Saved	Saved in instrument state.
Min	-9.9e37
Max	9.9e37
Initial S/W Revision	Prior to A.02.00
Modified at S/W Revision	A.02.00

CF Step

Controls the amount the center frequency changes if it is the active function and the user presses the Up or Down arrow key. See “[CF Step](#)” on page 1670 for more information.

Key Path	FREQ Channel
----------	---------------------

Input/Output

Provides a menu that enables you to select input/output parameters for the measurement data.

See [“Input/Output” on page 1422](#) in the section "Common Measurement Functions" for more information.

Key Path	Front Panel
----------	--------------------

Marker

See “[Marker](#)” on page 1670 for a description of this function.

Key Path	Front Panel
----------	--------------------

Marker Function

See [“Marker Function” on page 1689](#) for a description of this function.

Key Path	Front Panel
----------	--------------------

Marker -> (Marker To)

See “[Marker -> \(Marker To\)](#)” on page 1686 for a description of this function.

Key Path	Front Panel
----------	-------------

Meas (Measure)

See [“Meas” on page 1520](#) in the section "Common Measurement Functions 1" for a description of this function.

Key Path	Front Panel
----------	-------------

Meas Setup (Measurement Setup)

Displays a menu that enables you to select measurement parameters for the current measurement.

See “[Meas Setup](#)” on page 1697 for more information.

Key Path	Front Panel
Mode	LTE, LTETDD
Initial S/W Revision	Prior to A.02.00
Modified at S/W Revision	A.03.00

Avg Number

Turns averaging on or off and sets the number of time record measurement results that will be averaged. There are no SCPI/features unique to this measurement.

See “[Avg Number](#)” on page 1697 for more information.

Key Path	Meas Setup
Mode	LTE, LTETDD
Initial S/W Revision	Prior to A.02.00
Modified at S/W Revision	A.03.00

Averaging applies to a limited set of measurement results in LTE Modulation Analysis. RMS and Max average types apply to the Spectrum and Ch Frequency Response traces. The behavior for these types is the same as in the Vector Analysis Measurement. Averaging of numeric error data in the symbol table is described below:

Average Type	Average Mode	Effects of averaging
RMS	any (single sweep)	After each scan, the Syms/Err table shows a running (linear) average over past scans for each parameter in the table. Peak or position parameters are not averaged. Parameters that appear in the table in dB are converted to linear units in order to average them. The measurement stops after the specified Avg Number of scans.
RMS	repeat (continuous sweep)	Same as above, except that averages are reset after the specified Avg Number of scans, and the measurement continues.
RMS	exponential (continuous sweep)	Same as the single sweep case until the specified Avg Number of scans is complete. After that, averaging continues using exponential weighting.

Max	any	After each scan, compares each parameter in the table with the current scan's value and keeps the maximum. Symbol positions relate to the maximum peak value seen.
-----	-----	--

Average Mode

Average Mode determines what happens if the Sweep Control is in Continuous mode and the number of time records processed exceeds the Average Number. If the Sweep Control is in Single mode, this setting has no effect. There are no SCPI/features unique to this measurement.

See [“Average Mode” on page 1698](#) for more information.

Key Path	Meas Setup
----------	-------------------

Average Setup

These parameters are for less commonly needed averaging setups. There are no SCPI/features unique to this measurement.

See [“Average Setup” on page 1699](#) for more information.

Key Path	Meas Setup
----------	-------------------

Sync/Format Setup (Downlink)

Displays a menu of commonly used sync/format setup parameters when Direction is set to Downlink.

Key Path	Meas Setup
Mode	LTE, LTETDD
Initial S/W Revision	Prior to A.02.00
Modified at S/W Revision	A.03.00

Sync Type

Selects the Sync Type.

- PSS – Selects Primary Sync Signal for Sync Type
- RS – Selects Reference Signal for Sync Type

Sync Type sets the channel or signal to be used for synchronization.

The LTE demodulator can be set to use either the Primary Sync signal (P-SS) or the Reference Signal (RS) to synchronize the downlink signal.

This synchronization is performed at the frame level. For smaller scale adjustments (such as at the symbol or slot level), see the [“EVM Minimization” on page 1165](#) parameter.

P-SS is normally used for downlink synchronization. However, when P-SS is impaired in some way (for example, P-SS has a different [“Cell ID” on page 864](#) from RS), RS can be used for synchronization so

LTE Modulation Analysis Measurement
Meas Setup (Measurement Setup)

that the signal can be demodulated.

Note that S-SS must be present in the time capture (Raw Main Time) for demodulation to occur, since finding S-SS is the only way to distinguish between the beginning and the middle of a frame.

When Sync Type is set to RS:

The Error Summary data result SyncCorr shows which Tx antenna port's reference signal was used for synchronization to the right of the correlation value.

Auto detection of Cell ID and Custom RS-PRS are not supported.

The reference Tx antenna port must be specified, since the demodulator does not automatically search the reference input channel for all Tx antenna ports when Sync Type is set to RS.

Key Path	Meas Setup, Sync/Format Setup,
Mode	LTE, LTETDD
Remote Command	[:SENSE] :EVM:DLINK:SYNC:TYPE PSS RS [:SENSE] :EVM:DLINK:SYNC:TYPE?
Example	EVM:DLIN:SYNC:TYPE PSS EVM:DLIN:SYNC:TYPE?
Dependencies	When Sync Type is set to RS, auto detection of Cell ID and Custom RS-PRS are not supported.
Preset	PSS
State Saved	Saved in instrument state.
Range	P-SS RS
Initial S/W Revision	Prior to A.02.00
Modified at S/W Revision	A.03.00

P-SS

Selects P-SS Sync Type.

P-SS is the Primary Synchronization signal for an LTE downlink frame. The center 72 subcarriers (6 RB wide) are allocated to P-SS, but only the center 62 subcarriers are used. The unused subcarriers (the outer five on each side) are set to zero power during P-SS transmission. P-SS is not present in an uplink frame.

For FDD frame type 1, P-SS is present in the last symbol of slots 0 and 11 in every frame.

For TDD frame type 2, P-SS is present in the third symbol of slots 2 and 12 in every frame.

NOTE See [“Edit Control Channels” on page 897](#) for information on setting P-SS Power Boost.

P-SS is transmitted as a Zadoff-Chu sequence and thus appears as irregularly spaced points on a circle in

the IQ Meas constellation diagram.

Key Path	Meas Setup, Sync/Format Setup, Sync Type
Mode	LTE, LTETDD
Initial S/W Revision	Prior to A.02.00
Modified at S/W Revision	A.03.00

RS

Selects RS (Ref Signal) Sync Type.

RS is the downlink Cell-specific Reference Signal and is used for “EVM Minimization” on page 1165 and Equalizer Training, and it can be used for synchronization. The reference signal is also used as the power level reference for the rest of the signal. See “Edit Control Channels” on page 897 for more information.

The modulation type of RS is QPSK.

Key Path	Meas Setup, Sync/Format Setup, Sync Type
Mode	LTE, LTETDD
Initial S/W Revision	Prior to A.02.00
Modified at S/W Revision	A.03.00

RS-PRS

Sets the RS-PRS.

- 3GPP – The demodulator will expect the RS pseudorandom sequence to follow the formula given in the LTE standard in Section 6.10.1.1 of 3GPP TS 36.211.
- CUSTom – The demodulator will autodetect the RS sequence (including non-standard sequences). Since the RS points can only be in certain positions, the demodulator will assume that the point closest to the measured point is the desired reference signal point and will calculate the EVM and other metrics using the assumed reference signal constellation point.

RS-PRS specifies whether or not the demodulator should expect the reference signal sequence to adhere to the standard.

NOTE

When Sync Type is set to RS, autodetecting of a Custom RS-PRS is not supported since the demodulator needs to know the RS-PRS to be able to synchronize the signal using RS.

When RS-PRS is set to Custom and any of the antenna port signals are phase delayed by more than 45 degrees, the demodulator will autodetect a different RS-PRS. This will cause equalization to be incorrect and demodulation will fail. To ensure correct demodulation of signals containing an antenna port transmission with a phase rotation of more than 45 degrees, set RS-PRS to 3GPP to enable

RS-PRS to be determined by Cell ID according to the standard.

Key Path	Meas Setup, Sync/Format Setup
Mode	LTE, LTETDD
Remote Command	[:SENSE] :EVM:DLINK:SYNC:RSPRS GPP CUSTom [:SENSE] :EVM:DLINK:SYNC:RSPRS?
Example	EVM:DLIN:SYNC:RSPR CUSTom EVM:DLIN:SYNC:RSPR?
Dependencies	When Sync Type for Downlink is set to RS, the Custom selection is disabled and the softkey is grayed out.
Preset	GPP
State Saved	Saved in instrument state.
Range	3GPP Custom
Initial S/W Revision	Prior to A.02.00
Modified at S/W Revision	A.03.00

Cell ID

Auto-detects the Cell ID from the SSCH content or to manually select the Cell ID.

Cell ID sets the physical (PHY) layer Cell Identity. This PHY-layer Cell ID determines the Cell ID Group and Cell ID Sector. There are 168 possible Cell ID groups and 3 possible Cell ID sectors; therefore, there are $3 * 168 = 504$ possible PHY-layer Cell IDs. When Cell ID is set to Auto, the analyzer will automatically detect the Cell ID. When Cell ID is set to Manual, the PHY-layer Cell ID must be specified for successful demodulation.

The physical layer Cell ID can be calculated from the following formula:

$$\text{PHY-layer Cell ID} = 3 * (\text{Cell ID Group}) + \text{Cell ID Sector}$$

When Sync Type is set to RS, the Cell ID Auto selection will be disabled, and Cell ID must be specified manually. This is because the demodulator needs to know the values of the RS sequence to use for synchronization and because Cell ID determines these values. See “RS-PRS” on page 863 for more information.

NOTE Cell ID Sector and Group information can be found on the Error Summary trace.
 Only cell-specific reference signals are supported by the LTE demod (MBSFN and UE-specific reference signals are not supported).

Cell ID Sector determines the Zadoff-Chu Root Index used to generate the Primary Synchronization Signal (P-SS):

Cell ID sector 0 = ZC Root Index 25

Cell ID sector 1 = ZC Root Index 29

Cell ID sector 2 = ZC Root Index 34

Normally, the same sequence used to generate P-SS is used to generate RS, but a custom RS can be used by setting RS-PRS to Custom.

Key Path	Meas Setup, Sync/Format Setup
Mode	LTE, LTETDD
Remote Command	[:SENSe] :EVM:DLINk:SYNC:CID <integer> [:SENSe] :EVM:DLINk:SYNC:CID? [:SENSe] :EVM:DLINk:SYNC:CID:AUTO OFF ON 0 1 [:SENSe] :EVM:DLINk:SYNC:CID:AUTO?
Example	EVM:DLIN:SYNC:CID 0 EVM:DLIN:SYNC:CID? EVM:DLIN:SYNC:CID:AUTO ON
Dependencies	When Sync Type for Downlink is set to RS, the Cell ID Auto selection is disabled and Cell ID must be specified manually.
Preset	0 ON
State Saved	Saved in instrument state.
Min	0
Max	503
Initial S/W Revision	Prior to A.02.00
Modified at S/W Revision	A.03.00

Tx Antenna

Displays a menu of Tx Antenna parameters.

Key Path	Meas Setup
Mode	LTE, LTETDD
Initial S/W Revision	Prior to A.02.00
Modified at S/W Revision	A.03.00

Number of Tx Antenna

Selects the number of Tx Antennas.

- ANT1 – 1 Antenna

LTE Modulation Analysis Measurement
Meas Setup (Measurement Setup)

- ANT2 – 2 Antennas
- ANT4 – 4 Antennas

Number of Tx Antenna specifies the number of transmit antenna ports there are for the current LTE signal.

This tells the demodulator whether the signal (or signals, for MIMO case) has been generated as single antenna signal or as a 2x or 4x antenna MIMO signal and therefore determines how many Tx antenna port signals the demodulator searches for.

NOTE When RS-PRS is set to Custom and any of the antenna port signals are phase delayed by more than 45 degrees, the demodulator will autodetect a different RS-PRS. This will cause equalization to be incorrect and demodulation will fail. To ensure correct demodulation of signals containing an antenna port transmission with a phase rotation of more than 45 degrees, set RS-PRS to 3GPP to enable RS-PRS to be determined by Cell ID according to the standard.

Key Path	Meas Setup, Sync/Format Setup
Mode	LTE, LTETDD
Remote Command	[:SENSE] :EVM:DLINK:SYNC:ANTenna:NUMBer ANT1 ANT2 ANT4 [:SENSE] :EVM:DLINK:SYNC:ANTenna:NUMBer?
Example	EVM:DLIN:SYNC:ANT:NUMB ANT1
Dependencies	When Sync Type for Downlink is set to RS, the Custom selection is disabled and the softkey is grayed out.
Preset	ANT1
State Saved	Saved in instrument state.
Range	1 Antenna 2 Antennas 4 Antennas
Initial S/W Revision	Prior to A.02.00
Modified at S/W Revision	A.03.00

1 Antenna

Selects one TX Antenna.

Key Path	Meas Setup, Sync/Format Setup, TX Antenna, Num Tx Antenna
Mode	LTE, LTETDD
Initial S/W Revision	Prior to A.02.00
Modified at S/W Revision	A.03.00

2 Antennas

Selects two TX Antennas.

Key Path	Meas Setup, Sync/Format Setup, TX Antenna, Num Tx Antenna
Mode	LTE, LTETDD
Initial S/W Revision	Prior to A.02.00
Modified at S/W Revision	A.03.00

4 Antennas

Selects four TX Antennas.

Key Path	Meas Setup, Sync/Format Setup, TX Antenna, Num Tx Antenna
Mode	LTE, LTETDD
Initial S/W Revision	Prior to A.02.00
Modified at S/W Revision	A.03.00

Reference Tx Antenna Port

Selects which Reference Tx Antenna Port to use.

- P0 – Antenna Port 0
- P1 – Antenna Port 1
- P2 – Antenna Port 2
- P3 – Antenna Port 3

Reference Tx Antenna Port determines which path to use for synchronization and initial equalization and to show on certain non-MIMO traces (listed below).

Auto/Man selection enables you to specify whether the analyzer uses auto-detection or manual mode to determine the reference Tx antenna port.

Auto - The Tx antenna signal path with the strongest reference signal on the input signal.

Man – Selected Tx antenna port is used as the reference Tx antenna port.

The RS power of the current Tx path is used to set the reference level for the other Tx RS power levels. For example, when Tx port 0 is selected, the Tx0 section of MIMO Info Table will show 0 dB for RSPwr and the other Tx path's RSPwr will be expressed in dB relative to this 0 dB point.

NOTE

In the absence of cross-channel paths (when connecting directory to the Tx antenna ports), make sure that the Tx path selected is present; otherwise, the signal will not be demodulated.

When **Sync Type** is set to **P-SS** and Reference Tx Antenna Port is Auto, the demodulator will automatically detect the strongest Tx path to use for the reference

path.

When **Sync Type** is set to **RS**, reference path auto detection is not supported and the reference Tx antenna path must be specified manually.

This parameter also determines which Tx path results are shown on the following Demod traces:

- Eq Chan Freq Resp
- Eq Chan Freq Resp Diff
- Eq Impulse Response
- Common Tracking Error
- Inst Eq Chan Freq Resp
- Inst Eq Chan Freq Resp Diff
- Freq Err per Slot

To show information for all detected antenna port signals, use the MIMO traces (Trace > Data > MIMO).

NOTE

When the reference signal (RS) for the reference Tx-to-Rx path is not present in the signal, demodulation will fail.

P-SS and S-SS must be present in the time capture (Raw Main Time) of one of the channels connected to the analyzer for successful demodulation to occur. For example, for two-channel transmit diversity signal that has P-SS and S-SS transmitted only on Tx port 1, the demodulator can analyze Tx port 1 without Tx port 0 connected, but not vice versa.

Key Path	Meas Setup, Sync/Format Setup, Tx Antenna
Mode	LTE, LTETDD
Remote Command	[:SENSE] : EVM : DLINK : SYNC : ANTenna : PORT P0 P1 P2 P3 [:SENSE] : EVM : DLINK : SYNC : ANTenna : PORT? [:SENSE] : EVM : DLINK : SYNC : ANTenna : PORT : AUTO OFF ON 0 1 [:SENSE] : EVM : DLINK : SYNC : ANTenna : PORT : AUTO?
Example	EVM:DLIN:SYNC:ANT:PORT P0 EVM:DLIN:SYNC:ANT:PORT?
Dependencies	When Number of Tx Antenna is One, only Port 0 is enabled and the others are disabled. When Number of Tx Antenna is two, Port 0 and Port 1 are enabled and the others are disabled. When Number of Tx Antenna is four, all Ports are enabled.
Preset	P0 ON

State Saved	Saved in instrument state.
Range	Port 0 Port 1 Port 2 Port 3
Initial S/W Revision	Prior to A.02.00
Modified at S/W Revision	A.03.00

Port 0

Selects Port 0 for the TX Antenna Port.

Key Path	Meas Setup, Sync/Format Setup, TX Antenna, TX Antenna Port
Mode	LTE, LTETDD
Initial S/W Revision	Prior to A.02.00
Modified at S/W Revision	A.03.00

Port 1

Selects Port 1 for the TX Antenna Port.

Key Path	Meas Setup, Sync/Format Setup, TX Antenna, TX Antenna Port
Mode	LTE, LTETDD
Initial S/W Revision	Prior to A.02.00
Modified at S/W Revision	A.03.00

Port 2

Selects Port 2 for the TX Antenna Port.

Key Path	Meas Setup, Sync/Format Setup, TX Antenna, TX Antenna Port
Mode	LTE, LTETDD
Initial S/W Revision	Prior to A.02.00
Modified at S/W Revision	A.03.00

Port 3

Selects Port 3 for the TX Antenna Port.

Key Path	Meas Setup, Sync/Format Setup, TX Antenna, TX Antenna Port
Mode	LTE, LTETDD
Initial S/W Revision	Prior to A.02.00
Modified at S/W Revision	A.03.00

Antenna Detect Threshold

Sets the Antenna Detection Threshold.

Antenna Detection Threshold sets the threshold for transmit antenna port signal detection. The average RS power from a Tx antenna port has to be above the Antenna Detection Threshold to be detected by the demodulator. The threshold is specified relative to the average RS subcarrier power level of the reference antenna path selected.

For example, a combination of the transmissions from Ports 0–3 are being received, Antenna Detection Threshold is set to –10 dB, Reference Tx Antenna Port is set to Port 1. The demodulator will set the detection threshold 10 dB below the average RS power level of the reference antenna path (Tx1). Any other antenna port transmission paths with an average RS power level that is at or below this threshold will not be detected nor included in demodulation results. However, any undetected transmissions will affect EVM since they will not be equalized and will act as noise.

NOTE Include Inactive Antenna Paths can be used to show information about all Tx paths on the MIMO trace.

Key Path	Meas Setup, Sync/Format Setup, Tx Antenna,
Mode	LTE, LTETDD
Remote Command	[:SENSe] :EVM:DLINk:SYNC:ANTenna:DETECT:THRshold <rel_ampl> [:SENSe] :EVM:DLINk:SYNC:ANTenna:DETECT:THRshold?
Example	EVM:DLIN:SYNC:ANT:DET:THR –10 EVM:DLIN:SYNC:ANT:DET:THR?
Dependencies	This parameter is disabled when Number of Tx Antenna is One.
Preset	–10
State Saved	Saved in instrument state.
Min	–100 dB
Max	100 dB
Initial S/W Revision	Prior to A.02.00
Modified at S/W Revision	A.03.00

P-SS/S-SS Antenna Port

Selects the Antenna Port that is transmitting P-SS/S-SS when the Number of Tx Antenna is set to 2 Antennas or 4 Antennas.

When All Ports is selected, the Power Boost value for P-SS and S-SS entered in Downlink Control Channel Properties is assumed to be split equally among the transmit antennas.

For example, when P-SS Power Boost = 0.6 dB and P-SS/S-SS Antenna Port is set to All Ports for a four

antenna port signal, the demodulator will expect P-SS power on each antenna port to be 0.6 dB – 6.02 dB = –5.38 dB.

Otherwise, when Port 0, Port 1, Port 2, or Port 3 is selected, the entire power specified by the P-SS and S-SS Power Boost parameter is assumed to be transmitted on the selected antenna port.

- PORT0 – Port 0
- PORT1 – Port 1
- PORT2 – Port 2
- PORT3 – Port 3
- APORts – All Ports

Key Path	Meas Setup, Sync/Format Setup, Tx Antenna
Mode	LTE, LTETDD
Remote Command	[:SENSE] :EVM:DLINk:SYNC:SS:ANTenna:PORT P0 P1 P2 P3 APORts [:SENSE] :EVM:DLINk:SYNC:SS:ANTenna:PORT?
Example	EVM:DLIN:SYNC:SS:ANT:PORT P0 EVM:DLIN:SYNC:SS:ANT:PORT?
Dependencies	Disabled when Number of Tx Antenna is One.
Preset	P0
State Saved	Saved in instrument state.
Range	Port 0 Port 1 Port 2 Port 3 All Ports
Initial S/W Revision	A.03.00

Port 0

Selects Port 0.

Key Path	Meas Setup, Sync/Format Setup, Tx Antenna, P-SS/S-SS Ant
Mode	LTE, LTETDD
Initial S/W Revision	A.03.00

Port 1

Selects Port 1.

Key Path	Meas Setup, Sync/Format Setup, Tx Antenna, P-SS/S-SS Ant
Mode	LTE, LTETDD
Initial S/W Revision	A.03.00

LTE Modulation Analysis Measurement
Meas Setup (Measurement Setup)

Port 2

Selects Port 2.

Key Path	Meas Setup, Sync/Format Setup, Tx Antenna, P-SS/S-SS Ant
Mode	LTE, LTETDD
Dependencies	Disabled when Number of Tx Antenna is Two.
Initial S/W Revision	A.03.00

Port 3

Selects Port 3.

Key Path	Meas Setup, Sync/Format Setup, Tx Antenna, P-SS/S-SS Ant
Mode	LTE, LTETDD
Dependencies	Disabled when Number of Tx Antenna is Two.
Initial S/W Revision	A.03.00

All Ports

Selects All Ports.

Key Path	Meas Setup, Sync/Format Setup, Tx Antenna, P-SS/S-SS Ant
Mode	LTE, LTETDD
Initial S/W Revision	A.03.00

Include Inactive Antenna Paths

Selects whether or not inactive antenna paths are included in the result.

- Include - All Tx/Rx antenna paths are shown on the MIMO traces whether or not the path is present.
- Exclude - Only Tx/Rx antenna paths that have an average RS power above the antenna detection threshold will be shown on the MIMO traces.

Key Path	Meas Setup, Sync/Format Setup, Tx Antenna
Mode	LTE, LTETDD
Remote Command	[:SENSe] :EVM:DLINK:SYNC:ANTenna:INACTive:PATHs INCLude EXCLude [:SENSe] :EVM:DLINK:SYNC:ANTenna:INACTive:PATHs?
Example	EVM:DLIN:SYNC:ANT:INAC:PATH INCL EVM:DLIN:SYNC:ANT:INAC:PATH?
Preset	EXCLude

State Saved	Saved in instrument state.
Range	Include Exclude
Initial S/W Revision	A.06.00

MIMO Decoding

Determines the MIMO decoding method.

- NONE – No decoding
- GPPMimo – Selects 3GPP MIMO decoding

MIMO Decoding determines how much of the transmit chain is decoded by the demodulator. The selection of this parameter directly affects what values are shown on the IQ Meas trace and all other traces that depend on the IQ Meas data (error vector traces).

MIMO Decoding applies to multi-antenna signals only.

3GPP MIMO Decoding

When 3GPP MIMO Decoding is selected, the data points shown on the IQ Meas trace are equivalent to the data points before precoding was applied in the transmit chain. In other words, the demodulator will undo MIMO precoding and show the results on IQ Meas. Although the data points are mapped onto "subcarriers" when being shown on the layer traces, the data points do not have a one-to-one correspondence to the subcarrier that they are mapped onto. For instance, when there is a frequency null that affects a subcarrier, there will be several (depending on the precoding) data points in IQ Meas that are affected. Another way of looking at this is that each subcarrier contains information from multiple data points after precoding is performed (this does not apply to RS, P-SS, and S-SS which do not undergo precoding).

For channels that undergo transmit diversity, the demodulator will undo transmit diversity precoding, undo codeword-to-layer mapping, and show the resulting codeword data points in their respective resource elements, copied on all layer traces. That is, constellation points on layer traces for transmit diversity-precoded channels will be the same for all layer traces.

When a signal uses Tx Diversity, the amount of data transmitted is not increased, but the reliability of the signal is increased by transmitting multiple copies of the data.

In two Tx Antenna mode, each antenna port transmission carries enough information to determine all the data.

In four Tx Antenna mode, each antenna port transmission only carries enough information to determine half the data. Any data that cannot be determined from the detected antenna ports will be considered part of Non-Alloc signals and shown as blanks on the Symbol Table (unless the Non-Alloc parameter is selected; then the data will be shown as gray zeros).

For channels that undergo spatial multiplexing, the demodulator will only undo Spatial Multiplexing precoding and show the layer data points in their respective resource elements on the appropriate layer traces.

For precoded channels, subcarrier points on the layer traces do not have a one-to-one correspondence to on-air subcarriers. Rather, each subcarrier point is actually the demodulated value of a codeword data point that was present prior to the codeword-to-layer mapping at the transmitter.

NOTE For LTE signals that contain more than one layer, the P-SS and S-SS subcarriers from the P-SS/S-SS Antenna Port are copied to all layer traces. RS subcarriers from all Tx antenna ports are copied to their respective subcarrier/symbol locations in all layer traces.

No Decoding

When No Decoding is selected, no decoding or cross-channel equalization will be performed on the measured IQ data. This means that, for LTE signals that have been precoded (multi-antenna signals), subcarrier points shown on measured IQ traces (IQ Meas and IQ MEas Time) will actually be an addition of multiple modulation points, resulting in non-standard constellations.

For example, in a two antenna port signal, there will be subcarrier points that are an addition of two QPSK points. The resulting diagram will be a 9QAM constellation. These are effectively the points that were transmitted on the OFDM subcarriers.

Reference antenna path equalization will still be performed when Equalizer Training is enabled (set to RS or RS+Data).

The No Decoding selection is useful for the case that you have four antenna signals, and you want to isolate channel effects from transmit chain effects (filters, mixers, etc.). You could connect each transmit port directly to your measurement instrument with identical cables. That way, any observed anomalies will come primarily from the RF transmit chain.

NOTE When No Decoding is selected, EVM results will not be relevant since the ideal symbol points (shown on the IQ Ref and IQ Ref Time), which are used to compute EVM, will still be standard constellation points and hence may not match the non-standard constellation points of IQ Meas arising due to No Decoding.

Key Path	Meas Setup, Sync/Format Setup
Mode	LTE, LTETDD
Remote Command	[:SENSe] :EVM:DLINk:SYNC:MIMO:DECoding NONE GPPMimo [:SENSe] :EVM:DLINk:SYNC:MIMO:DECoding?
Example	EVM:DLIN:SYNC:MIMO:DEC NONE EVM:DLIN:SYNC:MIMO:DEC?
Notes	The selection “JEqualizer” is removed at A.06.00. For backward compatibility, when it is sent, this parameter is set to GPPM, the Preset value.
Preset	3GPP MIMO
State Saved	Saved in instrument state.
Range	None 3GPP MIMO
Initial S/W Revision	A.03.00

Modified at S/W Revision	A.06.00
--------------------------	---------

PDSCH Cell Specific Ratio

Determines PDSCH cell-specific ratio ρ_B/ρ_A or cell-specific parameter PB. (3GPP TS 36.213 V8.5.0 5.2) PDSCH cell-specific ratio specifies the power ratio between PDSCH resource elements and cell-specific reference signal elements.

- R1 – Cell-specific ratio $\rho_B/\rho_A =$ always 1 (0 dB)
- PB0 – Cell-specific parameter PB = 0
- PB1 – Cell-specific parameter PB = 1
- PB2 – Cell-specific Parameter PB = 2
- PB3 – Cell-specific parameter PB = 3

When PB(x) is selected, the LTE parameter P_B will be set to (x), and the ratio ρ_B/ρ_A will be determined from Table 5.2–2 in 3GPP TS.36.213.

When R1 is selected, the cell-specific ratio ρ_B/ρ_A will be set to 1.

Key Path	Meas Setup, Sync/Format Setup
Mode	LTE, LTETDD
Remote Command	[:SENSe] :EVM:DLINK:PDSch:CSRatio R1 PB0 PB1 PB2 PB3 [:SENSe] :EVM:DLINK:PDSch:CSRatio?
Example	EVM:DLIN:PDSC:CSR R1 EVM:DLIN:PDSC:CSR?
Preset	$\rho_B/\rho_A = 1$
State Saved	Saved in instrument state.
Range	$\rho_B/\rho_A = 1 PB = 0 PB = 1 PB = 2 PB = 3$
Initial S/W Revision	A.03.00

Sync/Format Setup (Uplink)

Displays a menu of commonly used sync/format setup parameters when Direction is set to Uplink.

Key Path	Meas Setup
Mode	LTE, LTETDD
Initial S/W Revision	Prior to A.02.00
Modified at S/W Revision	A.03.00

Sync Type (Uplink)

Selects the Sync Type to use.

- RS – Selects PUSCH DM-RS as the Sync Type
- PUCCh – Selects PUCCH DM-RS as the Sync Type
- SRS – Selects S-RS as the Sync Type
- PRACH – Selects PRACH as the Sync Type

Sync Type sets the channel or signal to use for synchronization.

The demodulator can use PUSCH DM-RS, PUCCH DM-RS, S-RS, or PRACH for synchronization. Only the channels or signals that are defined for the current user (by selecting the Active to On for that signal in the User Mapping Editor) will be available as synchronization options.

Note that PUSCH, PUCCH, PUSCH DM-RS, PUCCH DM-RS, and SRS powers in the User Mapping Editor are specified relative to the 0 dB level determined by the power of the channel chosen for synchronization. For example, when:

- Sync Type is set to PUCCH DM-RS
- PUCCH DMRS Power (dB) = 3 dB
- PUSCH Power (dB) = 1.2 dB,

the demodulator will set the 0 dB level to be 3 dB below the average power of PUCCH DM-RS and expect PUSCH average power to be 1.2 dB above the 0 dB level, which is equivalent to 1.8 dB below the average PUCCH DM-RS power.

Sync Type also determines which channel's Sync Slot parameter is used for frame boundary calculation.

Key Path	Meas Setup, Sync/Format Setup, More
Mode	LTE, LTETDD
Remote Command	[:SENSe] :EVM:ULINk:SYNC:TYPE RS PUCCh SRS PRACH [:SENSe] :EVM:ULINk:SYNC:TYPE?
Example	EVM:ULIN:SYNC:TYPE RS EVM:ULIN:SYNC:TYPE?
Dependencies	Only the channels or signals that are defined for the current user (by turn on Active for that signal in the LTE Allocation Editor) are available as synchronization options. For example, if a user does not have a PUCCH allocation defined, the PUCCH DM-RS synchronization option is disabled
Preset	RS
State Saved	Saved in instrument state.
Range	PUSCH DM-RS PUCCH DM-RS S-RS PRACH
Initial S/W Revision	Prior to A.02.00

Modified at S/W Revision	A.03.00
--------------------------	---------

PUSCH DM-RS

Selects PUSCH DM-RS as the Sync Type.

Key Path	Meas Setup, Sync/Format Setup, More, Sync Type
Mode	LTE, LTETDD
Initial S/W Revision	Prior to A.02.00
Modified at S/W Revision	A.03.00

PUCCH DM-RS

Selects PUCCH DM-RS as the Sync Type.

Key Path	Meas Setup, Sync/Format Setup, More, Sync Type
Mode	LTE, LTETDD
Initial S/W Revision	Prior to A.02.00
Modified at S/W Revision	A.03.00

S-RS

Selects S-RS as the Sync Type.

Key Path	Meas Setup, Sync/Format Setup, More, Sync Type
Mode	LTE, LTETDD
Initial S/W Revision	A.03.00

PRACH

Selects PRACH as the Sync Type.

Key Path	Meas Setup, Sync/Format Setup, More, Sync Type
Mode	LTE, LTETDD
Initial S/W Revision	A.03.00

Half Subcarrier Shift

Sets the state of Half Carrier Shift. When Half Subcarrier Shift is selected, the demodulator expects the uplink signal to comply with the LTE standard regarding subcarrier shift and phase reset. The LTE standard requires that the uplink subcarriers be spaced on either side of DC by half the subcarrier spacing. When this is done, a phase reset is also needed after each symbol.

To demodulate a signal that does not shift the subcarriers by half the subcarrier spacing (and therefore does not need a phase reset), set this parameter to OFF.

LTE Modulation Analysis Measurement
Meas Setup (Measurement Setup)

To demodulate a signal that conforms to the half subcarrier shift, but does not reset the phase each symbol, set this parameter to OFF. The signal will then be demodulated correctly, but will show a frequency offset error of 7.5 KHz.

Background

Downlink signals have an odd number of subcarriers, and the middle subcarrier, located at DC, is discarded, since it is generally difficult to recover the data from a DC subcarrier. In contrast, uplink signals have one less subcarrier than the corresponding downlink signal and are shifted down in frequency by half the subcarrier spacing such that the subcarriers are symmetric about DC causing less bandwidth to be wasted.

Key Path	Meas Setup, Sync/Format Setup
Mode	LTE, LTETDD
Remote Command	[:SENSE] :EVM:ULINK:SYNC:HSSHift OFF ON 0 1 [:SENSE] :EVM:ULINK:SYNC:HSSHift?
Example	EVM:ULIN:SYNC:HSSH ON EVM:ULIN:SYNC:HSSH?
Preset	ON
State Saved	Saved in instrument state.
Initial S/W Revision	Prior to A.02.00
Modified at S/W Revision	A.03.00

PUSCH DFT Swap

Sets the state of PUSCH DFT Swap. PUSCH DFT Swap influences how data is mapped to the subcarriers in the Physical Uplink Shared Channel after a discrete Fourier transform is performed. It can be turned on or off to provide two different interpretation of how data should be mapped to resource elements in PUSCH channels.

Key Path	Meas Setup, Sync/Format Setup
Mode	LTE, LTETDD
Remote Command	[:SENSE] :EVM:ULINK:SYNC:PDSwap OFF ON 0 1 [:SENSE] :EVM:ULINK:SYNC:PDSwap?
Example	EVM:ULIN:SYNC:PDSW ON EVM:ULIN:SYNC:PDSW?
Preset	OFF
State Saved	Saved in instrument state.
Initial S/W Revision	Prior to A.02.00
Modified at S/W Revision	A.03.00

Meas Time Setup

Displays a menu of commonly used measurement time setup parameters.

Key Path	Meas Setup
Mode	LTE, LTETDD
Initial S/W Revision	Prior to A.02.00
Modified at S/W Revision	A.03.00

Result Length

Sets the maximum result length for analysis.

Result Length determines how many slots will be available for demodulation. Measurement Interval and Measurement Offset specify what part of the result length is demodulated.

The result data starts where the analysis boundary is found and ends after the amount of data specified by Result Length.

The length of the time capture (contained in Search Time) is longer than the result length by approximately the length of the Analysis Start Boundary (frame = 10 ms, slot = 0.5 ms, etc.) to enable for location of the analysis boundary within the time capture.

NOTE For downlink, an entire slot containing S-SS must be present in the time capture (Raw Main Time) for demodulation to occur.

For LTETDD, the maximum Result Length is 40 slots when Direction is set to Downlink, for Uplink, the maximum Result Length is 20 slots.

Key Path	Meas Setup, Meas Time Setup
Mode	LTE, LTETDD
Remote Command	[:SENSE]:EVM:TIME:RESult:LENGth <integer> [:SENSE]:EVM:TIME:RESult:LENGth?
Example	EVM:TIME:RES:LENG 20 EVM:TIME:RES:LENG?
Preset	20 slots
State Saved	Saved in instrument state.
Min	1 slot
Max	LTE: 20 slots LTETDD: 40 slots for Downlink, 20 slots for Uplink
Initial S/W Revision	Prior to A.02.00

LTE Modulation Analysis Measurement
Meas Setup (Measurement Setup)

Modified at S/W Revision	A.03.00
--------------------------	---------

Meas Offset Slot

Sets the Meas Offset Slot.

Measurement Offset Slot specifies the offset from the Analysis Start Boundary to the beginning of the Measurement Interval (the data sent to the demodulator), and can be specified in slots + symbols-times.

Key Path	Meas Setup, Meas Time Setup
Mode	LTE, LTETDD
Remote Command	[:SENSE]:EVM:TIME:OFFSet:SLOT <integer> [:SENSE]:EVM:TIME:OFFSet:SLOT?
Example	EVM:TIME:OFFS:SLOT 0 EVM:TIME:OFFS:SLOT?
Couplings	Max value determined by Result Length (refer to “Result Length” on page 879)
Preset	0 slots
State Saved	Saved in instrument state.
Min	0 slots
Max	Determined by Result Length (refer to “Result Length” on page 879)
Max	Determined by Result Length (refer to “Result Length” on page 879)
Initial S/W Revision	Prior to A.02.00
Modified at S/W Revision	A.03.00

Meas Offset Symbol

Sets the Meas Offset Symbol.

Measurement Offset Symbol specifies the offset from the Analysis Start Boundary to the beginning of the Measurement Interval (the data sent to the demodulator), and can be specified in slots + symbols-times.

Key Path	Meas Setup, Meas Time Setup
Mode	LTE, LTETDD
Remote Command	[:SENSE]:EVM:TIME:OFFSet:SYMBOL <integer> [:SENSE]:EVM:TIME:OFFSet:SYMBOL?
Example	EVM:TIME:OFFS:SYMB 0 EVM:TIME:OFFS:SYMB?
Preset	0 symbols

State Saved	Saved in instrument state.
Min	0 symbols
Max	6 symbols
Initial S/W Revision	Prior to A.02.00
Modified at S/W Revision	A.03.00

Meas Interval Slot

Sets the Meas Interval Slot.

Measurement Interval determines how much data is sent to the demodulator, and can be specified in slots + symbols-times. The beginning of the measurement interval is specified as an offset from the Analysis Start Boundary. The offset is specified by the Measurement Offset parameter.

NOTE The Time Offset data result in the Error Summary trace shows the distance from the beginning of the Search Time trace to the beginning of the measurement interval.

Key Path	Meas Setup, Meas Time Setup
Mode	LTE, LTETDD
Remote Command	[:SENSE]:EVM:TIME:INTerval:SLOT <integer> [:SENSe]:EVM:TIME:INTerval:SLOT?
Example	EVM:TIME:INT:SLOT 1 EVM:TIME:INT:SLOT?
Couplings	Max value determined by Result Length (refer to “Result Length” on page 879)
Preset	LTE: 6 slots LTETDD: 6 slots
State Saved	Saved in instrument state.
Min	0 slots
Max	Determined by Result Length (refer to “Result Length” on page 879)
Max	Determined by Result Length (refer to “Result Length” on page 879)
Initial S/W Revision	Prior to A.02.00
Modified at S/W Revision	A.03.00

Meas Interval Symbol

Sets the Meas Interval Symbol.

Measurement Interval determines how much data after the measurement offset is sent to the demodulator, and can be specified in slots + symbols-times.

Key Path	Meas Setup, Meas Time Setup
Mode	LTE, LTETDD
Remote Command	[:SENSE] :EVM:TIME:INTERval:SYMBOL <integer> [:SENSE] :EVM:TIME:INTERval:SYMBOL?
Example	EVM:TIME:INT:SYMB 0 EVM:TIME:INT:SYMB?
Preset	0 symbols
State Saved	Saved in instrument state.
Min	0 symbols
Max	6 symbols
Initial S/W Revision	Prior to A.02.00
Modified at S/W Revision	A.03.00

Analysis Start Boundary

Sets the Analysis Start Boundary. Analysis Start Boundary specifies the alignment boundary of the Result Length time data. To ensure that this alignment can be achieved, the total amount of data acquired by the analyzer is equal to the Result Length plus the length of the alignment boundary specified by Analysis Start Boundary. For example, if Analysis Start Boundary were set to Half-Frame, the total acquisition will be equal to ResultLength + 10 slots (and the Measurement Interval will start at a Half-Frame boundary).

Once the Result Length is located within the time capture, Measurement Offset and Measurement Interval determine the data that is to be analyzed. This data is also displayed on the Time trace.

This parameter cannot be set to Slot for downlink signals since MIMO Decoding must be applied beginning at a subframe boundary.

NOTE Since uplink signals do not contain a separate synchronization channel, the demodulator cannot determine the frame boundary exactly unless there is a unique slot in a user mapping and that unique slot is present within the Search Time data.

Key Path	Meas Setup, Meas Time Setup
Mode	LTE, LTETDD

Remote Command	[:SENSE] :EVM:TIME:ASBoundary FRAME HALF SUB SLOT [:SENSE] :EVM:TIME:ASBoundary?
Example	EVM:TIME:ASB FRAM EVM:TIME:ASB?
Dependencies	When Direction is set to Downlink, SLOT cannot be selected and the softkey is grayed out. When Direction is changed to Downlink from Uplink, this parameter is set to FRAME.
Preset	FRAME
State Saved	Saved in instrument state.
Range	Frame Half Frame Sub Frame Slot
Initial S/W Revision	Prior to A.02.00
Modified at S/W Revision	A.03.00

Frame

Selects Frame as Analysis Start Boundary.

Key Path	Meas Setup, Meas Time Setup, Analysis Start Boundary
Mode	LTE, LTETDD
Initial S/W Revision	Prior to A.02.00
Modified at S/W Revision	A.03.00

Half-Frame

Selects Half-Frame as Analysis Start Boundary.

Key Path	Meas Setup, Meas Time Setup, Analysis Start Boundary
Mode	LTE, LTETDD
Initial S/W Revision	Prior to A.02.00
Modified at S/W Revision	A.03.00

SubFrame

Selects SubFrame as Analysis Start Boundary.

Key Path	Meas Setup, Meas Time Setup, Analysis Start Boundary
Mode	LTE, LTETDD
Initial S/W Revision	Prior to A.02.00

LTE Modulation Analysis Measurement Meas Setup (Measurement Setup)

Modified at S/W Revision	A.03.00
--------------------------	---------

Slot

Selects Slot as Analysis Start Boundary. This selection is available when Direction is Uplink.

Key Path	Meas Setup, Meas Time Setup, Analysis Start Boundary
Mode	LTE, LTETDD
Initial S/W Revision	Prior to A.02.00
Modified at S/W Revision	A.03.00

Chan Profile Setup (Downlink)

Displays a menu of commonly used channel profile setup parameters when Direction is Downlink.

Key Path	Meas Setup
Mode	LTE, LTETDD
Initial S/W Revision	Prior to A.02.00
Modified at S/W Revision	A.03.00

Detection

Determines whether or not the user allocations will be autodetected.

Downlink:

When enabled, the demodulator can perform power based auto detection or can auto detect allocations by decoding PDCCH. See the [“RB Auto Detect Mode” on page 885](#) Detect Mode for more information.

Uplink:

When enabled, PUSCH, PUCCH, SRS, and PRACH allocations can be autodetected when the necessary parameters are defined.

NOTE	<p>The LTE demodulator can perform sync slot auto detection or user-assigned auto detection for uplink signals.</p> <p>To configure automatic sync slot detection, select the Auto Sync parameter on the User Mapping Editor.</p> <p>To configure user-assigned auto detection, set the Auto Sync to OFF for a channel and define a sync slot with associated Per-slot Parameters (in the User Mapping Editor) to be used for initial synchronization. User-assigned auto detection results in faster measurements than automatic sync slot detection.</p>
-------------	--

Key Path	Meas Setup, Chan Profile Setup
Mode	LTE, LTETDD
Remote Command	[:SENSE]:EVM:PROfile:AUTO[:DETECT] OFF ON 0 1 [:SENSE]:EVM:PROfile:AUTO[:DETECT]?
Example	EVM:PROF:AUTO ON EVM:PROF:AUTO?
Couplings	This parameter is the same for Downlink and Uplink When Direction is Downlink, this parameter is coupled to the Include User (Downlink) menu. This menu is context sensitive and when Auto Include is on the user can include QPSK, 16QAM or 64QAM channels. When Off the user can include any of the user defined PDSCH channels. When direction is Uplink, this parameter is coupled to the Include User (Uplink) menu. This menu is context sensitive and when Auto Include is On the user can include channels from the Auto Detected User. When Off the user can include channels from ONE of the user defined Users.
Preset	ON
State Saved	Saved in instrument state.
Initial S/W Revision	Prior to A.02.00
Modified at S/W Revision	A.03.00

RB Auto Detect Mode

Sets the level of auto detection that the LTE demodulator uses. There are two levels of auto detection, described as follows:

- **POWer** - Power Based, User allocations are detected using codeword power levels and MIMO parameters. Detected allocations are grouped according to modulation type (QPSK, 16QAM, or 64QAM).
The codeword powers (needed for EVM calculations) and Precoding type are not autodetected and need to be specified.
When SpMux is selected as the precoding type, No. Layers, No. Codewords, CDD, and Codebook Idx must also be specified, and these parameters are assumed to apply to all autodetected PDSCH channels.
- **DECode** - Decoded PDCCH, User allocations are determined by decoding PDCCH.

NOTE The demodulator can be configured to autodetect 3GPP-defined codeword power levels when Auto Detect Power Levels is On. When codeword power levels are not autodetected, they must be specified using the CW0/1 Power parameters in the User Mapping Editor for each expected user allocation. The number of expected user allocations is set by Number of Expected DL Users and by selecting the

individual users.

Key Path	Meas Setup, Chan Profile Setup
Mode	LTE, LTETDD
Remote Command	[:SENSE] :EVM:DLINK:PROF:Auto[:DETECT] :MODE Power DECODED [:SENSE] :EVM:DLINK:PROF:Auto[:DETECT] :MODE?
Example	EVM:DLIN:PROF:Auto:MODE POW EVM:DLIN:PROF:Auto:MODE?
Dependencies	Available when Detection is Auto.
Preset	POWER
State Saved	Saved in instrument state.
Range	Power Based Decoded PDCCH
Initial S/W Revision	A.06.00

Auto Detect Power Levels

Selects whether or not power levels are autodetected.

- ON - Detects the relative PDSCH power level for each user allocation (P_A). RB Auto Detect Mode must be set to Decode PDCCH for power levels to be autodetected.
- OFF - The codeword power levels for each user allocation need to be specified for EVM calculations to be correct. The Expected Num. of Users parameter determines the number of users listed in the LTE Allocation Editor for which the power levels can be defined.

The power levels are detected as one of the levels specified by the standard in 3GPP TS 36.331, section 6.3.2 under the PDSCH-Config parameter.

These power levels are -6 dB, -4.77 dB, -3 dB, -1.77 dB, 0 dB, 1 dB, 2 dB, and 3 dB.

The autodetected power levels ($P_{A(n)}$) can be viewed on the DL Decode Info trace.

Key Path	Meas Setup, Chan Profile Setup
Mode	LTE, LTETDD
Remote Command	[:SENSE] :EVM:DLINK:PROF:Auto[:DETECT] :POWER OFF ON 0 1 [:SENSE] :EVM:DLINK:PROF:Auto[:DETECT] :POWER?
Example	EVM:DLIN:PROF:Auto:POW ON EVM:DLIN:PROF:Auto:POW?
Dependencies	Available Detection is Auto and RB Auto Detect Mode is Decoded PDCCH.

Preset	ON
State Saved	Saved in instrument state.
Range	On Off
Initial S/W Revision	A.06.00

Round to Standard Values

Determines whether the measured, relative power levels for PDSCH allocations are detected as one of the standard values or assumed to be equal to the measured power level.

When on, the power levels are detected as the closest standard power level. Standard power levels are specified in 3GPP TS 36.331, section 6.3.2 under the PDSCH-Config parameter. These power levels are -6 dB, -4.77 dB, -3 dB, -1.77 dB, 0 dB, 1 dB, 2 dB, and 3 dB. When off, the measured power levels are used as the actual power levels.

Key Path	Meas Setup, Chan Profile Setup
Mode	LTE, LTETDD
Remote Command	[:SENSE] :EVM:DLINK:PROF:file:AUTO[:DETect] :POWER:ROUND OFF ON 0 1 [:SENSE] :EVM:DLINK:PROF:file:AUTO[:DETect] :POWER:ROUND?
Example	EVM:DLIN:PROF:AUTO:POW:ROUN ON EVM:DLIN:PROF:AUTO:POW:ROUN?
Dependencies	Available when the following conditions are met. Direction: Downlink Detection: Auto RB Auto Detect Mode: Decoded PDCCH Auto Detect Power Levels: On.
Preset	ON
State Saved	Saved in instrument state.
Range	On Off
Initial S/W Revision	A.10.00

Number of Expected DL Users

Specifies the number of user allocations from 1 to 50 when RB Auto Detect Mode is set to Decoded PDCCH.

Other user allocations detected from PDCCH will be shown on traces and included in calculations, but only the number of users specified with this key will be included in the Composite Include menu where they can be excluded from traces and calculations.

When Auto Detect Power levels is set to OFF, PDSCH Decoded User Power Boost must be specified.

LTE Modulation Analysis Measurement
Meas Setup (Measurement Setup)

This parameter limits the number of PDSCH user allocations for which codeword power levels can be manually defined. When there are more user allocations found in the signal than are specified by this parameter, any additional user allocation will be assumed to have a PDSCH power level of 0 dB.

Key Path	Meas Setup, Chan Profile Setup
Mode	LTE, LTETDD
Remote Command	[:SENSE] :EVM:DLINK:PROFile:EUSers:COUNT <integer> [:SENSE] :EVM:DLINK:PROFile:EUSers:COUNT?
Example	EVM:DLIN:PROF:EUS:COUN 1 EVM:DLIN:PROF:EUS:COUN?
Dependencies	Available when Detection is Auto and RB Auto Detect Mode is Decoded PDCCH.
Preset	3
State Saved	Saved in instrument state.
Min	0
Max	50
Initial S/W Revision	A.06.00

Composite Include

Displays a menu that enables the inclusion or exclusion of all channels.

Key Path	Meas Setup, Chan Profile Setup
Mode	LTE, LTETDD
Initial S/W Revision	Prior to A.02.00
Modified at S/W Revision	A.03.00

Include All

Turns On all Downlink channels.

Key Path	Meas Setup, Chan Profile Setup, Composite Include
Mode	LTE, LTETDD
Remote Command	[:SENSE] :EVM:DLINK:PROFile:INCLude:ALL
Example	EVM:DLIN:PROFile:INCL:ALL

Couplings	Turns On the following parameters Include P-SCH Include S-SCH Include PBCH Include PCFICH Include PHICH Include RS Include PDCCH All Users under the Include Users (Downlink) Menu
Initial S/W Revision	Prior to A.02.00
Modified at S/W Revision	A.03.00

Exclude All

Turns Off all Downlink channels.

Key Path	Meas Setup, Chan Profile Setup, Composite Include
Mode	LTE, LTETDD
Remote Command	[:SENSE] :EVM:DLINK:PROF:EXCLude:ALL
Example	EVM:DLIN:PROF:EXCL:ALL
Couplings	Turns Off the following parameters Include P-SCH Include S-SCH Include PBCH Include PCFICH Include PHICH Include RS Include PDCCH Include Non Allocation All Users under the Include Users (Downlink) Menu
Initial S/W Revision	Prior to A.02.00
Modified at S/W Revision	A.03.00

Include P-SS

Includes the Primary Synchronization Channel in the results.

Key Path	Meas Setup, Chan Profile Setup
----------	---------------------------------------

LTE Modulation Analysis Measurement
Meas Setup (Measurement Setup)

Mode	LTE, LTETDD
Remote Command	[:SENSe] :EVM:DLINk:PROFile:PSS INCLude EXCLude [:SENSe] :EVM:DLINk:PROFile:PSS?
Example	EVM:DLIN:PROF:PSS INCL EVM:DLIN:PROF:PSS?
Couplings	This parameter is set to Include when Downlink Include All is selected and set to Exclude when Downlink Exclude All is selected.
Preset	INCLude
State Saved	Saved in instrument state.
Range	Include Exclude
Initial S/W Revision	Prior to A.02.00
Modified at S/W Revision	A.03.00

Include S-SS

Includes the Secondary Synchronization Channel in the results.

Key Path	Meas Setup, Chan Profile Setup
Mode	LTE, LTETDD
Remote Command	[:SENSe] :EVM:DLINk:PROFile:SSS INCLude EXCLude [:SENSe] :EVM:DLINk:PROFile:SSS?
Example	EVM:DLIN:PROF:SSS INCL EVM:DLIN:PROF:SSS?
Couplings	This parameter is set to Include when Downlink Include All is selected and set to Exclude when Downlink Exclude All is selected.
Preset	INCLude
State Saved	Saved in instrument state.
Range	Include Exclude
Initial S/W Revision	Prior to A.02.00
Modified at S/W Revision	A.03.00

Include PBCH

Includes PBCH in the results.

Key Path	Meas Setup, Chan Profile Setup
Mode	LTE, LTETDD

Remote Command	[:SENSe]:EVM:DLINk:PROFile:PBCH INCLude EXCLude [:SENSe]:EVM:DLINk:PROFile:PBCH?
Example	EVM:DLIN:PROF:PBCH INCL EVM:DLIN:PROF:PBCH?
Couplings	This parameter is set to Include when Downlink Include All is selected and set to Exclude when Downlink Exclude All is selected.
Preset	INCLude
State Saved	Saved in instrument state.
Range	Include Exclude
Initial S/W Revision	Prior to A.02.00
Modified at S/W Revision	A.03.00

Include PCFICH

Includes PCFICH in the results.

Key Path	Meas Setup, Chan Profile Setup, More
Mode	LTE, LTETDD
Remote Command	[:SENSe]:EVM:DLINk:PROFile:PCFich INCLude EXCLude [:SENSe]:EVM:DLINk:PROFile:PCFich?
Example	EVM:DLIN:PROF:PCF INCL EVM:DLIN:PROF:PCF?
Couplings	This parameter is set to Include when Downlink Include All is selected and set to Exclude when Downlink Exclude All is selected.
Preset	INCLude
State Saved	Saved in instrument state.
Range	Include Exclude
Initial S/W Revision	Prior to A.02.00
Modified at S/W Revision	A.03.00

Include PHICH

Includes PHICH in the results.

Key Path	Meas Setup, Chan Profile Setup, More
Mode	LTE, LTETDD

LTE Modulation Analysis Measurement
Meas Setup (Measurement Setup)

Remote Command	[:SENSE]:EVM:DLINK:PROF:PHIC INCLude EXCLude [:SENSE]:EVM:DLINK:PROF:PHIC?
Example	EVM:DLIN:PROF:PHIC INCL EVM:DLIN:PROF:PHIC?
Couplings	This parameter is set to Include when Downlink Include All is selected and set to Exclude when Downlink Exclude All is selected.
Preset	INCLude
State Saved	Saved in instrument state.
Range	Include Exclude
Initial S/W Revision	Prior to A.02.00
Modified at S/W Revision	A.03.00

Include RS

Includes RS in the results.

Key Path	Meas Setup, Chan Profile Setup, More
Mode	LTE, LTETDD
Remote Command	[:SENSE]:EVM:DLINK:PROF:RS INCLude EXCLude [:SENSE]:EVM:DLINK:PROF:RS?
Example	EVM:DLIN:PROF:RS INCL EVM:DLIN:PROF:RS?
Couplings	This parameter is set to Include when Downlink Include All is selected and set to Exclude when Downlink Exclude All is selected.
Preset	INCLude
State Saved	Saved in instrument state.
Range	Include Exclude
Initial S/W Revision	Prior to A.02.00
Modified at S/W Revision	A.03.00

Include PDCCH

Includes PDCCH in the results.

Key Path	Meas Setup, Chan Profile Setup, More
Mode	LTE, LTETDD

Remote Command	[:SENSE]:EVM:DLINK:PROFile:PDCCCh INCLude EXCLude [:SENSE]:EVM:DLINK:PROFile:PDCCCh?
Example	EVM:DLIN:PROF:PDCC INCL EVM:DLIN:PROF:PDCC?
Couplings	This parameter is set to Include when Downlink Include All is selected and set to Exclude when Downlink Exclude All is selected.
Preset	INCLude
State Saved	Saved in instrument state.
Range	Include Exclude
Initial S/W Revision	Prior to A.02.00
Modified at S/W Revision	A.03.00

Include Non Allocation

Includes the inactive signals in the results.

Key Path	Meas Setup, Chan Profile Setup, More
Mode	LTE, LTETDD
Remote Command	[:SENSe]:EVM:PROFile:NALLocation INCLude EXCLude [:SENSe]:EVM:PROFile:NALLocation?
Example	EVM:PROF:NALL EXCL EVM:PROF:NALL?
Couplings	This parameter is same for Downlink and Uplink When either Downlink Exclude All or Uplink Exclude All is selected, this parameter is set to Exclude.
Preset	EXCLude
State Saved	Saved in instrument state.
Range	Include Exclude
Initial S/W Revision	Prior to A.02.00
Modified at S/W Revision	A.03.00

Include Users (Downlink)

Displays a menu that enables you to determine which PDSCH channels should be included in the results.

When set to Include, the corresponding user mapping is displayed on appropriate traces. When set to Exclude, only the Frame Summary trace will display the user mapping.

Key Path	Meas Setup, Chan Profile Setup, More
----------	---

LTE Modulation Analysis Measurement
Meas Setup (Measurement Setup)

Mode	LTE, LTETDD
Initial S/W Revision	Prior to A.02.00
Modified at S/W Revision	A.03.00

User

Indexes the currently defined Users.

Key Path	Meas Setup, Chan Profile Setup, Include Users
Mode	LTE, LTETDD
Dependencies	Available when Detection is Manual. You need to set allocations to the user in advance. Otherwise, this key is grayed out.
Couplings	Max value determined by the number of Users the user has configured
Preset	0
State Saved	Saved in instrument state.
Min	1
Max	Determined by the number of Users the user has configured
Initial S/W Revision	Prior to A.02.00
Modified at S/W Revision	A.03.00

Include PDSCH

Includes the user defined channel PDSCH in the results.

Key Path	Meas Setup, Chan Profile Setup, Include Users
Mode	LTE, LTETDD
Remote Command	[:SENSe] :EVM:DLINK:PROF:USER<n>:PDSch INCLude EXCLude [:SENSe] :EVM:DLINK:PROF:USER<n>:PDSch?
Example	EVM:DLIN:PROF:USER1:PDSC EXCL EVM:DLIN:PROF:USER1:PDSC?
Dependencies	The range of sub op code <n> values is determined by the number of Users the user has configured. If the user attempts to remotely set or query a sub op code that is out of range, this will result in an error message. Available when Detection is Manual. You need to set allocations to the user in advance. Otherwise, this key is grayed out.
Couplings	This parameter is set to Include when Downlink Include All is selected and set to Exclude when Downlink Exclude All is selected.
Preset	EXCLude

State Saved	Saved in instrument state.
Range	Include Exclude
Initial S/W Revision	Prior to A.02.00
Modified at S/W Revision	A.03.00

Include Decoded PDSCH

Includes the user defined channel Decoded PDSCH in the results.

Key Path	Meas Setup, Chan Profile Setup, Include Users
Mode	LTE, LTETDD
Remote Command	[:SENSE] :EVM:DLINK:PROFile:USER<n>:DECoded:PDSCh INCLude EXCLude [:SENSE] :EVM:DLINK:PROFile:USER<n>:DECoded:PDSCh?
Example	EVM:DLIN:PROF:USER1:DEC:PDSC EXCL EVM:DLIN:PROF:USER1:DEC:PDSC?
Dependencies	The range of sub op code <n> values is determined by the Number of Expected DL Users the user has configured. If the user attempts to remotely set or query a sub op code that is out of range, this will result in an error message. Available When Detection is Auto, RB Auto Detect Mode is Decoded PDCCH, User and Decoded PDSCH are available.
Couplings	This parameter is set to Include when Downlink Include All is selected, and set to Exclude when Downlink Exclude All is selected.
Preset	INCLUDE
State Saved	Saved in instrument state.
Range	Include Exclude
Initial S/W Revision	A.06.00

Include QPSK

Includes channels using QPSK Mod Type in the results.

Key Path	Meas Setup, Chan Profile Setup, Include Users
Mode	LTE, LTETDD
Remote Command	[:SENSe] :EVM:DLINK:PROFile:QPSK INCLude EXCLude [:SENSe] :EVM:DLINK:PROFile:QPSK?
Example	EVM:DLIN:PROF:QPSK INCL EVM:DLIN:PROF:QPSK?

LTE Modulation Analysis Measurement
Meas Setup (Measurement Setup)

Dependencies	Enabled when PDSCH Detection is Auto.
Couplings	This parameter is set to Include when Downlink Include All is selected and set to Exclude when Downlink Exclude All is selected.
Preset	INCLude
State Saved	Saved in instrument state.
Range	Include Exclude
Initial S/W Revision	Prior to A.02.00
Modified at S/W Revision	A.03.00

Include 16QAM

Includes channels using 16QAM Mod Type in the results.

Key Path	Meas Setup, Chan Profile Setup, Include Users
Mode	LTE, LTETDD
Remote Command	[:SENSe] :EVM:DLINk:PROFile:QAM16 INCLude EXCLude [:SENSe] :EVM:DLINk:PROFile:QAM16?
Example	EVM:DLIN:PROF:QAM16 INCL EVM:DLIN:PROF:QAM16?
Dependencies	Enabled when PDSCH Detection is Auto.
Couplings	This parameter is set to Include when Downlink Include All is selected and set to Exclude when Downlink Exclude All is selected.
Preset	INCLude
State Saved	Saved in instrument state.
Range	Include Exclude
Initial S/W Revision	Prior to A.02.00
Modified at S/W Revision	A.03.00

Include 64QAM

Includes channels using 64QAM Mod Type in the results.

Key Path	Meas Setup, Chan Profile Setup, Include Users
Mode	LTE, LTETDD
Remote Command	[:SENSe] :EVM:DLINk:PROFile:QAM64 INCLude EXCLude [:SENSe] :EVM:DLINk:PROFile:QAM64?

Example	EVM:DLIN:PROF:QAM64 INCL EVM:DLIN:PROF:QAM64?
Dependencies	Enabled when Downlink Detection is Auto.
Couplings	This parameter is set to Include when Downlink Include All is selected and set to Exclude when Downlink Exclude All is selected.
Preset	INCLude
State Saved	Saved in instrument state.
Range	Include Exclude
Initial S/W Revision	Prior to A.02.00
Modified at S/W Revision	A.03.00

Edit Control Channels

Displays a dialog that enables you to edit the Downlink Control Channel parameters. When a parameter is selected, the corresponding softkeys will appear.

You can set the Power Boost parameter for P-SS, S-SS, PBCH, PCFICH, RS, PDCCH, and PHICH. There are also several other PDCCH and PHICH parameters.

Power Boost specifies the expected average subcarrier power of a channel. When there are multiple antenna ports, the Power Boost value is split equally over all antenna ports.

For example, PBCH Power Boost is set to 0 dB. For a single-antenna signal, the expected average subcarrier power of PBCH would be 0 dB, but for a two-antenna signal, the expected average subcarrier power of PBCH per antenna port would be –3 dB.

This is done so that specifying a channel's Power Boost parameter is like specifying the average power of the channel being transmitted from the base station regardless of the number of transmit antennas.

NOTE When P-SS/S-SS Antenna Port is set to Port 0–3, the P-SS/S-SS Power Boost parameter specifies the expected average subcarrier power of P-SS/S-SS on the specified antenna port (in other words, the value is not split across all antenna ports). However, when P-SS/S-SS Antenna Port is set to All Port, then the Power Boost value is split across all antenna ports like the other channels.

Other power boost parameters are expressed relative to the 0 dB level set by RS Power Boost. A value of 2.5 dB for RS Power Boost specifies that the 0 dB level is set to be 2.5 dB below the measured RS power level.

For example, setting PBCH Power Boost to 0.5 dB for a single-antenna signal when RS Power Boost is set to 2.5 dB tells the demodulator to expect the PBCH power level to be 0.5 dB above the 0 dB level (which is 2.0 dB below the measured RS power level).

Use **Tab** key to select a parameter field to edit. The rotary knob can be also used to select a parameter field as it has two functions: value adjustment (default) and field navigation. Use **Enter** key to toggle the function.

LTE Modulation Analysis Measurement
Meas Setup (Measurement Setup)

In order to apply or discard changes, select OK button or Cancel button on the editor to show the corresponding softkeys and press either of them. These softkeys also appear by pressing **Cancel (Esc)** key when the active function is disabled.

NOTE If Help is open when you select this key, the dialog and menu does not appear. Close Help by pressing **Cancel (Esc)**, then select this key. After the menu has changed, press the green **Help** key to see Help for the dialog and keys. Close Help when you are ready to edit the parameters.

Key Path	Meas Setup, Chan Profile Setup, More, More
Mode	LTE, LTETDD
Initial S/W Revision	Prior to A.02.00
Modified at S/W Revision	A.03.00

P-SS Power Boost

Sets the Power Boost value for the P-SS.

Key Path	Meas Setup, Chan Profile Setup, Edit Control Channels, P-SS
Mode	LTE, LTETDD
Remote Command	[:SENSE] :EVM:DLINK:PROFile:PSS:PWRBoost <rel_ampl> [:SENSE] :EVM:DLINK:PROFile:PSS:PWRBoost?
Example	EVM:DLIN:PROF:PSS:PWRB 0.65 EVM:DLIN:PROF:PSS:PWRB?
Notes	Changes to this parameter willChanges to this parameter will not be applied until Update Changes command is sent. See “RB Parameter Manager (Downlink)” on page 970 section for more details.
Preset	0 dB
State Saved	Saved in instrument state.
Min	-100 dB
Max	100 dB
Initial S/W Revision	Prior to A.02.00
Modified at S/W Revision	A.03.00, A.04.20

S-SS Power Boost

Sets the Power Boost value for the S-SS.

Key Path	Meas Setup, Chan Profile Setup, Edit Control Channels, S-SS
Mode	LTE, LTETDD
Remote Command	[:SENSe]:EVM:DLINk:PROFile:SSS:PWRBoost <rel_ampl> [:SENSe]:EVM:DLINk:PROFile:SSS:PWRBoost?
Example	EVM:DLIN:PROF:SSS:PWRB 0.65 EVM:DLIN:PROF:SSS:PWRB?
Notes	Changes to this parameter will not be applied until Update Changes command is sent. See “RB Parameter Manager (Downlink)” on page 970 section for more details.
Preset	0 dB
State Saved	Saved in instrument state.
Min	-100 dB
Max	100 dB
Initial S/W Revision	Prior to A.02.00
Modified at S/W Revision	A.03.00, A.04.20

PBCH Power Boost

Sets the Power Boost value for the PBCH.

Key Path	Meas Setup, Chan Profile Setup, Edit Control Channels, PBCH
Mode	LTE, LTETDD
Remote Command	[:SENSe]:EVM:DLINk:PROFile:PBCH:PWRBoost <rel_ampl> [:SENSe]:EVM:DLINk:PROFile:PBCH:PWRBoost?
Example	EVM:DLIN:PROF:PBCH:PWRB 0 EVM:DLIN:PROF:PBCH:PWRB?
Notes	Changes to this parameter will not be applied until Update Changes command is sent. See “RB Parameter Manager (Downlink)” on page 970 section for more details.
Preset	0 dB
State Saved	Saved in instrument state.
Min	-100 dB
Max	100 dB
Initial S/W Revision	Prior to A.02.00

Modified at S/W Revision	A.03.00, A.04.20
--------------------------	------------------

PCFICH Power Boost

Sets the Power Boost value for the PCFICH.

Key Path	Meas Setup, Chan Profile Setup, Edit Control Channels, PCFICH
Mode	LTE, LTETDD
Remote Command	[:SENSe]:EVM:DLINk:PROFile:PCFich:PWRBoost <rel_ampl> [:SENSe]:EVM:DLINk:PROFile:PCFich:PWRBoost?
Example	EVM:DLIN:PROF:PCF:PWRB 0 EVM:DLIN:PROF:PCF:PWRB?
Notes	Changes to this parameter will not be applied until Update Changes command is sent. See “RB Parameter Manager (Downlink)” on page 970 section for more details.
Preset	0 dB
State Saved	Saved in instrument state.
Min	-100 dB
Max	100 dB
Initial S/W Revision	Prior to A.02.00
Modified at S/W Revision	A.03.00, A.04.20

RS Power Boost

Sets the Power Boost value for the RS.

The 0 dB level is set by RS Power Boost. A value of 2.5 dB for RS Power Boost specifies that the 0 dB level is set to be 2.5 dB below the measured RS power level.

Other Power Boosts (P-SS, S-SS, PBCH, PCFICH, PDCCH and PHICH) are set relative to the 0 dB level. For example, setting PBCH Power Boost to 0.5 dB when RS Power Boost is set to 2.5 dB tells the demodulator to expect the average PBCH power level to be 0.5 dB above the 0 dB level (which is 2.5 dB below the measured RS power level).

Key Path	Meas Setup, Chan Profile Setup, Edit Control Channels, RS
Mode	LTE, LTETDD
Remote Command	[:SENSe]:EVM:DLINk:PROFile:RS:PWRBoost <rel_ampl> [:SENSe]:EVM:DLINk:PROFile:RS:PWRBoost?
Example	EVM:DLIN:PROF:RS:PWRB 2.50 EVM:DLIN:PROF:RS:PWRB?

Notes	Changes to this parameter will not be applied until Update Changes command is sent. See “RB Parameter Manager (Downlink)” on page 970 section for more details.
Preset	0 dB
State Saved	Saved in instrument state.
Min	-100 dB
Max	100 dB
Initial S/W Revision	Prior to A.02.00
Modified at S/W Revision	A.03.00, A.04.20

PDCCH

Displays a menu that enables the configuration of PDCCH parameters.

Key Path	Meas Setup, Chan Profile Setup, Edit Control Channels
Mode	LTE, LTETDD
Initial S/W Revision	Prior to A.02.00
Modified at S/W Revision	A.03.00

PDCCH Power Boost

Sets the Power Boost value for the PDCCH.

When RB Auto Detect Mode is set to Decoded PDCCH, PDCCH power boost (see the section Edit Control Channels for description of Power Boost parameters) can be auto detected by specifying a starting value in this parameter and setting the granularity of the search in the PDCCH Power Boost Step. The demodulator will detect PDCCH power as

$$\text{PDCCH power} = (\text{PDCCH Power Boost} + k * \text{PDCCH Power Boost Step})$$

where k in the range $-10 \text{ dB} \leq k * \text{PDCCH Power Boost Step} \leq 10 \text{ dB}$ is the value that brings the equation closest to the actual PDCCH power.

Key Path	Meas Setup, Chan Profile Setup, Edit Control Channels, PDCCH
Mode	LTE, LTETDD
Remote Command	[:SENSE]:EVM:DLINk:PROfile:PDCCh:PWRBoost <rel_ampl> [:SENSE]:EVM:DLINk:PROfile:PDCCh:PWRBoost?
Example	EVM:DLIN:PROF:PDCC:PWRB 0 EVM:DLIN:PROF:PDCC:PWRB?
Notes	Changes to this parameter will not be applied until Update Changes command is sent. See “RB Parameter Manager (Downlink)” on page 970 section for more details.
Preset	0 dB

LTE Modulation Analysis Measurement
Meas Setup (Measurement Setup)

State Saved	Saved in instrument state.
Min	-100 dB
Max	100 dB
Initial S/W Revision	Prior to A.02.00
Modified at S/W Revision	A.03.00, A.04.20

PDCCH Power Boost Step (+/- Increments (dB))

Sets the Power Boost Step value for the PDCCH. See section PDCCH Power Step for more details.

Key Path	Meas Setup, Chan Profile Setup, Edit Control Channels, PDCCH
Mode	LTE, LTETDD
Remote Command	[:SENSE]:EVM:DLINK:PROF:ile:PDCCh:PWRBoost:STEP <rel_amp1> [:SENSE]:EVM:DLINK:PROF:ile:PDCCh:PWRBoost:STEP?
Example	EVM:DLIN:PROF:PDCC:PWRB:STEP 0 EVM:DLIN:PROF:PDCC:PWRB:STEP?
Notes	Changes to this parameter will not be applied until Update Changes command is sent. See section 3.11.7.16.22 RB Parameter Manager (Downlink) for more details.
Dependencies	Available when Detection is Auto and RB Auto Detect Mode is Decoded PDCCH, or Detection is Auto and PDCCH Decoding is other than NONE.
Preset	1 dB
State Saved	Saved in instrument state.
Min	-100 dB
Max	100 dB
Initial S/W Revision	A.10.00

PDCCH Allocation Auto Detect

Determines whether or not the number of PDCCH symbols is autodetected. When On, the analyzer will autodetect the PDCCH allocations by decoding PCFICH.

To view the detected number of PDCCH allocations per subframe, use the # PDCCH SymPerSubframe data result on the DL Decode Info summary table.

Key Path	Meas Setup, Chan Profile Setup, Edit Control Channels, PDCCH Alloc
Mode	LTE, LTE TDD

Remote Command	[:SENSe]:EVM:DLINk:PROFile:PDCCCh:ALLOcation:AUTO[:DETEct] OFF ON 0 1 [:SENSe]:EVM:DLINk:PROFile:PDCCCh:ALLOcation:AUTO[:DETEct]?
Example	EVM:DLIN:PROF:PDCC:ALL:AUTO 1 EVM:DLIN:PROF:PDCC:ALL:AUTO?
Notes	Changes to this parameter will not be applied until Update Changes command is sent. See “RB Parameter Manager (Downlink)” on page 970 section for more details.
Preset	ON
State Saved	Saved in instrument state.
Range	On Off
Initial S/W Revision	A.06.00

PDCCH Allocation Constant

Selects whether or not all the Subframes will use PDCCH Allocation Subframe 0 value.

Key Path	Meas Setup, Chan Profile Setup, Edit Control Channels, PDCCH Alloc
Mode	LTE
Remote Command	[:SENSe]:EVM:DLINk:PROFile:PDCCCh:ALLOcation:CONStant OFF ON 0 1 [:SENSe]:EVM:DLINk:PROFile:PDCCCh:ALLOcation:CONStant?
Example	EVM:DLIN:PROF:PDCC:ALL:CONS ON EVM:DLIN:PROF:PDCC:ALL:CONS?
Notes	Changes to this parameter will not be applied until Update Changes command is sent. See “RB Parameter Manager (Downlink)” on page 970 section for more details.
Dependencies	LTE FDD only. Available when PDCCH Allocation Auto Detect is Off.
Couplings	When this parameter is On, all Subframes will use PDCCH Allocation Subframe 0 value.
Preset	ON
State Saved	Saved in instrument state.
Initial S/W Revision	Prior to A.02.00
Modified at S/W Revision	A.03.00

LTE Modulation Analysis Measurement
Meas Setup (Measurement Setup)

PDCCH Allocation Subframe 0

Sets the PDCCH Allocation (Symbols per Subframe) for Subframe 0.

Key Path	Meas Setup, Chan Profile Setup, Edit Control Channels, PDCCH Alloc
Mode	LTE, LTETDD
Remote Command	[:SENSe]:EVM:DLINk:PROFile:PDCCh:ALLocation:SUBFrame0:SYMBOLs <integer> [:SENSe]:EVM:DLINk:PROFile:PDCCh:ALLocation:SUBFrame0:SYMBOLs?
Example	EVM:DLIN:PROF:PDCC:ALL:SUBF0:SYMB 1 EVM:DLIN:PROF:PDCC:ALL:SUBF0:SYMB?
Notes	Changes to this parameter will not be applied until Update Changes command is sent. See “RB Parameter Manager (Downlink)” on page 970 section for more details.
Dependencies	When PDCCH Allocation Constant is On, all subframes will use this value. Available when PDCCH Allocation Auto Detect is Off.
Preset	3
State Saved	Saved in instrument state.
Min	0
Max	3 – Bandwidth 3 MHz, 5 MHz, 10 MHz, 15 MHz, 20 MHz 4 – Bandwidth 1.4 MHz
Initial S/W Revision	Prior to A.02.00
Modified at S/W Revision	A.03.00

PDCCH Allocation Subframe 1

Sets the PDCCH Allocation (Symbols per Subframe) for Subframe 1.

Key Path	Meas Setup, Chan Profile Setup, Edit Control Channels, PDCCH Alloc
Mode	LTE, LTETDD
Remote Command	[:SENSe]:EVM:DLINk:PROFile:PDCCh:ALLocation:SUBFrame1:SYMBOLs <integer> [:SENSe]:EVM:DLINk:PROFile:PDCCh:ALLocation:SUBFrame1:SYMBOLs?
Example	EVM:DLIN:PROF:PDCC:ALL:SUBF1:SYMB 1 EVM:DLIN:PROF:PDCC:ALL:SUBF1:SYMB?
Notes	Changes to this parameter will not be applied until Update Changes command is sent. See “RB Parameter Manager (Downlink)” on page 970 section for more details.

Dependencies	Available when both PDCCH Allocation Auto Detect and PDCCH Allocation Constant are OFF.
Preset	3
State Saved	Saved in instrument state.
Min	0
Max	3 – Bandwidth 3 MHz, 5 MHz, 10 MHz, 15 MHz, 20 MHz 4 – Bandwidth 1.4 MHz
Initial S/W Revision	Prior to A.02.00
Modified at S/W Revision	A.03.00

PDCCH Allocation Subframe 2

Sets the PDCCH Allocation (Symbols per Subframe) for Subframe 2.

Key Path	Meas Setup, Chan Profile Setup, Edit Control Channels, PDCCH Alloc
Mode	LTE, LTETDD
Remote Command	[:SENSe] :EVM:DLINk:PROFile:PDCCh:ALLocation:SUBFrame2:SYMBOLs <integer> [:SENSe] :EVM:DLINk:PROFile:PDCCh:ALLocation:SUBFrame2:SYMBOLs?
Example	EVM:DLIN:PROF:PDCC:ALL:SUBF2:SYMB 1 EVM:DLIN:PROF:PDCC:ALL:SUBF2:SYMB?
Notes	Changes to this parameter will not be applied until Update Changes command is sent. See “RB Parameter Manager (Downlink)” on page 970 section for more details.
Dependencies	Available when both PDCCH Allocation Auto Detect and PDCCH Allocation Constant are OFF.
Preset	3
State Saved	Saved in instrument state.
Min	0
Max	3 – Bandwidth 3 MHz, 5 MHz, 10 MHz, 15 MHz, 20 MHz 4 – Bandwidth 1.4 MHz
Initial S/W Revision	Prior to A.02.00
Modified at S/W Revision	A.03.00

LTE Modulation Analysis Measurement
Meas Setup (Measurement Setup)

PDCCH Allocation Subframe 3

Sets the PDCCH Allocation (Symbols per Subframe) for Subframe 3.

Key Path	Meas Setup, Chan Profile Setup, Edit Control Channels, PDCCH Alloc
Mode	LTE, LTETDD
Remote Command	[:SENSe]:EVM:DLINk:PROFile:PDCCh:ALLocation:SUBFrame3:SYMBOLs <integer> [:SENSe]:EVM:DLINk:PROFile:PDCCh:ALLocation:SUBFrame3:SYMBOLs?
Example	EVM:DLIN:PROF:PDCC:ALL:SUBF3:SYMB 1 EVM:DLIN:PROF:PDCC:ALL:SUBF3:SYMB?
Notes	Changes to this parameter will not be applied until Update Changes command is sent. See “RB Parameter Manager (Downlink)” on page 970 section for more details.
Dependencies	Available when both PDCCH Allocation Auto Detect and PDCCH Allocation Constant are OFF.
Preset	3
State Saved	Saved in instrument state.
Min	0
Max	3 – Bandwidth 3 MHz, 5 MHz, 10 MHz, 15 MHz, 20 MHz 4 – Bandwidth 1.4 MHz
Initial S/W Revision	Prior to A.02.00
Modified at S/W Revision	A.03.00

PDCCH Allocation Subframe 4

Sets the PDCCH Allocation (Symbols per Subframe) for Subframe 4.

Key Path	Meas Setup, Chan Profile Setup, Edit Control Channels, PDCCH Alloc
Mode	LTE, LTETDD
Remote Command	[:SENSe]:EVM:DLINk:PROFile:PDCCh:ALLocation:SUBFrame4:SYMBOLs <integer> [:SENSe]:EVM:DLINk:PROFile:PDCCh:ALLocation:SUBFrame4:SYMBOLs?
Example	EVM:DLIN:PROF:PDCC:ALL:SUBF4:SYMB 1 EVM:DLIN:PROF:PDCC:ALL:SUBF4:SYMB?
Notes	Changes to this parameter will not be applied until Update Changes command is sent. See “RB Parameter Manager (Downlink)” on page 970 section for more details.

Dependencies	Available when both PDCCH Allocation Auto Detect and PDCCH Allocation Constant are OFF.
Preset	3
State Saved	Saved in instrument state.
Min	0
Max	3 – Bandwidth 3 MHz, 5 MHz, 10 MHz, 15 MHz, 20 MHz 4 – Bandwidth 1.4 MHz
Initial S/W Revision	Prior to A.02.00
Modified at S/W Revision	A.03.00

PDCCH Allocation Subframe 5

Sets the PDCCH Allocation (Symbols per Subframe) for Subframe 5.

Key Path	Meas Setup, Chan Profile Setup, Edit Control Channels, PDCCH Alloc
Mode	LTE, LTETDD
Remote Command	[:SENSe] :EVM:DLINk:PROFile:PDCCh:ALLocation:SUBFrame5:SYMBOLs <integer> [:SENSe] :EVM:DLINk:PROFile:PDCCh:ALLocation:SUBFrame5:SYMBOLs?
Example	EVM:DLIN:PROF:PDCC:ALL:SUBF5:SYMB 1 EVM:DLIN:PROF:PDCC:ALL:SUBF5:SYMB?
Notes	Changes to this parameter will not be applied until Update Changes command is sent. See “RB Parameter Manager (Downlink)” on page 970 section for more details.
Dependencies	Available when both PDCCH Allocation Auto Detect and PDCCH Allocation Constant are OFF.
Preset	3
State Saved	Saved in instrument state.
Min	0
Max	3 – Bandwidth 3 MHz, 5 MHz, 10 MHz, 15 MHz, 20 MHz 4 – Bandwidth 1.4 MHz
Initial S/W Revision	Prior to A.02.00
Modified at S/W Revision	A.03.00

LTE Modulation Analysis Measurement
Meas Setup (Measurement Setup)

PDCCH Allocation Subframe 6

Sets the PDCCH Allocation (Symbols per Subframe) for Subframe 6.

Key Path	Meas Setup, Chan Profile Setup, Edit Control Channels, PDCCH Alloc
Mode	LTE, LTETDD
Remote Command	[:SENSe]:EVM:DLINk:PROFile:PDCCh:ALLocation:SUBFrame6:SYMBOLs <integer> [:SENSe]:EVM:DLINk:PROFile:PDCCh:ALLocation:SUBFrame6:SYMBOLs?
Example	EVM:DLIN:PROF:PDCC:ALL:SUBF6:SYMB 1 EVM:DLIN:PROF:PDCC:ALL:SUBF6:SYMB?
Notes	Changes to this parameter will not be applied until Update Changes command is sent. See “RB Parameter Manager (Downlink)” on page 970 section for more details.
Dependencies	Available when both PDCCH Allocation Auto Detect and PDCCH Allocation Constant are OFF.
Preset	3
State Saved	Saved in instrument state.
Min	0
Max	3 – Bandwidth 3 MHz, 5 MHz, 10 MHz, 15 MHz, 20 MHz 4 – Bandwidth 1.4 MHz
Initial S/W Revision	Prior to A.02.00
Modified at S/W Revision	A.03.00

PDCCH Allocation Subframe 7

Sets the PDCCH Allocation (Symbols per Subframe) for Subframe 7.

Key Path	Meas Setup, Chan Profile Setup, Edit Control Channels, PDCCH Alloc
Mode	LTE, LTETDD
Remote Command	[:SENSe]:EVM:DLINk:PROFile:PDCCh:ALLocation:SUBFrame7:SYMBOLs <integer> [:SENSe]:EVM:DLINk:PROFile:PDCCh:ALLocation:SUBFrame7:SYMBOLs?
Example	EVM:DLIN:PROF:PDCC:ALL:SUBF7:SYMB 1 EVM:DLIN:PROF:PDCC:ALL:SUBF7:SYMB?
Notes	Changes to this parameter will not be applied until Update Changes command is sent. See “RB Parameter Manager (Downlink)” on page 970 section for more details.

Dependencies	Available when both PDCCH Allocation Auto Detect and PDCCH Allocation Constant are OFF.
Preset	3
State Saved	Saved in instrument state.
Min	0
Max	3 – Bandwidth 3 MHz, 5 MHz, 10 MHz, 15 MHz, 20 MHz 4 – Bandwidth 1.4 MHz
Initial S/W Revision	Prior to A.02.00
Modified at S/W Revision	A.03.00

PDCCH Allocation Subframe 8

Sets the PDCCH Allocation (Symbols per Subframe) for Subframe 8.

Key Path	Meas Setup, Chan Profile Setup, Edit Control Channels, PDCCH Alloc
Mode	LTE, LTETDD
Remote Command	[:SENSe] :EVM:DLINk:PROFile:PDCCh:ALLocation:SUBFrame8:SYMBOLs <integer> [:SENSe] :EVM:DLINk:PROFile:PDCCh:ALLocation:SUBFrame8:SYMBOLs?
Example	EVM:DLIN:PROF:PDCC:ALL:SUBF8:SYMB 1 EVM:DLIN:PROF:PDCC:ALL:SUBF8:SYMB?
Notes	Changes to this parameter will not be applied until Update Changes command is sent. See “RB Parameter Manager (Downlink)” on page 970 section for more details.
Dependencies	Available when both PDCCH Allocation Auto Detect and PDCCH Allocation Constant are OFF.
Preset	3
State Saved	Saved in instrument state.
Min	0
Max	3 – Bandwidth 3 MHz, 5 MHz, 10 MHz, 15 MHz, 20 MHz 4 – Bandwidth 1.4 MHz
Initial S/W Revision	Prior to A.02.00
Modified at S/W Revision	A.03.00

PDCCH Allocation Subframe 9

Sets the PDCCH Allocation (Symbols per Subframe) for Subframe 9.

Key Path	Meas Setup, Chan Profile Setup, Edit Control Channels, PDCCH Alloc
Mode	LTE, LTETDD
Remote Command	[:SENSe]:EVM:DLINk:PROFile:PDCCh:ALLocation:SUBFrame9:SYMBOLs <integer> [:SENSe]:EVM:DLINk:PROFile:PDCCh:ALLocation:SUBFrame9:SYMBOLs?
Example	EVM:DLIN:PROF:PDCC:ALL:SUBF9:SYMB 1 EVM:DLIN:PROF:PDCC:ALL:SUBF9:SYMB?
Notes	Changes to this parameter will not be applied until Update Changes command is sent. See “RB Parameter Manager (Downlink)” on page 970 section for more details.
Dependencies	Available when both PDCCH Allocation Auto Detect and PDCCH Allocation Constant are OFF.
Preset	3
State Saved	Saved in instrument state.
Min	0
Max	3 – Bandwidth 3 MHz, 5 MHz, 10 MHz, 15 MHz, 20 MHz 4 – Bandwidth 1.4 MHz
Initial S/W Revision	Prior to A.02.00
Modified at S/W Revision	A.03.00

PHICH

Displays a menu that enables configuration of PHICH parameters.

Key Path	Meas Setup, Chan Profile Setup, Edit Control Channels
Mode	LTE, LTETDD
Initial S/W Revision	Prior to A.02.00
Modified at S/W Revision	A.03.00

PHICH Power Boost

Sets the Power Boost value for the PHICH.

PHICH power boost (See section Edit Control Channels for description of Power Boost parameters) can be auto detected by specifying a starting value in this parameter and setting the granularity of the search in the PHICH Power Boost Step. The demodulator will detect PHICH power as

$$\text{PHICH power} = (\text{PHICH Power Boost} + k * \text{PHICH Power Boost Step})$$

where k in the range $-10 \text{ dB} \leq k \text{ PHICH Power Boost Step} \leq 10 \text{ dB}$ is the value that brings the equation closest to the actual PHICH power.

Key Path	Meas Setup, Chan Profile Setup, Edit Control Channels, PHICH
Mode	LTE, LTETDD
Remote Command	[:SENSe]:EVM:DLINk:PROfile:PHICh:PWRBoost <rel_ampl> [:SENSe]:EVM:DLINk:PROfile:PHICh:PWRBoost?
Example	EVM:DLIN:PROF:PHIC:PWRB 0 EVM:DLIN:PROF:PHIC:PWRB?
Notes	Changes to this parameter will not be applied until Update Changes command is sent. See “RB Parameter Manager (Downlink)” on page 970 section for more details.
Preset	0 dB
State Saved	Saved in instrument state.
Min	-100 dB
Max	100 dB
Initial S/W Revision	Prior to A.02.00
Modified at S/W Revision	A.03.00
Modified at S/W Revision	A.04.20

PHICH Power Boost Step (+/- Increments (dB))

Sets the Power Boost Step value for the PHICH. See [“PHICH Power Boost”](#) on page 910 for details.

Key Path	Meas Setup, Chan Profile Setup, Edit Control Channels, PHICH
Mode	LTE, LTETDD
Remote Command	[:SENSe]:EVM:DLINk:PROfile:PHICh:PWRBoost:STEP <rel_ampl>+ [:SENSe]:EVM:DLINk:PROfile:PHICh:PWRBoost:STEP?
Example	EVM:DLIN:PROF:PHIC:PWRB:STEP 0 EVM:DLIN:PROF:PHIC:PWRB:STEP?
Notes	Changes to this parameter will not be applied until Update Changes command is sent. See “RB Parameter Manager (Downlink)” on page 970 section for more details.
Preset	1 dB
State Saved	Saved in instrument state.
Min	-100 dB
Max	100 dB

LTE Modulation Analysis Measurement
Meas Setup (Measurement Setup)

Initial S/W Revision	A.03.00, A.04.20
----------------------	------------------

Despread IQ Orthogonal Sequence Index

Determines the state of Despread IQ Orthogonal Sequence Index.

When set to OFF, displays the PHICH constellation points as received, which is the summation of all PHICHs within the same PHICH group.

When set to ON, the traces to display PHICH constellation points after despreading. Despreading arbitrarily remaps the demodulated values of individual PHICH sequences onto the I and Q values of the subcarriers containing those sequences. Only the IQ Meas and IQ Ref traces are affected when this parameter is selected. EVM measurements are always calculated from PHICH IQ points before despreading.

Each PHICH can take on values in the set $\{-1, 0, 1\}$ which is translated as {NACK, Inactive, ACK}.

PHICH mapping for Normal CP Length		
Subcarrier in a PHICH group	Re{Subcarrier x} value	Imag{Subcarrier x} value
Subcarrier 0	PHICH0	PHICH4
Subcarrier 1	PHICH1	PHICH5
Subcarrier 2	PHICH2	PHICH6
Subcarrier 3	PHICH3	PHICH7

PHICH mapping for Extended CP Length		
Subcarrier in a PHICH group	Re{Subcarrier x} value	Imag{Subcarrier x} value
Subcarrier 0	PHICH0	PHICH2
Subcarrier 1	PHICH1	PHICH3

Each PHICH subcarrier IQ point represents the values for the two PHICHs determined by the tables above. A PHICH group shows up three times in a PHICH subframe, each time with different values for the PHICH sequences. The image below provides a quick reference to the actual PHICH values for each constellation point in the form (I,Q).

Key Path	Meas Setup, Chan Profile Setup, Edit Control Channels, PHICH
Mode	LTE, LTETDD
Remote Command	[:SENSE] :EVM:DLINK:PROF:PHICH:DESPread OFF ON 0 1 [:SENSE] :EVM:DLINK:PROF:PHICH:DESPread?
Example	EVM:DLIN:PROF:PHIC:DESP OFF EVM:DLIN:PROF:PHIC:DESP?

Notes	Changes to this parameter will not be applied until Update Changes command is sent. See “RB Parameter Manager (Downlink)” on page 970 section for more details.
Preset	OFF
State Saved	Saved in instrument state.
Initial S/W Revision	Prior to A.02.00
Modified at S/W Revision	A.03.00

PHICH Allocation (Ng)

Selects the Ng value used in computing the number of resource element groups. Allocation (Ng) is a higher layer parameter configured from the set (1/6, 1/2, 1, 2) that determines the number of PHICH groups per subframe.

- ADETect - Allocation (Ng) will be detected from PBCH.
- R1BY6 - Ng = 1/6
- R1BY2 - Ng = 1/2
- R1 - Ng = 1
- R2 - Ng = 2

The number of PHICH groups in a subframe is given by the equation for N_{PHICH}^{group} in Section 6.9 of 3GPP TS 36.211.

Key Path	Meas Setup, Chan Profile Setup, Edit Control Channels, PHICH Allocation
Mode	LTE, LTETDD
Remote Command	[:SENSE] :EVM:DLINK:PROfile:PHICH:ALlocation:RATio ADETect R1BY6 R1BY2 R1 R2 [:SENSE] :EVM:DLINK:PROfile:PHICH:ALlocation:RATio?
Example	EVM:DLIN:PROF:PHIC:ALL:RAT R1 EVM:DLIN:PROF:PHIC:ALL:RAT?
Notes	Changes to this parameter will not be applied until Update Changes command is sent. See “RB Parameter Manager (Downlink)” on page 970 section for more details.
Dependencies	Available when Direction is Downlink.
Preset	ADETect
State Saved	Saved in instrument state.
Range	Auto Detect Ng 1/6 Ng 1/2 Ng 1 Ng 2
Initial S/W Revision	Prior to A.02.00
Modified at S/W Revision	A.03.00, A.06.00

LTE Modulation Analysis Measurement
Meas Setup (Measurement Setup)

Auto Detect

When Auto Detect is selected, Allocation (Ng) will be detected from PBCH.

Key Path	Meas Setup, Chan Profile Setup, Edit Control Channels, PHICH Allocation
Mode	LTE, LTETDD
Initial S/W Revision	A.06.00

Ng 1/6

Selects 1/6 for the Ng value used in computing the number of resource element groups.

Key Path	Meas Setup, Chan Profile Setup, Edit Control Channels, PHICH Allocation
Mode	LTE, LTETDD
Initial S/W Revision	Prior to A.02.00
Modified at S/W Revision	A.03.00

Ng 1/2

Selects 1/2 for the Ng value used in computing the number of resource element groups.

Key Path	Meas Setup, Chan Profile Setup, Edit Control Channels, PHICH Allocation
Mode	LTE, LTETDD
Initial S/W Revision	Prior to A.02.00
Modified at S/W Revision	A.03.00

Ng 1

Selects 1 for the Ng value used in computing the number of resource element groups.

Key Path	Meas Setup, Chan Profile Setup, Edit Control Channels, PHICH Allocation
Mode	LTE, LTETDD
Initial S/W Revision	Prior to A.02.00
Modified at S/W Revision	A.03.00

Ng 2

Selects 2 for the Ng value used in computing the number of resource element groups.

Key Path	Meas Setup, Chan Profile Setup, Edit Control Channels, PHICH Allocation
Mode	LTE, LTETDD
Initial S/W Revision	Prior to A.02.00
Modified at S/W Revision	A.03.00

PHICH Duration

Selects the number of symbols used in each PHICH subframe.

PHICH duration is a higher layer parameter configured either as Normal or Extended that tells the demodulator how many symbols per subframe are used by PHICH.

- ADEtect - PHICH Duration can be autodetected from PBCH
- NORMal - There are 8 PHICH sequences in one PHICH group
- EXTended - There are 4 PHICH sequences in one PHICH group

Key Path	Meas Setup, Chan Profile Setup, Edit Control Channels, PHICH Duration
Mode	LTE, LTETDD
Remote Command	[:SENSE] :EVM:DLINK:PROFile:PHICH:DURation ADEtect NORMal EXTended [:SENSE] :EVM:DLINK:PROFile:PHICH:DURation?
Example	EVM:DLIN:PROF:PHIC:DUR NORM EVM:DLIN:PROF:PHIC:DUR?
Notes	Changes to this parameter will not be applied until Update Changes command is sent. See “ RB Parameter Manager (Downlink) ” on page 970 section for more details.
Dependencies	Available when Direction is Downlink.
Preset	ADEtect
State Saved	Saved in instrument state.
Range	Auto Detect Normal Extended
Initial S/W Revision	Prior to A.02.00
Modified at S/W Revision	A.03.00, A.06.00

Auto Detect

When Auto Detect is selected, PHICH Duration can be autodetected from PBCH

Key Path	Meas Setup, Chan Profile Setup, Edit Control Channels, PHICH Duration
Mode	LTE, LTETDD
Initial S/W Revision	A.06.00

Normal

Selects Normal for the PHICH duration.

Key Path	Meas Setup, Chan Profile Setup, Edit Control Channels, PHICH Duration
Mode	LTE, LTETDD

LTE Modulation Analysis Measurement
Meas Setup (Measurement Setup)

Initial S/W Revision	Prior to A.02.00
Modified at S/W Revision	A.03.00

Extended

Selects Extended for the PHICH duration.

Key Path	Meas Setup, Chan Profile Setup, Edit Control Channels, PHICH Duration
Mode	LTE, LTETDD
Initial S/W Revision	Prior to A.02.00
Modified at S/W Revision	A.03.00

Mi Definition

Selects which specification the factor M_i is set to. The factor M_i is originally defined in 3GPP TS36.211 Table 6.9–1 and it is used to specify the number of PHICH groups which may vary between downlink subframes.

The M_i parameter determines how many PHICH groups are in each downlink subframe for TDD mode. The values for M_i depend on the uplink-downlink configuration and are given by Table 6.9–1 in 3GPP TS 36.211. However, 3GPP TS 36.141, section 6.1.2.6 specifies that M_i must be set to 1 when performing E-TM tests. This is to provide consistency between FDD and TDD test results.

- STD - Standard, the expected values of M_i are given by Table 6.9–1 in 3GPP TS36.211
- ETM - E-TM, M_i is expected to equal 1 in all downlink subframes

Key Path	Meas Setup, Chan Profile Setup, Edit Control Channels, Mi Definition
Mode	LTETDD
Remote Command	[:SENSE]:EVM:DLINK:PROFile:PHICH:MIDefinition STD ETM [:SENSE]:EVM:DLINK:PROFile:PHICH:MIDefinition?
Example	EVM:DLIN:PROF:PHIC:MID STD
Notes	LTE TDD only. Changes to this parameter will not be applied until Update Changes command is sent. See “RB Parameter Manager (Downlink)” on page 970 section for more details.
Dependencies	Available when Direction is Downlink. LTE TDD only.
Preset	STD
State Saved	Saved in instrument state.
Range	Standard E-TM
Initial S/W Revision	A.06.00

Edit User Mapping (Downlink)

Displays the LTE Allocation Editor that enables you to edit the Downlink channel parameters. When a parameter is selected, the corresponding softkeys will appear.

Use **Tab** key to select a parameter field to edit. The rotary knob can be also used to select a parameter field as it has two functions: value adjustment (default) and field navigation. Use **Enter** key to toggle the function.

In order to apply or discard changes, select OK button or Cancel button on the editor to show the corresponding softkeys and press either of them. These softkeys also appear by pressing **Cancel (Esc)** key when the active function is disabled.

NOTE If Help is open when you select this key, the dialog and menu does not appear. Close Help by pressing **Cancel (Esc)**, then select this key. After the menu has changed, press the green **Help** key to see Help for the dialog and keys. Close Help when you are ready to edit the parameters.

Key Path	Meas Setup, Chan Profile Setup
Mode	LTE, LTETDD
Initial S/W Revision	Prior to A.02.00
Modified at S/W Revision	A.03.00, A.06.00

This table lists all the parameters available to set up downlink PDSCH user allocations.

Parameter	Description
Detection	When Auto, the demodulator will autodetect PDSCH user allocations. The only parameter needed is Power Boost (for EVM calculations). RB Autodetect groups resource blocks that contain the same modulation type into a user so that there are three possible users: QPSK, QAM16, and QAM64.
RB Auto Detect Mode	Specifies how the LTE demodulator detects user allocations when Detection is Auto.
Auto Detect Power Levels	Selects whether or not power levels are autodetected. Enabled only when RB Auto Detect is On and RB Auto Detect Mode is Decoded PDCCH.
Round to Standard Value	Determines whether the measured, relative power levels for PDSCH allocations are detected as one of the standard values or assumed to be equal to the measured power level.
Multi-Frame Analysis	When On, the demodulator enables user to setup PDSCH allocations for two continuous frames. This parameter needs to be set to On when the signal under analysis is complied with E-UTRA TDD Test Models defined in 3GPP TS36.141 6.1.1 V8.2.0.
Show Mapping	Specifies which frame's allocation will be shown in RB Mapping diagram when Multi-Frame Analysis is On.

LTE Modulation Analysis Measurement
Meas Setup (Measurement Setup)

Include	When this check box is selected, the corresponding user mapping is displayed on appropriate traces. When cleared, only the Frame Summary trace will display the user mapping.
Add	Adds a user mapping.
Delete	Deletes the selected user mapping.
RNTI	Sets the radio network temporary identifier for the user. Enabled only when Detection is manual. (TDD only)
UE-RS Active	Selects whether the UE-specific reference signal is present in the signal under test. Enabled only when Detection is manual. (TDD only)
UE-RS Include	Selects whether the UE-specific reference signal is included in the analysis results. Enabled only when UE-RS Active is On and Detection is manual. (TDD only)
UE-RS Power	Specifies the power boost for the UE-specific reference signal. Enabled only when Detection is manual. (TDD only)
UE-RS Port	Specifies on which logical antenna port UE-RS is transmitted for the selected PDSCH user allocation. (TDD only)
UE-RS nSCID	Specifies downlink user's scrambling identity value nSCID(TDD only)
Precoding Parameters	
Precoding	Specifies the type of shared channel precoding method that the demodulator should expect.
Number of layers	Specifies the number of layers. It's less than or equal to the number of antenna ports used for transmission of the physical channel.
Number of codewords	Specifies the number of codewords.
CDD	Specifies whether precoding will be done with or without CDD (cyclic delay diversity) for spatial multiplexing.
Codebook Index	Specifies the Codebook index for spatial multiplexing precoding.
PDSCH Per-allocation Parameters	
Couple	Certain parameters can be coupled across all RB allocation groups for a user or can be set independently for each RB allocation group. Selecting the checkbox next to a parameter will couple that parameter across all RB allocation groups.
RB Start	Specifies the RB start boundary of the current allocation group for the current user.
RB End	Specifies the RB end boundary of the current allocation group for the current user.
Slot Start	Specifies the slot start boundary of the current allocation group for the current user.
Slot End	Specifies the slot end boundary of the current allocation group for the current user.

Codeword 0 Mod Type	Modulation type for codeword 0: QPSK, QAM16, or QAM64.
Codeword 1 Mod Type	Modulation type for codeword 1: QPSK, QAM16, or QAM64.
Codeword 0 Power Boost	The power of the subcarriers relative to the 0 dB level determined by the RS power level for codeword 0. See “ Chan Profile Setup (Downlink) ” on page 884 for more information.
Codeword 1 Power Boost	The power of the subcarriers relative to the 0 dB level determined by the RS power level for codeword 1. See “ Chan Profile Setup (Downlink) ” on page 884 for more information.
Frame Index	Specifies which frame of the current allocation for the current user belongs to.
Add	Adds an allocation to the selected user.
Delete	Deletes the selected allocation.

Detection

See “[Detection](#)” on page 884.

Key Path	Meas Setup, Chan Profile Setup, Edit User Mapping
----------	--

RB Auto Detect Mode

See “[RB Auto Detect Mode](#)” on page 885.

Key Path	Meas Setup, Chan Profile Setup, Edit User Mapping
----------	--

Auto Detect Power Levels

See “[Auto Detect Power Levels](#)” on page 886.

Key Path	Meas Setup, Chan Profile Setup, Edit User Mapping
----------	--

Multi-Frame Analysis

Determines whether or not the Multi-Frame Analysis is selected.

When On, the demodulator sets PDSCH allocations for two continuous frames. This parameter needs to be set to On when the signal under analysis is complied with E-UTRA TDD Test Models defined in 3GPP TS36.141 6.1.1 V8.2.0.

NOTE Multi-Frame Analysis is only available for LTETDD downlink and only enabled when detection is manual.

Key Path	Meas Setup, Chan Profile Setup, Edit User Mapping, Detection
----------	---

LTE Modulation Analysis Measurement
Meas Setup (Measurement Setup)

Mode	LTETDD
Remote Command	[:SENSE]:EVM:PROfile:MFANalysis OFF ON 0 1 [:SENSE]:EVM:PROfile:MFANalysis?
Example	EVM:PROF:MFAN ON EVM:PROF:MFAN?
Notes	Changes to this parameter will not be applied until Update Changes command is sent. See “RB Parameter Manager (Downlink)” on page 970 section for more details.
Dependencies	Available only for LTETDD downlink. Enabled when Detection is Manual and Input Channel is 1.
Preset	OFF
State Saved	Saved in instrument state.
Initial S/W Revision	Prior to A.02.00
Modified at S/W Revision	A.03.00

Show Mapping

Selects which frame’s allocations you want to see in RB mapping diagram when Multi Frame Analysis is On.

Key Path	Meas Setup, Chan Profile Setup, Edit User Mapping, Detection
Mode	LTETDD
Remote Command	[:SENSE]:EVM:PROfile:SMAPPING[:SElect] F0 F1 [:SENSE]:EVM:PROfile:SMAPPING[:SElect]?
Example	EVM:PROF:SMAP F0 EVM:PROF:SMAP?
Notes	Changes to this parameter will not be applied until Update Changes command is sent. See “RB Parameter Manager (Downlink)” on page 970 section for more details.
Dependencies	Available only for LTETDD downlink. Enabled when Multi-Frame Analysis is ON.
Preset	F0
State Saved	Saved in instrument state.
Range	F0 F1
Initial S/W Revision	Prior to A.02.00
Modified at S/W Revision	A.03.00

Frame 0

Selects Frame 0 for Show Mapping For to be used by all the Allocations when Multi-Frame Analysis is On.

Key Path	Meas Setup, Chan Profile Setup, Edit User Mapping, Detection, Show Mapping
Mode	LTETDD
Initial S/W Revision	Prior to A.02.00
Modified at S/W Revision	A.03.00

Frame 1

Selects Frame 1 for Show Mapping For to be used by all the Allocations when Multi-Frame Analysis is On.

Key Path	Meas Setup, Chan Profile Setup, Edit User Mapping, Detection, Show Mapping
Mode	LTETDD
Initial S/W Revision	Prior to A.02.00
Modified at S/W Revision	A.03.00

Add Allocation

Adds a new Allocation after the currently selected Allocation and the new entry becomes the selected Allocation. The new Allocation will have the parameters set to the default values.

Key Path	Meas Setup, Chan Profile Setup, Edit User Mapping, Allocation
Mode	LTE, LTETDD
Remote Command	[:SENSe] :EVM:DLINk:PROFile:USER<n>:PDScH:ADD:ALLocation
Example	EVM:DLIN:PROF:USER1:PDSC:ADD:ALL
Notes	Changes to this parameter will not be applied until Update Changes command is sent. See “RB Parameter Manager (Downlink)” on page 970 section for more details.
Dependencies	The range of sub op code <n> values is determined by the number of Users the user has configured. The new Allocation will be added at the end of the currently defined Allocation. Disabled once the number of Allocations reaches to 250 (max).
Initial S/W Revision	Prior to A.02.00
Modified at S/W Revision	A.03.00

Delete Allocation

Deletes the currently selected Allocation.

Key Path	Meas Setup, Chan Profile Setup, Edit User Mapping, Allocation
Mode	LTE, LTETDD
Remote Command	[:SENSe] :EVM:DLINK:PROFile:USER<n>:PDSCh:RBALloc<m>:DELETE
Example	EVM:DLIN:PROF:USER1:PDSC:RBAL1:DEL
Notes	Changes to this parameter will not be applied until Update Changes command is sent. See “RB Parameter Manager (Downlink)” on page 970 section for more details.
Dependencies	Disabled when there is only one Allocation. The range of sub op code <n> values is determined by the number of Users the user has configured. The range of sub op code <m> values is determined by the number of Allocations the user has configured. . Max value for n=50. Max Value for m=250. If the user attempts to delete a Slot that does not exist, an error message will be generated.
Backwards Compatibility SCPI	[:SENSe]:EVM:DLINK:PROFile:USER<n>:PDSCh:ALlocation<m>:DELet e (Max value for n=50 and m=50)
Initial S/W Revision	Prior to A.02.00
Modified at S/W Revision	A.03.00, A.06.00

Include PDSCH

Determines whether or not the PDSCH is included in the results.

Key Path	Meas Setup, Chan Profile Setup, Edit User Mapping
Mode	LTE, LTETDD
Couplings	This parameter provides the Include/Exclude status of the currently selected User, therefore the SCPI commands associated with this parameter will change as the User is changed. When Detection is Auto; when selected User is QPSK, refer to “Include QPSK” on page 895 when selected User is 16QAM, refer to “Include 16QAM” on page 896 when selected User is 64QAM, refer to “Include 64QAM” on page 896 When Detection is Manual, refer to “Include PDSCH” on page 894
Preset	EXCLude
State Saved	Saved in instrument state.

Range	Include Exclude
Modified at S/W Revision	A.03.00

RNTI

Sets downlink user's radio network temporary identifier.

Key Path	Meas Setup, Chan Profile Setup, Edit User Mapping
Mode	LTETDD
Remote Command	[:SENSe]:EVM:DLINk:PROFile:USER<n>:RNTI <integer> [:SENSe]:EVM:DLINk:PROFile:USER<n>:RNTI?
Example	EVM:DLIN:PROF:USER1:RNTI 1 EVM:DLIN:PROF:USER1:RNTI?
Notes	Changes to this parameter will not be applied until Update Changes command is sent. See “RB Parameter Manager (Downlink)” on page 970 section for more details.
Dependencies	The range of sub op code <n> values is determined by the number of Users the user has configured. If the user attempts to remotely set or query a sub op code that is out of range, this will result in an error message. LTE TDD only. Available when Detection is Manual.
Preset	0
State Saved	Saved in instrument state.
Min	0
Max	65535
Initial S/W Revision	A.06.00

Auto Detect RNTI for QPSK

Sets radio network temporary identifier for the QPSK modulation when Detection is Auto.

Key Path	Meas Setup, Chan Profile Setup, Edit User Mapping
Mode	LTETDD
Remote Command	[:SENSe]:EVM:DLINk:PROFile:QPSK:RNTI <integer> [:SENSe]:EVM:DLINk:PROFile:QPSK:RNTI?
Example	EVM:DLIN:PROF:QPSK:RNTI 1 EVM:DLIN:PROF:QPSK:RNTI?
Notes	Changes to this parameter will not be applied until Update Changes command is sent. See section 3.11.7.16.22 RB Parameter Manager (Downlink) for more details.

LTE Modulation Analysis Measurement
Meas Setup (Measurement Setup)

Dependencies	Available when Detection is Auto.
Preset	0
State Saved	Saved in instrument state.
Min	0
Max	65535
Initial S/W Revision	A.10.00

Auto Detect RNTI for 16QAM

Sets radio network temporary identifier for the 16QAM modulation when Detection is Auto.

Key Path	Meas Setup, Chan Profile Setup, Edit User Mapping
Mode	LTETDD
Remote Command	[:SENSE]:EVM:DLINK:PROF:QAM16:RNTI <integer> [:SENSE]:EVM:DLINK:PROF:QAM16:RNTI?
Example	EVM:DLIN:PROF:QAM16:RNTI 1 EVM:DLIN:PROF:QAM16:RNTI?
Notes	Changes to this parameter will not be applied until Update Changes command is sent. See section 3.11.7.16.22 RB Parameter Manager (Downlink) for more details.
Dependencies	Available when Detection is Auto.
Preset	0
State Saved	Saved in instrument state.
Min	0
Max	65535
Initial S/W Revision	A.10.00

Auto Detect RNTI for 64QAM

Sets radio network temporary identifier for the 64QAM modulation when Detection is Auto.

Key Path	Meas Setup, Chan Profile Setup, Edit User Mapping
Mode	LTETDD
Remote Command	[:SENSE]:EVM:DLINK:PROF:QAM64:RNTI <integer> [:SENSE]:EVM:DLINK:PROF:QAM64:RNTI?
Example	EVM:DLIN:PROF:QAM64:RNTI 1 EVM:DLIN:PROF:QAM64:RNTI?

Notes	Changes to this parameter will not be applied until Update Changes command is sent. See section 3.11.7.16.22 RB Parameter Manager (Downlink) for more details.
Dependencies	Available when Detection is Auto.
Preset	0
State Saved	Saved in instrument state.
Min	0
Max	65535
Initial S/W Revision	A.10.00

UE-RS Active

Selects whether or not the UE specific reference signal exists for this downlink user in the input signal.

Key Path	Meas Setup, Chan Profile Setup, Edit User Mapping
Mode	LTETDD
Remote Command	[:SENSE] :EVM:DLINK:PROFile:USER<n>:UERS:ACTive OFF ON 0 1 [:SENSE] :EVM:DLINK:PROFile:USER<n>:UERS:ACTive?
Example	EVM:DLIN:PROF:USER1:UERS:ACT OFF EVM:DLIN:PROF:USER1:UERS:ACT?
Notes	Changes to this parameter will not be applied until Update Changes command is sent. See “RB Parameter Manager (Downlink)” on page 970 section for more details.
Dependencies	Available when Detection is Manual. All softkeys for UE-RS parameters are grayed out when this parameter is set to OFF. LTE TDD only.
Preset	OFF
State Saved	Saved in instrument state.
Range	On Off
Initial S/W Revision	A.06.00

Auto Detect UE-RS Active for QPSK

Selects whether or not the UE specific reference signal exists for the QPSK modulation when Detection is Auto.

Key Path	Meas Setup, Chan Profile Setup, Edit User Mapping
----------	--

LTE Modulation Analysis Measurement
Meas Setup (Measurement Setup)

Mode	LTETDD
Remote Command	[:SENSe] :EVM:DLINK:PROFile:QPSK:UERS:ACTive OFF ON 0 1 [:SENSe] :EVM:DLINK:PROFile:QPSK:UERS:ACTive?
Example	EVM:DLIN:PROF:QPSK:UERS:ACT OFF EVM:DLIN:PROF:QPSK:UERS:ACT?
Notes	Changes to this parameter will not be applied until Update Changes command is sent. See section 3.11.7.16.22 RB Parameter Manager (Downlink) for more details.
Dependencies	Available when Detection is Auto. All softkeys for UE-RS parameters are grayed out when this parameter is set to OFF. LTE TDD only.
Preset	OFF
State Saved	Saved in instrument state.
Range	On Off
Initial S/W Revision	A.10.00

Auto Detect UE-RS Active for 16QAM

Selects whether or not the UE specific reference signal exists for the 16QAM modulation when Detection is Auto.

Key Path	Meas Setup, Chan Profile Setup, Edit User Mapping
Mode	LTETDD
Remote Command	[:SENSe] :EVM:DLINK:PROFile:QAM16:UERS:ACTive OFF ON 0 1 [:SENSe] :EVM:DLINK:PROFile:QAM16:UERS:ACTive?
Example	EVM:DLIN:PROF:QAM16:UERS:ACT OFF EVM:DLIN:PROF:QAM16:UERS:ACT?
Notes	Changes to this parameter will not be applied until Update Changes command is sent. See section 3.11.7.16.22 RB Parameter Manager (Downlink) for more details.
Dependencies	Available when Detection is Auto. All softkeys for UE-RS parameters are grayed out when this parameter is set to OFF. LTE TDD only.
Preset	OFF
State Saved	Saved in instrument state.
Range	On Off
Initial S/W Revision	A.10.00

Auto Detect UE-RS Active for 64QAM

Selects whether or not the UE specific reference signal exists for 64QAM modulation when Detection is Auto.

Key Path	Meas Setup, Chan Profile Setup, Edit User Mapping
Mode	LTETDD
Remote Command	[:SENSE]:EVM:DLINK:PROFile:QAM64:UERS:ACTive OFF ON 0 1 [:SENSE]:EVM:DLINK:PROFile:QAM64:UERS:ACTive?
Example	EVM:DLIN:PROF:QAM64:UERS:ACT OFF EVM:DLIN:PROF:QAM64:UERS:ACT?
Notes	Changes to this parameter will not be applied until Update Changes command is sent. See section 3.11.7.16.22 RB Parameter Manager (Downlink) for more details.
Dependencies	Available when Detection is Auto. All softkeys for UE-RS parameters are grayed out when this parameter is set to OFF. LTE TDD only.
Preset	OFF
State Saved	Saved in instrument state.
Range	On Off
Initial S/W Revision	A.10.00

Include UE-RS

Includes the user defined channel PDSCH's UE specific reference signal in the results.

Key Path	Meas Setup, Chan Profile Setup, Include Users
Mode	LTETDD
Remote Command	[:SENSE]:EVM:DLINK:PROFile:USER<n>:UERS INCLude EXCLude [:SENSE]:EVM:DLINK:PROFile:USER<n>:UERS?
Example	EVM:DLIN:PROF:USER1:UERS EXCL EVM:DLIN:PROF:USER1:UERS?
Notes	Changes to this parameter will not be applied until Update Changes command is sent. See "RB Parameter Manager (Downlink)" on page 970 section for more details.

LTE Modulation Analysis Measurement
Meas Setup (Measurement Setup)

Dependencies	The range of sub op code <n> values is determined by the number of Users the user has configured. If the user attempts to remotely set or query a sub op code that is out of range, this will result in an error message. Available when UE-RS Active is ON and Detection is Manual. LTE TDD only.
Couplings	This parameter is set to Include when Downlink Include All is selected and set to Exclude when Downlink Exclude All is selected.
Preset	EXCLude
State Saved	Saved in instrument state.
Range	Include Exclude
Initial S/W Revision	A.06.00

Auto Detect Include UE-RS for QPSK

Includes UE specific reference signal for the QPSK modulation in the results when Detection is Auto.

Key Path	Meas Setup, Chan Profile Setup, Include Users
Mode	LTETDD
Remote Command	[:SENSe] :EVM:DLINk:PROFile:QPSK:UERS INCLude EXCLude [:SENSe] :EVM:DLINk:PROFile:QPSK:UERS?
Example	EVM:DLIN:PROF:QPSK:UERS EXCL EVM:DLIN:PROF:QPSK:UERS?
Dependencies	Available when UE-RS Active is ON and Detection is Auto.
Couplings	This parameter is set to Include when Downlink Include All is selected and set to Exclude when Downlink Exclude All is selected.
Preset	EXCLude
State Saved	Saved in instrument state.
Range	Include Exclude
Initial S/W Revision	A.10.00

Auto Detect Include UE-RS for 16QAM

Includes UE specific reference signal for the 16QAM modulation in the results when Detection is Auto.

Key Path	Meas Setup, Chan Profile Setup, Include Users
Mode	LTETDD
Remote Command	[:SENSe] :EVM:DLINk:PROFile:QAM16:UERS INCLude EXCLude [:SENSe] :EVM:DLINk:PROFile:QAM16:UERS?

Example	EVM:DLIN:PROF:QAM16:UERS EXCL EVM:DLIN:PROF:QAM16:UERS?
Dependencies	Available when UE-RS Active is ON and Detection is Auto.
Couplings	This parameter is set to Include when Downlink Include All is selected and set to Exclude when Downlink Exclude All is selected.
Preset	EXCLude
State Saved	Saved in instrument state.
Range	Include Exclude
Initial S/W Revision	A.10.00

Auto Detect Include UE-RS for 64QAM

Includes UE specific reference signal for the 64QAM modulation in the results when Detection is Auto.

Key Path	Meas Setup, Chan Profile Setup, Include Users
Mode	LTETDD
Remote Command	[:SENSE] :EVM:DLINK:PROF:ile:QAM64:UERS INCLude EXCLude [:SENSe] :EVM:DLINK:PROF:ile:QAM64:UERS?
Example	EVM:DLIN:PROF:QAM64:UERS EXCL EVM:DLIN:PROF:QAM64:UERS?
Dependencies	Available when UE-RS Active is ON and Detection is Auto.
Couplings	This parameter is set to Include when Downlink Include All is selected and set to Exclude when Downlink Exclude All is selected.
Preset	EXCLude
State Saved	Saved in instrument state.
Range	Include Exclude
Initial S/W Revision	A.10.00

UE-RS Power Boost

Sets the Power Boost value for the specified user. Power Boost value specifies the average power for the UE-specific reference signal.

The average power of the UE-RS power is relative to the 0 dB level determined by the cell-specific RS power level.

Key Path	Meas Setup, Chan Profile Setup, Edit User Mapping
Mode	LTETDD

LTE Modulation Analysis Measurement
Meas Setup (Measurement Setup)

Remote Command	[:SENSe] :EVM:DLINk:PROFile:USER<n>:UERS:PWRBoost <rel_ampl> [:SENSe] :EVM:DLINk:PROFile:USER<n>:UERS:PWRBoost?
Example	EVM:DLIN:PROF:USER1:UERS:PWRB 0 EVM:DLIN:PROF:USER1:UERS:PWRB?
Notes	Changes to this parameter will not be applied until Update Changes command is sent. See “ RB Parameter Manager (Downlink) ” on page 970 section for more details.
Dependencies	The range of sub op code <n> values is determined by the number of Users the user has configured. Max value for n=50. If the user attempts to remotely set or query a sub op code that is out of range, this will result in an error message. available when Detection is Manual. LTE TDD only.
Preset	0 dB
State Saved	Saved in instrument state.
Min	-100 dB
Max	100 dB
Initial S/W Revision	A.06.00

Auto Detect UE-RS Power Boost for QPSK

Determines the Power Boost value for the QPSK modulation when Detection is Auto. Power Boost value specifies the average power for the UE-specific reference signal. The average power of the UE-RS power is relative to the 0 dB level determined by the cell-specific RS power level.

Key Path	Meas Setup, Chan Profile Setup, Edit User Mapping
Mode	LTETDD
Remote Command	[:SENSe] :EVM:DLINk:PROFile:QPSK:UERS:PWRBoost <rel_ampl> [:SENSe] :EVM:DLINk:PROFile:QPSK:UERS:PWRBoost?
Example	EVM:DLIN:PROF:QPSK:UERS:PWRB 0 EVM:DLIN:PROF:QPSK:UERS:PWRB?
Notes	Changes to this parameter will not be applied until Update Changes command is sent. See section 3.11.7.16.22 RB Parameter Manager (Downlink) for more details.
Dependencies	Available when Detection is Auto.
Preset	0 dB

State Saved	Saved in instrument state.
Min	-100 dB
Max	100 dB
Initial S/W Revision	A.10.00

Auto Detect UE-RS Power Boost for 16QAM

Determine the Power Boost value for the 16QAM modulation when Detection is Auto. Power Boost value specifies the average power for the UE-specific reference signal. The average power of the UE-RS power is relative to the 0 dB level determined by the cell-specific RS power level.

Key Path	Meas Setup, Chan Profile Setup, Edit User Mapping
Mode	LTETDD
Remote Command	[:SENSe] :EVM:DLINK:PROFile:QAM16:UERS:PWRBoost <rel_ampl> [:SENSe] :EVM:DLINK:PROFile:QAM16:UERS:PWRBoost?
Example	EVM:DLIN:PROF:QAM16:UERS:PWRB 0 EVM:DLIN:PROF:QAM16:UERS:PWRB?
Notes	Changes to this parameter will not be applied until Update Changes command is sent. See section 3.11.7.16.22 RB Parameter Manager (Downlink) for more details.
Dependencies	Available when Detection is Auto.
Preset	0 dB
State Saved	Saved in instrument state.
Min	-100 dB
Max	100 dB
Initial S/W Revision	A.10.00

Auto Detect UE-RS Power Boost for 64QAM

Determines the Power Boost value for the 64QAM modulation when Detectio is Auto. Power Boost value specifies the average power for the UE-specific reference signal. The average power of the UE-RS power is relative to the 0 dB level determined by the cell-specific RS power level.

Key Path	Meas Setup, Chan Profile Setup, Edit User Mapping
Mode	LTETDD
Remote Command	[:SENSe] :EVM:DLINK:PROFile:QAM64:UERS:PWRBoost <rel_ampl> [:SENSe] :EVM:DLINK:PROFile:QAM64:UERS:PWRBoost?

LTE Modulation Analysis Measurement
Meas Setup (Measurement Setup)

Example	EVM:DLIN:PROF:QAM64:UERS:PWRB 0 EVM:DLIN:PROF:QAM64:UERS:PWRB?
Notes	Changes to this parameter will not be applied until Update Changes command is sent. See section 3.11.7.16.22 RB Parameter Manager (Downlink) for more details.
Dependencies	Available when Detection is Auto.
Preset	0 dB
State Saved	Saved in instrument state.
Min	-100 dB
Max	100 dB
Initial S/W Revision	A.10.00

UE-RS Port

Specifies on which logical antenna port UE-RS is transmitted for the selected PDSCH user allocation when Detectin is Manual.

Key Path	Meas Setup, Chan Profile Setup, Edit User Mapping
Mode	LTETDD
Remote Command	[:SENSE] :EVM:DLINK:PROF:USER<n>:UERS:PORT P5 P7 P8 [:SENSE] :EVM:DLINK:PROF:USER<n>:UERS:PORT?
Example	EVM:DLIN:PROF:USER1:UERS:PORT P5 EVM:DLIN:PROF:USER1:UERS:PORT?
Notes	Changes to this parameter will not be applied until Update Changes command is sent. See section 3.11.7.16.22 RB Parameter Manager (Downlink) for more details.
Dependencies	The range of sub op code <n> values is determined by the number of Users the user has configured. Max value for n= 50 If the user attempts to remotely set or query a sub op code that is out of range, this will result in an error message. Enabled when Detection is Manual, and UE-RS Active is On
Preset	P5
State Saved	Saved in instrument state.
Range	P5 P7 P8
Initial S/W Revision	A.10.00

Auto Detect UE-RS Port for QPSK

Specifies on which logical antenna port UE-RS is transmitted for the QPSK modulation when Detection

is Auto.

Key Path	Meas Setup, Chan Profile Setup, Edit User Mapping
Mode	LTETDD
Remote Command	[:SENSe] :EVM:DLINk:PROFile:QPSK:UERS:PORT P5 P7 P8 [:SENSe] :EVM:DLINk:PROFile:QPSK:UERS:PORT?
Example	EVM:DLIN:PROF:QPSK:UERS:PORT P5 EVM:DLIN:PROF:QPSK:UERS:PORT?
Notes	Changes to this parameter will not be applied until Update Changes command is sent. See section 3.11.7.16.22 RB Parameter Manager (Downlink) for more details.
Dependencies	Enabled when Detection is Auto, and UE-RS Active is On
Preset	P5
State Saved	Saved in instrument state.
Range	P5 P7 P8
Initial S/W Revision	A.10.00

Auto Detect UE-RS Port for 16QAM

Specifies on which logical antenna port UE-RS is transmitted for the 16QAM modulation when Detection is Auto.

Key Path	Meas Setup, Chan Profile Setup, Edit User Mapping
Mode	LTETDD
Remote Command	[:SENSe] :EVM:DLINk:PROFile:QAM16:UERS:PORT P5 P7 P8 [:SENSe] :EVM:DLINk:PROFile:QAM16:UERS:PORT?
Example	EVM:DLIN:PROF:QAM16:UERS:PORT P5 EVM:DLIN:PROF:QAM16:UERS:PORT?
Notes	Changes to this parameter will not be applied until Update Changes command is sent. See section 3.11.7.16.22 RB Parameter Manager (Downlink) for more details.
Dependencies	Enabled when Detection is Auto, and UE-RS Active is On
Preset	P5
State Saved	Saved in instrument state.
Range	P5 P7 P8
Initial S/W Revision	A.10.00

Auto Detect UE-RS Port for 64QAM

Specifies on which logical antenna port UE-RS is transmitted for the 64QAM modulation when Detection is Auto.

Key Path	Meas Setup, Chan Profile Setup, Edit User Mapping
Mode	LTETDD
Remote Command	[:SENSe] :EVM:DLINK:PROF:QAM64:UERS:PORT P5 P7 P8 [:SENSe] :EVM:DLINK:PROF:QAM64:UERS:PORT?
Example	EVM:DLIN:PROF:QAM64:UERS:PORT P5 EVM:DLIN:PROF:QAM64:UERS:PORT?
Notes	Changes to this parameter will not be applied until Update Changes command is sent. See section 3.11.7.16.22 RB Parameter Manager (Downlink) for more details.
Dependencies	Enabled when Detection is Auto, and UE-RS Active is On
Preset	P5
State Saved	Saved in instrument state.
Range	P5 P7 P8
Initial S/W Revision	A.10.00

UE-RS nSCID

Specifies downlink user's scrambling identity value n_{SCID} when Detection is Manual.

Key Path	Meas Setup, Chan Profile Setup, Edit User Mapping
Mode	LTETDD
Remote Command	[:SENSe] :EVM:DLINK:PROF:USER<n>:UERS:SCID <integer> [:SENSe] :EVM:DLINK:PROF:USER<n>:UERS:SCID?
Example	EVM:DLIN:PROF:USER1:UERS:SCID 0 EVM:DLIN:PROF:USER1:UERS:SCID?
Notes	Changes to this parameter will not be applied until Update Changes command is sent. See section 3.11.7.16.22 RB Parameter Manager (Downlink) for more details.
Dependencies	The range of sub op code <n> values is determined by the number of Users the user has configured. If the user attempts to remotely set or query a sub op code that is out of range, this will result in an error message. Available when Detection is Manual and UE-RS Active is On and UE-RS Port is not Port5.
Preset	0

State Saved	Saved in instrument state.
Min	0
Max	1
Initial S/W Revision	A.10.00

Auto Detect UE-RS nSCID for QPSK

Specifies scrambling identity value n_{SCID} for the QPSK modulation when Detection is Auto.

Key Path	Meas Setup, Chan Profile Setup, Edit User Mapping
Mode	LTETDD
Remote Command	[:SENSe]:EVM:DLINk:PROFile:QPSK:UERS:SCID <integer> [:SENSe]:EVM:DLINk:PROFile:QPSK:UERS:SCID?
Example	EVM:DLIN:PROF:QPSK:UERS:SCID 0 EVM:DLIN:PROF:QPSK:UERS:SCID?
Notes	Changes to this parameter will not be applied until Update Changes command is sent. See section 3.11.7.16.22 RB Parameter Manager (Downlink) for more details.
Dependencies	Available when Detection is Auto, UE-RS Active is On, and UE-RS Port is not Port5.
Preset	0
State Saved	Saved in instrument state.
Min	0
Max	1
Initial S/W Revision	A.10.00

Auto Detect UE-RS nSCID for 16QAM

Specifies scrambling identity value n_{SCID} for the 16QAM modulation when Detection is Auto.

Key Path	Meas Setup, Chan Profile Setup, Edit User Mapping
Mode	LTETDD
Remote Command	[:SENSe]:EVM:DLINk:PROFile:QAM16:UERS:SCID <integer> [:SENSe]:EVM:DLINk:PROFile:QAM16:UERS:SCID?
Example	EVM:DLIN:PROF:QAM16:UERS:SCID 0 EVM:DLIN:PROF:QAM16:UERS:SCID?

LTE Modulation Analysis Measurement
Meas Setup (Measurement Setup)

Notes	Changes to this parameter will not be applied until Update Changes command is sent. See section 3.11.7.16.22 RB Parameter Manager (Downlink) for more details.
Dependencies	Available when Detection is Auto, UE-RS Active is On, and UE-RS Port is not Port5.
Preset	0
State Saved	Saved in instrument state.
Min	0
Max	1
Initial S/W Revision	A.10.00

Auto Detect UE-RS nSCID for 64QAM

Specifies scrambling identity value n_{SCID} for the 64QAM modulation when Detection is Auto.

Key Path	Meas Setup, Chan Profile Setup, Edit User Mapping
Mode	LTETDD
Remote Command	[:SENSe] :EVM:DLINk:PROFile:QAM64:UERS:SCID <integer> [:SENSe] :EVM:DLINk:PROFile:QAM64:UERS:SCID?
Example	EVM:DLIN:PROF:QAM64:UERS:SCID 0 EVM:DLIN:PROF:QAM64:UERS:SCID?
Notes	Changes to this parameter will not be applied until Update Changes command is sent. See section 3.11.7.16.22 RB Parameter Manager (Downlink) for more details.
Dependencies	Available when Detection is Auto, UE-RS Active is On, and UE-RS Port is not Port5.
Preset	0
State Saved	Saved in instrument state.
Min	0
Max	1
Initial S/W Revision	A.10.00

Downlink Allocation Parameters

Sets downlink allocation parameters.

Key Path	Meas Setup, Chan Profile Setup, Edit User Mapping
----------	--

Allocation RB Start

Sets the Resource Block start boundary of the selected Allocation.

Key Path	Meas Setup, Chan Profile Setup, Edit User Mapping, RB Start
Mode	LTE, LTETDD
Remote Command	[:SENSe]:EVM:DLINk:PROFile:USER<n>:PDSCh:RBALLoc<m>:RB:START <integer> [:SENSe]:EVM:DLINk:PROFile:USER<n>:PDSCh:RBALLoc<m>RB:START?
Example	EVM:DLIN:PROF:USER1:PDSC:RBAL1:RB:STAR 0 EVM:DLIN:PROF:USER1:PDSC:RBAL1:RB:STAR?
Notes	Changes to this parameter will not be applied until Update Changes command is sent. See “RB Parameter Manager (Downlink)” on page 970 section for more details.
Dependencies	The range of sub op code <n> values is determined by the number of Users the user has configured. The range of sub op code <m> values is determined by the number of Allocations the user has configured. Max value for n=50. Max Value for m=250. If the user attempts to remotely set or query a sub op code that is out of range, this will result in an error message.
Couplings	If the user attempts to set a RB Start value greater than the RB End value, both values are set to the RB Start value or clipped to the min or max value if the entered value is out of range
Preset	0
State Saved	Saved in instrument state.
Min	0
Max	5 - Bandwidth 1.4 MHz 14 - Bandwidth 3 MHz 24 - Bandwidth 5 MHz 49 - Bandwidth 10 MHz 74 - Bandwidth 15 MHz 99 - Bandwidth 20 MHz
Backwards Compatibility SCPI	[:SENSe]:EVM:DLINk:PROFile:USER<n>:PDSCh:ALLOcation<m>:RB:STARt (Max value for n=50 and m=50)
Initial S/W Revision	Prior to A.02.00
Modified at S/W Revision	A.03.00, A.06.00

LTE Modulation Analysis Measurement
Meas Setup (Measurement Setup)

Allocation RB End

Sets the Resource Block stop boundary of the selected Allocation.

Key Path	Meas Setup, Chan Profile Setup, Edit User Mapping, RB End
Mode	LTE, LTETDD
Remote Command	[:SENSe]:EVM:DLINK:PROFile:USER<n>:PDSCh:RBALloc<m>:RB:END <integer> [:SENSe]:EVM:DLINK:PROFile:USER<n>:PDSCh:RBALloc<m>:RB:END?
Example	EVM:DLIN:PROF:USER1:PDSC:RBAL1:RB:END 0 EVM:DLIN:PROF:USER1:PDSC:RBAL1:RB:END?
Notes	Changes to this parameter will not be applied until Update Changes command is sent. See “RB Parameter Manager (Downlink)” on page 970 section for more details.
Dependencies	The range of sub op code <n> values is determined by the number of Users the user has configured. The range of sub op code <m> values is determined by the number of Allocations the user has configured. If the user attempts to remotely set or query a sub op code that is out of range, this will result in an error message.
Couplings	If the user attempts to set a RB End value less than the RB Start value, both values are set to the RB End value or clipped to the min or max value if the entered value is out of range
Preset	0
State Saved	Saved in instrument state.
Min	0
Max	5 - Bandwidth 1.4 MHz 14 - Bandwidth 3 MHz 24 - Bandwidth 5 MHz 49 - Bandwidth 10 MHz 74 - Bandwidth 15 MHz 99 - Bandwidth 20 MHz
Backwards Compatibility SCPI	[:SENSe]:EVM:DLINK:PROFile:USER<n>:PDSCh:ALLocation<m>:RB:END (Max value for n=50 and m=50)
Initial S/W Revision	Prior to A.02.00
Modified at S/W Revision	A.03.00, A.06.00

Allocation Slot Start

Sets the Slot start boundary of the selected Allocation.

Key Path	Meas Setup, Chan Profile Setup, Edit User Mapping, Slot Start
Mode	LTE, LTETDD
Remote Command	[:SENSe]:EVM:DLINK:PROFile:USER<n>:PDSCh:RBALLoc<m>:SLOT:STARt <integer> [:SENSe]:EVM:DLINK:PROFile:USER<n>:PDSCh:RBALLoc<m>:SLOT:STARt?
Example	EVM:DLIN:PROF:USER1:PDSC:RBAL1:SLOT:STAR 0 EVM:DLIN:PROF:USER1:PDSC:RBAL1:SLOT:STAR?
Notes	Changes to this parameter will not be applied until Update Changes command is sent. See “RB Parameter Manager (Downlink)” on page 970 section for more details.
Dependencies	The range of sub op code <n> values is determined by the number of Users the user has configured. The range of sub op code <m> values is determined by the number of Allocations the user has configured. Max value for n=50. Max Value for m=250. If the user attempts to remotely set or query a sub op code that is out of range, this will result in an error message.
Couplings	If the user attempts to set a Slot Start value greater than the Slot End value, both values are set to the Slot Start value or clipped to the min or max value if the entered value is out of range
Preset	0
State Saved	Saved in instrument state.
Min	0
Max	19
Backwards Compatibility SCPI	[:SENSe]:EVM:DLINK:PROFile:USER<n>:PDSCh:ALLocation<m>:SLOT:STARt (Max value for n=50 and m=50)
Initial S/W Revision	Prior to A.02.00
Modified at S/W Revision	A.03.00, A.06.00

Allocation Slot End

Sets the Slot end boundary of the selected Allocation.

Key Path	Meas Setup, Chan Profile Setup, Edit User Mapping, Slot End
Mode	LTE, LTETDD

LTE Modulation Analysis Measurement
Meas Setup (Measurement Setup)

Remote Command	[:SENSe]:EVM:DLINK:PROFile:USER<n>:PDSCh:RBALloc<m>:SLOT:END <integer> [:SENSe]:EVM:DLINK:PROFile:USER<n>:PDSCh:RBALloc<m>:SLOT:END?
Example	EVM:DLIN:PROF:USER1:PDSC:RBAL1:SLOT:END 1 EVM:DLIN:PROF:USER1:PDSC:RBAL1:SLOT:END?
Notes	Changes to this parameter will not be applied until Update Changes command is sent. See “RB Parameter Manager (Downlink)” on page 970 section for more details.
Dependencies	The range of sub op code <n> values is determined by the number of Users the user has configured. The range of sub op code <m> values is determined by the number of Allocations the user has configured. If the user attempts to remotely set or query a sub op code that is out of range, this will result in an error message.
Couplings	If the user attempts to set a Slot End value less than the Slot Start value, both values are set to the Slot End value or clipped to the min or max value if the entered value is out of range
Preset	0
State Saved	Saved in instrument state.
Min	0
Max	19
Backwards Compatibility SCPI	[:SENSe]:EVM:DLINK:PROFile:USER<n>:PDSCh:ALlocation<m>:SLOT:END (Max value for n=50 and m=50)
Initial S/W Revision	Prior to A.02.00
Modified at S/W Revision	A.03.00, A.06.00

Allocation Mod Type for Codeword 0

Selects the Modulation Type for the selected Allocation.

Key Path	Meas Setup, Chan Profile Setup, Edit User Mapping, Mod Type
Mode	LTE, TLTE TDD
Remote Command	[:SENSe]:EVM:DLINK:PROFile:USER<n>:PDSCh:RBALloc<m>:MODulation:TYPE QPSK QAM16 QAM64 [:SENSe]:EVM:DLINK:PROFile:USER<n>:PDSCh:RBALloc<m>:MODulation:TYPE?
Example	EVM:DLIN:PROF:USER1:PDSC:RBAL1:MOD:TYPE QPSK EVM:DLIN:PROF:USER1:PDSC:RBAL1:MOD:TYPE?

Notes	Changes to this parameter will not be applied until Update Changes command is sent. See “RB Parameter Manager (Downlink)” on page 970 section for more details.
Dependencies	The range of sub op code <n> values is determined by the number of Users the user has configured. The range of sub op code <m> values is determined by the number of Allocations the user has configured. Max value for n=50. Max Value for m=250. If the user attempts to remotely set or query a sub op code that is out of range, this will result in an error message. Enabled when Mod Type Couple is OFF and Codeword 0 Enable is ON.
Preset	QPSK
State Saved	Saved in instrument state.
Range	QPSK QAM16 QAM64
Backwards Compatibility SCPI	[[:SENSe]:EVM:DLINk:PROFile:USER<n>:PDSCh:ALLocation<m>:MODulation:TYPE QPSK QAM16 QAM64 (Max value for n=50 and m=50)
Initial S/W Revision	Prior to A.02.00
Modified at S/W Revision	A.03.00, A.06.00

Allocation Mod Type for Codeword 1

Selects the Modulation Type of Codeword 1 for the selected Allocation.

Key Path	Meas Setup, Chan Profile Setup, Edit User Mapping, Mod Type
Mode	LTE, LTETDD
Remote Command	[[:SENSe]:EVM:DLINk:PROFile:USER<n>:PDSCh:RBALloc<m>:CWO Ne:MODulation:TYPE QPSK QAM16 QAM64 [:SENSe]:EVM:DLINk:PROFile:USER<n>:PDSCh:RBALloc<m>:CWO Ne:MODulation:TYPE?
Example	EVM:DLIN:PROF:USER1:PDSC:RBAL1:CWON:MOD:TYPE QPSK EVM:DLIN:PROF:USER1:PDSC:RBAL1:CWON:MOD:TYPE?
Notes	Changes to this parameter will not be applied until Update Changes command is sent. See “RB Parameter Manager (Downlink)” on page 970 section for more details.
Dependencies	Always grayed out since this instrument supports only one RF input.
Preset	QPSK
State Saved	Saved in instrument state.
Range	QPSK QAM16 QAM64

LTE Modulation Analysis Measurement
Meas Setup (Measurement Setup)

Backwards Compatibility SCPI	[:SENSe]:EVM:DLINK:PROFile:USER<n>:PDSCh:ALlocation<m>:CWO Ne:MODulation:TYPE QPSK QAM16 QAM64 (Max value for n=50 and m=50)
Initial S/W Revision	A.03.00, A.06.00

QPSK

Selects QPSK for the Modulation Type of the selected Allocation.

Key Path	Meas Setup, Chan Profile Setup, Edit User Mapping, Mod Type
Mode	LTE, LTETDD
Initial S/W Revision	Prior to A.02.00
Modified at S/W Revision	A.03.00

16QAM

Selects 16QAM for the Modulation Type of the selected Allocation.

Key Path	Meas Setup, Chan Profile Setup, Edit User Mapping, Mod Type
Mode	LTE, LTETDD
Initial S/W Revision	Prior to A.02.00
Modified at S/W Revision	A.03.00

64QAM

Selects 64QAM for the Modulation Type of the selected Allocation.

Key Path	Meas Setup, Chan Profile Setup, Edit User Mapping, Mod Type
Mode	LTE, LTETDD
Initial S/W Revision	Prior to A.02.00
Modified at S/W Revision	A.03.00

Allocation Power Boost for Codeword 0

Sets the Power Boost value for the selected Allocation.

Key Path	Meas Setup, Chan Profile Setup, Edit User Mapping
Mode	LTE, LTETDD
Remote Command	[:SENSe]:EVM:DLINK:PROFile:USER<n>:PDSCh:RBALloc<m>:PWR Boost <rel_amp> [:SENSe]:EVM:DLINK:PROFile:USER<n>:PDSCh:RBALloc<m>:PWR Boost?

Example	EVM:DLIN:PROF:USER1:PDSC:RBAL1:PWRB 0 EVM:DLIN:PROF:USER1:PDSC:RBAL1:PWRB?
Notes	Changes to this parameter will not be applied until Update Changes command is sent. See “RB Parameter Manager (Downlink)” on page 970 section for more details. Enabled when Codeword 0 Enable is ON and Power Boost Couple is OFF.
Dependencies	The range of sub op code <n> values is determined by the number of Users the user has configured. The range of sub op code <m> values is determined by the number of Allocations the user has configured. Max value for n=50. Max Value for m=250. If the user attempts to remotely set or query a sub op code that is out of range, this will result in an error message.
Preset	0 dB
State Saved	Saved in instrument state.
Min	-100 dB
Max	100 dB
Backwards Compatibility SCPI	[[:SENSe]:EVM:DLINk:PROFile:USER<n>:PDSCCh:ALLocation<m>:PWRBoost (Max value for n=50 and m=50)
Initial S/W Revision	Prior to A.02.00
Modified at S/W Revision	A.03.00, A.04.20, A.06.00

Allocation Power Boost for Codeword 1

Sets the Power Boost value of Codeword 1 for the selected Allocation.

Key Path	Meas Setup, Chan Profile Setup, Edit User Mapping
Mode	LTE, LTETDD
Remote Command	[[:SENSe]:EVM:DLINk:PROFile:USER<n>:PDSCCh:RBALloc<m>:CWO Ne:PWRBoost <rel_ampl> [:SENSe]:EVM:DLINk:PROFile:USER<n>:PDSCCh:RBALloc<m>:CWO Ne:PWRBoost?
Example	EVM:DLIN:PROF:USER1:PDSC:RBAL1:CWON:PWRB 0 EVM:DLIN:PROF:USER1:PDSC:RBAL1:CWON:PWRB?
Notes	Changes to this parameter will not be applied until Update Changes command is sent. See “RB Parameter Manager (Downlink)” on page 970 section for more details.
Dependencies	Always grayed out since this instrument supports only one RF input.
Preset	0 dB
State Saved	Saved in instrument state.

LTE Modulation Analysis Measurement
Meas Setup (Measurement Setup)

Min	-100 dB
Max	100 dB
Backwards Compatibility SCPI	[[:SENSe]:EVM:DLINK:PROFile:USER<n>:PDSC:ALlocation<m>:CWO Ne:PWRBoost (Max value for n=50 and m=50)
Initial S/W Revision	A.03.00
Modified at S/W Revision	A.04.20, A.06.00

Allocation Frame Index

Specifies the Frame Index for the selected Allocation.

Key Path	Meas Setup, Chan Profile Setup, Edit User Mapping, Frame Index
Mode	LTETDD
Remote Command	[[:SENSe]:EVM:DLINK:PROFile:USER<n>:PDSC:RBALloc<m>:FIN Dex F0 F1 [:SENSe]:EVM:DLINK:PROFile:USER<n>:PDSC:RBALloc<m>:FIN Dex?
Example	EVM:DLIN:PROF:USER1:PDSC:RBAL1:FIND F0 EVM:DLIN:PROF:USER1:PDSC:RBAL1:FIND?
Notes	Changes to this parameter will not be applied until Update Changes command is sent. See “RB Parameter Manager (Downlink)” on page 970 section for more details.
Dependencies	The range of sub op code <n> values is determined by the number of Users the user has configured. The range of sub op code <m> values is determined by the number of Allocations the user has configured. Max value for n=50. Max Value for m=250. If the user attempts to remotely set or query a sub op code that is out of range, this will result in an error message. Enabled only for the LTE TDD mode. Enabled when Detection is Manual, Multi –Frame Analysis is ON, and Frame Index Couple is OFF.
Preset	F0
State Saved	Saved in instrument state.
Range	F0 F1
Backwards Compatibility SCPI	[[:SENSe]:EVM:DLINK:PROFile:USER<n>:PDSC:ALlocation<m>:FINDe x F0 F1 (Max value for n=50 and m=50)
Initial S/W Revision	Prior to A.02.00
Modified at S/W Revision	A.03.00, A.06.00

PDSCH Common Mod Type

Selects the Modulation Type for all the Allocations when Mod Type Couple is On.

Key Path	Meas Setup, Chan Profile Setup, Edit User Mapping, Mod Type
Mode	LTE, LTETDD
Remote Command	[:SENSE] :EVM:DLINK:PROFile:USER<n>:PDSCh:MODulation:TYPE QPSK QAM16 QAM64 [:SENSE] :EVM:DLINK:PROFile:USER<n>:PDSCh:MODulation:TYPE?
Example	EVM:DLIN:PROF:USER1:PDSC:MOD:TYPE QPSK EVM:DLIN:PROF:USER1:PDSC:MOD:TYPE?
Notes	Changes to this parameter will not be applied until Update Changes command is sent. See “RB Parameter Manager (Downlink)” on page 970 section for more details.
Dependencies	The range of sub op code <n> values is determined by the number of Users the user has configured. Max value for n= 50 If the user attempts to remotely set or query a sub op code that is out of range, this will result in an error message. Enabled when Detection is Manual, Codeword 0 Enable is ON and Mod Type Couple is ON.
Preset	QPSK
State Saved	Saved in instrument state.
Range	QPSK QAM16 QAM64
Initial S/W Revision	Prior to A.02.00
Modified at S/W Revision	A.03.00

Common Mod Type for Codeword 1

Selects the Modulation Type for Codeword 1 for all the Allocations when Mod Type Couple is On.

Key Path	Meas Setup, Chan Profile Setup, Edit User Mapping, Mod Type
Mode	LTE, LTETDD
Remote Command	[:SENSE] :EVM:DLINK:PROFile:USER<n>:PDSCh:CWONE:MODulation:TYPE QPSK QAM16 QAM64 [:SENSE] :EVM:DLINK:PROFile:USER<n>:PDSCh:CWONE:MODulation:TYPE?
Example	EVM:DLIN:PROF:USER1:PDSC:CWON:MOD:TYPE QPSK EVM:DLIN:PROF:USER1:PDSC:CWON:MOD:TYPE?

LTE Modulation Analysis Measurement
Meas Setup (Measurement Setup)

Notes	Changes to this parameter will not be applied until Update Changes command is sent. See “ RB Parameter Manager (Downlink) ” on page 970 section for more details.
Dependencies	Always grayed out since this instrument supports only one RF input.
Preset	QPSK
State Saved	Saved in instrument state.
Range	QPSK QAM16 QAM64
Initial S/W Revision	A.03.00

QPSK

Selects QPSK for the Modulation Type for all the Allocations when Mod Type Couple is On.

Key Path	Meas Setup, Chan Profile Setup, Edit User Mapping, Mod Type
Mode	LTE, LTETDD
Initial S/W Revision	Prior to A.02.00
Modified at S/W Revision	A.03.00

16QAM

Selects 16QAM for the Modulation Type for all the Allocations when Mod Type Couple is On.

Key Path	Meas Setup, Chan Profile Setup, Edit User Mapping, Mod Type
Mode	LTE, LTETDD
Initial S/W Revision	Prior to A.02.00
Modified at S/W Revision	A.03.00

64QAM

Selects 64QAM for the Modulation Type for all the Allocations when Mod Type Couple is On.

Key Path	Meas Setup, Chan Profile Setup, Edit User Mapping, Mod Type
Mode	LTE, LTETDD
Initial S/W Revision	Prior to A.02.00
Modified at S/W Revision	A.03.00

Mod Type Couple

Determines whether or not all the Allocations will use the Common Mod Type value.

Key Path	Meas Setup, Chan Profile Setup, Edit User Mapping, Mod Type
Mode	LTE, LTETDD

Remote Command	[:SENSE]:EVM:DLINK:PROFile:USER<n>:PDSCh:MODulation:TYPE:COUPle OFF ON 0 1 [:SENSE]:EVM:DLINK:PROFile:USER<n>:PDSCh:MODulation:TYPE:COUPle?
Example	EVM:DLIN:PROF:USER1:PDSC:MOD:TYPE:COUP ON EVM:DLIN:PROF:USER1:PDSC:MOD:TYPE:COUP?
Notes	Changes to this parameter will not be applied until Update Changes command is sent. See “RB Parameter Manager (Downlink)” on page 970 section for more details.
Dependencies	The range of sub op code <n> values is determined by the number of Users the user has configured. Max value for n=50. If the user attempts to remotely set or query a sub op code that is out of range, this will result in an error message. Enabled when Detection is Manual and Codeword 0 Enable is ON.
Preset	ON
State Saved	Saved in instrument state.
Initial S/W Revision	Prior to A.02.00
Modified at S/W Revision	A.03.00

Mod Type Couple for Codeword 1

Determines whether or not all the Allocations will use the Common Mod Type value for Codeword 1.

Key Path	Meas Setup, Chan Profile Setup, Edit User Mapping, Mod Type
Mode	LTE, LTETDD
Remote Command	[:SENSE]:EVM:DLINK:PROFile:USER<n>:PDSCh:CWONe:MODulation:TYPE:COUPle OFF ON 0 1 [:SENSE]:EVM:DLINK:PROFile:USER<n>:PDSCh:CWONe:MODulation:TYPE:COUPle?
Example	EVM:DLIN:PROF:USER1:PDSC:CWON:MOD:TYPE:COUP ON EVM:DLIN:PROF:USER1:PDSC:CWON:MOD:TYPE:COUP?
Notes	Changes to this parameter will not be applied until Update Changes command is sent. See “RB Parameter Manager (Downlink)” on page 970 section for more details.
Dependencies	Always grayed out since this instrument supports only one RF input.
Preset	ON
State Saved	Saved in instrument state.
Initial S/W Revision	A.03.00

PDSCH Common Power Boost

See “[Edit User Mapping \(Downlink\)](#)” on page 917.

Key Path	Meas Setup, Chan Profile Setup, Edit User Mapping
----------	--

Common Power Boost for Codeword 0

Sets the Power Boost value for all the Allocations when Power Boost Couple is On.

Power Boost value specifies the average power for the codeword symbols.

The average power of the codeword modulation symbols ($d(q)(i)$) is relative to the 0 dB level determined by the RS power level.

Key Path	Meas Setup, Chan Profile Setup, Edit User Mapping, Power Boost
Mode	LTE, LTETDD
Remote Command	[:SENSe] :EVM:DLINk:PROFile:USER<n>:PDSCh:PWRBoost <rel_ampl> [:SENSe] :EVM:DLINk:PROFile:USER<n>:PDSCh:PWRBoost?
Example	EVM:DLIN:PROF:USER1:PDSC:PWRB 0 EVM:DLIN:PROF:USER1:PDSC:PWRB?
Notes	Changes to this parameter will not be applied until Update Changes command is sent. See “ RB Parameter Manager (Downlink) ” on page 970 section for more details.
Dependencies	The range of sub op code <n> values is determined by the number of Users the user has configured Max value for n=50. If the user attempts to remotely set or query a sub op code that is out of range, this will result in an error message. Enabled when Detection is Manual, Power Boost Couple is ON, and Codeword 0 Enable is ON.
Preset	0 dB
State Saved	Saved in instrument state.
Min	-100 dB
Max	100 dB
Initial S/W Revision	Prior to A.02.00
Modified at S/W Revision	A.03.00, A.04.20

Auto Detect PDSCH QPSK Power Boost

Sets the Power Boost value for PDSCH QPSK Mod Type when Detection is Auto.

Key Path	Meas Setup, Chan Profile Setup, Edit User Mapping, tab
----------	---

Mode	LTE, LTETDD
Remote Command	[:SENSe]:EVM:DLINk:PROFile:AUTO:PDSC:h:QPSK:PWRBoost <rel_ampl> [:SENSe]:EVM:DLINk:PROFile:AUTO:PDSC:h:QPSK:PWRBoost?
Example	EVM:DLIN:PROF:AUTO:PDSC:QPSK:PWRB 0 EVM:DLIN:PROF:AUTO:PDSC:QPSK:PWRB?
Notes	Changes to this parameter will not be applied until Update Changes command is sent. See “RB Parameter Manager (Downlink)” on page 970 section for more details.
Dependencies	Enabled when Detection is Auto and Auto Detect Codeword 0 for QPSK QAM16 QAM64 is ON.
Preset	0
State Saved	Saved in instrument state.
Min	-100
Max	100
Initial S/W Revision	A.03.00, A.04.20

Auto Detect PDSCH 16QAM Power Boost

Sets the Power Boost value for PDSCH 16QAM Mod Type when Detection is Auto.

Key Path	Meas Setup, Chan Profile Setup, Edit User Mapping, tab
Mode	LTE, LTETDD
Remote Command	[:SENSe]:EVM:DLINk:PROFile:AUTO:PDSC:h:QAM16:PWRBoost <rel_ampl> [:SENSe]:EVM:DLINk:PROFile:AUTO:PDSC:h:QAM16:PWRBoost?
Example	EVM:DLIN:PROF:AUTO:PDSC:QAM16:PWRB 0 EVM:DLIN:PROF:AUTO:PDSC:QAM16:PWRB?
Notes	Changes to this parameter will not be applied until Update Changes command is sent. See “RB Parameter Manager (Downlink)” on page 970 section for more details.
Dependencies	Enabled when Detection is Auto and Auto Detect Codeword 0 for QPSK QAM16 QAM64 is ON
Preset	0
State Saved	Saved in instrument state.
Min	-100
Max	100

LTE Modulation Analysis Measurement
Meas Setup (Measurement Setup)

Initial S/W Revision	A.03.00, A.04.20
----------------------	------------------

Auto Detect PDSCH 64QAM Power Boost

Sets the Power Boost value for PDSCH 64QAM Mod Type when Detection is Auto.

Key Path	Meas Setup, Chan Profile Setup, Edit User Mapping, tab
Mode	LTE, LTETDD
Remote Command	[:SENSe] :EVM:DLINk:PROFile:AUTO:PDSC:h:QAM64:PWRBoost <rel_ampl> [:SENSe] :EVM:DLINk:PROFile:AUTO:PDSC:h:QAM64:PWRBoost?
Example	EVM:DLIN:PROF:AUTO:PDSC:QAM64:PWRB 0 EVM:DLIN:PROF:AUTO:PDSC:QAM64:PWRB?
Notes	Changes to this parameter will not be applied until Update Changes command is sent. See “ RB Parameter Manager (Downlink) ” on page 970 section for more details.
Dependencies	Enabled when Detection is Auto and Auto Detect Codeword 0 for QPSK QAM16 QAM64 is ON
Preset	0
State Saved	Saved in instrument state.
Min	-100
Max	100
Initial S/W Revision	A.03.00, A.04.20

Common Power Boost for Codeword 1

Sets the Power Boost value for Codeword 1 for all the Allocations when Power Boost Couple is On.

Key Path	Meas Setup, Chan Profile Setup, Edit User Mapping, Power Boost
Mode	LTE, LTETDD
Remote Command	[:SENSe] :EVM:DLINk:PROFile:USER<n>:PDSC:h:CWONe:PWRBoost <rel_ampl> [:SENSe] :EVM:DLINk:PROFile:USER<n>:PDSC:h:CWONe:PWRBoost? ?
Example	EVM:DLIN:PROF:USER1:PDSC:CWON:PWRB 0 EVM:DLIN:PROF:USER1:PDSC:CWON:PWRB?
Notes	Changes to this parameter will not be applied until Update Changes command is sent. See “ RB Parameter Manager (Downlink) ” on page 970 section for more details.
Dependencies	Always grayed out since this instrument supports only one RF input.

Preset	0 dB
State Saved	Saved in instrument state.
Min	-100 dB
Max	100 dB
Initial S/W Revision	A.03.00, A.04.20

Auto Detect PDSCH QPSK Power Boost for Codeword 1

Sets the Power Boost value for PDSCH QPSK Mod Type for Codeword 1 when Detection is Auto.

Key Path	Meas Setup, Chan Profile Setup, Edit User Mapping, tab
Mode	LTE, LTETDD
Remote Command	[:SENSe]:EVM:DLINk:PROfile:AUTO:PDSC:h:QPSK:CWONe:PWRBo ost <rel_ampl> [:SENSe]:EVM:DLINk:PROfile:AUTO:PDSC:h:QPSK:CWONe:PWRBo ost?
Example	EVM:DLIN:PROF:AUTO:PDSC:QPSK:CWON:PWRB 0 EVM:DLIN:PROF:AUTO:PDSC:QPSK:CWON:PWRB?
Notes	Changes to this parameter will not be applied until Update Changes command is sent. See “RB Parameter Manager (Downlink)” on page 970 section for more details.
Dependencies	Always grayed out since this instrument supports only one RF input.
Preset	0
State Saved	Saved in instrument state.
Min	-100
Max	100
Initial S/W Revision	A.03.00, A.04.20

Auto Detect PDSCH 16QAM Power Boost for Codeword 1

Sets the Power Boost value for PDSCH 16QAM Mod Type for Codeword 1 when Detection is Auto.

Key Path	Meas Setup, Chan Profile Setup, Edit User Mapping, tab
Mode	LTE, LTETDD
Remote Command	[:SENSe]:EVM:DLINk:PROfile:AUTO:PDSC:h:QAM16:CWONe:PWRBo ost <rel_ampl> [:SENSe]:EVM:DLINk:PROfile:AUTO:PDSC:h:QAM16:CWONe:PWRBo ost?

LTE Modulation Analysis Measurement
Meas Setup (Measurement Setup)

Example	EVM:DLIN:PROF:AUTO:PDSC:QAM16:CWON:PWRB 0 EVM:DLIN:PROF:AUTO:PDSC:QAM16:CWON:PWRB?
Notes	Changes to this parameter will not be applied until Update Changes command is sent. See “RB Parameter Manager (Downlink)” on page 970 section for more details.
Dependencies	Always grayed out since this instrument supports only one RF input.
Preset	0
State Saved	Saved in instrument state.
Min	-100
Max	100
Initial S/W Revision	A.03.00, A.04.20

Auto Detect PDSCH 64QAM Power Boost for Codeword 1

Sets the Power Boost value for PDSCH 64QAM Mod Type for Codeword 1 when Detection is Auto.

Key Path	Meas Setup, Chan Profile Setup, Edit User Mapping, tab
Mode	LTE, LTETDD
Remote Command	[:SENSe] :EVM:DLINk:PROFile:AUTO:PDSC:QAM64:CWONe:PWRBo ost <rel_ampl> [:SENSe] :EVM:DLINk:PROFile:AUTO:PDSC:QAM64:CWONe:PWRBo ost?
Example	EVM:DLIN:PROF:AUTO:PDSC:QAM64:CWON:PWRB 0 EVM:DLIN:PROF:AUTO:PDSC:QAM64:CWON:PWRB?
Notes	Changes to this parameter will not be applied until Update Changes command is sent. See “RB Parameter Manager (Downlink)” on page 970 section for more details.
Dependencies	Always grayed out since this instrument supports only one RF input.
Preset	0
State Saved	Saved in instrument state.
Min	-100
Max	100
Initial S/W Revision	A.03.00, A.04.20

Decoded User Power Boost for Codeword 0

Sets the Power Boost value for the specified user.

Key Path	Meas Setup, Chan Profile Setup, Edit User Mapping, Power Boost
----------	---

Mode	LTE, LTETDD
Remote Command	[:SENSe]:EVM:DLINk:PROFile:USER<n>:DECoded:PDSCh:CWZero:PWRBoost <rel_ampl> [:SENSe]:EVM:DLINk:PROFile:USER<n>:DECoded:PDSCh:CWZero:PWRBoost?
Example	EVM:DLIN:PROF:USER1:DEC:PDSC:CWZ:PWRB 0 EVM:DLIN:PROF:USER1:DEC:PDSC:CWZ:PWRB?
Notes	Changes to this parameter will not be applied until Update Changes command is sent. See “RB Parameter Manager (Downlink)” on page 970 section for more details.
Dependencies	The range of sub op code <n> values is determined by the number of Users the user has configured Max value for n=50. If the user attempts to remotely set or query a sub op code that is out of range, this will result in an error message. Available when all the following conditions are met. Direction is Downlink. Detection is Auto. RB Auto Detect Mode is Decoded PDCCH. Codeword 0 Enable for Decoded User is ON.
Preset	0 dB
State Saved	Saved in instrument state.
Min	-100 dB
Max	100 dB
Initial S/W Revision	A.06.00

Decoded User Power Boost for Codeword 1

Sets the Power Boost value for the specified user.

Key Path	Meas Setup, Chan Profile Setup, Edit User Mapping, Power Boost
Mode	LTE, LTETDD
Remote Command	[:SENSe]:EVM:DLINk:PROFile:USER<n>:DECoded:PDSCh:CWONE:PWRBoost <rel_ampl> [:SENSe]:EVM:DLINk:PROFile:USER<n>:DECoded:PDSCh:CWONE:PWRBoost?
Example	EVM:DLIN:PROF:USER1:DEC:PDSC:CWON:PWRB 0
Notes	Changes to this parameter will not be applied until Update Changes command is sent. See “RB Parameter Manager (Downlink)” on page 970 section for more details.

LTE Modulation Analysis Measurement
Meas Setup (Measurement Setup)

Dependencies	<p>The range of sub op code <n> values is determined by the number of Users the user has configured. Max value for n=50.</p> <p>If the user attempts to remotely set or query a sub op code that is out of range, this will result in an error message.</p> <p>Available when all the following conditions are met.</p> <p>Direction is Downlink.</p> <p>Detection is Auto.</p> <p>RB Auto Detect Mode is Decoded PDCCH.</p> <p>Codeword 1 Enable for Decoded User is ON.</p>
Preset	0 dB
State Saved	Saved in instrument state.
Min	-100 dB
Max	100 dB
Initial S/W Revision	A.06.00

Power Boost Couple

Determines whether or not all the Allocations will use the Common Power Boost value.

Key Path	Meas Setup, Chan Profile Setup, Edit User Mapping, Power Boost
Mode	LTE, LTETDD
Remote Command	<pre>[:SENSe] :EVM:DLINK:PROFile:USER<n>:PDSch:PWRBoost:COUPl e OFF ON 0 1</pre> <pre>[:SENSe] :EVM:DLINK:PROFile:USER<n>:PDSch:PWRBoost:COUPl e?</pre>
Example	<pre>EVM:DLIN:PROF:USER1:PDSC:PWRB:COUP 0</pre> <pre>EVM:DLIN:PROF:USER1:PDSC:PWRB:COUP?</pre>
Notes	Changes to this parameter will not be applied until Update Changes command is sent. See “RB Parameter Manager (Downlink)” on page 970 section for more details.
Dependencies	<p>The range of sub op code <n> values is determined by the number of Users the user has configured. Max value for n=50.</p> <p>If the user attempts to remotely set or query a sub op code that is out of range, this will result in an error message.</p> <p>Enabled when Codeword 0 Enable is ON and Detection is Manual.</p>
Preset	ON
State Saved	Saved in instrument state.
Initial S/W Revision	Prior to A.02.00

Modified at S/W Revision	A.03.00
--------------------------	---------

Power Boost Couple for Codeword 1

Determines whether or not all the Allocations will use the Common Power Boost value for Codeword 1.

Key Path	Meas Setup, Chan Profile Setup, Edit User Mapping, Power Boost
Mode	LTE, LTETDD
Remote Command	[:SENSe] :EVM:DLINk:PROFile:USER<n>:PDSCh:CWONe:PWRBoost :COUPle OFF ON 0 1 [:SENSe] :EVM:DLINk:PROFile:USER<n>:PDSCh:CWONe:PWRBoost :COUPle?
Example	EVM:DLIN:PROF:USER1:PDSC:CWON:PWRB:COUP 0 EVM:DLIN:PROF:USER1:PDSC:CWON:PWRB:COUP?
Notes	Changes to this parameter will not be applied until Update Changes command is sent. See “RB Parameter Manager (Downlink)” on page 970 section for more details.
Dependencies	Always grayed out since this instrument supports only one RF input.
Preset	ON
State Saved	Saved in instrument state.
Initial S/W Revision	A.03.00

Codeword

Enables Codeword 0 and Codeword 1.

Key Path	Meas Setup, Chan Profile Setup, Edit User Mapping
----------	--

Codeword 0 Enable

Enables parameters for Codeword 0 and includes Codeword 0 in the analysis when Detection is Manual.

Key Path	Meas Setup, Chan Profile Setup, Edit User Mapping
Mode	LTE, LTETDD
Remote Command	[:SENSe] :EVM:DLINk:PROFile:USER1 50:PDSCh:CWZero:ENABle ON OFF 0 1 [:SENSe] :EVM:DLINk:PROFile:USER1 50:PDSCh:CWZero:ENABle ?
Example	EVM:DLIN:PROF:USER1:PDSC:CWZ:ENAB ON EVM:DLIN:PROF:USER1:PDSC:CWZ:ENAB?

LTE Modulation Analysis Measurement
Meas Setup (Measurement Setup)

Notes	Changes to this parameter will not be applied until Update Changes command is sent. See “ RB Parameter Manager (Downlink) ” on page 970 section for more details.
Dependencies	Enabled when Detection is Manual.
Preset	ON
State Saved	Saved in instrument state.
Initial S/W Revision	A.03.00

Auto Detect Codeword 0 Enable for QPSK

Enables parameters for Codeword 0 for QPSK modulation when Detection is Auto.

Key Path	Meas Setup, Chan Profile Setup, Edit User Mapping
Mode	LTE, LTETDD
Remote Command	[:SENSE]:EVM:DLINK:PROF:FILE:AUTO:PDSC:QPSK:CWZERO:ENABLE ON OFF 0 1 [:SENSE]:EVM:DLINK:PROF:FILE:AUTO:PDSC:QPSK:CWZERO:ENABLE?
Example	EVM:DLIN:PROF:AUTO:PDSC:QPSK:CWZ:ENAB ON EVM:DLIN:PROF:AUTO:PDSC:QPSK:CWZ:ENAB?
Notes	Changes to this parameter will not be applied until Update Changes command is sent. See “ RB Parameter Manager (Downlink) ” on page 970 section for more details.
Dependencies	Enabled when Detection is Auto.
Preset	ON
State Saved	Saved in instrument state.
Initial S/W Revision	A.03.00

Auto Detect Codeword 0 Enable for 16QAM

Enables parameters for Codeword 0 for 16QAM modulation when Detection is Auto.

Key Path	Meas Setup, Chan Profile Setup, Edit User Mapping
Mode	LTE, LTETDD
Remote Command	[:SENSE]:EVM:DLINK:PROF:FILE:AUTO:PDSC:QAM16:CWZERO:ENABLE ON OFF 0 1 [:SENSE]:EVM:DLINK:PROF:FILE:AUTO:PDSC:QAM16:CWZERO:ENABLE?
Example	EVM:DLIN:PROF:AUTO:PDSC:QAM16:CWZ:ENAB ON EVM:DLIN:PROF:AUTO:PDSC:QAM16:CWZ:ENAB?

Notes	Changes to this parameter will not be applied until Update Changes command is sent. See “RB Parameter Manager (Downlink)” on page 970 section for more details.
Dependencies	Enabled when Detection is Auto.
Preset	ON
State Saved	Saved in instrument state.
Initial S/W Revision	A.03.00

Auto Detect Codeword 0 Enable for 64QAM

Enables parameters for Codeword 0 for 64QAM modulation when Detection is Auto.

Key Path	Meas Setup, Chan Profile Setup, Edit User Mapping
Mode	LTE, LTETDD
Remote Command	[:SENSe]:EVM:DLINK:PROfile:AUTO:PDSC:QAM64:CWZero:ENAB le ON OFF 0 1 [:SENSe]:EVM:DLINK:PROfile:AUTO:PDSC:QAM64:CWZero:ENAB le?
Example	EVM:DLIN:PROF:AUTO:PDSC:QAM64:CWZ:ENAB ON EVM:DLIN:PROF:AUTO:PDSC:QAM64:CWZ:ENAB?
Notes	Changes to this parameter will not be applied until Update Changes command is sent. See “RB Parameter Manager (Downlink)” on page 970 section for more details.
Dependencies	Enabled when Detection is Auto.
Preset	ON
State Saved	Saved in instrument state.
Initial S/W Revision	A.03.00

Codeword 1 Enable

Enables parameters for Codeword 1 and includes Codeword 1 in the analysis when Detection is Manual.

Key Path	Meas Setup, Chan Profile Setup, Edit User Mapping
Mode	LTE, LTETDD
Remote Command	[:SENSe]:EVM:DLINK:PROfile:USER1 50:PDSC:CWONe:ENAB le ON OFF 0 1 [:SENSe]:EVM:DLINK:PROfile:USER1 50:PDSC:CWONe:ENABe?
Example	EVM:DLIN:PROF:USER1:PDSC:CWON ON

LTE Modulation Analysis Measurement
Meas Setup (Measurement Setup)

Notes	Changes to this parameter will not be applied until Update Changes command is sent. See “ RB Parameter Manager (Downlink) ” on page 970 section for more details.
Dependencies	Always grayed out since this instrument supports only one RF input.
Preset	ON
State Saved	Saved in instrument state.
Initial S/W Revision	A.03.00

Auto Detect Codeword 1 Enable for QPSK

Enables parameters for Codeword 1 for QPSK modulation when Detection is Auto.

Key Path	Meas Setup, Chan Profile Setup, Edit User Mapping
Mode	LTE, LTETDD
Remote Command	[:SENSE]:EVM:DLINK:PROFILE:AUTO:PDSC:QPSK:CWON:ENABLE ON OFF 0 1 [:SENSE]:EVM:DLINK:PROFILE:AUTO:PDSC:QPSK:CWON:ENABLE ?
Example	EVM:DLIN:PROF:AUTO:PDSC:QPSK:CWON:ENAB ON EVM:DLIN:PROF:AUTO:PDSC:QPSK:CWON:ENAB?
Notes	Changes to this parameter will not be applied until Update Changes command is sent. See “ RB Parameter Manager (Downlink) ” on page 970 section for more details.
Dependencies	Always grayed out since this instrument supports only one RF input.
Preset	ON
State Saved	Saved in instrument state.
Initial S/W Revision	A.03.00

Auto Detect Codeword 1 Enable for 16QAM

Enables parameters for Codeword 1 for 16QAM modulation when Detection is Auto.

Key Path	Meas Setup, Chan Profile Setup, Edit User Mapping
Mode	LTE, LTETDD
Remote Command	[:SENSE]:EVM:DLINK:PROFILE:AUTO:PDSC:QAM16:CWON:ENAB le ON OFF 0 1 [:SENSE]:EVM:DLINK:PROFILE:AUTO:PDSC:QAM16:CWON:ENAB le?
Example	EVM:DLIN:PROF:AUTO:PDSC:QAM16:CWON:ENAB ON EVM:DLIN:PROF:AUTO:PDSC:QAM16:CWON:ENAB?

Notes	Changes to this parameter will not be applied until Update Changes command is sent. See “RB Parameter Manager (Downlink)” on page 970 section for more details.
Dependencies	Always grayed out since this instrument supports only one RF input.
Preset	ON
State Saved	Saved in instrument state.
Initial S/W Revision	A.03.00

Auto Detect Codeword 1 Enable for 64QAM

Enables parameters for Codeword 1 for 64QAM modulation when Detection is Auto.

Key Path	Meas Setup, Chan Profile Setup, Edit User Mapping
Mode	LTE, LTETDD
Remote Command	[:SENSE] :EVM:DLINK:PROFILE:AUTO:PDSC:QAM64:CWON:ENABLE ON OFF 0 1 [:SENSE] :EVM:DLINK:PROFILE:AUTO:PDSC:QAM64:CWON:ENABLE?
Example	EVM:DLIN:PROF:AUTO:PDSC:QAM64:CWON:ENAB ON EVM:DLIN:PROF:AUTO:PDSC:QAM64:CWON:ENAB?
Notes	Changes to this parameter will not be applied until Update Changes command is sent. See “RB Parameter Manager (Downlink)” on page 970 section for more details.
Dependencies	Always grayed out since this instrument supports only one RF input.
Preset	ON
State Saved	Saved in instrument state.
Initial S/W Revision	A.03.00

Codeword 0 Enable for Decoded User

Enables parameters for Codeword 0 and includes Codeword 0 in the analysis.

Key Path	Meas Setup, Chan Profile Setup, Edit User Mapping
Mode	LTE, LTETDD
Remote Command	[:SENSE] :EVM:DLINK:PROFILE:USER<n>:DECODED:PDSC:CWZERO:ENABLE ON OFF 0 1 [:SENSE] :EVM:DLINK:PROFILE:USER<n>:DECODED:PDSC:CWZERO:ENABLE?
Example	EVM:DLIN:PROF:USER1:DEC:PDSC:CWZ:ENAB ON EVM:DLIN:PROF:USER1:DEC:PDSC:CWZ:ENAB?

LTE Modulation Analysis Measurement
Meas Setup (Measurement Setup)

Notes	Changes to this parameter will not be applied until Update Changes command is sent. See “ RB Parameter Manager (Downlink) ” on page 970 section for more details.
Dependencies	Available when Detection is Auto, RB Auto Detect Mode is Decoded PDCCH and Auto Detect Power Levels is Off.
Preset	ON
State Saved	Saved in instrument state.
Range	On Off
Initial S/W Revision	A.06.00

Codeword 1 Enable for Decoded User

Enables parameters for Codeword 1 and includes Codeword 1 in the analysis.

Key Path	Meas Setup, Chan Profile Setup, Edit User Mapping
Mode	LTE, LTETDD
Remote Command	[:SENSe]:EVM:DLINK:PROF:USER<n>:DECoded:PDSC:CWONe:ENABle ON OFF 0 1 [:SENSe]:EVM:DLINK:PROF:USER<n>:DECoded:PDSC:CWONe:ENABle?
Example	EVM:DLIN:PROF:USER1:DEC:PDSC:CWON:ENAB ON EVM:DLIN:PROF:USER1:DEC:PDSC:CWON:ENAB?
Notes	Changes to this parameter will not be applied until Update Changes command is sent. See “ RB Parameter Manager (Downlink) ” on page 970 section for more details.
Dependencies	Available when Detection is Auto, RB Auto Detect Mode is Decoded PDCCH, and Auto-detect Power Levels is Off.
Preset	ON
State Saved	Saved in instrument state.
Range	On Off
Initial S/W Revision	A.06.00

Common Frame Index

Select the Frame Index for all the Allocations when Frame Index Couple is On.

Key Path	Meas Setup, Chan Profile Setup, Edit User Mapping, Frame Index
Mode	LTETDD
Remote Command	[:SENSe]:EVM:DLINK:PROF:USER<n>:PDSC:FINDex F0 F1 [:SENSe]:EVM:DLINK:PROF:USER<n>:PDSC:FINDex?

Example	EVM:DLIN:PROF:USER1:PDSC:FIND F0 EVM:DLIN:PROF:USER1:PDSC:FIND?
Notes	Changes to this parameter will not be applied until Update Changes command is sent. See “RB Parameter Manager (Downlink)” on page 970 section for more details.
Dependencies	The range of sub op code <n> values is determined by the number of Users the user has configured. Max value for n= 50 If the user attempts to remotely set or query a sub op code that is out of range, this will result in an error message. Enabled when all the following conditions are met. Detection is Manual. Multi-Frame Analysis is ON. Frame Index Couple is ON.
Preset	F0
State Saved	Saved in instrument state.
Range	F0 F1
Initial S/W Revision	Prior to A.02.00
Modified at S/W Revision	A.03.00

Frame 0

Selects Frame 0 for the Frame Index for all the Allocations when Frame Index Couple is On.

Key Path	Meas Setup, Chan Profile Setup, Edit User Mapping, Frame Index
Mode	LTETDD
Initial S/W Revision	Prior to A.02.00
Modified at S/W Revision	A.03.00

Frame 1

Selects Frame 1 for the Frame Index for all the Allocations when Frame Index Couple is On.

Key Path	Meas Setup, Chan Profile Setup, Edit User Mapping, Frame Index
Mode	LTETDD
Initial S/W Revision	Prior to A.02.00
Modified at S/W Revision	A.03.00

LTE Modulation Analysis Measurement
Meas Setup (Measurement Setup)

Frame Index Couple

Sets all the Allocations to use the Common Frame Index value.

Key Path	Meas Setup, Chan Profile Setup, Edit User Mapping, Frame Index
Mode	LTETDD
Remote Command	[:SENSe] :EVM:DLINK:PROFfile:USER<n>:PDSCh:FINDex:COUPle OFF ON 0 1 [:SENSe] :EVM:DLINK:PROFfile:USER<n>:PDSCh:FINDex:COUPle?
Example	EVM:DLIN:PROF:USER1:PDSC:FIND:COUP ON EVM:DLIN:PROF:USER1:PDSC:FIND:COUP?
Notes	Changes to this parameter will not be applied until Update Changes command is sent. See “RB Parameter Manager (Downlink)” on page 970 section for more details.
Dependencies	The range of sub op code <n> values is determined by the number of Users the user has configured. Max value for n=50. If the user attempts to remotely set or query a sub op code that is out of range, this will result in an error message. Enabled when the Mode is LTE TDD, Detection is Manual, and Multi-Frame Analysis is ON.
Preset	ON
State Saved	Saved in instrument state.
Initial S/W Revision	Prior to A.02.00
Modified at S/W Revision	A.03.00

Add User

Adds a new User and the new entry becomes the selected User. The new User will contain as default one Allocation that has the associated parameters set to the default values.

Key Path	Meas Setup, Chan Profile Setup, Edit User Mapping, PDSCH
Mode	LTE, LTETDD
Remote Command	[:SENSe] :EVM:DLINK:PROFfile:ADD:USER
Example	EVM:DLIN:PROF:ADD:USER
Notes	Changes to this parameter will not be applied until Update Changes command is sent. See “RB Parameter Manager (Downlink)” on page 970 section for more details.
Dependencies	The new User will be added at the end of the currently defined Users. Disabled once the number of Users reaches to 50, the max number.
Initial S/W Revision	Prior to A.02.00

Modified at S/W Revision	A.03.00
--------------------------	---------

Delete User

Deletes the current selected User.

Key Path	Meas Setup, Chan Profile Setup, Edit User Mapping, PDSCH
Mode	LTE, LTETDD
Remote Command	[:SENSE] :EVM:DLINk:PROFile:USER<n>:DELeTe
Example	EVM:DLIN:PROF:USER1:DEL
Notes	Changes to this parameter will not be applied until Update Changes command is sent. See “RB Parameter Manager (Downlink)” on page 970 section for more details.
Dependencies	Disabled when there is only one User. The range of sub op code <n> values is determined by the number of Users the user has configured. If the user attempts to remotely delete a sub op code that is out of range, this will result in an error message.
Initial S/W Revision	Prior to A.02.00
Modified at S/W Revision	A.03.00

Precoding Parameters

Sets up precoding parameters for PDSCH.

Key Path	Meas Setup, Chan Profile Setup, Edit User Mapping
----------	--

Precoding

Selects the Precoding method for each User when Detection is Manual.

This parameter specifies the type of MIMO precoding performed on the current user's data. The possible choices are Off, Transmit Diversity (TxDiv) and Spatial Multiplexing (SpMux).

- OFF - Off
- TXDiversity - Tx Diversity
- SMULTiplex - Spatial Multiplexing

When SpMux is selected, the parameters Number of Layers, Number of Codewords, CDD, and Codebook Index must also be specified.

NOTE RB Auto Detection can detect allocations of either SpMux or TxDiv, but not both. When Detection is Auto, this parameter determines which type of Precoding the demodulator looks for.

LTE Modulation Analysis Measurement
Meas Setup (Measurement Setup)

Key Path	Meas Setup, Chan Profile Setup, Edit User Mapping
Mode	LTE, LTETDD
Remote Command	[:SENSe]:EVM:DLINk:PROFile:USER1 50:PDSCh:PRECoding OFF TXDiversity SMULtiplex [:SENSe]:EVM:DLINk:PROFile:USER1 50:PDSCh:PRECoding?
Example	EVM:DLIN:PROF:USER1:PDSC:PREC TXD EVM:DLIN:PROF:USER1:PDSC:PREC?
Notes	Changes to this parameter will not be applied until Update Changes command is sent. See “ RB Parameter Manager (Downlink) ” on page 970 section for more details.
Dependencies	Enabled when Detection is Manual and Number of Tx Antenna is set to more than 1.
Preset	TXDiversity
State Saved	Saved in instrument state.
Range	Off Tx Diversity Spatial Multiplexing
Initial S/W Revision	A.03.00
Modified at S/W Revision	A.10.00

Auto Detect Precoding

Selects the Precoding method when Detection is Auto.

Key Path	Meas Setup, Chan Profile Setup, Edit User Mapping
Mode	LTE, LTETDD
Remote Command	[:SENSe]:EVM:DLINk:PROFile:AUTO:PDSCh:PRECoding OFF TXDiversity SMULtiplex [:SENSe]:EVM:DLINk:PROFile:AUTO:PDSCh:PRECoding?
Example	EVM:DLIN:PROF:AUTO:PDSC:PREC TXD EVM:DLIN:PROF:AUTO:PDSC:PREC?
Notes	Changes to this parameter will not be applied until Update Changes command is sent. See “ RB Parameter Manager (Downlink) ” on page 970 section for more details.
Dependencies	Enabled when Detection is Auto, Detection Mode is Power Based, and Number of Tx Antenna is set to more than 1.
Preset	TXDiversity
State Saved	Saved in instrument state.

Range	Off Tx Diversity Spatial Multiplexing
Initial S/W Revision	A.03.00
Modified at S/W Revision	A.10.00

Number of Layers

Sets the number of layers when Detection is Manual.

Key Path	Meas Setup, Channel Profile Setup, Edit User Mapping
Mode	LTE, LTETDD
Remote Command	[:SENSE]:EVM:DLINK:PROfile:USER1 50:PDSC:NLAYers <integer> [:SENSe]:EVM:DLINK:PROfile:USER1 50:PDSC:NLAYers?
Example	EVM:DLIN:PROF:USER1:PDSC:NLAY 1 EVM:DLIN:PROF:USER1:PDSC:NLAY?
Notes	Changes to this parameter will not be applied until Update Changes command is sent. See “RB Parameter Manager (Downlink)” on page 970 section for more details. Always 1 since this instrument supports only one RF input.
Dependencies	Enabled only when Detection is Manual, Number of Tx Antenna is more than 1 and Precoding is set to Spatial Multiplexing.
Couplings	Coupled with Number of Tx Antenna, Precoding.
Preset	1
State Saved	Saved in instrument state.
Min	1
Max	4
Initial S/W Revision	A.03.00

Auto Detect Number of Layers

Sets the number of layers when Detection is Auto.

Key Path	Meas Setup, Channel Profile Setup, Edit User Mapping
Mode	LTE, LTETDD
Remote Command	[:SENSE]:EVM:DLINK:PROfile:AUTO:PDSC:NLAYers <integer> [:SENSe]:EVM:DLINK:PROfile:AUTO:PDSC:NLAYers?
Example	EVM:DLIN:PROF:AUTO:PDSC:NLAY 1 EVM:DLIN:PROF:AUTO:PDSC:NLAY?

LTE Modulation Analysis Measurement
Meas Setup (Measurement Setup)

Notes	Changes to this parameter will not be applied until Update Changes command is sent. See “ RB Parameter Manager (Downlink) ” on page 970 section for more details. Always 1 since this instrument supports only one RF input.
Dependencies	Enabled only when Detection is Auto, Number of Tx Antenna is more than 1 and Auto Detect Precoding is set to Spatial Multiplexing.
Couplings	Coupled with Number of Tx Antenna, Precoding
Preset	1
State Saved	Saved in instrument state.
Min	1
Max	4
Initial S/W Revision	A.03.00

Number of Codewords

Sets the number of codewords when Detection is Manual.

Key Path	Meas Setup, Channel Profile Setup, Edit User Mapping
Mode	LTE, LTETDD
Remote Command	[:SENSe] :EVM:DLINk:PROFile:USER1 50 :PDSCh:NCODewords <integer> [:SENSe] :EVM:DLINk:PROFile:USER1 50 :PDSCh:NCODewords?
Example	EVM:DLIN:PROF:USER1:PDSC:NCOD 1 EVM:DLIN:PROF:USER1:PDSC:NCOD?
Notes	Changes to this parameter will not be applied until Update Changes command is sent. See “ RB Parameter Manager (Downlink) ” on page 970 section for more details.
Dependencies	Always grayed out since this instrument supports only one RF input.
Couplings	Coupled with Precoding.
Preset	1
State Saved	Saved in instrument state.
Min	1
Max	2
Initial S/W Revision	A.03.00

Auto Detect Number of Codewords

Sets the number of codewords when Detection is Auto.

Key Path	Meas Setup, Channel Profile Setup, Edit User Mapping
Mode	LTE, LTETDD
Remote Command	[:SENSE] :EVM:DLINk:PROFile:AUTO:PDSC:h:NCODewords <integer> [:SENSE] :EVM:DLINk:PROFile:AUTO:PDSC:h:NCODewords?
Example	EVM:DLIN:PROF:AUTO:PDSC:NCOD 1 EVM:DLIN:PROF:AUTO:PDSC:NCOD?
Notes	Changes to this parameter will not be applied until Update Changes command is sent. See “RB Parameter Manager (Downlink)” on page 970 section for more details.
Dependencies	Always grayed out since this instrument supports only one RF input.
Couplings	Coupled with Precoding
Preset	1
State Saved	Saved in instrument state.
Min	1
Max	2
Initial S/W Revision	A.03.00

Precoding CDD

Sets whether precoding will be done without cyclic delay diversity (CDD) or with large delay CDD for spatial multiplexing when Detection is Manual.

Key Path	Meas Setup, Channel Profile Setup, Edit User Mapping
Mode	LTE, LTETDD
Remote Command	[:SENSE] :EVM:DLINk:PROFile:USER1 50:PDSC:h:CDD WOCDD LDCDD [:SENSE] :EVM:DLINk:PROFile:USER1 50:PDSC:h:CDD?
Example	EVM:DLIN:PROF:USER1:PDSC:CDD WOCDD EVM:DLIN:PROF:USER1:PDSC:CDD?
Notes	Changes to this parameter will not be applied until Update Changes command is sent. See “RB Parameter Manager (Downlink)” on page 970 section for more details.
Dependencies	Always grayed out since this instrument supports only one RF input.
Preset	WOCDD

LTE Modulation Analysis Measurement
Meas Setup (Measurement Setup)

State Saved	Saved in instrument state.
Range	Without CDD Large Delay CDD
Initial S/W Revision	A.03.00

Auto Detect Precoding CDD

Determines whether precoding will be done without cyclic delay diversity (CDD) or with large delay CDD for spatial multiplexing when Detection is Auto.

Key Path	Meas Setup, Channel Profile Setup, Edit User Mapping
Mode	LTE, LTETDD
Remote Command	[:SENSE] :EVM:DLINK:PROFile:AUTO:PDsch:CDD WOCDD LDCDD [:SENSE] :EVM:DLINK:PROFile:AUTO:PDsch:CDD?
Example	EVM:DLIN:PROFile:AUTO:PDSC:CDD WOCDD EVM:DLIN:PROFile:AUTO:PDSC:CDD?
Notes	Changes to this parameter will not be applied until Update Changes command is sent. See “RB Parameter Manager (Downlink)” on page 970 section for more details.
Dependencies	Always grayed out since this instrument supports only one RF input.
Preset	WOCDD
State Saved	Saved in instrument state.
Range	Without CDD Large Delay CDD
Initial S/W Revision	A.03.00

Codebook Index

Sets the Codebook Index number for spatial multiplexing precoding when Detection is Manual.

Key Path	Meas Setup, Channel Profile Setup, Edit User Mapping
Mode	LTE, LTETDD
Remote Command	[:SENSE] :EVM:DLINK:PROFile:USER1 50 :PDsch:CBIndex <integer> [:SENSE] :EVM:DLINK:PROFile:USER1 50 :PDsch:CBIndex?
Example	EVM:DLIN:PROF:USER1:PDSC:CBIN 1 EVM:DLIN:PROF:USER1:PDSC:CBIN?
Notes	Changes to this parameter will not be applied until Update Changes command is sent. See “RB Parameter Manager (Downlink)” on page 970 section for more details.

Dependencies	Max value of this parameter depends on Number of Tx Antenna. When Number of Tx Antenna is set to 2, Max value is 3. When Number of Tx Antenna is set to 4, Max value is 15. Enabled only when Detection is Manual, Number of Tx Antenna is set to more than 1, and Precoding is set to Spatial Multiplexing.
Couplings	Coupled with Number of Tx Antenna
Preset	0
State Saved	Saved in instrument state.
Min	0
Max	3 - when Number of Tx Antenna is set to 2 15 - when Number of Tx Antenna is set to 4
Initial S/W Revision	A.03.00

Auto Detect Codebook Index

Sets the Codebook Index number for spatial multiplexing precoding when Detection is Auto.

Key Path	Meas Setup, Channel Profile Setup, Edit User Mapping
Mode	LTE, LTETDD
Remote Command	[:SENSE]:EVM:DLINK:PROfile:AUTO:PDsch:CBINdex <integer> [:SENSe]:EVM:DLINK:PROfile:AUTO:PDsch:CBINdex?
Example	EVM:DLIN:PROF:AUTO:PDSC:CBIN 1 EVM:DLIN:PROF:AUTO:PDSC:CBIN?
Notes	Changes to this parameter will not be applied until Update Changes command is sent. See “RB Parameter Manager (Downlink)” on page 970 section for more details.
Dependencies	Max value of this parameter depends on Number of Tx Antenna. When Number of Tx Antenna is set to 2, Max value is 3. When Number of Tx Antenna is set to 4, Max value is 15. Enabled only when Detection is Auto, Precoding is set to Spatial Multiplexing and Number of Tx Antenna is set to more than 1.
Couplings	Coupled with Number of Tx Antenna
Preset	0
State Saved	Saved in instrument state.
Min	0
Max	3 - when Number of Tx Antenna is set to 2 15 - when Number of Tx Antenna is set to 4

LTE Modulation Analysis Measurement
Meas Setup (Measurement Setup)

Initial S/W Revision	A.03.00
----------------------	---------

OK/Cancel

Displays a menu that enables the changes to the parameters on the dialog to be applied or cancelled.

Mode	LTE, LTETDD
Initial S/W Revision	Prior to A.02.00
Modified at S/W Revision	A.03.00

OK

Applies all changes made to the parameters on the dialog then exits the dialog.

Mode	LTE, LTETDD
Initial S/W Revision	Prior to A.02.00
Modified at S/W Revision	A.03.00

Cancel

Cancels all changes made to the parameters on the dialog then exits the dialog.

Mode	LTE, LTETDD
Initial S/W Revision	Prior to A.02.00
Modified at S/W Revision	A.03.00

RB Parameter Manager (Downlink)

Reduces the time it takes to configure channel profile related parameters with SCPI commands.

The SCPI command parameters shown below are managed in this scheme.

Note that changes to the parameters are not applied until the Update Changes command is sent. See [“Update Changes \(Downlink\)” on page 973](#) section for more details.

[:SENSe]:EVM:DLINK:PROFile:ADD:USER
[:SENSe]:EVM:DLINK:PROFile:AUTO:PDSCh:CBINdex
[:SENSe]:EVM:DLINK:PROFile:AUTO:PDSCh:CDD
[:SENSe]:EVM:DLINK:PROFile:AUTO:PDSCh:NCODewords
[:SENSe]:EVM:DLINK:PROFile:AUTO:PDSCh:NLAYers
[:SENSe]:EVM:DLINK:PROFile:AUTO:PDSCh:PRECoding
[:SENSe]:EVM:DLINK:PROFile:AUTO:PDSCh:QAM16:CWONe:ENABLE
[:SENSe]:EVM:DLINK:PROFile:AUTO:PDSCh:QAM16:CWONe:PWRBoost

[[:SENSe]:EVM:DLINK:PROFile:AUTO:PDSCh:QAM16:CWZero:ENABle
[[:SENSe]:EVM:DLINK:PROFile:AUTO:PDSCh:QAM16:PWRBoost
[[:SENSe]:EVM:DLINK:PROFile:AUTO:PDSCh:QAM64:CWONe:ENABle
[[:SENSe]:EVM:DLINK:PROFile:AUTO:PDSCh:QAM64:CWONe:PWRBoost
[[:SENSe]:EVM:DLINK:PROFile:AUTO:PDSCh:QAM64:CWZero:ENABle
[[:SENSe]:EVM:DLINK:PROFile:AUTO:PDSCh:QAM64:PWRBoost
[[:SENSe]:EVM:DLINK:PROFile:AUTO:PDSCh:QPSK:CWONe:ENABle
[[:SENSe]:EVM:DLINK:PROFile:AUTO:PDSCh:QPSK:CWONe:PWRBoost
[[:SENSe]:EVM:DLINK:PROFile:AUTO:PDSCh:QPSK:CWZero:ENABle
[[:SENSe]:EVM:DLINK:PROFile:AUTO:PDSCh:QPSK:PWRBoost
[[:SENSe]:EVM:DLINK:PROFile:PBCH:PWRBoost
[[:SENSe]:EVM:DLINK:PROFile:PCFich:PWRBoost
[[:SENSe]:EVM:DLINK:PROFile:PDCCh:ALLocation:AUTO:DETECT
[[:SENSe]:EVM:DLINK:PROFile:PDCCh:ALLocation:CONSTant
[[:SENSe]:EVM:DLINK:PROFile:PDCCh:ALLocation:SUBFrame(0:9):SYMBOLs
[[:SENSe]:EVM:DLINK:PROFile:PDCCh:PWRBoost
[[:SENSe]:EVM:DLINK:PROFile:PDCCh:PWRBoost:STEP <rel_ampl>
[[:SENSe]:EVM:DLINK:PROFile:PHICH:ALLocation:RATIo
[[:SENSe]:EVM:DLINK:PROFile:PHICH:DESPread
[[:SENSe]:EVM:DLINK:PROFile:PHICH:DURation
[[:SENSe]:EVM:DLINK:PROFile:PHICH:PWRBoost
[[:SENSe]:EVM:DLINK:PROFile:PHICH:PWRBoost:STEP
[[:SENSe]:EVM:DLINK:PROFile:PSS:PWRBoost
[[:SENSe]:EVM:DLINK:PROFile:RS:PWRBoost
[[:SENSe]:EVM:DLINK:PROFile:SSS:PWRBoost
[[:SENSe]:EVM:DLINK:PROFile:USER(1:50):DECoded:PDSCh:CWZero:ENABle
[[:SENSe]:EVM:DLINK:PROFile:USER(1:50):DECoded:PDSCh:CWZero:PWRBoost
[[:SENSe]:EVM:DLINK:PROFile:USER(1:50):DECoded:PDSCh:CWONe:ENABle
[[:SENSe]:EVM:DLINK:PROFile:USER(1:50):DECoded:PDSCh:CWONe:PWRBoost
[[:SENSe]:EVM:DLINK:PROFile:USER(1:50):DELete

LTE Modulation Analysis Measurement
Meas Setup (Measurement Setup)

[:SENSe]:EVM:DLINK:PROFile:USER(1:50):PDSCh:ADD:ALLocation
[:SENSe]:EVM:DLINK:PROFile:USER(1:50):PDSCh:RBALloc(1:50):CWONe:MODulation:TYPE
[:SENSe]:EVM:DLINK:PROFile:USER(1:50):PDSCh:RBALloc(1:50):CWONe:PWRBoost
[:SENSe]:EVM:DLINK:PROFile:USER(1:50):PDSCh:RBALloc(1:50):DELete
[:SENSe]:EVM:DLINK:PROFile:USER(1:50):PDSCh:RBALloc(1:50):MODulation:TYPE
[:SENSe]:EVM:DLINK:PROFile:USER(1:50):PDSCh:RBALloc(1:50):PWRBoost
[:SENSe]:EVM:DLINK:PROFile:USER(1:50):PDSCh:RBALloc(1:50):RB:END
[:SENSe]:EVM:DLINK:PROFile:USER(1:50):PDSCh:RBALloc(1:50):RB:STARt
[:SENSe]:EVM:DLINK:PROFile:USER(1:50):PDSCh:RBALloc(1:50):SLOT:END
[:SENSe]:EVM:DLINK:PROFile:USER(1:50):PDSCh:RBALloc(1:50):SLOT:STARt
[:SENSe]:EVM:DLINK:PROFile:USER(1:50):PDSCh:CBINdex
[:SENSe]:EVM:DLINK:PROFile:USER(1:50):PDSCh:CDD
[:SENSe]:EVM:DLINK:PROFile:USER(1:50):PDSCh:CWONe:ENABLE
[:SENSe]:EVM:DLINK:PROFile:USER(1:50):PDSCh:CWONe:MODulation:TYPE
[:SENSe]:EVM:DLINK:PROFile:USER(1:50):PDSCh:CWONe:MODulation:TYPE:COUple
[:SENSe]:EVM:DLINK:PROFile:USER(1:50):PDSCh:CWONe:PWRBoost
[:SENSe]:EVM:DLINK:PROFile:USER(1:50):PDSCh:CWONe:PWRBoost:COUple
[:SENSe]:EVM:DLINK:PROFile:USER(1:50):PDSCh:CWZero:ENABLE
[:SENSe]:EVM:DLINK:PROFile:USER(1:50):PDSCh:MODulation:TYPE
[:SENSe]:EVM:DLINK:PROFile:USER(1:50):PDSCh:MODulation:TYPE:COUple
[:SENSe]:EVM:DLINK:PROFile:USER(1:50):PDSCh:NCODewords
[:SENSe]:EVM:DLINK:PROFile:USER(1:50):PDSCh:NLAYers
[:SENSe]:EVM:DLINK:PROFile:USER(1:50):PDSCh:PRECoding
[:SENSe]:EVM:DLINK:PROFile:USER(1:50):PDSCh:PWRBoost
[:SENSe]:EVM:DLINK:PROFile:USER(1:50):PDSCh:PWRBoost:COUple
[:SENSe]:EVM:DLINK:PROFile:USER(1:50):RNTI
[:SENSe]:EVM:DLINK:PROFile:USER(1:50):UERS:ACTive
[:SENSe]:EVM:DLINK:PROFile:USER(1:50):UERS:PWRBoost

This feature supports following operations:

- “[Update Changes \(Downlink\)](#)” on [page 973](#) command, which applies pending changes to parameters.
- “[Ignore Changes \(Downlink\)](#)” on [page 973](#) command, which discards pending changes to parameters.

- “Clear Changes (Downlink)” on page 973 command, which clears all existing RB mapping information for downlink.

The Update Changes and Ignore Changes commands behave similarly to the OK and Cancel buttons on user interface dialogs, respectively.

For example, to clear existing RB mapping information and configure one user with one allocation with RB End set to 49, send the following sequence in order. Note that the Clear Changes command is not required just after mode preset since there is no RB mapping information by default.

```
[ :SENSe]:EVM:DLINK:PROFile:CLEAr
[ :SENSe]:EVM:DLINK:PROFile:ADD:USER
[ :SENSe]:EVM:DLINK:PROFile:USER1:PDSCCh:ADD:ALLocation
[ :SENSe]:EVM:DLINK:PROFile:USER1:PDSCCh:RBALloc1:RB:END 49
[ :SENSe]:EVM:DLINK:PROFile:UPDate
```

Update Changes (Downlink)

SCPI Only. This command updates changes sent after last UPDate or preset.

Mode	LTE, LTETDD
Remote Command	[:SENSe]:EVM:DLINK:PROFile:UPDate
Example	EVM:DLIN:PROF:UPD
Initial S/W Revision	A.03.00

Clear Changes (Downlink)

SCPI Only. This command clears allocated resource blocks and deletes all Users.

Mode	LTE, LTETDD
Remote Command	[:SENSe]:EVM:DLINK:PROFile:CLEAr
Example	EVM:DLIN:PROF:CLE
Initial S/W Revision	A.03.00

Ignore Changes (Downlink)

SCPI Only. This command ignores (clears) changes which are not updated.

Mode	LTE, LTETDD
Remote Command	[:SENSe]:EVM:DLINK:PROFile:IGNore
Example	EVM:DLIN:PROF:IGN
Initial S/W Revision	A.03.00

LTE Modulation Analysis Measurement
Meas Setup (Measurement Setup)

Count Number of Users (Downlink)

SCPI Only. This command returns the number of added users.

Mode	LTE, LTETDD
Remote Command	[:SENSE]:EVM:DLINK:PROF:COUNT?
Example	EVM:DLIN:PROF:COUN?
Initial S/W Revision	A.03.00

Count Number of PDSCH Allocations (Downlink)

SCPI Only. This command returns the number of added PDSCH allocations.

Mode	LTE, LTETDD
Remote Command	[:SENSE]:EVM:DLINK:PROF:USER<n>:PDSCh:COUNT?
Example	EVM:DLIN:PROF:USER2:PDSC:COUN?
Dependencies	The range of sub op code <n> values is determined by the number of Users the user has configured. If the user attempts to remotely set or query a sub op code that is out of range, this will result in an error message.
Initial S/W Revision	A.03.00

Copy Auto -> Manual

Copies all autodetected allocations into the Resource Block Editor.

For downlink, when Copy Auto -> Manual is pressed, each autodetected modulation group will be assigned to a user. When RB Auto Detect Mode is set to Power Based, User_01 will contain resource blocks with QPSK; User_02 will contain resource blocks with 16QAM; and User_03 will contain resource blocks with 64QAM.

When RB Auto Detect Mode is set to Decode PDCCH, the user allocations will be copied into the LTE Allocation Editor as manual allocations.

For uplink, when Copy Auto -> Manual is pressed, User_01, which contains all autodetected channels, will be copied into the LTE Allocation Editor.

This key is useful when you have two signals with identical allocations, where one has a fairly good SNR, but the other has a low SNR. In this case, RB Auto Detect may detect the allocations for the noisy signal incorrectly. To work around this, you can recall the clean signal, autodetect allocations, and press Copy Auto -> Manual. Then you can recall the noisy signal and don't need to rely on auto detection.

Note that existing manual user mappings will be overwritten when you press this button.

Key Path	Meas Setup, Chan Profile Setup
Mode	LTE, LTETDD
Remote Command	[:SENSE]:EVM:PROF:COPY[:IMMEDIATE]

Example	EVM:PROF:COPY
Notes	Available when Detection is Auto.
Initial S/W Revision	A.06.00

Chan Profile Setup (Uplink)

Displays a menu of commonly used channel profile setup parameters when Direction is set to Uplink.

Key Path	Meas Setup
Mode	LTE, LTETDD
Initial S/W Revision	Prior to A.02.00
Modified at S/W Revision	A.03.00

Detection

See [“Detection” on page 884](#).

Key Path	Meas Setup, Chan Profile Setup
----------	---------------------------------------

Auto Detect Power Levels

Selects whether or not power levels are auto detected when Direction is Uplink.

When this parameter is set to on, the LTE demodulator will detect the relative uplink channel power levels for PUCCH, PUSCH, SRS and PRACH. When this parameter is set to off, the power levels for uplink channels will need to be specified.

Key Path	Meas Setup, Chan Profile Setup
Mode	LTE, LTETDD
Remote Command	[:SENSE]:EVM:ULINK:PROfile:AUTO[:DETECT]:POWER OFF ON 0 1 [:SENSE]:EVM:ULINK:PROfile:AUTO[:DETECT]:POWER?
Example	EVM:ULIN:PROF:AUTO:POW ON EVM:ULIN:PROF:AUTO:POW?
Dependencies	Available when Direction is Uplink and Detection is Auto.
Preset	OFF
State Saved	Saved in instrument state.
Range	On Off
Initial S/W Revision	A.10.00

LTE Modulation Analysis Measurement
Meas Setup (Measurement Setup)

Include Non Allocation

Includes inactive signals in the results.

Please refer to “[Include Non Allocation](#)” on page 893 for more details.

Key Path	Meas Setup, Chan Profile Setup
Mode	LTE, LTETDD

Composite Include (Uplink)

Displays a menu that enables inclusion or exclusion of all channels.

Key Path	Meas Setup, Chan Profile Setup
Mode	LTE, LTETDD
Initial S/W Revision	Prior to A.02.00
Modified at S/W Revision	A.03.00

Include All

Turns On all Uplink channels.

Key Path	Meas Setup, Chan Profile Setup, Composite Include
Mode	LTE, LTETDD
Remote Command	[:SENSe] :EVM:ULINk:PROFile:INCLude:ALL
Example	EVM:ULIN:PROF:INCL:ALL
Initial S/W Revision	Prior to A.02.00
Modified at S/W Revision	A.03.00

Exclude All

Turns Off all Uplink channels.

Key Path	Meas Setup, Chan Profile Setup, Composite Include
Mode	LTE, LTETDD
Remote Command	[:SENSe] :EVM:ULINk:PROFile:EXCLude:ALL
Example	EVM:ULIN:PROF:EXCLude:ALL

Couplings	Turns Off the following parameters if its state is On. Include PUSCH Include PUSCH DMRS Include PUCCH Include PUCCH DMRS Include PRACH Include S-RS Include Non Allocation
Initial S/W Revision	Prior to A.02.00
Modified at S/W Revision	A.03.00

Include Users (Uplink)

Displays a menu that enables you to determine which Uplink channels should be included in the results.

When Include is selected, the channel is displayed on applicable traces and also used in the process of Error Summary calculations. When Exclude is selected, only the Frame Summary trace will display information about this user's channel.

Key Path	Meas Setup, Chan Profile Setup, Include Users
Mode	LTE, LTETDD
Couplings	The Users shown on this softpanel are dependant on the number of Users defined. This menu will only display User1 when Detection is Auto. When Detection is Man, it will display all the defined Users
Initial S/W Revision	Prior to A.02.00
Modified at S/W Revision	A.03.00

User

Indexes the currently defined Users.

Key Path	Meas Setup, Chan Profile Setup, Include Users
Mode	LTE, LTETDD
Dependencies	Enabled when Detection is Manual.
Couplings	Max value determined by the number of Uplink Users the user has configured
Preset	0
State Saved	Saved in instrument state.
Min	1

LTE Modulation Analysis Measurement
Meas Setup (Measurement Setup)

Max	Determined by the number of Uplink Users the user has configured
Initial S/W Revision	Prior to A.02.00
Modified at S/W Revision	A.03.00

Include PUSCH

Includes PUSCH in the results.

Key Path	Meas Setup, Chan Profile Setup, Include Users
Mode	LTE, LTETDD
Remote Command	[:SENSE] :EVM:ULINK:PROF:USER<n>:PUSCh INCLude EXCLude [:SENSE] :EVM:ULINK:PROF:USER<n>:PUSCh?
Example	EVM:ULIN:PROF:USER1:PUSC INCL EVM:ULIN:PROF:USER1:PUSC?
Dependencies	The range of sub op code <n> values is determined by the number of Users the user has configured. If the user attempts to remotely set or query a sub op code that is out of range, this will result in an error message. Disabled when Detection is Auto, PUSCH Active is OFF or no slot is added. Only one user can be included at the same time.
Couplings	This parameter is set to Exclude when Uplink Exclude All is selected. When this parameter is set to Include, PUSCH of the other users and PRACH of all users are set to Exclude.
Preset	EXCLude
State Saved	Saved in instrument state.
Range	Include Exclude
Initial S/W Revision	Prior to A.02.00
Modified at S/W Revision	A.03.00

Include Auto Detect PUSCH

Includes Auto Detected PUSCH in the results.

Key Path	Meas Setup, Chan Profile Setup, Include Users
Mode	LTE, LTETDD
Remote Command	[:SENSE] :EVM:ULINK:PROF:AUTO:PUSCh INCLude EXCLude [:SENSE] :EVM:ULINK:PROF:AUTO:PUSCh?
Example	EVM:ULIN:PROF:AUTO:PUSC INCL EVM:ULIN:PROF:AUTO:PUSC?

Dependencies	Enabled when Detection is Auto and Auto Detect PUSCH Active is ON.
Couplings	This parameter is set to Exclude when Uplink Exclude All is selected. When this parameter is set to Include, Auto Detect PRACH is set to Exclude.
Preset	INCLude
State Saved	Saved in instrument state.
Range	Include Exclue
Initial S/W Revision	Prior to A.02.00
Modified at S/W Revision	A.03.00

Include PUSCH DMRS

Includes PUSCH DMRS in the results.

Key Path	Meas Setup, Chan Profile Setup, Include Users
Mode	LTE, LTETDD
Remote Command	[:SENSE] :EVM:ULINk:PROFile:USER<n>:PUSCh:DMRS INCLude EXCLude [:SENSE] :EVM:ULINk:PROFile:USER<n>:PUSCh:DMRS?
Example	EVM:ULIN:PROF:USER1:PUSC:DMRS INCL EVM:ULIN:PROF:USER1:PUSC:DMRS?
Dependencies	The range of sub op code <n> values is determined by the number of Users the user has configured. If the user attempts to remotely set or query a sub op code that is out of range, this will result in an error message. Enabled when Detection is Manual. Only one user can be included at the same time.
Couplings	This parameter is set to Exclude when Uplink Exclude All is selected. When this parameter is set to Include, PUSCH DMRS of the other users and PRACH of all users are set to Exclude.
Preset	EXCLude
State Saved	Saved in instrument state.
Range	Include Exclue
Initial S/W Revision	Prior to A.02.00
Modified at S/W Revision	A.03.00

Include Auto Detect PUSCH DMRS

Includes Auto Detected PUSCH DMRS in the results.

Key Path	Meas Setup, Chan Profile Setup, Include Users
Mode	LTE, LTETDD
Remote Command	[:SENSe] :EVM:ULINk:PROFile:AUTO:PUSCh:DMRS INCLude EXCLude [:SENSe] :EVM:ULINk:PROFile:AUTO:PUSCh:DMRS?
Example	EVM:ULIN:PROF:AUTO:PUSC:DMRS INCL EVM:ULIN:PROF:AUTO:PUSC:DMRS?
Dependencies	Enabled when Detection is Auto.
Couplings	This parameter is set to Exclude when Uplink Exclude All is selected. When this parameter is set to Include, Auto Detect PRACH is set to Exclude.
Preset	INCLude
State Saved	Saved in instrument state.
Range	Include Exclude
Initial S/W Revision	Prior to A.02.00
Modified at S/W Revision	A.03.00

Include PUCCH

Includes PUCCH in the results.

Key Path	Meas Setup, Chan Profile Setup, Include Users
Mode	LTE, LTETDD
Remote Command	[:SENSe] :EVM:ULINk:PROFile:USER<n>:PUCCh INCLude EXCLude [:SENSe] :EVM:ULINk:PROFile:USER<n>:PUCCh?
Example	EVM:ULIN:PROF:USER1:PUCCL INCL EVM:ULIN:PROF:USER1:PUCCL?
Dependencies	The range of sub op code <n> values is determined by the number of Users the user has configured. If the user attempts to remotely set or query a sub op code that is out of range, this will result in an error message. Enabled when PUCCH Active is ON, one or more slots are added, and Detection is Manual. Only one user can be included at the same time.

Couplings	This parameter is set to Exclude when Uplink Exclude All is selected. When this parameter is set to Include, PUCCH of another user, PUSCH, PRACH and S-RS are set to Exclude.
Preset	EXCLude
State Saved	Saved in instrument state.
Range	Include Exclude
Initial S/W Revision	Prior to A.02.00
Modified at S/W Revision	A.03.00

Include Auto Detect PUCCH

Includes Auto Detected PUCCH in the results.

Key Path	Meas Setup, Chan Profile Setup, Include Users
Mode	LTE, LTETDD
Remote Command	[:SENSE]:EVM:ULINK:PROFile:AUTO:PUCCh INCLude EXCLude [:SENSE]:EVM:ULINK:PROFile:AUTO:PUCCh?
Example	EVM:ULIN:PROF:AUTO:PUCCL INCL EVM:ULIN:PROF:AUTO:PUCCL?
Dependencies	Enabled when Detection is Auto and Auto Detect PUCCH Active is ON.
Couplings	This parameter is set to Exclude when Uplink Exclude All is selected. When this parameter is set to Include, Auto Detect PRACH is set to Exclude.
Preset	EXCLude
State Saved	Saved in instrument state.
Range	Include Exclude
Initial S/W Revision	Prior to A.02.00
Modified at S/W Revision	A.03.00

Include PUCCH DMRS

Includes PUCCH DMRS in the results.

Key Path	Meas Setup, Chan Profile Setup, Include Users
Mode	LTE, LTETDD
Remote Command	[:SENSE]:EVM:ULINK:PROFile:USER<n>:PUCCh:DMRS INCLude EXCLude [:SENSE]:EVM:ULINK:PROFile:USER<n>:PUCCh:DMRS?

LTE Modulation Analysis Measurement
Meas Setup (Measurement Setup)

Example	EVM:ULIN:PROF:USER1:PUC:DMRS INCL EVM:ULIN:PROF:USER1:PUC:DMRS?
Dependencies	The range of sub op code <n> values is determined by the number of Users the user has configured. If the user attempts to remotely set or query a sub op code that is out of range, this will result in an error message. Enabled when Detection is Manual. Only one user can be included at the same time.
Couplings	This parameter is set to Exclude when Uplink Exclude All is selected. When this parameter is set to Include, PUCCH DMRS of the other users and PRACH of all users are set to Exclude.
Preset	EXCLude
State Saved	Saved in instrument state.
Range	Include Exclude
Initial S/W Revision	Prior to A.02.00
Modified at S/W Revision	A.03.00

Include Auto Detect PUCCH DMRS

Includes Auto Detected PUSCH DMRS in the results.

Key Path	Meas Setup, Chan Profile Setup, Include Users
Mode	LTE, LTETDD
Remote Command	[:SENSe] :EVM:ULINK:PROF:le:AUTO:PUCCh:DMRS INCLude EXCLude [:SENSe] :EVM:ULINK:PROF:le:AUTO:PUCCh:DMRS?
Example	EVM:ULIN:PROF:AUTO:PUC:DMRS INCL EVM:ULIN:PROF:AUTO:PUC:DMRS?
Dependencies	Enabled when Detection is Auto.
Couplings	This parameter is set to Exclude when Uplink Exclude All is selected. When this parameter is set to Include, Auto Detect PRACH is set to Exclude.
Preset	EXCLude
State Saved	Saved in instrument state.
Range	Include Exclude
Initial S/W Revision	Prior to A.02.00
Modified at S/W Revision	A.03.00

Include PRACH

Includes PRACH in the results.

Key Path	Meas Setup, Chan Profile Setup, Include Users
Mode	LTE, LTETDD
Remote Command	[:SENSe] :EVM:ULINk:PROFile:USER<n>:PRACH INCLude EXCLude [:SENSe] :EVM:ULINk:PROFile:USER<n>:PRACH?
Example	EVM:ULIN:PROF:USER1:PRAC INCL EVM:ULIN:PROF:USER1:PRAC?
Dependencies	The range of sub op code <n> values is determined by the number of Users the user has configured. If the user attempts to remotely set or query a sub op code that is out of range, this will result in an error message. Enabled when Direction is Manual and PRACH Active is ON.
Couplings	This parameter is set to Exclude when Uplink Exclude All is selected. When this parameter is set to Include, PUSCH, PUCCH and S-RS are set to Exclude.
Preset	EXCLude
State Saved	Saved in instrument state.
Range	Include Exclude
Initial S/W Revision	A.03.00

Include Auto Detect PRACH

Includes Auto Detected PRACH in the results.

Key Path	Meas Setup, Chan Profile Setup, Include Users
Mode	LTE, LTETDD
Remote Command	[:SENSe] :EVM:ULINk:PROFile:AUTO:PRACH INCLude EXCLude [:SENSe] :EVM:ULINk:PROFile:AUTO:PRACH?
Example	EVM:ULIN:PROF:AUTO:PRAC INCL EVM:ULIN:PROF:AUTO:PRAC?
Dependencies	Enabled when Detection is Auto and Auto Detect PRACH Active is ON.
Couplings	This parameter is set to Exclude when Uplink Exclude All is selected. When this parameter is set to Include, Auto Detect PUCCH, Auto Detect PUSCH and Auto Detect S-RS are set to Exclude.

LTE Modulation Analysis Measurement
Meas Setup (Measurement Setup)

Preset	EXCLude
State Saved	Saved in instrument state.
Range	Include Exclude
Initial S/W Revision	A.03.00

Include S-RS

Includes S-RS in the results.

Key Path	Meas Setup, Chan Profile Setup, Include Users
Mode	LTE, LTETDD
Remote Command	[:SENSe] :EVM:ULINk:PROFile:USER<n>:SRS INCLude EXCLude [:SENSe] :EVM:ULINk:PROFile:USER<n>:SRS?
Example	EVM:ULIN:PROF:USER1:SRS INCL EVM:ULIN:PROF:USER1:SRS?
Dependencies	The range of sub op code <n> values is determined by the number of Users the user has configured. If the user attempts to remotely set or query a sub op code that is out of range, this will result in an error message. Enabled when Detection is Manual and S-RS Active is ON.
Couplings	This parameter is set to Exclude when Uplink Exclude All is selected. When this parameter is set to Include, PRACH is set to Exclude.
Preset	EXCLude
State Saved	Saved in instrument state.
Range	Include Exclude
Initial S/W Revision	A.03.00

Include Auto Detect S-RS

Includes Auto Detected S-RS in the results.

Key Path	Meas Setup, Chan Profile Setup, Include Users
Mode	LTE, LTETDD
Remote Command	[:SENSe] :EVM:ULINk:PROFile:AUTO:SRS INCLude EXCLude [:SENSe] :EVM:ULINk:PROFile:AUTO:SRS?
Example	EVM:ULIN:PROF:AUTO:SRS INCL EVM:ULIN:PROF:AUTO:SRS?

Dependencies	Enabled when Detection is Auto and Auto Detect S-RS Active is ON.
Couplings	This parameter is set to Exclude when Uplink Exclude All is selected. When this parameter is set to Include, Auto Detect PRACH is set to Exclude.
Preset	EXCLude
State Saved	Saved in instrument state.
Range	Include Exclude
Initial S/W Revision	A.03.00

Edit User Mapping (Uplink)

Displays the LTE Allocation Editor that enables you to edit the Downlink channel parameters. When a parameter is selected, the corresponding softkeys will appear.

- Use **Tab** key to select a parameter field to edit. The rotary knob can be also used to select a parameter field as it has two functions: value adjustment (default) and field navigation. Use **Enter** key to toggle the function.
- In order to apply or discard changes, select OK button or Cancel button on the editor to show the corresponding softkeys and press either of them. These softkeys also appear by pressing **Cancel (Esc)** key when the active function is disabled.

NOTE If Help is open when you select this key, the dialog and menu does not appear. Close Help by pressing **Cancel (Esc)**, then select this key. After the menu has changed, press the green **Help** key to see Help for the dialog and keys. Close Help when you are ready to edit the parameters.

Key Path	Meas Setup, Chan Profile Setup, More, More
Mode	LTE, LTETDD
Initial S/W Revision	Prior to A.02.00
Modified at S/W Revision	A.03.00, A.06.00

This table lists all the parameters available to set up uplink user PUSCH, PUCCH, PRACH and S-RS user Parameters.

Parameter	Description
-----------	-------------

LTE Modulation Analysis Measurement
Meas Setup (Measurement Setup)

Detection	<p>When enabled, the demodulator can autodetect PUSCH, PUCCH, PRACH or S-RS when a sync slot is specified. A unique sync slot is necessary for determining the frame boundary, but not for successful demodulation.</p> <p>To specify a unique sync slot for PUSCH, make sure the PUSCH tab is active, then specify the Channel Parameters and Per-slot parameters for the sync slot.</p> <p>To specify a unique slot for PUCCH, make sure the PUCCH tab is active, then specify the Sync Slot number and the Per-subframe parameters for the PUCCH sync slot.</p> <p>To specify a unique slot for S-RS, make sure the S-RS tab is active, then specify the Sync Slot number for the S-RS sync.</p>
Auto Detect Power Levels	Selects whether or not power levels are auto detected. Enabled only when Detection is Auto.
Cell ID	Sets the uplink user's physical-layer Cell ID.
RNTI	Sets the uplink user's radio network temporary identifier.
Frame Number	Sets uplink user's System Frame Number.
Group Hopping	Determines whether group hopping is enabled. This parameter is available to be set only if DMRS Parameters is selected. Enabling group hopping disables sequence hopping.
Seq Hopping	Determines whether sequence hopping is enabled. This parameter is available to be set only if DMRS Parameters is selected. Enabling sequence hopping disables group hopping.
Include PUSCH	When selected, PUSCH for the selected user is displayed on appropriate traces. When cleared, only the "Frame Summary" on page 1196 trace will display information about this user's PUSCH channel.
Include PUCCH	When selected, PUCCH for the selected user is displayed on appropriate traces. When cleared, only the "Frame Summary" on page 1196 trace will display information about this user's PUCCH channel.
Include PRACH	When selected, PRACH for the selected user is displayed on appropriate traces. When cleared, only the "Frame Summary" on page 1196 trace will display information about this user's PRACH.
Include S-RS	When selected, S-RS for the selected user is displayed on appropriate traces. When cleared, only the "Frame Summary" on page 1196 trace will display information about this user's S-RS.
Add	Adds a user allocation.
Delete	Deletes the selected user allocation.
PUSCH Channel Parameters	
DMRS Parameters	Selecting this parameter causes DMRS Group, DMRS Seq, and DMRS Cyclic Shift to be set automatically using the following three parameters.
$n_{\text{DMRS}(1)}$	Specifies the value of $n_{\text{DMRS}(1)}$ used by the selected user mapping.
$n_{\text{DMRS}(2)}$	Specifies the value of $n_{\text{DMRS}(2)}$ used by the selected user mapping.

ΔSS	Specifies the value of ΔSS used by the selected user mapping.
Frequency Hopping	Sets the frequency hopping or disables frequency hopping. This key is used in combination with Frequency Hopping Mode.
Frequency Hopping Mode	Sets the frequency hopping. This key is used in combination with Frequency Hopping.
Hopping Offset	Specifies the value of Hopping Offset (N_{RB}^{HO}). Hopping Offset is the offset used for PUSCH frequency hopping, expressed in number of resource blocks (set by higher layer). (3GPP TS 36.211 V8.5.0 5.3.4)
Number of Sub-bands	Specifies the value of number of sub-bands (N_{sb}). (3GPP TS 36.211 V8.5.0 5.3.4)
PUSCH Per-Slot Parameters	
Couple	Selecting the checkbox next to a parameter will couple that parameter across all RB allocation groups for a user.
RB Start	Specifies the RB start boundary.
RB End	Specifies the RB end boundary.
Mod Type	Modulation type: QPSK, QAM16, or QAM64.
Power (dB)	Sets the PUCCH average power level relative to the 0 dB point set by the PUCCH DMRS Power.
DMRS Group (u)	Specifies the DMRS Group (u) for a slot.
DMRS Seq (v)	Specifies the DMRS Sequence (v) for a slot.
DMRS Cyclic Shift	Specifies the DMRS Cyclic Shift for a slot.
DMRS Power (dB)	Specifies the value to set DMRS Power equal to for a slot. PUSCH power is set relative to the 0 dB point determined by this parameter. For example, setting DMRS Power = 2 dB and PUSCH Power = 0.1 dB means that the demodulator will expect PUSCH average power level to be 1.9 dB below the average DMRS power level.
CUR_TX_NB	CURRENT_TX_NB specifies whether or not allocation is mirrored.
Add	Adds a slot allocation.
Delete	Deletes the selected slot allocation.
Slot Up	Moves the selected slot allocation up in time (increasing slot number) to the closest available slot allocation for a user.

LTE Modulation Analysis Measurement
Meas Setup (Measurement Setup)

Slot Down	Moves the selected slot allocation down in time (decreasing slot number) to the closest available slot allocation for a user.
PUCCH Channel Parameters	
DMRS Parameters	Selecting this parameter causes DMRS Group, DMRS Seq, and DMRS Cyclic Shift of PUCCH to be set automatically using the following six parameters.
$N_{RB}(2)$	Specifies the value of $N_{RB}(2)$ used by the selected user mapping, $N_{RB}(2)$ indicates the bandwidth reserved for PUCCH 2/2a/2b, expressed in multiples of $N_{SC}RB$.
$N_{CS}(1)$	Specifies the value of $N_{CS}(1)$ used by the selected user mapping, $N_{CS}(1)$ indicates the number of cyclic shifts used for PUCCH formats 1/1a/1b in a resource block with a mix of formats 1/1a/1b and 2/2a/2b.
$n_{PUCCH}(2)$	Specifies the value of $n_{PUCCH}(2)$ used by the selected user mapping, $n_{PUCCH}(2)$ indicates the resource index for PUCCH formats 2/2a/2b
$shift^{PUCCH}$	Specifies the value of $shift^{PUCCH}$ used by the selected user mapping
Format/ $n_{PUCCH}(1)$	Enables auto detection of PUCCH Format and $n_{PUCCH}(1)$ for all subframes. This is useful when the format and/or $n_{PUCCH}(1)$ value is different for each subframe.
PUCCH Per-Subframe Parameters	
First RB	<p>Sets the RB index of the selected user's PUCCH allocation for this slot. The next or previous (see Notes below) slot's PUCCH allocation will automatically be set according to the LTE standard (mirrored in frequency).</p> <p>For example, in a 5 MHz LTE signal (25 RBs), when Slot 0 contains a PUCCH allocation at RB 0, Slot 1 will be set to have a PUCCH allocation at RB 24.</p> <p>Notes</p> <p>A user can only have one RB allocated to PUCCH per slot.</p> <p>When Auto Detection is selected and Sync Slot is odd, this parameter sets the RB index for the second slot in a PUCCH subframe, causing the previous (instead of the next) slot to contain a mirrored PUCCH allocation for the current user.</p>
Format	Sets the PUCCH type. Supported types are Type1, Type 1a, Type 1b, Type 2, Type 2a, Type 2b, Type 1 Short, Type 1a Short, Type 1b Short.
Cyclic Shift	Sets PUCCH cyclic shift.
OS	Sets the Orthogonal Sequence index for PUCCH.
Power (dB)	Sets the PUCCH average power level relative to the 0 dB point set by the PUCCH DMRS Power.
DMRS Group (u)	Sets the group number for the PUCCH demodulation reference signal (DMRS).

DMRS Power (dB)	Sets the power level for the PUCCH demodulation reference signal (DMRS) during the selected subframe. PUCCH Power is set relative to the 0 dB point determined by this parameter. For example, setting DMRS Power = 2 dB and PUCCH Power = 0.1 dB means that the demodulator will expect PUCCH average power level to be 1.9 dB below the average DMRS power level.
$n_{\text{PUCCH}}(1)$	Specifies the value of $n_{\text{PUCCH}}(1)$ used by the selected user mapping, $n_{\text{PUCCH}}(1)$ indicates the resource index for PUCCH formats 1/1a/1b
Add	Adds a subframe allocation.
Delete	Deletes the selected subframe allocation.
Subframe Up	Moves the selected subframe allocation up in time (increasing subframe number) to the closest available subframe allocation for a user.
Subframe Down	Moves the selected subframe allocation down in time (decreasing subframe number) to the closest available subframe allocation for a user.
PRACH Channel Parameters (3GPP TS 36.211 5.7)	
Resource Block Offset	Sets offset for first physical resource block occupied by PRACH resource considered ($n_{\text{PRB}}^{\text{RA}}$).
Configuration Index	Sets PRACH Configuration Index to give frame structure.
Logical Root Sequence Index	Sets Logical Root Sequence Index to give root Zadoff-Chu sequence order.
Cyclic Shift Set	Sets Unrestricted or Restricted to give N_{CS} (Number of Cyclic Shifts) for PRACH preamble sequence generation. Value of N_{CS} will be determined by this selection and N_{CS} Configuration.
N_{CS} Configuration	Sets a value to give N_{CS} (Number of Cyclic Shifts) PRACH preamble sequence generation. Value of N_{CS} will be determined by this value and Cyclic Shift Set.
Preamble Index	Sets a value to give cyclic shift for PRACH preamble sequence generation.
Sync Resource (TDD only)	For a specific combination of PRACH configuration index and UL/DL configuration, there will be one or multiple random access resources for UE to use, this parameter sets the index of corresponding random access resource used as synchronization reference for measurement algorithm. 3GPP TS 36.211 V8.5.0 5.7 listed the random access preamble mapping in Table 5.7.1-4.
Power	Sets the PRACH average power level relative to the 0 dB point set by the PRACH Power.
S-RS Channel Parameters (3GPP TS 36.211 5.5.3)	

LTE Modulation Analysis Measurement
Meas Setup (Measurement Setup)

Cyclic Shift	Sets n_{SRS}^{CS} value to get Cyclic Shift alpha.
BW Config	Sets S-RS Bandwidth Configuration (C_{SRS}).
BW	Sets S-RS Bandwidth (B_{SRS}).
Tx Comb	Sets Transmission Comb (k_{TC}) of S-RS.
Hopping BW	Sets S-RS Hopping Bandwidth.
Freq Domain Position	Sets S-RS Frequency Domain Position (n_{RRC}).
Subframe Config	Sets S-RS Subframe Configuration.
Power	Sets the S-RS average power level relative to the 0 dB point set by the S-RS Power.
MaxUp PTS	Enables you to give the value of <code>srsMaxUpPts</code> to indicate whether or not $m_{SRS,0}$ reconfiguration is enabled for UpPTS
Config Index	Sets S-RS Configuration Index (I_{SRS}). (3GPP TS 36.213 V8.5.0 8.2 Table 8.2-1~2)

Detection

See [“Detection” on page 884](#)

Key Path	Meas Setup, Chan Profile Setup, Edit User Mapping
----------	--

Auto Detect Power Levels (Uplink)

See [“Auto Detect Power Levels” on page 975](#).

Add User

Adds a new User and the new entry becomes the selected User. The new User will have all parameters of its channels set to the default values.

Key Path	Meas Setup, Chan Profile Setup, Edit User Mapping, Users
Mode	LTE, LTETDD
Remote Command	[:SENSe] :EVM:ULINK:PROF:ADD:USER
Example	EVM:ULIN:PROF:ADD:USER
Notes	Changes to this parameter will not be applied until Update Changes command is sent. See “RB Parameter Manager (Uplink)” on page 1118 section for more details.
Dependencies	The new User will be added at the end of the currently defined Users. Disabled once the number of Slots reaches to 50, the max number.

Initial S/W Revision	Prior to A.02.00
Modified at S/W Revision	A.03.00

Delete User

Deletes the current selected User.

Key Path	Meas Setup, Chan Profile Setup, Edit User Mapping, User
Mode	LTE, LTETDD
Remote Command	[:SENSe] :EVM:ULINk:PROFile:USER<n>:DELeTe
Example	EVM:ULIN:PROF:USER1:DEL
Notes	Once a User is deleted, subsequent Users will be renumbered to keep User numbering sequential
Notes	Changes to this parameter will not be applied until Update Changes command is sent. See “RB Parameter Manager (Uplink)” on page 1118 section for more details.
Dependencies	The range of sub op code (n) values is determined by the number of Users the user has configured. If the user attempts to remotely delete a sub op code that is out of range, this will result in an error message. Disabled when there is only one User.
Initial S/W Revision	Prior to A.02.00
Modified at S/W Revision	A.03.00

Cell ID

Sets uplink user's physical-layer Cell ID when Detection is Man.

Key Path	Meas Setup, Chan Profile Setup, Edit User Mapping
Mode	LTE, LTETDD
Remote Command	[:SENSe] :EVM:ULINk:PROFile:USER<n>:CID <integer> [:SENSe] :EVM:ULINk:PROFile:USER<n>:CID?
Example	EVM:ULIN:PROF:USER1:CID 1 EVM:ULIN:PROF:USER1:CID?
Notes	Changes to this parameter will not be applied until Update Changes command is sent. See “RB Parameter Manager (Uplink)” on page 1118 section for more details.
Dependencies	The range of sub op code <n> values is determined by the number of Users the user has configured. If the user attempts to remotely set or query a sub op code that is out of range, this will result in an error message Enabled when Detection is Manual.

LTE Modulation Analysis Measurement
Meas Setup (Measurement Setup)

Preset	0
State Saved	Saved in instrument state.
Min	0
Max	503
Initial S/W Revision	Prior to A.02.00
Modified at S/W Revision	A.03.00

Auto Detect Cell ID

Sets uplink user's physical-layer Cell ID when Detection is Auto.

Key Path	Meas Setup, Chan Profile Setup, Edit User Mapping, Cell ID
Mode	LTE, LTETDD
Remote Command	[:SENSe]:EVM:ULINk:PROFile:AUTO:CID <integer> [:SENSe]:EVM:ULINk:PROFile:AUTO:CID?
Example	EVM:ULIN:PROF:AUTO:CID 1 EVM:ULIN:PROF:AUTO:CID?
Notes	Changes to this parameter will not be applied until Update Changes command is sent. See “RB Parameter Manager (Uplink)” on page 1118 section for more details.
Dependencies	Enabled when Detection is Auto.
Preset	0
State Saved	Saved in instrument state.
Min	0
Max	503
Initial S/W Revision	Prior to A.02.00
Modified at S/W Revision	A.03.00

RNTI

Sets uplink user's radio network temporary identifier.

Key Path	Meas Setup, Chan Profile Setup, Edit User Mapping
Mode	LTE, LTETDD
Remote Command	[:SENSe]:EVM:ULINk:PROFile:USER<n>:RNTI <integer> [:SENSe]:EVM:ULINk:PROFile:USER<n>:RNTI?

Example	EVM:ULIN:PROF:USER1:RNTI 1 EVM:ULIN:PROF:USER1:RNTI?
Notes	Changes to this parameter will not be applied until Update Changes command is sent. See “RB Parameter Manager (Uplink)” on page 1118 section for more details.
Dependencies	The range of sub op code <n> values is determined by the number of Users the user has configured. If the user attempts to remotely set or query a sub op code that is out of range, this will result in an error message. Available when Direction is Uplink and Detection is Manual.
Preset	0
State Saved	Saved in instrument state.
Min	0
Max	65535
Initial S/W Revision	A.06.00

Auto Detect RNTI

Sets uplink user's radio network temporary identifier.

Key Path	Meas Setup, Chan Profile Setup, Edit User Mapping
Mode	LTE, LTETDD
Remote Command	[:SENSe]:EVM:ULINk:PROFile:AUTO:RNTI <integer> [:SENSe]:EVM:ULINk:PROFile:AUTO:RNTI?
Example	EVM:ULIN:PROF:AUTO:RNTI 1 EVM:ULIN:PROF:AUTO:RNTI?
Notes	Changes to this parameter will not be applied until Update Changes command is sent. See “RB Parameter Manager (Uplink)” on page 1118 section for more details.
Dependencies	Available when Direction is Uplink and Detection is Auto.
Preset	0
State Saved	Saved in instrument state.
Min	0
Max	65535
Initial S/W Revision	A.06.00

System Frame Number

Sets uplink user's System Frame Number when Detection is Man.

Key Path	Meas Setup, Chan Profile Setup, Edit User Mapping
Mode	LTE, LTETDD
Remote Command	[:SENSe] :EVM:ULINk:PROFile:USER<n>:SFNumber <integer> [:SENSe] :EVM:ULINk:PROFile:USER<n>:SFNumber?
Example	EVM:ULIN:PROF:USER1:SFN 0 EVM:ULIN:PROF:USER1:SFN?
Notes	Changes to this parameter will not be applied until Update Changes command is sent. See “RB Parameter Manager (Uplink)” on page 1118 section for more details.
Dependencies	The range of sub op code <n> values is determined by the number of Users the user has configured. If the user attempts to remotely set or query a sub op code that is out of range, this will result in an error message. Enabled when Detection is Manual.
Preset	0
State Saved	Saved in instrument state.
Min	0
Max	1023
Initial S/W Revision	A.03.00

Auto Detect System Frame Number

Sets uplink user's System Frame Number when Detection is Auto.

Key Path	Meas Setup, Chan Profile Setup, Edit User Mapping
Mode	LTE, LTETDD
Remote Command	[:SENSe] :EVM:ULINk:PROFile:AUTO:SFNumber <integer> [:SENSe] :EVM:ULINk:PROFile:AUTO:SFNumber?
Example	EVM:ULIN:PROF:AUTO:SFN 0 EVM:ULIN:PROF:AUTO:SFN?
Notes	Changes to this parameter will not be applied until Update Changes command is sent. See “RB Parameter Manager (Uplink)” on page 1118 section for more details.
Dependencies	Enabled when Detection is Auto.
Preset	0

State Saved	Saved in instrument state.
Min	0
Max	1023
Initial S/W Revision	A.03.00

Group Hopping

Determines if Group Hopping is enabled when Detection is Manual.

Key Path	Meas Setup, Chan Profile Setup, Edit User Mapping, Group Hopping
Mode	LTE, LTETDD
Remote Command	[:SENSe] :EVM:ULINk:PROfile:USER<n>:HOpping:GROup OFF ON 0 1 [:SENSe] :EVM:ULINk:PROfile:USER<n>:HOpping:GROup?
Example	EVM:ULIN:PROF:USER1:HOPP:GRO OFF EVM:ULIN:PROF:USER1:HOPP:GRO?
Notes	Changes to this parameter will not be applied until Update Changes command is sent. See “RB Parameter Manager (Uplink)” on page 1118 section for more details.
Dependencies	Enabled when Detection is Manual.
Couplings	Enabling Group Hopping disables Sequence Hopping.
Preset	OFF
State Saved	Saved in instrument state.
Initial S/W Revision	Prior to A.02.00
Modified at S/W Revision	A.03.00

Auto Detect Group Hopping

Determines if Group Hopping is enabled when Detection is Auto.

Key Path	Meas Setup, Chan Profile Setup, Edit User Mapping, Group Hopping
Mode	LTE, LTETDD
Remote Command	[:SENSe] :EVM:ULINk:PROfile:AUTO:HOpping:GROup OFF ON 0 1 [:SENSe] :EVM:ULINk:PROfile:AUTO:HOpping:GROup?
Example	EVM:ULIN:PROF:AUTO:HOPP:GRO OFF EVM:ULIN:PROF:USER1:HOPP:GRO?

LTE Modulation Analysis Measurement
Meas Setup (Measurement Setup)

Notes	Changes to this parameter will not be applied until Update Changes command is sent. See “RB Parameter Manager (Uplink)” on page 1118 section for more details.
Dependencies	Enabled when Detection is Auto
Couplings	Enabling Group Hopping disables Sequence Hopping.
Preset	OFF
State Saved	Saved in instrument state.
Initial S/W Revision	Prior to A.02.00
Modified at S/W Revision	A.03.00

Seq Hopping

Determines if Seq Hopping is enabled when Detection is Manual.

Key Path	Meas Setup, Chan Profile Setup, Edit User Mapping, Seq Hopping
Mode	LTE, LTETDD
Remote Command	[:SENSe] :EVM:ULINk:PROFile:USER<n>:HOPping:SEQuence OFF ON 0 1 [:SENSe] :EVM:ULINk:PROFile:USER<n>:HOPping:SEQuence?
Example	EVM:ULIN:PROF:USER1:HOPP:SEQ OFF EVM:ULIN:PROF:USER1:HOPP:SEQ?
Notes	Changes to this parameter will not be applied until Update Changes command is sent. See “RB Parameter Manager (Uplink)” on page 1118 section for more details.
Dependencies	The range of sub op code <n> values is determined by the number of Users the user has configured. Enabled when Detection is Manual.
Couplings	Enabling Sequence Hopping disables Group Hopping.
Preset	OFF
State Saved	Saved in instrument state.
Initial S/W Revision	Prior to A.02.00
Modified at S/W Revision	A.03.00

Auto Detect Seq Hopping

Determines if Seq Hopping is enabled when Detection is Auto.

Key Path	Meas Setup, Chan Profile Setup, Edit User Mapping, Seq Hopping
Mode	LTE, LTETDD

Remote Command	[:SENSE]:EVM:ULINK:PROfile:AUTO:HOPping:SEquence OFF ON 0 1 [:SENSE]:EVM:ULINK:PROfile:AUTO:HOPping:SEquence?
Example	EVM:ULIN:PROF:AUTO:HOPP:SEQ OFF EVM:ULIN:PROF:AUTO:HOPP:SEQ?
Notes	Changes to this parameter will not be applied until Update Changes command is sent. See “RB Parameter Manager (Uplink)” on page 1118 section for more details.
Dependencies	Enabled when Detection is Auto.
Couplings	Enabling Sequence Hopping disables Group Hopping.
Preset	OFF
State Saved	Saved in instrument state.
Initial S/W Revision	Prior to A.02.00
Modified at S/W Revision	A.03.00

Include PUSCH

Refer to sections [“Include PUSCH ”](#) on page 978 and [“Include Auto Detect PUSCH ”](#) on page 978.

Mode	LTE, LTETDD
Initial S/W Revision	Prior to A.02.00
Modified at S/W Revision	A.03.00

Include PUCCH

Refer to sections [“Include PUCCH ”](#) on page 980 and [“Include Auto Detect PUCCH ”](#) on page 981.

Mode	LTE, LTETDD
Initial S/W Revision	Prior to A.02.00
Modified at S/W Revision	A.03.00

Include PRACH

Refer to section [“Include PRACH”](#) on page 983RACH and [“Include Auto Detect PRACH”](#) on page 983RACH.

Mode	LTE, LTETDD
Initial S/W Revision	A.03.00

LTE Modulation Analysis Measurement
Meas Setup (Measurement Setup)

Include S-RS

Refer to section “[Include S-RS](#)” on page 984S-RS and “[Include Auto Detect S-RS](#)” on page 984S-RS.

Mode	LTE, LTETDD
Initial S/W Revision	A.03.00

PUSCH Parameters

Displays a menu that enables you to select PUSCH parameters for signals.

Key Path	Meas Setup, Chan Profile Setup, Edit User Mapping, PUSCH Parameters
Mode	LTE, LTETDD
Initial S/W Revision	Prior to A.02.00
Modified at S/W Revision	A.03.00

PUSCH Active

Selects whether or not PUSCH exists in the input signal when Detection is Manual.

Key Path	Meas Setup, Chan Profile Setup, Edit User Mapping
Mode	LTE, LTETDD
Remote Command	[:SENSe] :EVM:ULINk:PROFile:USER1 50:PUSCh:ACTive OFF ON 0 1 [:SENSe] :EVM:ULINk:PROFile:USER1 50:PUSCh:ACTive?
Example	EVM:ULIN:PROF:USER1:PUSC:ACT OFF EVM:ULIN:PROF:USER1:PUSC:ACT?
Notes	Changes to this parameter will not be applied until Update Changes command is sent. See “ RB Parameter Manager (Uplink) ” on page 1118 section for more details.
Dependencies	Enabled when Detection is Manual. All softkeys for PUSCH parameters are grayed out when this parameter is set to OFF.
Preset	OFF
State Saved	Saved in instrument state.
Initial S/W Revision	A.03.00

Auto Detect PUSCH Active

Selects whether or not PUSCH exists in the input signal when Detection is Auto.

Key Path	Meas Setup, Chan Profile Setup, Edit User Mapping
----------	--

Mode	LTE, LTETDD
Remote Command	[:SENSe] :EVM:ULINk:PROFile:AUTO:PUSCh:ACTive OFF ON 0 1 [:SENSe] :EVM:ULINk:PROFile:AUTO:PUSCh:ACTive?
Example	EVM:ULIN:PROF:AUTO:PUSC:ACT OFF EVM:ULIN:PROF:AUTO:PUSC:ACT?
Notes	Changes to this parameter will not be applied until Update Changes command is sent. See “RB Parameter Manager (Uplink)” on page 1118 section for more details.
Dependencies	Enabled when Detection is Auto.
Preset	ON
State Saved	Saved in instrument state.
Initial S/W Revision	A.03.00

DMRS Params

Determines if all DMRS parameters are common to all Slots or if they are to be defined on a per Slot basis when Detection is Manual.

Enabling this parameter causes DMRS Group, DMRS Seq, and DMRS Cyclic Shift to be set automatically using $n_{DMRS}(1)$, $n_{DMRS}(2)$ and ΔSS .

Key Path	Meas Setup, Chan Profile Setup, Edit User Mapping, PUSCH, DMRS Params
Mode	LTE, LTETDD
Remote Command	[:SENSe] :EVM:ULINk:PROFile:USER<n>:PUSCh:DMRS:PARams OFF ON 0 1 [:SENSe] :EVM:ULINk:PROFile:USER<n>:PUSCh:DMRS:PARams?
Example	EVM:ULIN:PROF:USER1:PUSC:DMRS:PAR OFF EVM:ULIN:PROF:USER1:PUSC:DMRS:PAR?
Notes	Changes to this parameter will not be applied until Update Changes command is sent. See “RB Parameter Manager (Uplink)” on page 1118 section for more details.
Dependencies	The range of sub op code <n> values is determined by the number of Users the user has configured. If the user attempts to remotely set or query a sub op code that is out of range, this will result in an error message. When this parameter is on, $n_{DMRS}(1)$, $n_{DMRS}(2)$ and SS are enabled and DMRS Group (u), DMRS Seq (v) and DMRS Cyclic Shift are disabled. When this parameter is off, $n_{DMRS}(1)$, $n_{DMRS}(2)$ and SS are disabled and DMRS Group (u), DMRS Seq (v) and DMRS Cyclic Shift are enabled.

LTE Modulation Analysis Measurement
Meas Setup (Measurement Setup)

Preset	ON
State Saved	Saved in instrument state.
Initial S/W Revision	Prior to A.02.00
Modified at S/W Revision	A.03.00

Auto Detect DMRS Params

Determines if all DMRS parameters to be used are common to all Slots or if they are to be defined on a per Slot basis when Detection is Auto.

Key Path	Meas Setup, Chan Profile Setup, Edit User Mapping, PUSCH, DMRS Params
Mode	LTE, LTETDD
Remote Command	[:SENSe] :EVM:ULINk:PROFile:AUTO:PUSCh:DMRS:PARams OFF ON 0 1 [:SENSe] :EVM:ULINk:PROFile:AUTO:PUSCh:DMRS:PARams?
Example	EVM:ULIN:PROF:AUTO:PUSC:DMRS:PAR OFF EVM:ULIN:PROF:AUTO:PUSC:DMRS:PAR?
Notes	Changes to this parameter will not be applied until Update Changes command is sent. See “RB Parameter Manager (Uplink)” on page 1118 section for more details.
Dependencies	When this parameter is on n DMRS (1), n DMRS (2) and SS are enabled and DMRS Group (u), DMRS Seq (v) and DMRS Cyclic Shift are disabled. When this parameter is off, n DMRS (1), n DMRS (2) and SS are disabled and DMRS Group (u), DMRS Seq (v) and DMRS Cyclic Shift are enabled.
Preset	ON
State Saved	Saved in instrument state.
Initial S/W Revision	Prior to A.02.00
Modified at S/W Revision	A.03.00

n DMRS (1)

Sets the value of $n_{DMRS}(1)$ used by the selected user mapping when Detection is Manual.

Key Path	Meas Setup, Chan Profile Setup, Edit User Mapping, PUSCH, n DMRS (1)
Mode	LTE, LTETDD
Remote Command	[:SENSe] :EVM:ULINk:PROFile:USER<n>:PUSCh:DMRS:ONE <integer> [:SENSe] :EVM:ULINk:PROFile:USER<n>:PUSCh:DMRS:ONE?

Example	EVM:ULIN:PROF:USER1:PUSC:DMRS:ONE 1 EVM:ULIN:PROF:USER1:PUSC:DMRS:ONE?
Notes	Changes to this parameter will not be applied until Update Changes command is sent. See “RB Parameter Manager (Uplink)” on page 1118 section for more details.
Dependencies	The range of sub op code <n> values is determined by the number of Users the user has configured. Max value for n = 50. If the user attempts to remotely set or query a sub op code that is out of range, this will result in an error message. Enabled when Detection is Manual, DMRS Params is On, and PUSCH Active is ON.
Preset	0
State Saved	Saved in instrument state.
Min	0
Max	10
Initial S/W Revision	Prior to A.02.00
Modified at S/W Revision	A.03.00

Auto Detect n DMRS (1)

Sets the value of $n_{DMRS(1)}$ used by the selected user mapping when Detection is Auto.

Key Path	Meas Setup, Chan Profile Setup, Edit User Mapping, PUSCH, n DMRS (1)
Mode	LTE, LTETDD
Remote Command	[:SENSE]:EVM:ULINK:PROF:AUto:PUSCh:DMRS:ONE <integer> [:SENSE]:EVM:ULINK:PROF:AUto:PUSCh:DMRS:ONE?
Example	EVM:ULIN:PROF:AUTO:PUSC:DMRS:ONE 1 EVM:ULIN:PROF:AUTO:PUSC:DMRS:ONE?
Notes	Changes to this parameter will not be applied until Update Changes command is sent. See “RB Parameter Manager (Uplink)” on page 1118 section for more details.
Dependencies	If the user attempts to remotely set or query a sub op code that is out of range, this will result in an error message. Enabled when Detection is Auto, Auto Detect DMRS Params is On, and Auto Detect PUSCH Active is ON.
Preset	0
State Saved	Saved in instrument state.

LTE Modulation Analysis Measurement
Meas Setup (Measurement Setup)

Min	0
Max	10
Initial S/W Revision	Prior to A.02.00
Modified at S/W Revision	A.03.00

n DMRS (2)

Sets the value of $n_{\text{DMRS}(2)}$ used by the selected user mapping when Detection is Manual.

Key Path	Meas Setup, Chan Profile Setup, Edit User Mapping, PUSCH, n DMRS (2)
Mode	LTE, LTETDD
Remote Command	[:SENSe] :EVM:ULINk:PROFile:USER<n>:PUSCh:DMRS:TWO <integer> [:SENSe] :EVM:ULINk:PROFile:USER<n>:PUSCh:DMRS:TWO?
Example	EVM:ULIN:PROF:USER1:PUSC:DMRS:TWO 1 EVM:ULIN:PROF:USER1:PUSC:DMRS:TWO?
Notes	Changes to this parameter will not be applied until Update Changes command is sent. See “RB Parameter Manager (Uplink)” on page 1118 section for more details.
Dependencies	The range of sub op code <n> values is determined by the number of Users the user has configured. Max value for n = 50. If the user attempts to remotely set or query a sub op code that is out of range, this will result in an error message. Enabled when Detection is Manual, DMRS Params is On, and PUSCH Active is ON.
Preset	0
State Saved	Saved in instrument state.
Min	0
Max	10
Initial S/W Revision	Prior to A.02.00
Modified at S/W Revision	A.03.00

Auto Detect n DMRS (2)

Sets the value of $n_{\text{DMRS}(2)}$ used by the selected user mapping when Detection is Auto.

Key Path	Meas Setup, Chan Profile Setup, Edit User Mapping, PUSCH, n DMRS (2)
Mode	LTE, LTETDD

Remote Command	[:SENSE] :EVM:ULINK:PROFile:AUTO:PUSCh:DMRS:TWO <integer> [:SENSE] :EVM:ULINK:PROFile:AUTO:PUSCh:DMRS:TWO?
Example	EVM:ULIN:PROF:AUTO:PUSC:DMRS:TWO 1 EVM:ULIN:PROF:AUTO:PUSC:DMRS:TWO?
Notes	Changes to this parameter will not be applied until Update Changes command is sent. See “RB Parameter Manager (Uplink)” on page 1118 section for more details.
Dependencies	If the user attempts to remotely set or query a sub op code that is out of range, this will result in an error message. Enabled when Detection is Auto and Auto Detect DMRS Params is On, and Auto Detect PUSCH Active is ON.
Preset	0
State Saved	Saved in instrument state.
Min	0
Max	10
Initial S/W Revision	Prior to A.02.00
Modified at S/W Revision	A.03.00

ΔSS (Delta SS)

Sets the value of Delta SS used by the selected user mapping when Detection is Manual.

Key Path	Meas Setup, Chan Profile Setup, Edit User Mapping, PUSCH, ΔSS
Mode	LTE, LTETDD
Remote Command	[:SENSE] :EVM:ULINK:PROFile:USER<n>:PUSCh:DSS <integer> [:SENSE] :EVM:ULINK:PROFile:USER<n>:PUSCh:DSS?
Example	EVM:ULIN:PROF:USER1:PUSC:DSS 1 EVM:ULIN:PROF:USER1:PUSC:DSS?
Notes	Changes to this parameter will not be applied until Update Changes command is sent. See “RB Parameter Manager (Uplink)” on page 1118 section for more details.
Dependencies	The range of sub op code <n> values is determined by the number of Users the user has configured. Max value for n = 50. If the user attempts to remotely set or query a sub op code that is out of range, this will result in an error message. Enabled when Detection is Manual, DMRS Params is On, and PUSCH Active is ON.
Preset	0

LTE Modulation Analysis Measurement
Meas Setup (Measurement Setup)

State Saved	Saved in instrument state.
Min	0
Max	29
Initial S/W Revision	Prior to A.02.00
Modified at S/W Revision	A.03.00

Auto Detect Δ SS (Delta SS)

Sets the value of Delta SS used by the selected user mapping when Detection is Auto.

Key Path	Meas Setup, Chan Profile Setup, Edit User Mapping, PUSCH, ΔSS
Mode	LTE, LTETDD
Remote Command	[:SENSE] :EVM:ULINK:PROF:AUto:PUSCh:DSS <integer> [:SENSE] :EVM:ULINK:PROF:AUto:PUSCh:DSS?
Example	EVM:ULIN:PROF:AUto:PUSCh:DSS 1 EVM:ULIN:PROF:AUto:PUSCh:DSS?
Notes	Changes to this parameter will not be applied until Update Changes command is sent. See “RB Parameter Manager (Uplink)” on page 1118 section for more details.
Dependencies	If the user attempts to remotely set or query a sub op code that is out of range, this will result in an error message. Enabled when Detection is Auto, Auto Detect DMRS Params is On, and Auto Detect PUSCH Active is ON.
Preset	0
State Saved	Saved in instrument state.
Min	0
Max	29
Initial S/W Revision	Prior to A.02.00
Modified at S/W Revision	A.03.00

Frequency Hopping

Selects the frequency hopping type or disables frequency hopping. (3GPP TS 36.211 5.3.4)

The following table shows the combination and its corresponding Freq Hopping selection.

Note that “Type 1, +1/4” and “Type 1, -1/4” are available only when Bandwidth is set to more than or equal to 10MHz.

	Frequency Hopping				
	Off	Type1, +1/4	Type 1, -1/4	Type 1, +1/2	Type 2

Frequency Hopping Mode	Intra- SF	OF F	T1ISF00	T1ISF01	T1ISF10	T2ISF
	Intra/Inter-S F	OF F	T1IISF00	T1IISF01	T1IISF10	T2IISF

Frequency Hopping SCPI Command

Key Path	SCPI Only
Mode	LTE, LTETDD
Remote Command	[:SENSe]:EVM:ULINk:PROFile:USER<n>:PUSCh: FHOPping OFF T1ISF00 T1IISF00 T1ISF01 T1IISF01 T1ISF10 T1IISF10 T2ISF T2IISF [:SENSe]:EVM:ULINk:PROFile:USER<n>:PUSCh:FHOPping?
Example	EVM:ULIN:PROF:USER1:PUSC:FHOP OFF EVM:ULIN:PROF:USER1:PUSC:FHOP?
Notes	Changes to this parameter will not be applied until Update Changes command is sent. See “ RB Parameter Manager (Uplink) ” on page 1118 for more details.
Dependencies	The range of sub op code <n> values is determined by the number of Users the user has configured. If the user attempts to remotely set or query a sub op code that is out of range, this will result in an error message. Available when Detection is Manual.
Preset	OFF
State Saved	Saved in instrument state.
Initial S/W Revision	A.03.00
Modified at S/W Revision	A.06.00

Auto Detect Frequency Hopping SCPI Command

Selects the frequency hopping type or disables frequency hopping when Detection is Auto. (3GPP TS 36.211 5.3.4)

Key Path	SCPI only
Mode	LTE, LTETDD

LTE Modulation Analysis Measurement
Meas Setup (Measurement Setup)

Remote Command	[:SENSe]:EVM:ULINk:PROFile:AUTO:PUSCh:FHOPping OFF T1ISF00 T1IISF00 T1ISF01 T1IISF01 T1ISF10 T1IISF10 T2ISF T2IISF [:SENSe]:EVM:ULINk:PROFile:AUTO:PUSCh:FHOPping?
Example	EVM:ULIN:PROF:AUTO:PUSC:FHOP T2IISF EVM:ULIN:PROF:AUTO:PUSC:FHOP?
Notes	Changes to this parameter will not be applied until Update Changes command is sent. See “RB Parameter Manager (Uplink)” on page 1118 section for more details.
Dependencies	Available when Detection is Auto and Auto Detect PUSCH Active is ON.
Preset	OFF
State Saved	Saved in instrument state.
Range	Off Type1 InterSF00 Type1 IntraInterSF00 Type1InterSF01 Type1IntraInterSF01 Type1 InterSF10 Type1 IntraInterSF10 Type2InterSF Type2 IntraInterSF
Initial S/W Revision	A.03.00
Modified at S/W Revision	A.06.00

Frequency Hopping

Selects frequency hopping or disables frequency hopping. (3GPP TS 36.211 V8.5.0 5.3.4)

Key Path	Meas Setup, Chan Profile Setup, Edit User Mapping
Mode	LTE, LTETDD
Notes	Changes to this parameter will not be applied until Update Changes command is sent. See “RB Parameter Manager (Uplink)” on page 1118 section for more details.
Dependencies	Available when PUSCH Active is ON. “Type 1, +1/4” and “Type 1, -1/4” are enabled only when Bandwidth is set to more than or equal to 10MHz.
Preset	OFF
State Saved	Saved in instrument state.
Range	OFF Type 1, +1/4 Type 1, -1/4 Type 1, +1/2 Type 2
Initial S/W Revision	A.03.00
Modified at S/W Revision	A.06.00

Frequency Hopping Mode

Selects the frequency hopping mode. (3GPP TS 36.211 V8.5.0 5.3.4)

Key Path	Meas Setup, Chan Profile Setup, Edit User Mapping
Mode	LTE, LTETDD
Notes	Changes to this parameter will not be applied until the Update Changes command is sent. See “RB Parameter Manager (Uplink)” on page 1118 section for more details.
Dependencies	Available when PUSCH Active is ON.
Preset	OFF
State Saved	Saved in instrument state.
Range	Inter-SF Intra/Inter-SF
Initial S/W Revision	A.03.00
Modified at S/W Revision	A.06.00

Hopping Offset (NRBHO)

Sets the value of Hopping Offset (N_{RB}^{HO}) when Detection is Manual. Hopping Offset is the offset used for PUSCH frequency hopping, expressed in number of resource blocks. (3GPP TS 36.211 V8.5.0 5.3.4).

Key Path	Meas Setup, Chan Profile Setup, Edit User Mapping, PUSCH
Mode	LTE, LTETDD
Remote Command	[:SENSe] :EVM:ULINk:PROfile:USER<n>:PUSCh:NRBHo:<integer> [:SENSe] :EVM:ULINk:PROfile:USER<n>:PUSCh:NRBHo?
Example	EVM:ULIN:PROF:USER1:PUSC:NRBH 1 EVM:ULIN:PROF:USER1:PUSC:NRBH?
Notes	Changes to this parameter will not be applied until Update Changes command is sent. See “RB Parameter Manager (Uplink)” on page 1118 section for more details.
Dependencies	The range of sub op code <n> values is determined by the number of Users the user has configured. If the user attempts to remotely set or query a sub op code that is out of range, this will result in an error message. Enabled when Detection is Manual, Frequency Hopping is not OFF, and PUSCH Active is ON.
Couplings	Hopping Offset should always be less than or equal to the total RB number of the selected Bandwidth.
Preset	0

LTE Modulation Analysis Measurement
Meas Setup (Measurement Setup)

State Saved	Saved in instrument state.
Min	0
Max	6 - Bandwidth 1.4 MHz 15 - Bandwidth 3 MHz 25 - Bandwidth 5 MHz 50 - Bandwidth 10 MHz 75 - Bandwidth 15 MHz 100 - Bandwidth 20 MHz
Initial S/W Revision	A.03.00
Modified at S/W Revision	A.06.00

Auto Detect Hopping Offset (NRBHO)

Sets the value of Hopping Offset (N_{RB}^{HO}) when Detection is Auto. Hopping Offset is the offset used for PUSCH frequency hopping, expressed in number of resource blocks. (3GPP TS 36.211 V8.5.0 5.3.4).

Key Path	Meas Setup, Chan Profile Setup, Edit User Mapping, PUSCH
Mode	LTE, LTETDD
Remote Command	[:SENSE] :EVM:ULINK:PROF:AUto:PUSCh:NRBH<integer> [:SENSE] :EVM:ULINK:PROF:AUto:PUSCh:NRBH?
Example	EVM:ULIN:PROF:AUTO:PUSC:NRBH 1 EVM:ULIN:PROF:AUTO:PUSC:NRBH?
Notes	Changes to this parameter will not be applied until Update Changes command is sent. See “RB Parameter Manager (Uplink)” on page 1118 section for more details.
Dependencies	Enabled when Detection is Auto, Auto Detect Frequency Hopping is not OFF, and Auto Detect PUSCH Active is ON.
Couplings	Hopping Offset should always be less than or equal to the total RB number of the selected Bandwidth.
Preset	0
State Saved	Saved in instrument state.
Min	0

Max	6 - Bandwidth 1.4 MHz 15 - Bandwidth 3 MHz 25 - Bandwidth 5 MHz 50 - Bandwidth 10 MHz 75 - Bandwidth 15 MHz 100 - Bandwidth 20 MHz
Initial S/W Revision	A.03.00
Modified at S/W Revision	A.06.00

Number of sub-bands (Nsb)

Sets the number of sub-bands (N_{sb}) when Detection is Manual. (3GPP TS 36.211 V8.5.0 5.3.4).

Key Path	Meas Setup, Chan Profile Setup, Edit User Mapping, PUSCH
Mode	LTE, LTETDD
Remote Command	[:SENSe] :EVM:ULINk:PROFile:USER<n>:PUSCh:NSB <integer> [:SENSe] :EVM:ULINk:PROFile:USER<n>:PUSCh:NSB?
Example	EVM:ULIN:PROF:USER1:PUSC:NSB 1 EVM:ULIN:PROF:USER1:PUSC:NSB?
Notes	Changes to this parameter will not be applied until Update Changes command is sent. See “RB Parameter Manager (Uplink)” on page 1118 section for more details.
Dependencies	The range of sub op code <n> values is determined by the number of Users the user has configured. If the user attempts to remotely set or query a sub op code that is out of range, this will result in an error message. Enabled when Detection is Manual, Frequency Hopping is set to either Type2InterSF or Type2InterIntraSF, and PUSCH Active is ON.
Couplings	Nsb should always be less than or equal to the total RB number of the selected Bandwidth.
Preset	1
State Saved	Saved in instrument state.
Min	1
Max	4
Initial S/W Revision	A.03.00
Modified at S/W Revision	A.06.00, A.10.00

Auto Detect Number of Sub-bands (Nsb)

Sets the Number of Sub-bands (N_{sb}) when Detection is Auto. (3GPP TS 36.211 V8.5.0 5.3.4).

Key Path	Meas Setup, Chan Profile Setup, Edit User Mapping, PUSCH
Mode	LTE, LTETDD
Remote Command	[:SENSe] :EVM:ULINk:PROFile:AUTO:PUSCh:NSB <integer> [:SENSe] :EVM:ULINk:PROFile:AUTO:PUSCh:NSB?
Example	EVM:ULIN:PROF:AUTO:PUSC:NSB 1 EVM:ULIN:PROF:AUTO:PUSC:NSB?
Notes	Changes to this parameter will not be applied until Update Changes command is sent. See “ RB Parameter Manager (Uplink) ” on page 1118 section for more details.
Dependencies	Enabled when Detection is Auto, Auto Detect Frequency Hopping is set to either Type2InterSF or Type2InterIntraSF, and Auto Detect PUSCH Active is ON.
Couplings	Nsb should always be less than or equal to the total RB number of the selected Bandwidth.
Preset	1
State Saved	Saved in instrument state.
Min	1
Max	4
Initial S/W Revision	A.03.00
Modified at S/W Revision	A.06.00, A.10.00

PUSCH Sync Slot

Sets the Sync Slot for all PUSCH Slots when Detection is Manual.

Sync Slot specifies the index of the slot to use for initial synchronization when PUSCH is selected as the Sync Type. The demodulator searches for the slot with the characteristics specified in Per-slot Parameters and the slot that matches the Per-slot Parameters with the highest correlation will be assigned the slot number given in the Sync Slot parameter.

When Sync Slot is set to Auto, the demod algorithm may automatically determine the best time slot to synchronize to. This approach simplifies parameter entry and provides easier setup. However, the complexity of the algorithm makes it rather slow and prone to errors in the presence of noise.

Key Path	Meas Setup, Chan Profile Setup, Edit User Mapping
Mode	LTE, LTETDD

Remote Command	<pre>[:SENSe]:EVM:ULINk:PROFile:USER<n>:PUSCh:SSLot:<integer> [:SENSe]:EVM:ULINk:PROFile:USER<n>:PUSCh:SSLot? [:SENSe]:EVM:ULINk:PROFile:USER<n>:PUSCh:SSLot:AUTO OFF ON 0 1 [:SENSe]:EVM:ULINk:PROFile:USER<n>:PUSCh:SSLot:AUTO?</pre>
Example	<pre>EVM:ULIN:PROF:USER1:PUSC:SSL 1 EVM:ULIN:PROF:USER1:PUSC:SSL? EVM:ULIN:PROF:USER1:PUSC:SSL:AUTO 1 EVM:ULIN:PROF:USER1:PUSC:SSL:AUTO?</pre>
Notes	Changes to this parameter will not be applied until Update Changes command is sent. See “RB Parameter Manager (Uplink)” on page 1118 section for more details.
Dependencies	<p>The range of sub op code <n> values is determined by the number of Users the user has configured. Max value for n=50.</p> <p>If the user attempts to remotely set or query a sub op code that is out of range, this will result in an error message.</p> <p>PUSCH Sync Slot is enabled when PUSCH Active is ON, Detection is Manual and PUSCH Sync Slot Auto is OFF.</p> <p>PUSCH Sync Slot Auto is enabled when PUSCH Active is ON and Detection is Manual</p>
Preset	0 ON
State Saved	Saved in instrument state.
Min	0
Max	19
Initial S/W Revision	Prior to A.02.00
Modified at S/W Revision	A.03.00

Auto Detect PUSCH Sync Slot

Sets the Sync Slot for all PUSCH Slots when Detection is Auto.

Key Path	Meas Setup, Chan Profile Setup, Edit User Mapping
Mode	LTE, LTETDD

LTE Modulation Analysis Measurement
Meas Setup (Measurement Setup)

Remote Command	<pre>[:SENSe]:EVM:ULINk:PROFile:AUTO:PUSCh:SSLot <integer> [:SENSe]:EVM:ULINk:PROFile:AUTO:PUSCh:SSLot? [:SENSe]:EVM:ULINk:PROFile:AUTO:PUSCh:SSLot:AUTO OFF ON 0 1 [:SENSe]:EVM:ULINk:PROFile:AUTO:PUSCh:SSLot:AUTO?</pre>
Example	<pre>EVM:ULIN:PROF:AUTO:PUSC:SSL 1 EVM:ULIN:PROF:AUTO:PUSC:SSL? EVM:ULIN:PROF:AUTO:PUSC:SSL:AUTO 1 EVM:ULIN:PROF:AUTO:PUSC:SSL:AUTO?</pre>
Notes	Changes to this parameter will not be applied until Update Changes command is sent. See “RB Parameter Manager (Uplink)” on page 1118 section for more details.
Dependencies	<p>Auto Detect PUSCH Sync Slot is enabled when Auto Detect PUSCH Active is ON, Detection is Auto and Auto Detect PUSCH Sync Slot Auto is OFF.</p> <p>Auto Detect PUSCH Sync Slot Auto is enabled when Auto Detect PUSCH Active is ON and Detection is Auto.</p>
Preset	0 ON
State Saved	Saved in instrument state.
Min	0
Max	19
Initial S/W Revision	Prior to A.02.00
Modified at S/W Revision	A.03.00

PUSCH Couple

Selecting the checkbox next to a parameter in the PUSCH Per-slot Parameters area will couple that parameter across all RB allocation.

Key Path	Meas Setup, Chan Profile Setup, Edit User Mapping
----------	--

Common RB Start

Specifies the RB start boundary when Couple is On.

Key Path	Meas Setup, Chan Profile Setup, Edit User Mapping, PUSCH
----------	---

RB Start

Sets the Start Resource Block for all the PUSCH Slots when RB Start Couple is On and when Detection is Manual.

Key Path	Meas Setup, Chan Profile Setup, Edit User Mapping, PUSCH, RB Start
----------	---

Mode	LTE, LTETDD
Remote Command	[:SENSe] :EVM:ULINk:PROFile:USER<n>:PUSCh:RB:STARt <integer> [:SENSe] :EVM:ULINk:PROFile:USER<n>:PUSCh:RB:STARt?
Example	EVM:ULIN:PROF:USER1:PUSC:RB:STAR 0 EVM:ULIN:PROF:USER1:PUSC:RB:STAR?
Notes	Changes to this parameter will not be applied until Update Changes command is sent. See “RB Parameter Manager (Uplink)” on page 1118 section for more details.
Dependencies	The range of sub op code <n> values is determined by the number of Users the user has configured. Max value for n = 50. If the user attempts to remotely set or query a sub op code that is out of range, this will result in an error message. Enabled when Detection is Manual, RB Start Couple is ON, and PUSCH Active is ON.
Couplings	If the user attempts to set a RB Start value greater than the RB Stop value, both values will be set to the RB Start value or clipped to the min or max value if the entered value is out of range
Preset	0
State Saved	Saved in instrument state.
Min	0
Max	5 – Bandwidth 1.4 MHz 14 – Bandwidth 3 MHz 24 – Bandwidth 5 MHz 49 – Bandwidth 10 MHz 74 – Bandwidth 15 MHz 99 – Bandwidth 20 MHz
Initial S/W Revision	Prior to A.02.00
Modified at S/W Revision	A.03.00

Auto Detect RB Start

Sets the Start Resource Block for all the PUSCH Slots when Detection is Auto.

Key Path	Meas Setup, Chan Profile Setup, Edit User Mapping, PUSCH, RB Start
Mode	LTE, LTETDD

LTE Modulation Analysis Measurement
Meas Setup (Measurement Setup)

Remote Command	[:SENSe]:EVM:ULINk:PROFile:AUTO:PUSCh:RB:STARt <integer> [:SENSe]:EVM:ULINk:PROFile:AUTO:PUSCh:RB:STARt?
Example	EVM:ULIN:PROF:AUTO:PUSC:RB:STAR 0 EVM:ULIN:PROF:AUTO:PUSC:RB:STAR?
Notes	Changes to this parameter will not be applied until Update Changes command is sent. See “ RB Parameter Manager (Uplink) ” on page 1118 section for more details.
Dependencies	Enabled when Detection is Auto and Auto Detect PUSCH Auto Sync Slot is OFF, and Auto Detect PUSCH Active is ON.
Couplings	If the user attempts to set a RB Start value greater than the RB Stop value, both values will be set to the RB Start value or clipped to the min or max value if the entered value is out of range
Preset	0
State Saved	Saved in instrument state.
Min	0
Max	5 – Bandwidth 1.4 MHz 14 – Bandwidth 3 MHz 24 – Bandwidth 5 MHz 49 – Bandwidth 10 MHz 74 – Bandwidth 15 MHz 99 – Bandwidth 20 MHz
Initial S/W Revision	Prior to A.02.00
Modified at S/W Revision	A.03.00

RB Start Couple

Determines whether or not all the PUSCH Slots will use the Common RB Start value.

Key Path	Meas Setup, Chan Profile Setup, Edit User Mapping, PUSCH, Couple Power Boost
Mode	LTE, LTETDD
Remote Command	[:SENSe]:EVM:ULINk:PROFile:USER<n>:PUSCh:RB:STARt:COUPl e OFF ON 0 1 [:SENSe]:EVM:ULINk:PROFile:USER<n>:PUSCh:RB:STARt:COUPl e?
Example	EVM:ULIN:PROF:USER1:PUSC:RB:STAR:COUP ON EVM:ULIN:PROF:USER1:PUSC:RB:STAR:COUP?

Notes	Changes to this parameter will not be applied until Update Changes command is sent. See “ RB Parameter Manager (Uplink) ” on page 1118 section for more details.
Dependencies	The range of sub op code <n> values is determined by the number of Users the user has configured. Max value for n = 50. If the user attempts to remotely set or query a sub op code that is out of range, this will result in an error message. Enabled when Detection is Manual, and PUSCH Active is ON.
Preset	ON
State Saved	Saved in instrument state.
Initial S/W Revision	Prior to A.02.00
Modified at S/W Revision	A.03.00

Common RB End

Specifies the RB end boundary.

Key Path	Meas Setup, Chan Profile Setup, Edit User Mapping, PUSCH
----------	---

RB End

Sets the End Resource Block for all the PUSCH Slots when RB End Couple is On and when Detection is Manual.

Key Path	Meas Setup, Chan Profile Setup, Edit User Mapping, PUSCH, RB End
Mode	LTE, LTETDD
Remote Command	[:SENSE] :EVM:ULINK:PROF:USER<n>:PUSCh:RB:END <integer> [:SENSE] :EVM:ULINK:PROF:USER<n>:PUSCh:RB:END?
Example	EVM:ULIN:PROF:USER1:PUSC:RB:END 0 EVM:ULIN:PROF:USER1:PUSC:RB:END?
Notes	Changes to this parameter will not be applied until Update Changes command is sent. See “ RB Parameter Manager (Uplink) ” on page 1118 section for more details.
Dependencies	The range of sub op code <n> values is determined by the number of Users the user has configured. Max value for n = 50. If the user attempts to remotely set or query a sub op code that is out of range, this will result in an error message. Enabled when Detection is Manual, RB End Couple is ON, and PUSCH Active is ON.
Couplings	If the user attempts to set a RB End value less than the RB Start value, both values will be set to the RB End value or clipped to the min or max value if the entered value is out of range

LTE Modulation Analysis Measurement
Meas Setup (Measurement Setup)

Preset	0
State Saved	Saved in instrument state.
Min	0
Max	5 – Bandwidth 1.4 MHz 14 – Bandwidth 3 MHz 24 – Bandwidth 5 MHz 49 – Bandwidth 10 MHz 74 – Bandwidth 15 MHz 99 – Bandwidth 20 MHz
Initial S/W Revision	Prior to A.02.00
Modified at S/W Revision	A.03.00

Auto Detect RB End

Sets the End Resource Block for all the PUSCH Slots when Detection is Auto.

Key Path	Meas Setup, Chan Profile Setup, Edit User Mapping, PUSCH, RB End
Mode	LTE, LTETDD
Remote Command	[:SENSE] :EVM:ULINK:PROFile:AUTO:PUSCh:RB:END <integer> [:SENSE] :EVM:ULINK:PROFile:AUTO:PUSCh:RB:END?
Example	EVM:ULIN:PROF:AUTO:PUSC:RB:END 0 EVM:ULIN:PROF:AUTO:PUSC:RB:END?
Notes	Changes to this parameter will not be applied until Update Changes command is sent. See “RB Parameter Manager (Uplink)” on page 1118 section for more details.
Dependencies	Enabled when Detection is Auto, Auto Detect PUSCH Auto Sync Slot is OFF, and Auto Detect PUSCH Active is ON.
Couplings	If the user attempts to set a RB End value less than the RB Start value, both values will be set to the RB End value or clipped to the min or max value if the entered value is out of range
Preset	0
State Saved	Saved in instrument state.
Min	0

Max	5 – Bandwidth 1.4 MHz 14 – Bandwidth 3 MHz 24 – Bandwidth 5 MHz 49 – Bandwidth 10 MHz 74 – Bandwidth 15 MHz 99 – Bandwidth 20 MHz
Initial S/W Revision	Prior to A.02.00
Modified at S/W Revision	A.03.00

RB End Couple

Determines whether or not all the PUSCH Slots will use the Common RB Start value.

Key Path	Meas Setup, Chan Profile Setup, Edit User Mapping, PUSCH, Couple Power Boost
Mode	LTE, LTETDD
Remote Command	[:SENSE] :EVM:ULINK:PROF:USER<n>:PUSCh:RB:END:COUple OFF ON 0 1 [:SENSE] :EVM:ULINK:PROF:USER<n>:PUSCh:RB:END:COUple?
Example	EVM:ULIN:PROF:USER1:PUSC:RB:END:COUP ON EVM:ULIN:PROF:USER1:PUSC:RB:END:COUP?
Notes	Changes to this parameter will not be applied until Update Changes command is sent. See “ RB Parameter Manager (Uplink) ” on page 1118 section for more details.
Dependencies	The range of sub op code <n> values is determined by the number of Users the user has configured. Max value for n = 50. If the user attempts to remotely set or query a sub op code that is out of range, this will result in an error message. Enabled when Detection is Manual, and PUSCH Active is ON.
Preset	ON
State Saved	Saved in instrument state.
Initial S/W Revision	Prior to A.02.00
Modified at S/W Revision	A.03.00

Common Mod Type

Selects the Modulation Type for all the PUSCH Slots when Mod Type Couple is On and Detection is Manual.

Key Path	Meas Setup, Chan Profile Setup, Edit User Mapping, PUSCH, Mod Type
Mode	LTE, LTETDD

LTE Modulation Analysis Measurement
Meas Setup (Measurement Setup)

Remote Command	[:SENSE]:EVM:ULINK:PROFile:USER<n>:PUSCh:MODulation:TYPE QPSK QAM16 QAM64 [:SENSE]:EVM:ULINK:PROFile:USER<n>:PUSCh:MODulation:TYPE?
Example	EVM:ULIN:PROF:USER1:PUSC:MOD:TYPE QPSK EVM:ULIN:PROF:USER1:PUSC:MOD:TYPE?
Notes	Changes to this parameter will not be applied until Update Changes command is sent. See “RB Parameter Manager (Uplink)” on page 1118 section for more details.
Dependencies	The range of sub op code <n> values is determined by the number of Users the user has configured. Max value for n=50. If the user attempts to remotely set or query a sub op code that is out of range, this will result in an error message. Enabled when Mod Type Couple is On, Detection is Manual, and PUSCH Active is ON.
Preset	QPSK
State Saved	Saved in instrument state.
Range	QPSK QAM16 QAM64
Initial S/W Revision	Prior to A.02.00
Modified at S/W Revision	A.03.00

Auto Detect Mod Type

Selects the Modulation Type for all the PUSCH Slots when Detection is Auto.

Key Path	Meas Setup, Chan Profile Setup, Edit User Mapping, PUSCH, Mod Type
Mode	LTE, LTETDD
Remote Command	[:SENSE]:EVM:ULINK:PROFile:AUTO:PUSCh:MODulation:TYPE QPSK QAM16 QAM64 [:SENSE]:EVM:ULINK:PROFile:AUTO:PUSCh:MODulation:TYPE?
Example	EVM:ULIN:PROF:AUTO:PUSC:MOD:TYPE QPSK EVM:ULIN:PROF:AUTO:PUSC:MOD:TYPE?
Notes	Changes to this parameter will not be applied until Update Changes command is sent. See “RB Parameter Manager (Uplink)” on page 1118 section for more details.
Dependencies	Always grayed out.
Preset	QPSK
State Saved	Saved in instrument state.

Range	QPSK QAM16 QAM64
Initial S/W Revision	Prior to A.02.00
Modified at S/W Revision	A.03.00

QPSK

Selects QPSK for the Modulation Type for all the PUSCH Slots when Mod Type Couple is On.

Key Path	Meas Setup, Chan Profile Setup, Edit User Mapping, PUSCH, Mod Type
Mode	LTE, LTETDD
Initial S/W Revision	Prior to A.02.00
Modified at S/W Revision	A.03.00

16QAM

Selects 16QAM for the Modulation Type for all the PUSCH Slots when Mod Type Couple is On.

Key Path	Meas Setup, Chan Profile Setup, Edit User Mapping, PUSCH, Couple Mod Type
Mode	LTE, LTETDD
Initial S/W Revision	Prior to A.02.00
Modified at S/W Revision	A.03.00

64QAM

Selects 64QAM for the Modulation Type for all the PUSCH Slots when Mod Type Couple is On.

Key Path	Meas Setup, Chan Profile Setup, Edit User Mapping, PUSCH, Couple Mod Type
Mode	LTE, LTETDD
Initial S/W Revision	Prior to A.02.00
Modified at S/W Revision	A.03.00

Mod Type Couple

Determines whether or not all the PUSCH Slots will use the Common Mod Type value.

Key Path	Meas Setup, Chan Profile Setup, Edit User Mapping, PUSCH, Couple Mod Type
Mode	LTE, LTETDD

LTE Modulation Analysis Measurement
Meas Setup (Measurement Setup)

Remote Command	[:SENSe]:EVM:ULINK:PROFile:USER<n>:PUSCh:MODulation:TYPE:COUPle OFF ON 0 1 [:SENSe]:EVM:ULINK:PROFile:USER<n>:PUSCh:MODulation:TYPE:COUPle?
Example	EVM:ULIN:PROF:USER1:PUSC:MOD:TYPE:COUP ON EVM:ULIN:PROF:USER1:PUSC:MOD:TYPE:COUP?
Notes	Changes to this parameter will not be applied until Update Changes command is sent. See “RB Parameter Manager (Uplink)” on page 1118 section for more details.
Dependencies	The range of sub op code <n> values is determined by the number of Users the user has configured. Max value for n = 50. If the user attempts to remotely set or query a sub op code that is out of range, this will result in an error message. Enabled when Detection is Manual and PUSCH Active is ON.
Preset	ON
State Saved	Saved in instrument state.
Initial S/W Revision	Prior to A.02.00
Modified at S/W Revision	A.03.00

Common Power Boost

Sets the PUSCH average power level relative to the 0 dB set by the PUSCH DMRS Power.

Key Path	Meas Setup, Chan Profile Setup, Edit User Mapping, PUSCH
----------	---

Power Boost

Sets the Power Boost value for all the PUSCH Slots when Power Boost Couple is On and Detection is Manual.

Power Boost sets the PUSCH average power level relative to the 0 dB point set by the PUSCH DMRS Power.

Key Path	Meas Setup, Chan Profile Setup, Edit User Mapping, PUSCH, Couple Power
Mode	LTE, LTETDD
Remote Command	[:SENSe]:EVM:ULINK:PROFile:USER<n>:PUSCh:PWRBoost <rel_ampl> [:SENSe]:EVM:ULINK:PROFile:USER<n>:PUSCh:PWRBoost?
Example	EVM:ULIN:PROF:USER1:PUSC:PWRB 0 EVM:ULIN:PROF:USER1:PUSC:PWRB?
Notes	Changes to this parameter will not be applied until Update Changes command is sent. See “RB Parameter Manager (Uplink)” on page 1118 section for more details.

Dependencies	The range of sub op code <n> values is determined by the number of Users the user has configured. Max value for n = 50. If the user attempts to remotely set or query a sub op code that is out of range, this will result in an error message. Enabled when Detection is Manual, Power Boost Couple is On, and PUSCH Active is ON.
Preset	0 dB
State Saved	Saved in instrument state.
Min	-100 dB
Max	100 dB
Initial S/W Revision	Prior to A.02.00
Modified at S/W Revision	A.03.00, A.04.20

Auto Detect Power Boost

Sets the Power Boost value for all the PUSCH Slots when Detection is Auto.

Key Path	Meas Setup, Chan Profile Setup, Edit User Mapping, PUSCH,Couple Power
Mode	LTE, LTETDD
Remote Command	[:SENSE]:EVM:ULINK:PROFile:AUTO:PUSCh:PWRBoost <rel_ampl> [:SENSE]:EVM:ULINK:PROFile:AUTO:PUSCh:PWRBoost?
Example	EVM:ULIN:PROF:AUTO:PUSC:PWRB 0 EVM:ULIN:PROF:AUTO:PUSC:PWRB?
Notes	Changes to this parameter will not be applied until Update Changes command is sent. See “RB Parameter Manager (Uplink)” on page 1118 section for more details.
Dependencies	Enabled when Detection is Auto and Auto Detect PUSCH Active is ON.
Preset	0 dB
State Saved	Saved in instrument state.
Min	-100 dB
Max	100 dB
Initial S/W Revision	Prior to A.02.00
Modified at S/W Revision	A.03.00, A.04.20

LTE Modulation Analysis Measurement
Meas Setup (Measurement Setup)

Power Boost Couple

Determines whether or not all the PUSCH Slots will use the Common Power Boost value.

Key Path	Meas Setup, Chan Profile Setup, Edit User Mapping, PUSCH, Couple Power
Mode	LTE, LTETDD
Remote Command	[:SENSe] :EVM:ULINk:PROFile:USER<n>:PUSCh:PWRBoost:COUPl e OFF ON 0 1 [:SENSe] :EVM:ULINk:PROFile:USER<n>:PUSCh:PWRBoost:COUPl e
Example	EVM:ULIN:PROF:USER1:PUSC:PWRB:COUP ON EVM:ULIN:PROF:USER1:PUSC:PWRB:COUP?
Notes	Changes to this parameter will not be applied until Update Changes command is sent. See “RB Parameter Manager (Uplink)” on page 1118 section for more details.
Dependencies	The range of sub op code <n> values is determined by the number of Users the user has configured. Max value for n = 50. If the user attempts to remotely set or query a sub op code that is out of range, this will result in an error message. Enabled when Detection is Manual.
Preset	ON
State Saved	Saved in instrument state.
Initial S/W Revision	Prior to A.02.00
Modified at S/W Revision	A.03.00

Common DMRS Group

Specifies the DMRS Group for a slot.

Key Path	Meas Setup, Chan Profile Setup, Edit User Mapping, PUSCH
----------	---

DMRS Group

Sets the DMRS Group for all the PUSCH Slots when DMRS Group Couple is On and when Detection is Manual.

Key Path	Meas Setup, Chan Profile Setup, Edit User Mapping, PUSCH, DMRS Group
Mode	LTE, LTETDD
Remote Command	[:SENSe] :EVM:ULINk:PROFile:USER<n>:PUSCh:DMRS:GROUp <integer> [:SENSe] :EVM:ULINk:PROFile:USER<n>:PUSCh:DMRS:GROUp?

Example	EVM:ULIN:PROF:USER1:PUSC:DMRS:GRO 1 EVM:ULIN:PROF:USER1:PUSC:DMRS:GRO?
Notes	Changes to this parameter will not be applied until Update Changes command is sent. See “RB Parameter Manager (Uplink)” on page 1118 section for more details.
Dependencies	The range of sub op code <n> values is determined by the number of Users the user has configured. Max value for n = 50.If the user attempts to remotely set or query a sub op code that is out of range, this will result in an error message. Enabled when Detection is Manual, DMRS Params is Off, DMRS Group Couple is On, and PUSCH Active is ON.
Preset	0
State Saved	Saved in instrument state.
Min	0
Max	29
Initial S/W Revision	Prior to A.02.00
Modified at S/W Revision	A.03.00

Auto Detect DMRS Group

Sets the DMRS Group for all the PUSCH Slots when Detection is Auto.

Key Path	Meas Setup, Chan Profile Setup, Edit User Mapping, PUSCH, DMRS Group
Mode	LTE, LTETDD
Remote Command	[:SENSE]:EVM:ULINK:PROfile:AUTO:PUSCh:DMRS:GROup <integer> [:SENSE]:EVM:ULINK:PROfile:AUTO:PUSCh:DMRS:GROup?
Example	EVM:ULIN:PROF:AUTO:PUSC:DMRS:GRO 1 EVM:ULIN:PROF:AUTO:PUSC:DMRS:GRO?
Notes	Changes to this parameter will not be applied until Update Changes command is sent. See “RB Parameter Manager (Uplink)” on page 1118 section for more details.
Dependencies	Enabled when Detection is Auto, Auto Detect DMRS Params is Off, and Auto Detect PUSCH Active is ON.
Preset	0
State Saved	Saved in instrument state.
Min	0
Max	29

LTE Modulation Analysis Measurement
Meas Setup (Measurement Setup)

Initial S/W Revision	Prior to A.02.00
Modified at S/W Revision	A.03.00

DMRS Group Couple

Determines whether or not all the PUSCH Slots will use the Common DMRS Group value.

Key Path	Meas Setup, Chan Profile Setup, Edit User Mapping, PUSCH,DMRS Group
Mode	LTE, LTETDD
Remote Command	[:SENSe] :EVM:ULINk:PROFile:USER<n>:PUSCh:DMRS:GROup:COU Ple OFF ON 0 1 [:SENSe] :EVM:ULINk:PROFile:USER<n>:PUSCh:DMRS:GROup:COU Ple?
Example	EVM:ULIN:PROF:USER1:PUSC:DMRS:GRO:COUP ON EVM:ULIN:PROF:USER1:PUSC:DMRS:GRO:COUP?
Notes	Changes to this parameter will not be applied until Update Changes command is sent. See “ RB Parameter Manager (Uplink) ” on page 1118 section for more details.
Dependencies	The range of sub op code <n> values is determined by the number of Users the user has configured. Max value for n = 50. If the user attempts to remotely set or query a sub op code that is out of range, this will result in an error message. Enabled when Detection is Manual, DMRS Params is Off, PUSCH Active is ON, and PUSCH Active is ON.
Preset	ON
State Saved	Saved in instrument state.
Initial S/W Revision	Prior to A.02.00
Modified at S/W Revision	A.03.00

Common DMRS Sequence

Specifies the RMRS Sequence for a slot.

Key Path	Meas Setup, Chan Profile Setup, Edit User Mapping, PUSCH
----------	---

DMRS Sequence

Sets the DMRS Sequence (v) for all the PUSCH Slots when DMRS Sequence Couple is On and when Detection is Manual. DMRS Sequence or v, is the sequence number within the group and can take on values from 0 to $\text{floor}(N_{ZC}^{RS}/30)-1$, where N_{ZC}^{RS} is the largest prime number less than M_{SC}^{RS}

Key Path	Meas Setup, Chan Profile Setup, Edit User Mapping, PUSCH, DMRS Seq
Mode	LTE, LTETDD

Remote Command	[:SENSE] :EVM:ULINK:PROFile:USER<n>:PUSCh:DMRS:SEQuence <integer> [:SENSE] :EVM:ULINK:PROFile:USER<n>:PUSCh:DMRS:SEQuence?
Example	EVM:ULIN:PROF:USER1:PUSC:DMRS:SEQ 1 EVM:ULIN:PROF:USER1:PUSC:DMRS:SEQ?
Notes	Changes to this parameter will not be applied until Update Changes command is sent. See “RB Parameter Manager (Uplink)” on page 1118 section for more details.
Dependencies	The range of sub op code <n> values is determined by the number of Users the user has configured. Max value for n = 50. If the user attempts to remotely set or query a sub op code that is out of range, this will result in an error message. Enabled when Detection is Manual, DMRS Params is Off, DMRS Sequence Couple is On, and PUSCH Active is ON.
Preset	0
State Saved	Saved in instrument state.
Min	0
Max	1
Initial S/W Revision	Prior to A.02.00
Modified at S/W Revision	A.03.00

Auto Detect DMRS Sequence

Sets the DMRS Sequence (v) for all the PUSCH Slots when Detection is Auto. DMRS Sequence or v, is the sequence number within the group and can take on values from 0 to $\text{floor}(N_{ZC}^{RS}/30)-1$, where N_{ZC}^{RS} is the largest prime number less than M_{SC}^{RS}

Key Path	Meas Setup, Chan Profile Setup, Edit User Mapping, PUSCH,DMRS Seq
Mode	LTE, LTETDD
Remote Command	[:SENSE] :EVM:ULINK:PROFile:AUTO:PUSCh:DMRS:SEQuence <integer> [:SENSE] :EVM:ULINK:PROFile:AUTO:PUSCh:DMRS:SEQuence?
Example	EVM:ULIN:PROF:AUTO:PUSC:DMRS:SEQ 1 EVM:ULIN:PROF:AUTO:PUSC:DMRS:SEQ?
Notes	Changes to this parameter will not be applied until Update Changes command is sent. See “RB Parameter Manager (Uplink)” on page 1118 section for more details.
Dependencies	Enabled when Detection is Auto, Auto Detect DMRS Params is Off, and Auto Detect PUSCH Active is ON.

LTE Modulation Analysis Measurement
Meas Setup (Measurement Setup)

Preset	0
State Saved	Saved in instrument state.
Min	0
Max	$\text{floor}(N_{ZC}^{RS}/30)-1$ (can be restricted based on bandwidth)
Initial S/W Revision	Prior to A.02.00
Modified at S/W Revision	A.03.00

DMRS Sequence Couple

Determines whether or not all the PUSCH Slots will use the Common DMRS Sequence value.

Key Path	Meas Setup, Chan Profile Setup, Edit User Mapping, PUSCH, DMRS Seq
Mode	LTE, LTETDD
Remote Command	[:SENSe] :EVM:ULINk:PROFile:USER<n>:PUSCh:DMRS:SEQuence:COUPle OFF ON 0 1 [:SENSe] :EVM:ULINk:PROFile:USER<n>:PUSCh:DMRS:SEQuence:COUPle?
Example	EVM:ULIN:PROF:USER1:PUSC:DMRS:SEQ:COUP ON EVM:ULIN:PROF:USER1:PUSC:DMRS:SEQ:COUP?
Notes	Changes to this parameter will not be applied until Update Changes command is sent. See “RB Parameter Manager (Uplink)” on page 1118 section for more details.
Dependencies	The range of sub op code <n> values is determined by the number of Users the user has configured. Max value for n = 50.If the user attempts to remotely set or query a sub op code that is out of range, this will result in an error message. Enabled when Detection is Manual, DMRS Params is OFF, and PUSCH Active is ON.
Preset	ON
State Saved	Saved in instrument state.
Initial S/W Revision	Prior to A.02.00
Modified at S/W Revision	A.03.00

Common DMRS Cyclic Shift

Specifies the DMRS Cyclic Shift for a slot.

Key Path	Meas Setup, Chan Profile Setup, Edit User Mapping, PUSCH
----------	---

DMRS Cyclic Shift

Sets the DMRS Cyclic Shift for all the PUSCH Slots when DMRS Cyclic Shift Couple is On and Detection is Manual.

Key Path	Meas Setup, Chan Profile Setup, Edit User Mapping, PUSCH, DMRS Cyclic Shift Couple
Mode	LTE, LTETDD
Remote Command	[:SENSe] :EVM:ULINk:PROFile:USER<n>:PUSCh:DMRS:CSHift <integer> [:SENSe] :EVM:ULINk:PROFile:USER<n>:PUSCh:DMRS:CSHift?
Example	EVM:ULIN:PROF:USER1:PUSC:DMRS:CSH 1 EVM:ULIN:PROF:USER1:PUSC:DMRS:CSH?
Notes	Changes to this parameter will not be applied until Update Changes command is sent. See “RB Parameter Manager (Uplink)” on page 1118 section for more details.
Dependencies	The range of sub op code <n> values is determined by the number of Users the user has configured. Max value for n = 50. If the user attempts to remotely set or query a sub op code that is out of range, this will result in an error message. Enabled when Detection is Manual, DMRS Params is Off, and DMRS Cyclic Shift Couple is On
Preset	0
State Saved	Saved in instrument state.
Min	0
Max	11
Initial S/W Revision	Prior to A.02.00
Modified at S/W Revision	A.03.00

Auto Detect DMRS Cyclic Shift

Sets the DMRS Cyclic Shift for all the PUSCH Slots when Detection is Auto.

Key Path	Meas Setup, Chan Profile Setup, Edit User Mapping, PUSCH,DMRS Cyclic Shift Couple
Mode	LTE, LTETDD
Remote Command	[:SENSe] :EVM:ULINk:PROFile:AUTO:PUSCh:DMRS:CSHift <integer> [:SENSe] :EVM:ULINk:PROFile:AUTO:PUSCh:DMRS:CSHift?

LTE Modulation Analysis Measurement
Meas Setup (Measurement Setup)

Example	EVM:ULIN:PROF:AUTO:PUSC:DMRS:CSH 1 EVM:ULIN:PROF:AUTO:PUSC:DMRS:CSH?
Notes	Changes to this parameter will not be applied until Update Changes command is sent. See “RB Parameter Manager (Uplink)” on page 1118 section for more details.
Dependencies	Enabled when Detection is Auto and Auto Detect DMRS Params is Off.
Preset	0
State Saved	Saved in instrument state.
Min	0
Max	11
Initial S/W Revision	Prior to A.02.00
Modified at S/W Revision	A.03.00

DMRS Cyclic Shift Couple

Determines whether or not all the PUSCH Slots will use the Common DMRS Cyclic Shift value.

Key Path	Meas Setup, Chan Profile Setup, Edit User Mapping, PUSCH,DMRS Cyclic Shift Couple
Mode	LTE, LTETDD
Remote Command	[:SENSe] :EVM:ULINk:PROFile:USER<n>:PUSCh:DMRS:CSHift:COUPle OFF ON 0 1 [:SENSe] :EVM:ULINk:PROFile:USER<n>:PUSCh:DMRS:CSHift:COUPle?
Example	EVM:ULIN:PROF:USER1:PUSC:DMRS:CSH:COUP ON EVM:ULIN:PROF:USER1:PUSC:DMRS:CSH:COUP?
Notes	Changes to this parameter will not be applied until Update Changes command is sent. See “RB Parameter Manager (Uplink)” on page 1118 section for more details.
Dependencies	The range of sub op code <n> values is determined by the number of Users the user has configured. Max value for n = 50.If the user attempts to remotely set or query a sub op code that is out of range, this will result in an error message. Enabled when Detection is Manual, DMRS Params is Off, and PUSCH Active is ON.
Preset	ON
State Saved	Saved in instrument state.
Initial S/W Revision	Prior to A.02.00
Modified at S/W Revision	A.03.00

Common DMRS Power Boost

Specifies the value to set DMRS power equal to for a slot.

Key Path	Meas Setup, Chan Profile Setup, Edit User Mapping, PUSCH
----------	---

DMRS Power Boost

Sets the DMRS Power Boost value for all the PUSCH Slots when DMRS Power Boost Couple is On and Detection is Manual.

NOTE

All channel and signal powers are relative to the power of the channel/signal chosen for synchronization.

For example, when PUSCH DMRS is chosen for synchronization, setting PUSCH DMRS Power = 2 dB and PUSCH Power = 0.1 dB means that the demodulator will expect PUSCH average power level to be 1.9 dB below the average DMRS power level.

Key Path	Meas Setup, Chan Profile Setup, Edit User Mapping, PUSCH,Couple DMRS Power
Mode	LTE, LTETDD
Remote Command	[:SENSe] :EVM:ULINk:PROFile:USER<n>:PUSCh:DMRS:PWRBoost <rel_ampl> [:SENSe] :EVM:ULINk:PROFile:USER<n>:PUSCh:DMRS:PWRBoost?
Example	EVM:ULIN:PROF:USER1:PUSC:DMRS:PWRB 0 EVM:ULIN:PROF:USER1:PUSC:DMRS:PWRB?
Notes	Changes to this parameter will not be applied until Update Changes command is sent. See “RB Parameter Manager (Uplink)” on page 1118 section for more details.
Dependencies	The range of sub op code <n> values is determined by the number of Users the user has configured. Max value for n = 50. If the user attempts to remotely set or query a sub op code that is out of range, this will result in an error message. Enabled when Detection is Manual, DMRS Power Boost Couple is ON, and PUSCH Active is ON.
Preset	0 dB
State Saved	Saved in instrument state.
Min	-100 dB
Max	100 dB
Initial S/W Revision	Prior to A.02.00
Modified at S/W Revision	A.03.00

LTE Modulation Analysis Measurement
Meas Setup (Measurement Setup)

Modified at S/W Revision	A.04.20
--------------------------	---------

Auto Detect DMRS Power Boost

Sets the DMRS Power Boost value for all the PUSCH Slots when Detection is Auto.

Key Path	Meas Setup, Chan Profile Setup, Edit User Mapping, PUSCH,Couple DMRS Power
Mode	LTE, LTETDD
Remote Command	[:SENSe]:EVM:ULINk:PROFile:AUTO:PUSCh:DMRS:PWRBoost <rel_ampl> [:SENSe]:EVM:ULINk:PROFile:AUTO:PUSCh:DMRS:PWRBoost?
Example	EVM:ULIN:PROF:AUTO:PUSC:DMRS:PWRB 0 EVM:ULIN:PROF:AUTO:PUSC:DMRS:PWRB?
Notes	Changes to this parameter will not be applied until Update Changes command is sent. See “RB Parameter Manager (Uplink)” on page 1118 section for more details.
Dependencies	Enabled when Detection is Auto and Auto Detect PUSCH Active is ON.
Preset	0 dB
State Saved	Saved in instrument state.
Min	-100 dB
Max	100 dB
Initial S/W Revision	Prior to A.02.00
Modified at S/W Revision	A.03.00
Modified at S/W Revision	A.04.20

DMRS Power Boost Couple

Determines whether or not all the PUSCH Slots will use the Common DMRS Power Boost value.

Key Path	Meas Setup, Chan Profile Setup, Edit User Mapping, PUSCH,Couple DMRS Power
Mode	LTE, LTETDD
Remote Command	[:SENSe]:EVM:ULINk:PROFile:USER<n>:PUSCh:DMRS:PWRBoost : COUPlE OFF ON 0 1 [:SENSe]:EVM:ULINk:PROFile:USER<n>:PUSCh:DMRS:PWRBoost : COUPlE
Example	EVM:ULIN:PROF:USER1:PUSC:DMRS:PWRB:COUP ON EVM:ULIN:PROF:USER1:PUSC:DMRS:PWRB:COUP?

Notes	Changes to this parameter will not be applied until Update Changes command is sent. See “RB Parameter Manager (Uplink)” on page 1118 section for more details.
Dependencies	The range of sub op code <n> values is determined by the number of Users the user has configured. Max value for n = 50. If the user attempts to remotely set or query a sub op code that is out of range, this will result in an error message. Enabled when Detection is Manual and PUSCH Active is ON.
Preset	ON
State Saved	Saved in instrument state.
Initial S/W Revision	Prior to A.02.00
Modified at S/W Revision	A.03.00

Common CURRENT_TX_NB

Specifies whether or not allocation is mirrored.

Key Path	Meas Setup, Chan Profile Setup, Edit User Mapping, PUSCH
----------	---

Common CURRENT_TX_NB

Selects CURRENT_TX_NB when Detection is Manual.

CUURRENT_TX_NB specifies whether or not allocation is mirrored.

Key Path	Meas Setup, Chan Profile Setup, Edit User Mapping
Mode	LTE, LTETDD
Remote Command	[:SENSe]:EVM:ULINk:PROFile:USER1 50:PUSCh:CTNB EVEN ODD [:SENSe]:EVM:ULINk:PROFile:USER1 50:PUSCh:CTNB?
Remote Command	[:SENSe]:EVM:ULINk:PROFile:USER<n>:PUSCh:CTNB EVEN ODD [:SENSe]:EVM:ULINk:PROFile:USER<n>:PUSCh:CTNB?
Example	EVM:ULIN:PROF:USER1:PUSC:CTNB EVEN EVM:ULIN:PROF:USER1:PUSC:CTNB?
Notes	Changes to this parameter will not be applied until Update Changes command is sent. See “RB Parameter Manager (Uplink)” on page 1118 section for more details.
Dependencies	Enabled when Detection is Manual, PUSCH Active is ON, and CURRENT_TX_NB Couple is ON. Disabled when Intra/Inter-SF hopping is selected for Frequency Hopping Mode.
Preset	EVEN

LTE Modulation Analysis Measurement
Meas Setup (Measurement Setup)

State Saved	Saved in instrument state.
Range	Even Odd
Initial S/W Revision	A.03.00

CURRENT_TX_NB Couple

Determines whether or not all the PUSCH Slots will use the Common CURRENT_TX_NB value.

Key Path	Meas Setup, Chan Profile Setup, Edit User Mapping
Mode	LTE, LTETDD
Remote Command	[:SENSe] :EVM:ULINk:PROFile:USER<n>:PUSCh:CTNB:COUPle OFF ON 0 1 [:SENSe] :EVM:ULINk:PROFile:USER<n>:PUSCh:CTNB:COUPle?
Example	EVM:ULIN:PROF:USER1:PUSC:CTNB:COUP OFF EVM:ULIN:PROF:USER1:PUSC:CTNB:COUP?
Notes	Changes to this parameter is applied until Update Changes command is sent. See “RB Parameter Manager (Uplink)” on page 1118 section for more details.
Dependencies	Enabled when Detection is Manual and PUSCH Active is ON.
Preset	ON
State Saved	Saved in instrument state.
Initial S/W Revision	A.03.00

PUSCH Slots Parameters

Sets all RB allocation for each slot.

Key Path	Meas Setup, Chan Profile Setup, Edit User Mapping, PUSCH
----------	---

Slot RB Start

Sets the Start Resource Block for the selected PUSCH Slot.

Key Path	Meas Setup, Chan Profile Setup, Edit User Mapping, PUSCH, RB Start
Mode	LTE, LTETDD
Remote Command	[:SENSe] :EVM:ULINk:PROFile:USER<n>:PUSCh:SLOT<m>:RB:STARt <integer> [:SENSe] :EVM:ULINk:PROFile:USER<n>:PUSCh:SLOT<m>:RB:STARt?
Example	EVM:ULIN:PROF:USER1:PUSC:SLOT0:RB:STAR 0 EVM:ULIN:PROF:USER1:PUSC:SLOT0:RB:STAR?

Notes	<p>The index <m> in the above SCPI command is the allocation index, not the slot position. See the “Add PUSCH Slot” on page 1041 command for an explanation of the difference.</p> <p>Changes to this parameter will not be applied until Update Changes command is sent. See “RB Parameter Manager (Uplink)” on page 1118 section for more details.</p>
Dependencies	<p>The range of sub op code <n> values is determined by the number of Users the user has configured. The range of sub op code <m> values is determined by the number of Slots the user has configured. . Max value for n=50. The range of sub op code <m> values is 0 – 19.</p> <p>If the user attempts to remotely set or query a sub op code that is out of range, this will result in an error message.</p> <p>Enabled when RB Start Couple is OFF and PUSCH Active is ON.</p>
Couplings	<p>If the user attempts to set a RB Start value greater than the RB End value, both values will be set to the RB Start value or clipped to the min or max value if the entered value is out of range.</p> <p>Max value is dependent on Bandwidth.</p>
Preset	0
State Saved	Saved in instrument state.
Min	0
Max	<p>5 – Bandwidth 1.4 MHz</p> <p>14 – Bandwidth 3 MHz</p> <p>24 – Bandwidth 5 MHz</p> <p>49 – Bandwidth 10 MHz</p> <p>74 – Bandwidth 15 MHz</p> <p>99 – Bandwidth 20 MHz</p>
Initial S/W Revision	Prior to A.02.00
Modified at S/W Revision	A.03.00

Slot RB End

Sets the Stop Resource Block for the selected PUSCH Slot.

Key Path	Meas Setup, Chan Profile Setup, Edit User Mapping, PUSCH, RB End
Mode	LTE, LTETDD
Remote Command	<pre>[:SENSe]:EVM:ULINK:PROfile:USER<n>:PUSCh:SLOT<m>:RB:END <integer></pre> <pre>[:SENSe]:EVM:ULINK:PROfile:USER<n>:PUSCh:SLOT<m>:RB:END ?</pre>

LTE Modulation Analysis Measurement
Meas Setup (Measurement Setup)

Example	EVM:ULIN:PROF:USER1:PUSC:SLOT0:RB:END 0 EVM:ULIN:PROF:USER1:PUSC:SLOT0:RB:END?
Notes	The index <m> in the above SCPI command is the allocation index, not the slot position. See the “Add PUSCH Slot” on page 1041 command for an explanation of the difference. Changes to this parameter will not be applied until Update Changes command is sent. See “RB Parameter Manager (Uplink)” on page 1118 section for more details.
Dependencies	The range of sub op code <n> values is determined by the number of Users the user has configured. The range of sub op code <m> values is determined by the number of Slots the user has configured. . Max value for n = 50. The range of sub op code <m> values is 0 – 19. If the user attempts to remotely set or query a sub op code that is out of range, this will result in an error message. Enabled when RB End Couple is OFF and PUSCH Active is ON.
Couplings	If the user attempts to set a RB End value less than the RB Start value, both values will be set to the RB End value or clipped to the min or max value if the entered value is out of range. Max value is dependent on Bandwidth.
Preset	0
State Saved	Saved in instrument state.
Min	0
Max	5 – Bandwidth 1.4 MHz 14 – Bandwidth 3 MHz 24 – Bandwidth 5 MHz 49 – Bandwidth 10 MHz 74 – Bandwidth 15 MHz 99 – Bandwidth 20 MHz
Initial S/W Revision	Prior to A.02.00
Modified at S/W Revision	A.03.00

Slot Mod Type

Selects the Modulation Type for the selected PUSCH Slot.

Key Path	Meas Setup, Chan Profile Setup, Edit User Mapping, PUSCH, Mod Type
Mode	LTE, LTETDD

Remote Command	[:SENSE]:EVM:ULINK:PROFile:USER<n>:PUSCh:SLOT<m>:MODulation:TYPE QPSK QAM16 QAM64 [:SENSE]:EVM:ULINK:PROFile:USER<n>:PUSCh:SLOT<m>:MODulation:TYPE?
Example	EVM:ULIN:PROF:USER1:PUSC:SLOT0:MOD:TYPE QPSK EVM:ULIN:PROF:USER1:PUSC:SLOT0:MOD:TYPE?
Notes	The index <m> in the above SCPI command is the allocation index, not the slot position. See the “Add PUSCH Slot” on page 1041 command for an explanation of the difference. Changes to this parameter will not be applied until Update Changes command is sent. See “RB Parameter Manager (Uplink)” on page 1118 section for more details.
Dependencies	The range of sub op code <n> values is determined by the number of Users the user has configured. The range of sub op code <m> values is determined by the number of Slots the user has configured. . Max value for n = 50. The range of sub op code <m> values is 0 – 19. If the user attempts to remotely set or query a sub op code that is out of range, this will result in an error message. Enabled when Mod Type Couple is OFF and PUSCH Active is ON.
Preset	QPSK
State Saved	Saved in instrument state.
Range	QPSK QAM16 QAM64
Initial S/W Revision	Prior to A.02.00
Modified at S/W Revision	A.03.00

QPSK

Selects QPSK for the Modulation Type of the selected PUSCH Slot.

Key Path	Meas Setup, Chan Profile Setup, Edit User Mapping, PUSCH, Mod Type
Mode	LTE, LTETDD
Initial S/W Revision	Prior to A.02.00
Modified at S/W Revision	A.03.00

16QAM

Selects 16QAM for the Modulation Type of the selected PUSCH Slot.

Key Path	Meas Setup, Chan Profile Setup, Edit User Mapping, PUSCH, Mod Type
Mode	LTE, LTETDD
Initial S/W Revision	Prior to A.02.00

LTE Modulation Analysis Measurement
Meas Setup (Measurement Setup)

Modified at S/W Revision	A.03.00
--------------------------	---------

64QAM

Selects 64QAM for the Modulation Type of the selected PUSCH Slot.

Key Path	Meas Setup, Chan Profile Setup, Edit User Mapping, PUSCH, Mod Type
Mode	LTE, LTETDD
Initial S/W Revision	Prior to A.02.00
Modified at S/W Revision	A.03.00

Slot Power Boost

Sets the Power Boost value for the selected PUSCH Slot.

Key Path	Meas Setup, Chan Profile Setup, Edit User Mapping, PUSCH, Power Boost
Mode	LTE, LTETDD
Remote Command	[:SENSE] :EVM:ULINK:PROFile:USER<n>:PUSCh:SLOT<m>:PWRBoo st <rel_ampl> [:SENSE] :EVM:ULINK:PROFile:USER<n>:PUSCh:SLOT<m>:PWRBoo st?
Example	EVM:ULIN:PROF:USER1:PUSC:SLOT0:PWRB 0 EVM:ULIN:PROF:USER1:PUSC:SLOT0:PWRB?
Notes	The index <m> in the above SCPI command is the allocation index, not the slot position. See the “Add PUCCH Slot” on page 1084 PUCCH Slot command for an explanation of the difference. Changes to this parameter will not be applied until Update Changes command is sent. See “RB Parameter Manager (Uplink)” on page 1118 section for more details.
Dependencies	The range of sub op code <n> values is determined by the number of Users the user has configured. The range of sub op code <m> values is determined by the number of Slots the user has configured. . Max value for n = 50. The range of sub op code <m> values is 0 – 19. If the user attempts to remotely set or query a sub op code that is out of range, this will result in an error message. Enabled when Power Boost Couple is OFF and PUSCH Active is ON.
Preset	0 dB
State Saved	Saved in instrument state.
Min	–100 dB
Max	100 dB

Initial S/W Revision	Prior to A.02.00
Modified at S/W Revision	A.03.00
Modified at S/W Revision	A.04.20

Slot DMRS Group

Specifies the DMRS Group for the selected PUSCH Slot.

Key Path	Meas Setup, Chan Profile Setup, Edit User Mapping, PUSCH,DMRS Group
Mode	LTE, LTETDD
Remote Command	[:SENSe]:EVM:ULINk:PROfile:USER<n>:PUSCh:SLOT<m>:DMRS:GROup <integer> [:SENSe]:EVM:ULINk:PROfile:USER<n>:PUSCh:SLOT<m>:DMRS:GROup?
Example	EVM:ULIN:PROF:USER1:PUSC:SLOT0:DMRS:GRO 1 EVM:ULIN:PROF:USER1:PUSC:SLOT0:DMRS:GRO?
Notes	The index <m> in the above SCPI command is the allocation index, not the slot position. See the “Add PUSCH Slot” on page 1041 command for an explanation of the difference. Changes to this parameter will not be applied until Update Changes command is sent. See “RB Parameter Manager (Uplink)” on page 1118 section for more details.
Dependencies	The range of sub op code <n> values is determined by the number of Users the user has configured. The range of sub op code <m> values is determined by the number of Slots the user has configured. . Max value for n = 50. The range of sub op code <m> values is 0 – 19.If the user attempts to remotely set or query a sub op code that is out of range, this will result in an error message. Enabled when DMRS Params is OFF, DMRS Group Couple is OFF, and PUSCH Active is ON.
Preset	0
State Saved	Saved in instrument state.
Min	0
Max	29
Initial S/W Revision	Prior to A.02.00
Modified at S/W Revision	A.03.00

Slot DMRS Sequence

Specifies the DMRS Sequence (v) for the selected PUSCH. DMRS Sequence or v, is the sequence number within the group and can take on values from 0 to $\text{floor}(N_{ZC}^{RS}/30)-1$, where N_{ZC}^{RS} is the largest prime number less than

LTE Modulation Analysis Measurement
Meas Setup (Measurement Setup)

M_{SC}^{RS}

Key Path	Meas Setup, Chan Profile Setup, Edit User Mapping, PUSCH,DMRS Seq
Mode	LTE, LTETDD
Remote Command	[:SENSe] :EVM:ULINk:PROFile:USER<n>:PUSCh:SLOT<m>:DMRS:SEQuence <integer> [:SENSe] :EVM:ULINk:PROFile:USER<n>:PUSCh:SLOT<m>:DMRS:SEQuence?
Example	EVM:ULIN:PROF:USER1:PUSC:SLOT0:DMRS:SEQ 1 EVM:ULIN:PROF:USER1:PUSC:SLOT0:DMRS:SEQ?
Notes	The index <m> in the above SCPI command is the allocation index, not the slot position. See the “Add PUSCH Slot” on page 1041 command for an explanation of the difference. Changes to this parameter will not be applied until Update Changes command is sent. See “RB Parameter Manager (Uplink)” on page 1118 section for more details.
Dependencies	The range of sub op code <n> values is determined by the number of Users the user has configured. The range of sub op code <m> values is determined by the number of Slots the user has configured. . Max value for n = 50. The range of sub op code <m> values is 0 – 19. If the user attempts to remotely set or query a sub op code that is out of range, this will result in an error message. Enabled when DMRS Params is OFF, DMRS Sequence Couple is OFF and PUSCH Active is ON.
Preset	0
State Saved	Saved in instrument state.
Min	0
Max	$\text{floor}(N_{ZC}^{RS}/30)-1$ (can be restricted based on bandwidth)
Initial S/W Revision	Prior to A.02.00
Modified at S/W Revision	A.03.00

Slot DMRS Cyclic Shift

Specifies the DMRS Cyclic Shift for the selected PUSCH Slot.

Key Path	Meas Setup, Chan Profile Setup, Edit User Mapping, PUSCH,DMRS Cyclic Shift
Mode	LTE, LTETDD

Remote Command	[:SENSE]:EVM:ULINK:PROFile:USER<n>:PUSCh:SLOT<m>:DMRS:CShift <integer> [:SENSE]:EVM:ULINK:PROFile:USER<n>:PUSCh:SLOT<m>:DMRS:CShift?
Example	EVM:ULIN:PROF:USER1:PUSC:SLOT0:DMRS:CSH 1 EVM:ULIN:PROF:USER1:PUSC:SLOT0:DMRS:CSH?
Notes	The index <m> in the above SCPI command is the allocation index, not the slot position. See the “Add PUSCH Slot” on page 1041 command for an explanation of the difference. Changes to this parameter will not be applied until Update Changes command is sent. See “RB Parameter Manager (Uplink)” on page 1118 section for more details.
Dependencies	The range of sub op code <n> values is determined by the number of Users the user has configured. The range of sub op code <m> values is determined by the number of Slots the user has configured. . Max value for n = 50. The range of sub op code <m> values is 0 – 19. If the user attempts to remotely set or query a sub op code that is out of range, this will result in an error message. Enabled when DMRS Params is OFF, DMRS Cyclic Shift Couple is OFF, and PUSCH Active is ON.
Preset	0
State Saved	Saved in instrument state.
Min	0
Max	11
Initial S/W Revision	Prior to A.02.00
Modified at S/W Revision	A.03.00

Slot DMRS Power Boost

Sets the DMRS Power Boost value for the selected PUSCH Slot.

Key Path	Meas Setup, Chan Profile Setup, Edit User Mapping, PUSCH, DMRS Power Boost
Mode	LTE, LTETDD
Remote Command	[:SENSE]:EVM:ULINK:PROFile:USER<n>:PUSCh:SLOT<m>:DMRS:PWRBoost <rel_ampl> [:SENSE]:EVM:ULINK:PROFile:USER<n>:PUSCh:SLOT<m>:DMRS:PWRBoost?
Example	EVM:ULIN:PROF:USER1:PUSC:SLOT0:DMRS:PWRB 0 EVM:ULIN:PROF:USER1:PUSC:SLOT0:DMRS:PWRB?

LTE Modulation Analysis Measurement
Meas Setup (Measurement Setup)

Notes	<p>The index <m> in the above SCPI command is the allocation index, not the slot position. See the “Add PUSCH Slot” on page 1041 command for an explanation of the difference.</p> <p>Changes to this parameter will not be applied until Update Changes command is sent. See “RB Parameter Manager (Uplink)” on page 1118 section for more details.</p>
Dependencies	<p>The range of sub op code <n> values is determined by the number of Users the user has configured. The range of sub op code <m> values is determined by the number of Slots the user has configured. . Max value for n = 50. The range of sub op code <m> values is 0 – 19.</p> <p>If the user attempts to remotely set or query a sub op code that is out of range, this will result in an error message.</p> <p>Enabled when DMRS Power Boost Couple is OFF and PUSCH Active is ON.</p>
Preset	0 dB
State Saved	Saved in instrument state.
Min	–100 dB
Max	100 dB
Initial S/W Revision	Prior to A.02.00
Modified at S/W Revision	A.03.00
Modified at S/W Revision	A.04.20

Slot CURRENT_TX_NB

Sets the CURRENT_TX_NB for the selected PUSCH Slot.

Key Path	Meas Setup, Chan Profile Setup, Edit User Mapping
Mode	LTE, LTETDD
Remote Command	<pre>[:SENSe]:EVM:ULINk:PROFile:USER<n>:PUSCh:SLOT<m>:CTNB OFF ON 0 1 [:SENSe]:EVM:ULINk:PROFile:USER<n>:PUSCh:SLOT<m>:CTNB?</pre>
Example	<pre>EVM:ULIN:PROF:USER1:PUSC:SLOT0:CTNB OFF EVM:ULIN:PROF:USER1:PUSC:SLOT0:CTNB?</pre>
Notes	<p>The range of sub op code <n> values is determined by the number of Users the user has configured. The range of sub op code <m> values is determined by the number of Slots the user has configured. . Max value for n = 50. The range of sub op code <m> values is 0 – 19.</p> <p>Changes to this parameter will not be applied until Update Changes command is sent. See “RB Parameter Manager (Uplink)” on page 1118 section for more details.</p>

Dependencies	Enabled when Detection is Manual, Current TX NB Couple is OFF, and PUSCH Active is ON. Disabled when Intra/Inter-SF hopping is selected for Frequency Hopping Mode.
Preset	EVEN
State Saved	Saved in instrument state.
Range	Even Odd
Initial S/W Revision	A.03.00

Add PUSCH Slot

Adds a new allocation in the slot position specified, if available. The new allocation will have its parameters set to the default values. It is put into a collection of allocations in ascending order of slot position. The SCPI commands that follow are used to set slot allocation parameters, such as RB start and end. They all contain the mnemonic SLOT<m>, where <m> is an index into the collection of allocations. The index ranges from 0 to a maximum of 19. Do not confuse the allocation index with the slot position.

To avoid confusion, you should make PUSCH allocations in ascending order of slot position.

For example, if you wished to add 4 allocations for User1 at slot positions 2, 4, 7, and 10, use the following commands in order:

```
EVM:ULIN:PROF:USER1:PUSC:ADD:SLOT 2
```

```
EVM:ULIN:PROF:USER1:PUSC:ADD:SLOT 4
```

```
EVM:ULIN:PROF:USER1:PUSC:ADD:SLOT 7
```

```
EVM:ULIN:PROF:USER1:PUSC:ADD:SLOT 10
```

You now have four allocations. Allocation 0 is at slot position 2, allocation 1 at slot position 4, allocation 2 at slot position 7, and allocation 3 at slot position 10. The allocations are referenced as SLOT0, SLOT1, SLOT2, and SLOT3 in the commands that follow. For example, if you want to verify the slot position of the third allocation, send the query:

```
EVM:ULIN:PROF:USER1:PUSC:SLOT2:POS?
```

This will return 7 for the example above.

Note that if you delete an allocation, the indices of the allocations above it reduce by 1. To continue the previous example, if you send the command:

```
EVM:ULIN:PROF:USER1:PUSC:SLOT1:DEL
```

This removes the allocation at slot position 4. The allocations at slot positions 7 and 10 are now referenced as SLOT1 and SLOT2, whereas before they were referenced as SLOT2 and SLOT3.

Key Path	Meas Setup, Chan Profile Setup, Edit User Mapping, PUSCH, Slot
Mode	LTE, LTETDD
Remote Command	[:SENSE] :EVM:ULINK:PROF:USER<n>:PUSCh:ADD:SLOT <integer>
Example	EVM:ULIN:PROF:USER1:PUSC:ADD:SLOT 0

LTE Modulation Analysis Measurement
Meas Setup (Measurement Setup)

Notes	<p>The softkey for this parameter is an Immediate Action key. The value that is passed in by the SCPI command enables the user to position the allocation at a particular slot.</p> <p>Changes to this parameter will not be applied until Update Changes command is sent. See “RB Parameter Manager (Uplink)” on page 1118 section for more details.</p>
Dependencies	<p>The range of sub op code <n> values is determined by the number of Users the user has configured.</p> <p>If the user attempts to add a Slot to a User and the slot is already allocated, an error message will be generated.</p> <p>Disabled once the number of Slots reaches to 20, the max number.</p>
Preset	0
State Saved	Saved in instrument state.
Min	0
Max	19
Initial S/W Revision	Prior to A.02.00
Modified at S/W Revision	A.03.00

Delete PUSCH Slot

Deletes the currently selected slot allocation.

Key Path	Meas Setup, Chan Profile Setup, Edit User Mapping, PUSCH, Slot
Mode	LTE, LTETDD
Remote Command	[:SENSe] :EVM:ULINk:PROFile:USER<n>:PUSCh:SLOT<m>:DELeTe
Example	EVM:ULIN:PROF:USER1:PUSC:SLOT1:DEL
Notes	<p>The index <m> in the above SCPI command is the allocation index, not the slot position. See the “Add PUSCH Slot” on page 1041 command for an explanation of the difference.</p> <p>Changes to this parameter will not be applied until Update Changes command is sent. See “RB Parameter Manager (Uplink)” on page 1118 section for more details.</p>
Dependencies	<p>Disabled when there is only one Slot.</p> <p>The range of sub op code <n> values is determined by the number of Users the user has configured. The range of sub op code <m> values is determined by the number of Slots the user has configured. . Max value for n=50. The range of sub op code <m> values is 0 – 19.</p> <p>If the user attempts to delete a Slot that does not exist, an error message will be generated.</p>
Initial S/W Revision	Prior to A.02.00

Modified at S/W Revision	A.03.00
--------------------------	---------

Move Up

Moves the currently selected Slot up.

See also [“Slot Position” on page 1043](#) query

Key Path	Meas Setup, Chan Profile Setup, Edit User Mapping, PUSCH, Slot
Mode	LTE, LTETDD
Dependencies	Disabled when there are no Slots defined or if the slot is at Slot19.
Initial S/W Revision	Prior to A.02.00
Modified at S/W Revision	A.03.00

Move Down

Moves the currently selected Slot down .

See also [“Slot Position” on page 1043](#) query

Key Path	Meas Setup, Chan Profile Setup, Edit User Mapping, PUSCH, Slot
Mode	LTE, LTETDD
Dependencies	Disabled when there are no Slots defined or if the slot is at Slot0.
Initial S/W Revision	Prior to A.02.00
Modified at S/W Revision	A.03.00

Slot Position

Queries the PUSCH slot start position.

Key Path	SCPI Only
Mode	LTE, LTETDD
Remote Command	[:SENSE] :EVM:ULINK:PROFile:USER<n>:PUSCh:SLOT<m>:POSiti on?
Example	EVM:ULIN:PROF:USER1:PUSC:SLOT0:POS?
Notes	The index <m> in the above SCPI command is the allocation index, not the slot position. See the “Add PUSCH Slot” on page 1041 command for an explanation of the difference.
Dependencies	The range of sub op code <n> values is determined by the number of Users the user has configured. The range of sub op code <m> values is determined by the number of Slots the user has configured. Max value for n = 50. The range of sub op code <m> values is 0 – 19.
Preset	0

LTE Modulation Analysis Measurement
Meas Setup (Measurement Setup)

State Saved	Saved in instrument state.
Min	0
Max	19
Initial S/W Revision	Prior to A.02.00
Modified at S/W Revision	A.03.00

PUCCH Parameters

Displays a menu that enables you to select PUCCH parameters for signals.

Key Path	Meas Setup, Chan Profile Setup, Edit User Mapping, PUCCH Parameters
Mode	LTE, LTETDD
Initial S/W Revision	Prior to A.02.00
Modified at S/W Revision	A.03.00

PUCCH Active

Selects whether or not PUCCH exists in the input signal when Detection is Manual.

Key Path	Meas Setup, Chan Profile Setup, Edit User Mapping
Mode	LTE, LTETDD
Remote Command	[:SENSE] :EVM:ULINK:PROFile:USER1 50:PUCCh:ACTive OFF ON 0 1 [:SENSE] :EVM:ULINK:PROFile:USER1 50:PUCCh:ACTive?
Example	EVM:ULIN:PROF:USER1:PUCCh:ACT OFF EVM:ULIN:PROF:USER1:PUCCh:ACT?
Notes	Changes to this parameter will not be applied until Update Changes command is sent. See “RB Parameter Manager (Uplink)” on page 1118 section for more details.
Dependencies	Enabled when Detection is Manual. All soft keys for PUCCH parameter are grayed out when this parameter is OFF.
Preset	OFF
State Saved	Saved in instrument state.
Initial S/W Revision	A.03.00

Auto Detect PUCCH Active

Selects whether or not PUCCH exists in the input signal when Detection is Auto.

Key Path	Meas Setup, Chan Profile Setup, Edit User Mapping
Mode	LTE, LTETDD
Remote Command	[:SENSe]:EVM:ULINk:PROFile:AUTO:PUCCh:ACTive OFF ON 0 1 [:SENSe]:EVM:ULINk:PROFile:AUTO:PUCCh:ACTive?
Example	EVM:ULIN:PROF:AUTO:PUCCh:ACT OFF EVM:ULIN:PROF:AUTO:PUCCh:ACT?
Notes	Changes to this parameter will not be applied until Update Changes command is sent. See “RB Parameter Manager (Uplink)” on page 1118 section for more details.
Dependencies	Enabled when Detection is Auto.
Preset	OFF
State Saved	Saved in instrument state.
Initial S/W Revision	A.03.00

DMRS Params

Determines if all DMRS parameters to be used are common to all Slots or if they are to be defined on a per Slot basis when Detection is Manual.

Enabling this parameter sets PUCCH Per-slot Parameters First RB, Cyclic Shift, OS, and DMRS Group (u) to be automatically calculated given the parameters $N_{RB}^{(2)}$, $N_{CS}^{(1)}$, $n_{PUCCH}^{(1)}$, $n_{PUCCH}^{(2)}$, D_{shift}^{PUCCH} parameters that are defined in 3GPP TS 36.211.

Key Path	Meas Setup, Chan Profile Setup, Edit User Mapping, PUCCH, DMRS Params
Mode	LTE, LTETDD
Remote Command	[:SENSe]:EVM:ULINk:PROFile:USER<n>:PUCCh:DMRS:PARams OFF ON 0 1 [:SENSe]:EVM:ULINk:PROFile:USER<n>:PUCCh:DMRS:PARams?
Example	EVM:ULIN:PROF:USER1:PUCCh:DMRS:PAR OFF EVM:ULIN:PROF:USER1:PUCCh:DMRS:PAR?
Notes	Changes to this parameter will not be applied until Update Changes command is sent. See “RB Parameter Manager (Uplink)” on page 1118 section for more details.

LTE Modulation Analysis Measurement
Meas Setup (Measurement Setup)

Dependencies	<p>The range of sub op code <n> values is determined by the number of Users the user has configured.</p> <p>If the user attempts to remotely set or query a sub op code that is out of range, this will result in an error message.</p> <p>When this parameter is on, $N_{RB}(2)$, $N_{CS}(1)$, $n_{PUCCH}(1)$, $n_{PUCCH}(2)$, and PUCCH Shift are enabled and First RB, Cyclic Shift, OS and DMRS Group (u) are disabled.</p> <p>Enabled when Detection is Manual and PUCCH Active is ON.</p>
Preset	ON
State Saved	Saved in instrument state.
Initial S/W Revision	A.03.00

Auto Detect DMRS Params

Determines if all DMRS parameters are common to all Slots for PUCCH or if they are to be defined on a per Slot basis when Detection is Auto.

Key Path	Meas Setup, Chan Profile Setup, Edit User Mapping, PUCCH, DMRS Params
Mode	LTE, LTETDD
Remote Command	<pre>[:SENSe] :EVM:ULINK:PROF:le:AUTO:PUCCh:DMRS:PARams OFF ON 0 1</pre> <pre>[:SENSe] :EVM:ULINK:PROF:le:AUTO:PUCCh:DMRS:PARams?</pre>
Example	<pre>EVM:ULIN:PROF:AUTO:PUCCh:DMRS:PAR OFF</pre> <pre>EVM:ULIN:PROF:AUTO:PUCCh:DMRS:PAR?</pre>
Notes	Changes to this parameter will not be applied until Update Changes command is sent. See “RB Parameter Manager (Uplink)” on page 1118 section for more details.
Dependencies	<p>When this parameter is on, $N_{RB}(2)$, $N_{CS}(1)$, $n_{PUCCH}(1)$, $n_{PUCCH}(2)$, and PUCCH Shift are enabled and First RB, Cyclic Shift, OS and DMRS Group (u) are disabled.</p> <p>Enabled when Detection is AUTO and Auto Detect PUCCH Active is ON.</p>
Preset	ON
State Saved	Saved in instrument state.
Initial S/W Revision	A.03.00

N RB (2)

Sets the $N_{RB}(2)$ for all PUCCH Slots when Detection is Manual.

$N_{RB}(2)$ specifies the number of resource blocks per slot that are available for PUCCH type 2/2a/2b transmissions.

Key Path	Meas Setup, Chan Profile Setup, Edit User Mapping, PUCCH, N RB (2)
Mode	LTE, LTETDD
Remote Command	[:SENSe] :EVM:ULINk:PROFile:USER<n>:PUCCh:NRB:TWO <integer> [:SENSe] :EVM:ULINk:PROFile:USER<n>:PUCCh:NRB:TWO?
Example	EVM:ULIN:PROF:USER1:PUCCh:NRB:TWO 1 EVM:ULIN:PROF:USER1:PUCCh:NRB:TWO?
Notes	Changes to this parameter will not be applied until Update Changes command is sent. See “RB Parameter Manager (Uplink)” on page 1118 section for more details.
Dependencies	The range of sub op code <n> values is determined by the number of Users the user has configured. If the user attempts to remotely set or query a sub op code that is out of range, this will result in an error message. Enabled when Detection is Manual, DMRS Params is On, and PUCCH Active is ON.
Couplings	$N_{RB}(2)$ should always be less than the total RB number of selected Bandwidth Selection.
Preset	0
State Saved	Saved in instrument state.
Min	0
Max	5 – Bandwidth 1.4 MHz 14 – Bandwidth 3 MHz 24 – Bandwidth 5 MHz 49 – Bandwidth 10 MHz 74 – Bandwidth 15 MHz 99 – Bandwidth 20 MHz
Initial S/W Revision	A.03.00

Auto Detect N RB (2)

Sets the $N_{RB}(2)$ for all PUCCH Slots when Detection is Auto.

Key Path	Meas Setup, Chan Profile Setup, Edit User Mapping, PUCCH, N RB (2)
Mode	LTE, LTETDD

LTE Modulation Analysis Measurement
Meas Setup (Measurement Setup)

Remote Command	[:SENSe]:EVM:ULINk:PROFile:AUTO:PUCCh:NRB:TWO <integer> [:SENSe]:EVM:ULINk:PROFile:AUTO:PUCCh:NRB:TWO?
Example	EVM:ULIN:PROF:AUTO:PUCc:NRB:TWO 1 EVM:ULIN:PROF:AUTO:PUCc:NRB:TWO?
Notes	Changes to this parameter will not be applied until Update Changes command is sent. See “ RB Parameter Manager (Uplink) ” on page 1118 section for more details.
Dependencies	If the user attempts to remotely set or query a sub op code that is out of range, this will result in an error message. Enabled when Detection is Auto, Auto Detect PUCCH DMRS Params is On, and Auto Detect PUCCH Active is ON.
Couplings	$N_{RB(2)}$ should always be less than the total RB number of selected Bandwidth Selection.
Preset	0
State Saved	Saved in instrument state.
Min	0
Max	5 – Bandwidth 1.4 MHz 14 – Bandwidth 3 MHz 24 – Bandwidth 5 MHz 49 – Bandwidth 10 MHz 74 – Bandwidth 15 MHz 99 – Bandwidth 20 MHz
Initial S/W Revision	A.03.00

N CS (1)

Sets the $N_{CS(1)}$ for all PUCCH Slots when Detection is Manual.

$N_{CS(1)}$ specifies the number of cyclic shifts used for PUCCH formats 1/1a/1b in a resource block with a mix of formats 1/1a/1b and 2/2a/2b.

Key Path	Meas Setup, Chan Profile Setup, Edit User Mapping, PUCCH, N CS (1)
Mode	LTE, LTETDD
Remote Command	[:SENSe]:EVM:ULINk:PROFile:USER<n>:PUCCh:NCS:ONE <integer> [:SENSe]:EVM:ULINk:PROFile:USER<n>:PUCCh:NCS:ONE?
Example	EVM:ULIN:PROF:USER1:PUCCh:NCS:ONE 1 EVM:ULIN:PROF:USER1:PUCCh:NCS:ONE?

Notes	Changes to this parameter will not be applied until Update Changes command is sent. See “RB Parameter Manager (Uplink)” on page 1118 section for more details.
Dependencies	The range of sub op code <n> values is determined by the number of Users the user has configured. If the user attempts to remotely set or query a sub op code that is out of range, this will result in an error message. Enabled when Detection is Manual, DMRS Params is On, and PUCCH Active is ON.
Preset	0
State Saved	Saved in instrument state.
Min	0
Max	7
Initial S/W Revision	A.03.00

Auto Detect N CS (1)

Sets the $N_{CS}(1)$ for all PUCCH Slots when Detection is Auto.

Key Path	Meas Setup, Chan Profile Setup, Edit User Mapping, PUCCH, N CS (1)
Mode	LTE, LTETDD
Remote Command	[:SENSE] :EVM:ULINK:PROfile:AUTO:PUCCh:NCS:ONE <integer> [:SENSE] :EVM:ULINK:PROfile:AUTO:PUCCh:NCS:ONE?
Example	EVM:ULIN:PROF:AUTO:PUCCh:NCS:ONE 1 EVM:ULIN:PROF:AUTO:PUCCh:NCS:ONE?
Notes	Changes to this parameter will not be applied until Update Changes command is sent. See “RB Parameter Manager (Uplink)” on page 1118 section for more details.
Dependencies	If the user attempts to remotely set or query a sub op code that is out of range, this will result in an error message. Enabled when Detection is Auto, Auto Detect PUCCH DMRS Params is On, and Auto Detect PUCCH Active is ON.
Preset	0
State Saved	Saved in instrument state.
Min	0
Max	7
Initial S/W Revision	A.03.00

LTE Modulation Analysis Measurement
Meas Setup (Measurement Setup)

N PUCCH (2)

Sets the $N_{\text{PUCCH}}(2)$ for all PUCCH Slots when Detection is Manual.

Key Path	Meas Setup, Chan Profile Setup, Edit User Mapping, PUCCH, N PUCCH (2)
Mode	LTE, LTETDD
Remote Command	[:SENSE]:EVM:ULINK:PROFile:USER<n>:PUCCh:N:TWO <integer> [:SENSE]:EVM:ULINK:PROFile:USER<n>:PUCCh:N:TWO?
Example	EVM:ULIN:PROF:USER1:PUCCh:N:TWO 1 EVM:ULIN:PROF:USER1:PUCCh:N:TWO?
Notes	Changes to this parameter will not be applied until Update Changes command is sent. See “RB Parameter Manager (Uplink)” on page 1118 section for more details.
Dependencies	The range of sub op code <n> values is determined by the number of Users the user has configured. If the user attempts to remotely set or query a sub op code that is out of range, this will result in an error message. Enabled when Detection is Manual, DMRS Params is On, and PUCCH Active is ON.
Couplings	$N_{\text{PUCCH}}(2)$ should always be less than the total available subcarrier number of current bandwidth selection.
Preset	0
State Saved	Saved in instrument state.
Min	0
Max	$N_{\text{PUCCH}}^{(2)} < N_{\text{RB}}^{(2)} N_{\text{sc}}^{\text{RB}} + \left\lceil \frac{N_{\text{cs}}^{(1)}}{8} \right\rceil \cdot (N_{\text{sc}}^{\text{RB}} - N_{\text{cs}}^{(1)} - 2)$
Initial S/W Revision	A.03.00

Auto Detect N PUCCH (2)

Sets the $N_{\text{PUCCH}}(2)$ for all PUCCH Slots when Detection is Auto.

Key Path	Meas Setup, Chan Profile Setup, Edit User Mapping, PUCCH, N PUCCH (2)
Mode	LTE, LTETDD
Remote Command	[:SENSE]:EVM:ULINK:PROFile:AUTO:PUCCh:N:TWO <integer> [:SENSE]:EVM:ULINK:PROFile:AUTO:PUCCh:N:TWO?

Example	EVM:ULIN:PROF:AUTO:PUCCh:N:TWO 1 EVM:ULIN:PROF:AUTO:PUCCh:N:TWO?
Notes	Changes to this parameter will not be applied until Update Changes command is sent. See “RB Parameter Manager (Uplink)” on page 1118 section for more details.
Dependencies	If the user attempts to remotely set or query a sub op code that is out of range, this will result in an error message. Enabled when Detection is Auto, Auto Detect PUCCH DMRS Params is On, and Auto Detect PUCCH Active is ON.
Couplings	$N_{\text{PUCCH}}^{(2)}$ should always be less than the total available subcarrier number of current bandwidth selection.
Preset	0
State Saved	Saved in instrument state.
Min	0
Max	$N_{\text{PUCCH}}^{(2)} < N_{\text{RB}}^{(2)} N_{\text{sc}}^{\text{RB}} + \left\lceil \frac{N_{\text{cs}}^{(1)}}{8} \right\rceil \cdot (N_{\text{sc}}^{\text{RB}} - N_{\text{cs}}^{(1)} - 2)$
Initial S/W Revision	A.03.00

PUCCH Shift

Sets the PUCCH Shift for all PUCCH Slots when Detection is Manual.

Key Path	Meas Setup, Chan Profile Setup, Edit User Mapping, PUCCH, PUCCH Shift
Mode	LTE, LTETDD
Remote Command	[:SENSE] :EVM:ULINK:PROF:USER<n>:PUCCh:SHIFt <integer> [:SENSE] :EVM:ULINK:PROF:USER<n>:PUCCh:SHIFt?
Example	EVM:ULIN:PROF:USER1:PUCCh:SHIF 1 EVM:ULIN:PROF:USER1:PUCCh:SHIF?
Notes	Changes to this parameter will not be applied until Update Changes command is sent. See “RB Parameter Manager (Uplink)” on page 1118 section for more details.
Dependencies	The range of sub op code <n> values is determined by the number of Users the user has configured. If the user attempts to remotely set or query a sub op code that is out of range, this will result in an error message. Enabled when Detection is Manual and PUCCH DMRS Params is On.

LTE Modulation Analysis Measurement
Meas Setup (Measurement Setup)

Preset	1
State Saved	Saved in instrument state.
Min	1
Max	3
Initial S/W Revision	A.03.00

Auto Detect PUCCH Shift

Sets the PUCCH Shift for all PUCCH Slots when Detection is Auto.

Key Path	Meas Setup, Chan Profile Setup, Edit User Mapping, PUCCH, PUCCH Shift
Mode	LTE, LTETDD
Remote Command	[:SENSE] :EVM:ULINK:PROFile:AUTO:PUCCh:SHIFt <integer> [:SENSE] :EVM:ULINK:PROFile:AUTO:PUCCh:SHIFt?
Example	EVM:ULIN:PROF:AUTO:PUCc:SHIF 1 EVM:ULIN:PROF:AUTO:PUCc:SHIF?
Notes	Changes to this parameter will not be applied until Update Changes command is sent. See “ RB Parameter Manager (Uplink) ” on page 1118 section for more details.
Dependencies	Enabled when Detection is Auto and Auto Detect PUCCH DMRS Params is On.
Preset	1
State Saved	Saved in instrument state.
Min	1
Max	3
Initial S/W Revision	A.03.00

PUCCH Sync Slot

Sets the Sync Slot for all PUCCH Slots when Detection is Manual.

Sync Slot specifies the index of the slot to use for initial synchronization. The demodulator searches for the slot with the characteristics specified in Per-slot Parameters and the slot that matches the Per-slot Parameters with the highest correlation will be assigned the slot number given in the Sync Slot parameter.

When Sync Slot is set to Auto, the demod algorithm may automatically determine the best time slot to synchronies to. This approach simplifies parameter entry and provides easier setup. However, the complexity of the algorithm makes it rather slow and prone to errors in the presence of noise.

Key Path	Meas Setup, Chan Profile Setup, Edit User Mapping
Mode	LTE, LTETDD

Remote Command	<pre>[:SENSe]:EVM:ULINk:PROFile:USER<n>:PUCCh:SSLot <integer> [:SENSe]:EVM:ULINk:PROFile:USER<n>:PUCCh:SSLot? [:SENSe]:EVM:ULINk:PROFile:USER<n>:PUCCh:SSLot:AUTO OFF ON 0 1 [:SENSe]:EVM:ULINk:PROFile:USER<n>:PUCCh:SSLot:AUTO?</pre>
Example	<pre>EVM:ULIN:PROF:USER1:PUCc:SSL 1 EVM:ULIN:PROF:USER1:PUCc:SSL? EVM:ULIN:PROF:USER1:PUCc:SSL:AUTO 1 EVM:ULIN:PROF:USER1:PUCc:SSL:AUTO?</pre>
Notes	Changes to this parameter will not be applied until Update Changes command is sent. See “RB Parameter Manager (Uplink)” on page 1118 section for more details.
Dependencies	<p>The range of sub op code <n> values is determined by the number of Users the user has configured. Max value for n=50.</p> <p>If the user attempts to remotely set or query a sub op code that is out of range, this will result in an error message.</p> <p>PUCCH Sync Slot is enabled when Detection is Manual, PUCCH Active is ON, and PUCCH Sync Slot Auto is OFF.</p> <p>PUCCH Sync Slot Auto is enabled when Detection is Manual and PUCCH Active is ON.</p>
Preset	0 ON
State Saved	Saved in instrument state.
Min	0
Max	19
Initial S/W Revision	Prior to A.02.00
Modified at S/W Revision	A.03.00

Auto Detect PUCCH Sync Slot

Sets the Sync Slot for all PUCCH Slots when Detection is Auto.

Key Path	Meas Setup, Chan Profile Setup, Edit User Mapping
Mode	LTE, LTETDD

LTE Modulation Analysis Measurement
Meas Setup (Measurement Setup)

Remote Command	[:SENSe]:EVM:ULINk:PROFile:AUTO:PUCCh:SSLot <integer> [:SENSe]:EVM:ULINk:PROFile:AUTO:PUCCh:SSLot? [:SENSe]:EVM:ULINk:PROFile:AUTO:PUCCh:SSLot:AUTO OFF ON 0 1 [:SENSe]:EVM:ULINk:PROFile:AUTO:PUCCh:SSLot:AUTO?
Example	EVM:ULIN:PROF:AUTO:PUCc:SSL 1 EVM:ULIN:PROF:AUTO:PUCc:SSL? EVM:ULIN:PROF:AUTO:PUCc:SSL:AUTO 1 EVM:ULIN:PROF:AUTO:PUCc:SSL:AUTO?
Notes	Changes to this parameter will not be applied until Update Changes command is sent. See section 3.11.8.5.22 RB Parameter Manager (Uplink) for more details.
Dependencies	Auto Detect PUCCH Sync Slot is enabled when Detection is Auto, Auto Detect PUCCH Active is ON, and Auto Detect PUCCH Sync Slot Auto is OFF. Auto Detect PUCCH Sync Slot Auto is enabled when Detection is Auto and Auto Detect PUCCH Active is ON, and “Auto-detect Format/nPUCCH(1)” on page 1054 is Man.
Preset	0 OFF
State Saved	Saved in instrument state.
Min	0
Max	19
Initial S/W Revision	Prior to A.02.00
Modified at S/W Revision	A.03.00, A.10.00

Auto-detect Format/nPUCCH(1)

Enables auto detection of PUCCH Format and $n_{\text{PUCCH}}^{(1)}$ for all subframes. This is useful when the format and/or $n_{\text{PUCCH}}^{(1)}$ value is different for each subframe. When this parameter is set to Manual, if Detection is Auto, PUCCH parameters are auto detected, but PUCCH Format and $n_{\text{PUCCH}}^{(1)}$ are expected to be constant for the entire frame. When this parameter is set to AutoDet, the Auto Detect PUCCH Auto Sync setting will be ignored. When Sync Type is set to PUCCH DMRS, you must define a sync slot by setting the Per-Slot Parameters for the sync slot as well as setting the index using the Sync Slot parameter.

Key Path	Meas Setup, Chan Profile Setup, Edit User Mapping
Mode	LTE, LTETDD

Remote Command	[:SENSe] :EVM:ULINk:PROFile:AUTO:PUCCh:FNPucch:AUTO OFF ON 0 1 [:SENSe] :EVM:ULINk:PROFile:AUTO:PUCCh:FNPucch:AUTO?
Example	EVM:ULIN:PROF:AUTO:PUC:FN:AUTO 1 EVM:ULIN:PROF:AUTO:PUC:FN:AUTO?
Notes	Changes to this parameter will not be applied until Update Changes command is sent. See section 3.11.8.5.22 RB Parameter Manager (Uplink) for more details.
Dependencies	Enabled when Detection is Auto and Auto Detect PUCCH Active is ON.
Preset	ON
State Saved	Saved in instrument state.
Range	AutoDet Man
Initial S/W Revision	A.10.00

PUCCH Couple

Selecting the checkbox next to a parameter in the PUCCH Per-slot Parameters area will couple that parameter across all RB allocation.

Key Path	Meas Setup, Chan Profile Setup, Edit User Mapping, PUCCH
----------	---

Common First RB

Sets the RB index of the selected user's PUCCH allocation for this slot.

Key Path	Meas Setup, Chan Profile Setup, Edit User Mapping, PUCCH
----------	---

First RB

Sets the First Resource Block for all the PUCCH Slots when First RB Couple is On and when Detection is Manual.

This value sets the RB index of the selected user's PUCCH allocation for this slot. The next or previous (see Notes below) slot's PUCCH allocation will automatically be set according to the LTE standard (mirrored in frequency).

For example, in a 5 MHz LTE signal (25 RBs), when Slot 0 contains a PUCCH allocation at RB 0, Slot 1 will be set to have a PUCCH allocation at RB 24.

NOTE

A user can only have one RB allocated to PUCCH per slot.

When Detection is Auto and Sync Slot is odd, this parameter sets the RB index for the second slot in a PUCCH subframe, causing the previous (instead of the next) slot to contain a mirrored PUCCH allocation for the current user.

See also: [“Auto Detect First RB” on page 1056](#)

Key Path	Meas Setup, Chan Profile Setup, Edit User Mapping, PUCCH, First RB
----------	---

LTE Modulation Analysis Measurement
Meas Setup (Measurement Setup)

Mode	LTE, LTETDD
Remote Command	[:SENSe] :EVM:ULINk:PROFile:USER<n>:PUCCh:RB <integer> [:SENSe] :EVM:ULINk:PROFile:USER<n>:PUCCh:RB?
Example	EVM:ULIN:PROF:USER1:PUCCh:RB 0 EVM:ULIN:PROF:USER1:PUCCh:RB?
Notes	Changes to this parameter will not be applied until Update Changes command is sent. See “RB Parameter Manager (Uplink)” on page 1118 section for more details.
Dependencies	The range of sub op code <n> values is determined by the number of Users the user has configured. Max value for n = 50. If the user attempts to remotely set or query a sub op code that is out of range, this will result in an error message. Enabled when Detection is Manual, First RB Couple is ON, DMRS Params is OFF, and PUCCH Active is ON.
Couplings	Max value dependent on Bandwidth.
Preset	0
State Saved	Saved in instrument state.
Min	0
Max	5 – Bandwidth 1.4 MHz 14 – Bandwidth 3 MHz 24 – Bandwidth 5 MHz 49 – Bandwidth 10 MHz 74 – Bandwidth 15 MHz 99 – Bandwidth 20 MHz
Initial S/W Revision	Prior to A.02.00
Modified at S/W Revision	A.03.00

Auto Detect First RB

Sets the First Resource Block for all the PUCCH Slots when Detection is Auto.

Key Path	Meas Setup, Chan Profile Setup, Edit User Mapping, PUCCH, First RB
Mode	LTE, LTETDD
Remote Command	[:SENSe] :EVM:ULINk:PROFile:AUTO:PUCCh:RB <integer> [:SENSe] :EVM:ULINk:PROFile:AUTO:PUCCh:RB?
Example	EVM:ULIN:PROF:AUTO:PUCCh:RB 0 EVM:ULIN:PROF:AUTO:PUCCh:RB?

Notes	Changes to this parameter will not be applied until Update Changes command is sent. See “RB Parameter Manager (Uplink)” on page 1118 section for more details.
Dependencies	Enabled when Detection is Auto, First RB Couple is ON, Auto Detect DMRS Params is OFF, and Auto Detect PUCCH Active is ON.
Preset	0
State Saved	Saved in instrument state.
Min	0
Max	5 – Bandwidth 1.4 MHz 14 – Bandwidth 3 MHz 24 – Bandwidth 5 MHz 49 – Bandwidth 10 MHz 74 – Bandwidth 15 MHz 99 – Bandwidth 20 MHz
Initial S/W Revision	Prior to A.02.00
Modified at S/W Revision	A.03.00

First RB Couple

Determines whether or not all the PUCCH Slots will use the Common First RB value.

Key Path	Meas Setup, Chan Profile Setup, Edit User Mapping, PUCCH, Couple First RB
Mode	LTE, LTETDD
Remote Command	[:SENSE] :EVM:ULINK:PROF:USER<n>:PUCCh:RB:COUPle OFF ON 0 1 [:SENSE] :EVM:ULINK:PROF:USER<n>:PUCCh:RB:COUPle?
Example	EVM:ULIN:PROF:USER1:PUCc:RB:COUP ON EVM:ULIN:PROF:USER1:PUCc:RB:COUP?
Notes	Changes to this parameter will not be applied until Update Changes command is sent. See “RB Parameter Manager (Uplink)” on page 1118 section for more details.
Dependencies	The range of sub op code <n> values is determined by the number of Users the user has configured. Max value for n = 50. If the user attempts to remotely set or query a sub op code that is out of range, this will result in an error message. Enabled when Detection is Manual, DMRS Params is OFF, and PUCCH Active is ON.
Preset	ON

LTE Modulation Analysis Measurement
Meas Setup (Measurement Setup)

State Saved	Saved in instrument state.
Initial S/W Revision	Prior to A.02.00
Modified at S/W Revision	A.03.00

Common Format

Selects the PUCCH Format type for all the PUCCH Slots when Format Couple is On.

Key Path	Meas Setup, Chan Profile Setup, Edit User Mapping, PUCCH, Format
Mode	LTE, LTETDD
Remote Command	[:SENSE] :EVM:ULINK:PROFfile:USER<n>:PUCCh:FORMat T1 T1A T1B T2 T2A T2B T1S T1AS T1BS [:SENSE] :EVM:ULINK:PROFfile:USER<n>:PUCCh:FORMat?
Example	EVM:ULIN:PROF:USER1:PUCCh:FORM T1 EVM:ULIN:PROF:USER1:PUCCh:FORM?
Notes	Changes to this parameter will not be applied until Update Changes command is sent. See “RB Parameter Manager (Uplink)” on page 1118 section for more details.
Dependencies	The range of sub op code <n> values is determined by the number of Users the user has configured. Max value for n = 50. If the user attempts to remotely set or query a sub op code that is out of range, this will result in an error message. Enabled when Detection is Auto and Format Couple is ON, and PUCCH Active is ON.
Preset	T1
State Saved	Saved in instrument state.
Range	Type 1 Type 1a Type 1b Type 2 Type 2a Type 2b Type 1 Short Type 1a Short Type 1b Short
Initial S/W Revision	Prior to A.02.00
Modified at S/W Revision	A.03.00

Auto Detect Format

Selects the PUCCH Format type for all the PUCCH Slots when Detection is Auto.

Key Path	Meas Setup, Chan Profile Setup, Edit User Mapping, PUCCH, Format
Mode	LTE, LTETDD
Remote Command	[:SENSE] :EVM:ULINK:PROFfile:AUTO:PUCCh:FORMat T1 T1A T1B T2 T2A T2B T1S T1AS T1BS [:SENSE] :EVM:ULINK:PROFfile:AUTO:PUCCh:FORMat?

Example	EVM:ULIN:PROF:AUTO:PUCCH:FORM T1 EVM:ULIN:PROF:AUTO:PUCCH:FORM?
Notes	Changes to this parameter will not be applied until Update Changes command is sent. See “RB Parameter Manager (Uplink)” on page 1118 section for more details.
Dependencies	Enabled when Detection is Auto and Auto Detect PUCCH Active is ON.
Preset	T1
State Saved	Saved in instrument state.
Range	Type 1 Type 1a Type 1b Type 2 Type 2a Type 2b Type 1 Short Type 1a Short Type 1b Short
Initial S/W Revision	Prior to A.02.00
Modified at S/W Revision	A.03.00

Type 1

Selects Type 1 for the Format type for all the PUCCH Slots when Format Couple is On.

Key Path	Meas Setup, Chan Profile Setup, Edit User Mapping, PUCCH, Format
Mode	LTE, LTETDD
Initial S/W Revision	Prior to A.02.00
Modified at S/W Revision	A.03.00

Type 1a

Selects Type 1a for the Format type for all the PUCCH Slots when Format Couple is On.

Key Path	Meas Setup, Chan Profile Setup, Edit User Mapping, PUCCH, Format
Mode	LTE, LTETDD
Initial S/W Revision	Prior to A.02.00
Modified at S/W Revision	A.03.00

Type 1b

Selects Type 1b for the Format type for all the PUCCH Slots when Format Couple is On and when Detection is Manual.

Key Path	Meas Setup, Chan Profile Setup, Edit User Mapping, PUCCH, Format
Mode	LTE, LTETDD
Initial S/W Revision	Prior to A.02.00
Modified at S/W Revision	A.03.00

LTE Modulation Analysis Measurement
Meas Setup (Measurement Setup)

Type 2

Selects Type 2 for the Format type for all the PUCCH Slots when Format Couple is On.

Key Path	Meas Setup, Chan Profile Setup, Edit User Mapping, PUCCH, Format
Mode	LTE, LTETDD
Initial S/W Revision	Prior to A.02.00
Modified at S/W Revision	A.03.00

Type 2a

Selects Type 2a for the Format type for all the PUCCH Slots when Format Couple is On.

Key Path	Meas Setup, Chan Profile Setup, Edit User Mapping, PUCCH, Format
Mode	LTE, LTETDD
Initial S/W Revision	Prior to A.02.00
Modified at S/W Revision	A.03.00

Type 2b

Selects Type 2b for the Format type for all the PUCCH Slots when Format Couple is On.

Key Path	Meas Setup, Chan Profile Setup, Edit User Mapping, PUCCH, Format
Mode	LTE, LTETDD
Initial S/W Revision	Prior to A.02.00
Modified at S/W Revision	A.03.00

Type 1 Short

Selects Type 1 Short for the Format type for all the PUCCH Slots when Format Couple is On.

Key Path	Meas Setup, Chan Profile Setup, Edit User Mapping, PUCCH, Format
Mode	LTE LTETDD
Initial S/W Revision	A.03.00

Type 1a Short

Selects Type 1a Short for the Format type for all the PUCCH Slots when Format Couple is On.

Key Path	Meas Setup, Chan Profile Setup, Edit User Mapping, PUCCH, Format
Mode	LTE LTETDD
Initial S/W Revision	A.03.00

Type 1b Short

Selects Type 1b Short for the Format type for all the PUCCH Slots when Format Couple is On.

Key Path	Meas Setup, Chan Profile Setup, Edit User Mapping, PUCCH, Format
Mode	LTE LTETDD
Initial S/W Revision	A.03.00

Common Format Couple

Determines whether or not all the PUCCH Slots will use the Common Format value.

Key Path	Meas Setup, Chan Profile Setup, Edit User Mapping, PUCCH, Format
Mode	LTE, LTETDD
Remote Command	[:SENSE] :EVM:ULINK:PROFile:USER<n>:PUCCh:FORMat:COUPle OFF ON 0 1 [:SENSE] :EVM:ULINK:PROFile:USER<n>:PUCCh:FORMat:COUPle?
Example	EVM:ULIN:PROF:USER1:PUCc:FORM:COUP ON EVM:ULIN:PROF:USER1:PUCc:FORM:COUP?
Notes	Changes to this parameter will not be applied until Update Changes command is sent. See “RB Parameter Manager (Uplink)” on page 1118 section for more details.
Dependencies	The range of sub op code <n> values is determined by the number of Users the user has configured. Max value for n = 50. If the user attempts to remotely set or query a sub op code that is out of range, this will result in an error message. Enabled when Detection is Manual and PUCCH Active is ON.
Preset	ON
State Saved	Saved in instrument state.
Initial S/W Revision	Prior to A.02.00
Modified at S/W Revision	A.03.00

Common Cyclic Shift

Sets PUCCH cyclic shift.

Key Path	Meas Setup, Chan Profile Setup, Edit User Mapping, PUCCH
----------	---

Common Cyclic Shift

Sets the Cyclic Shift for all the PUCCH Slots when Cyclic Shift Couple is On and Auto Detect is Off.

Key Path	Meas Setup, Chan Profile Setup, Edit User Mapping, PUCCH, Cyclic Shift
----------	---

LTE Modulation Analysis Measurement
Meas Setup (Measurement Setup)

Mode	LTE, LTETDD
Remote Command	[:SENSe]:EVM:ULINk:PROFile:USER<n>:PUCCh:CSHift <integer> [:SENSe]:EVM:ULINk:PROFile:USER<n>:PUCCh:CSHift?
Example	EVM:ULIN:PROF:USER1:PUCc:CSH 1 EVM:ULIN:PROF:USER1:PUCc:CSH
Notes	Changes to this parameter will not be applied until Update Changes command is sent. See “RB Parameter Manager (Uplink)” on page 1118 section for more details.
Dependencies	The range of sub op code <n> values is determined by the number of Users the user has configured. Max value for n = 50. If the user attempts to remotely set or query a sub op code that is out of range, this will result in an error message. Enabled when Detection is Manual, Cyclic Shift Couple is ON, DMRS Params is OFF, and PUCCH Active is ON.
Preset	0
State Saved	Saved in instrument state.
Min	0
Max	11
Initial S/W Revision	Prior to A.02.00
Modified at S/W Revision	A.03.00

Auto Detect Cyclic Shift

Sets the Cyclic Shift for all the PUCCH Slots when Detection is Auto.

Key Path	Meas Setup, Chan Profile Setup, Edit User Mapping, PUCCH, Cyclic Shift
Mode	LTE, LTETDD
Remote Command	[:SENSe]:EVM:ULINk:PROFile:AUTO:PUCCh:CSHift <integer> [:SENSe]:EVM:ULINk:PROFile:AUTO:PUCCh:CSHift?
Example	EVM:ULIN:PROF:AUTO:PUCc:CSH 1 EVM:ULIN:PROF:AUTO:PUCc:CSH?
Notes	Changes to this parameter will not be applied until Update Changes command is sent. See “RB Parameter Manager (Uplink)” on page 1118 section for more details. Enabled when Detection is Auto, Auto Detect DMRS Params is OFF and Auto Detect PUCCH Active is ON.
Preset	0

State Saved	Saved in instrument state.
Min	0
Max	11
Initial S/W Revision	Prior to A.02.00
Modified at S/W Revision	A.03.00

Cyclic Shift Couple

Determines whether or not all the PUCCH Slots will use the Common Cyclic Shift value.

Key Path	Meas Setup, Chan Profile Setup, Edit User Mapping, PUCCH, Cyclic Shift
Mode	LTE, LTETDD
Remote Command	[:SENSE] :EVM:ULINK:PROfile:USER<n>:PUCCh:CSHift:COUple OFF ON 0 1 [:SENSE] :EVM:ULINK:PROfile:USER<n>:PUCCh:CSHift:COUple?
Example	EVM:ULIN:PROF:USER1:PUCc:CSH:COUP ON EVM:ULIN:PROF:USER1:PUCc:CSH:COUP?
Notes	Changes to this parameter will not be applied until Update Changes command is sent. See “RB Parameter Manager (Uplink)” on page 1118 section for more details.
Dependencies	The range of sub op code <n> values is determined by the number of Users the user has configured. Max value for n = 50. If the user attempts to remotely set or query a sub op code that is out of range, this will result in an error message. Enabled when Detection is Manual, DMRS Params is OFF, and PUCCH Active is ON.
Preset	ON
State Saved	Saved in instrument state.
Initial S/W Revision	Prior to A.02.00
Modified at S/W Revision	A.03.00

Common OS

Sets the Orthogonal Sequence index for all the PUCCH Slots when OS Couple is On and Detection is Auto.

Key Path	Meas Setup, Chan Profile Setup, Edit User Mapping, PUCCH, OS
Mode	LTE, LTETDD
Remote Command	[:SENSE] :EVM:ULINK:PROfile:USER<n>:PUCCh:OS INDex0 INDex1 INDex2 [:SENSE] :EVM:ULINK:PROfile:USER<n>:PUCCh:OS?

LTE Modulation Analysis Measurement
Meas Setup (Measurement Setup)

Example	EVM:ULIN:PROF:USER1:PUC:OS IND0 EVM:ULIN:PROF:USER1:PUC:OS?
Notes	Changes to this parameter will not be applied until Update Changes command is sent. See “RB Parameter Manager (Uplink)” on page 1118 section for more details.
Dependencies	The range of sub op code <n> values is determined by the number of Users the user has configured. Max value for n = 50. If the user attempts to remotely set or query a sub op code that is out of range, this will result in an error message. Enabled when all the following conditions are met. Detection is Manual, DMRS Params is OFF, OS Couple is ON, PUCCH Active is ON, and Format is not Type2, Type 2a, Type 2b.
Preset	IND0
State Saved	Saved in instrument state.
Range	Index 0 Index1 Index2
Initial S/W Revision	Prior to A.02.00
Modified at S/W Revision	A.03.00

Auto Detect OS

Sets the Orthogonal Sequence index for all the PUCCH Slots when Detection is Auto.

Key Path	Meas Setup, Chan Profile Setup, Edit User Mapping, PUCCH, OS
Mode	LTE, LTETDD
Remote Command	[:SENSe] :EVM:ULINk:PROFfile:AUTO:PUCCh:OS INDex0 INDex1 INDex2 [:SENSe] :EVM:ULINk:PROFfile:AUTO:PUCCh:OS?
Example	EVM:ULIN:PROF:AUTO:PUC:OS IND0 EVM:ULIN:PROF:AUTO:PUC:OS?
Notes	Changes to this parameter will not be applied until Update Changes command is sent. See “RB Parameter Manager (Uplink)” on page 1118 section for more details.

Dependencies	Enabled when all the following conditions are met. Detection is Auto, Auto Detect DMRS Params is OFF, Auto Detect PUCCH Active is ON, and Auto Detect Format is not Type2, Type 2a, Type 2b.
Preset	IND0
State Saved	Saved in instrument state.
Range	Index 0 Index 1 Index2
Initial S/W Revision	Prior to A.02.00
Modified at S/W Revision	A.03.00

Index0

Selects Index0 for the OS for all the PUCCH Slots when OS Couple is On.

Key Path	Meas Setup, Chan Profile Setup, Edit User Mapping, PUCCH, OS
Mode	LTE, LTETDD
Initial S/W Revision	Prior to A.02.00
Modified at S/W Revision	A.03.00

Index1

Selects Index1 for the OS for all the PUCCH Slots when OS Couple is On.

Key Path	Meas Setup, Chan Profile Setup, Edit User Mapping, PUCCH, OS
Mode	LTE, LTETDD
Initial S/W Revision	Prior to A.02.00
Modified at S/W Revision	A.03.00

Index2

Selects Index2 for the OS for all the PUCCH Slots when OS Couple is On.

Key Path	Meas Setup, Chan Profile Setup, Edit User Mapping, PUCCH, OS
Mode	LTE, LTETDD
Initial S/W Revision	Prior to A.02.00
Modified at S/W Revision	A.03.00

LTE Modulation Analysis Measurement
Meas Setup (Measurement Setup)

OS Couple

Determines whether or not all the PUCCH Slots will use the Common OS value.

Key Path	Meas Setup, Chan Profile Setup, Edit User Mapping, PUCCH,OS
Mode	LTE, LTETDD
Remote Command	[:SENSe] :EVM:ULINk:PROFile:USER<n>:PUCCh:OS:COUPLe OFF ON 0 1 [:SENSe] :EVM:ULINk:PROFile:USER<n>:PUCCh:OS:COUPLe?
Example	EVM:ULIN:PROF:USER1:PUCCh:OS:COUP ON EVM:ULIN:PROF:USER1:PUCCh:OS:COUP?
Notes	Changes to this parameter will not be applied until Update Changes command is sent. See “ RB Parameter Manager (Uplink) ” on page 1118 section for more details.
Dependencies	The range of sub op code <n> values is determined by the number of Users the user has configured. Max value for n = 50. If the user attempts to remotely set or query a sub op code that is out of range, this will result in an error message. Enabled when Detection is Manual, DMRS Params is OFF, and PUCCH Active is ON. .
Preset	ON
State Saved	Saved in instrument state.
Initial S/W Revision	Prior to A.02.00
Modified at S/W Revision	A.03.00

Common Power

Sets the PUCCH average power level relative to the 0 dB point set by the PUCCH DMRS Power.

Key Path	Meas Setup, Chan Profile Setup, Edit User Mapping, PUCCH
----------	---

Common Power Boost

Sets the Power Boost value for all the PUCCH Slots when Power Boost Couple is On and Auto Detect is Off.

Power Boost specifies the average PUCCH DMRS power for a slot.

NOTE All channel and signal powers are relative to the 0 dB level determined by the power of the channel/signal chosen for synchronization.

Key Path	Meas Setup, Chan Profile Setup, Edit User Mapping, PUCCH, Couple Power Boost
----------	---

Mode	LTE, LTETDD
Remote Command	[:SENSe]:EVM:ULINK:PROFile:USER<n>:PUCCh:PWRBoost <rel_ampl> [:SENSe]:EVM:ULINK:PROFile:USER<n>:PUCCh:PWRBoost?
Example	EVM:ULIN:PROF:USER1:PUCc:PWRB 0 EVM:ULIN:PROF:USER1:PUCc:PWRB?
Notes	Changes to this parameter will not be applied until Update Changes command is sent. See “RB Parameter Manager (Uplink)” on page 1118 section for more details.
Dependencies	The range of sub op code <n> values is determined by the number of Users the user has configured. Max value for n = 50. If the user attempts to remotely set or query a sub op code that is out of range, this will result in an error message. Enabled when Power Boost Couple is On, Detection is Manual, and PUCCH Active is ON.
Preset	0 dB
State Saved	Saved in instrument state.
Min	-100 dB
Max	100 dB
Initial S/W Revision	Prior to A.02.00
Modified at S/W Revision	A.03.00, A.04.20

Auto Detect Power Boost

Sets the Power Boost value for all the PUCCH Slots when Detection is Auto.

Key Path	Meas Setup, Chan Profile Setup, Edit User Mapping, PUCCH, Couple Power Boost
Mode	LTE, LTETDD
Remote Command	[:SENSe]:EVM:ULINK:PROFile:AUTO:PUCCh:PWRBoost <rel_ampl> [:SENSe]:EVM:ULINK:PROFile:AUTO:PUCCh:PWRBoost?
Example	EVM:ULIN:PROF:AUTO:PUCc:PWRB 0 EVM:ULIN:PROF:AUTO:PUCc:PWRB?
Notes	Changes to this parameter will not be applied until Update Changes command is sent. See “RB Parameter Manager (Uplink)” on page 1118 section for more details.
Dependencies	Enabled when Detection is Auto and Auto Detect PUCCH Active is ON.

LTE Modulation Analysis Measurement
Meas Setup (Measurement Setup)

Preset	0 dB
State Saved	Saved in instrument state.
Min	-100 dB
Max	100 dB
Initial S/W Revision	Prior to A.02.00
Modified at S/W Revision	A.03.00, A.04.20

Power Boost Couple

Determines whether or not all the PUCCH Slots will use the Common Power Boost value.

Key Path	Meas Setup, Chan Profile Setup, Edit User Mapping, PUCCH, Power Boost
Mode	LTE, LTETDD
Remote Command	[:SENSe] :EVM:ULINk:PROFile:USER<n>:PUCCh:PWRBoost:COUPl e OFF ON 0 1 [:SENSe] :EVM:ULINk:PROFile:USER<n>:PUCCh:PWRBoost:COUPl e?
Example	EVM:ULIN:PROF:USER1:PUCC:PWRB:COUP ON EVM:ULIN:PROF:USER1:PUCC:PWRB:COUP?
Notes	Changes to this parameter will not be applied until Update Changes command is sent. See “RB Parameter Manager (Uplink)” on page 1118 section for more details.
Dependencies	The range of sub op code <n> values is determined by the number of Users the user has configured. Max value for n = 50. If the user attempts to remotely set or query a sub op code that is out of range, this will result in an error message. Enabled when Detection is Manual, and PUCCH Active is ON.
Preset	ON
State Saved	Saved in instrument state.
Initial S/W Revision	Prior to A.02.00
Modified at S/W Revision	A.03.00

Common DMRS Group

Sets the group number for the PUCCH demodulation reference signal (DMRS) when DMRS Group Couple is On and Detection is Manual.

Key Path	Meas Setup, Chan Profile Setup, Edit User Mapping, PUCCH, DMRS Group
----------	---

Mode	LTE, LTETDD
Remote Command	[:SENSE] :EVM:ULINK:PROF:USER<n>:PUCCh:DMRS:GROup <integer> [:SENSe] :EVM:ULINK:PROF:USER<n>:PUCCh:DMRS:GROup?
Example	EVM:ULIN:PROF:USER1:PUCc:DMRS:GRO 1 EVM:ULIN:PROF:USER1:PUCc:DMRS:GRO?
Notes	Changes to this parameter will not be applied until Update Changes command is sent. See “RB Parameter Manager (Uplink)” on page 1118 section for more details.
Dependencies	The range of sub op code <n> values is determined by the number of Users the user has configured. Max value for n = 50. If the user attempts to remotely set or query a sub op code that is out of range, this will result in an error message. Enabled when Detection is Manual, DMRS Group Couple is ON, DMRS Params is OFF, and PUCCH Active is ON.
Preset	0
State Saved	Saved in instrument state.
Min	0
Max	29
Initial S/W Revision	Prior to A.02.00
Modified at S/W Revision	A.03.00

Auto Detect DMRS Group

Sets the group number for the PUCCH demodulation reference signal (DMRS) when Detection is Auto.

Key Path	Meas Setup, Chan Profile Setup, Edit User Mapping, PUCCH, DMRS Group
Mode	LTE, LTETDD
Remote Command	[:SENSE] :EVM:ULINK:PROF:AUTO:PUCCh:DMRS:GROup <integer> [:SENSe] :EVM:ULINK:PROF:AUTO:PUCCh:DMRS:GROup?
Example	EVM:ULIN:PROF:AUTO:PUCc:DMRS:GRO 1 EVM:ULIN:PROF:AUTO:PUCc:DMRS:GRO?
Notes	Changes to this parameter will not be applied until Update Changes command is sent. See “RB Parameter Manager (Uplink)” on page 1118 section for more details.
Dependencies	Enabled when Detection is Auto, Auto Detect DMRS Params is OFF, and Auto Detect PUCCH Active is ON.

LTE Modulation Analysis Measurement
Meas Setup (Measurement Setup)

Preset	0
State Saved	Saved in instrument state.
Min	0
Max	29
Initial S/W Revision	Prior to A.02.00
Modified at S/W Revision	A.03.00

DMRS Group Couple

Determines whether or not all the PUCCH Slots will use the DMRS Group All value.

Key Path	Meas Setup, Chan Profile Setup, Edit User Mapping, PUCCH,DMRS Group
Mode	LTE, LTETDD
Remote Command	[:SENSe] :EVM:ULINk:PROFile:USER<n>:PUCCh:DMRS:GROup:COU Ple OFF ON 0 1 [:SENSe] :EVM:ULINk:PROFile:USER<n>:PUCCh:DMRS:GROup:COU Ple?
Example	EVM:ULIN:PROF:USER1:PUCCh:DMRS:GRO:COUP ON EVM:ULIN:PROF:USER1:PUCCh:DMRS:GRO:COUP?
Notes	Changes to this parameter will not be applied until Update Changes command is sent. See “RB Parameter Manager (Uplink)” on page 1118 section for more details.
Dependencies	The range of sub op code <n> values is determined by the number of Users the user has configured. Max value for n = 50. If the user attempts to remotely set or query a sub op code that is out of range, this will result in an error message. Enabled when Detection is Manual, DMRS Params is OFF and PUCCH Active is ON.
Preset	ON
State Saved	Saved in instrument state.
Initial S/W Revision	Prior to A.02.00
Modified at S/W Revision	A.03.00

Common DMRS Power

Sets the power level for the PUCCH demodulation reference signal (DMRS) during the selected subframe.

Key Path	Meas Setup, Chan Profile Setup, Edit User Mapping, PUCCH
----------	---

Common DMRS Power Boost

Sets the DMRS Power Boost value for all the PUCCH Slots when DMRS Power Boost Couple is On and Detection is Manual.

This value sets the power level for the PUCCH demodulation reference signal (DMRS) of the selected subframe. PUCCH Power is set relative to the 0 dB point determined by this parameter.

For example, setting DMRS Power = 2 dB and PUCCH Power = 0.1 dB means that the demodulator will expect PUCCH average power level to be 1.9 dB below the average DMRS power level.

Key Path	Meas Setup, Chan Profile Setup, Edit User Mapping, PUCCH, Couple DMRS Power Boost
Mode	LTE, LTETDD
Remote Command	[:SENSe] :EVM:ULINk:PROFile:USER<n>:PUCCh:DMRS:PWRBoost <rel_ampl> [:SENSe] :EVM:ULINk:PROFile:USER<n>:PUCCh:DMRS:PWRBoost?
Example	EVM:ULIN:PROF:USER1:PUCc:PWRB 0 EVM:ULIN:PROF:USER1:PUCc:PWRB?
Notes	Changes to this parameter will not be applied until Update Changes command is sent. See “RB Parameter Manager (Uplink)” on page 1118 section for more details.
Dependencies	The range of sub op code <n> values is determined by the number of Users the user has configured. Max value for n = 50. If the user attempts to remotely set or query a sub op code that is out of range, this will result in an error message. Enabled when DMRS Power Boost Couple is On, Detection is Manual, and PUCCH Active is ON.
Preset	0 dB
State Saved	Saved in instrument state.
Min	-100 dB
Max	100 dB
Initial S/W Revision	Prior to A.02.00
Modified at S/W Revision	A.03.00
Modified at S/W Revision	A.04.20

Auto Detect DMRS Power Boost

Sets the DMRS Power Boost value for all the PUCCH Slots when Detection is Auto.

Key Path	Meas Setup, Chan Profile Setup, Edit User Mapping, PUCCH, Couple DMRS Power Boost
Mode	LTE, LTETDD

LTE Modulation Analysis Measurement
Meas Setup (Measurement Setup)

Remote Command	[:SENSe] :EVM:ULINk:PROFile:AUTO:PUCCh:DMRS:PWRBoost <rel_ampl> [:SENSe] :EVM:ULINk:PROFile:AUTO:PUCCh:DMRS:PWRBoost?
Example	EVM:ULIN:PROF:AUTO:PUC:PW RB 0 EVM:ULIN:PROF:AUTO:PUC:PW RB?
Notes	Changes to this parameter will not be applied until Update Changes command is sent. See “ RB Parameter Manager (Uplink) ” on page 1118 section for more details.
Dependencies	Enabled when Detection is Auto and Auto Detect PUCCH Active is ON.
Preset	0 dB
State Saved	Saved in instrument state.
Min	-100 dB
Max	100 dB
Initial S/W Revision	Prior to A.02.00
Modified at S/W Revision	A.03.00, A.04.20

DMRS Power Boost Couple

Determines whether or not all the PUCCH Slots will use the Common DMRS Power Boost value.

Key Path	Meas Setup, Chan Profile Setup, Edit User Mapping, PUCCH, DMRS Power Boost
Mode	LTE, LTETDD
Remote Command	[:SENSe] :EVM:ULINk:PROFile:USER<n>:PUCCh:DMRS:PWRBoost : COUPle OFF ON 0 1 [:SENSe] :EVM:ULINk:PROFile:USER<n>:PUCCh:DMRS:PWRBoost : COUPle?
Example	EVM:ULIN:PROF:USER1:PUC:DMRS:PW RB:COUP ON EVM:ULIN:PROF:USER1:PUC:DMRS:PW RB:COUP?
Notes	Changes to this parameter will not be applied until Update Changes command is sent. See “ RB Parameter Manager (Uplink) ” on page 1118 section for more details.
Dependencies	The range of sub op code <n> values is determined by the number of Users the user has configured. Max value for n = 50. If the user attempts to remotely set or query a sub op code that is out of range, this will result in an error message. Enabled when Detection is Manual and PUCCH Active is ON.
Preset	ON
State Saved	Saved in instrument state.

Initial S/W Revision	Prior to A.02.00
Modified at S/W Revision	A.03.00

Common N PUCCH (1)

Key Path	Meas Setup, Chan Profile Setup, Edit User Mapping, PUCCH
----------	---

Common N PUCCH (1)

Sets the $n_{\text{PUCCH}}(1)$ for all PUCCH Slots when Detection is Manual.

Key Path	Meas Setup, Chan Profile Setup, Edit User Mapping, PUCCH, N PUCCH (1)
Mode	LTE, LTETDD
Remote Command	[:SENSe] :EVM:ULINk:PROfile:USER<n>:PUCCh:N:ONE <integer> [:SENSe] :EVM:ULINk:PROfile:USER<n>:PUCCh:N:ONE?
Example	EVM:ULIN:PROF:USER1:PUCCh:N:ONE 1 EVM:ULIN:PROF:USER1:PUCCh:N:ONE?
Notes	Changes to this parameter will not be applied until Update Changes command is sent. See “RB Parameter Manager (Uplink)” on page 1118 section for more details.
Dependencies	The range of sub op code <n> values is determined by the number of Users the user has configured. If the user attempts to remotely set or query a sub op code that is out of range, this will result in an error message. Enabled when Detection is Manual, DMRS Params is On, and PUCCH Active is ON.
Couplings	$n_{\text{PUCCH}}(1)$ should always be less than the total available subcarrier number of current bandwidth selection.
Preset	0
State Saved	Saved in instrument state.
Min	0
Max	1199
Initial S/W Revision	A.03.00
Modified at S/W Revision	A.06.00

LTE Modulation Analysis Measurement
Meas Setup (Measurement Setup)

Auto Detect N PUCCH (1)

Sets the $n_{\text{PUCCH}}(1)$ for all PUCCH Slots when Detection is Auto.

Key Path	Meas Setup, Chan Profile Setup, Edit User Mapping, PUCCH, N PUCCH (1)
Mode	LTE, LTETDD
Remote Command	[:SENSe] :EVM:ULINK:PROFile:AUTO:PUCCh:N:ONE <integer> [:SENSe] :EVM:ULINK:PROFile:AUTO:PUCCh:N:ONE?
Example	EVM:ULIN:PROF:AUTO:PUCCh:N:ONE 1 EVM:ULIN:PROF:AUTO:PUCCh:N:ONE?
Notes	Changes to this parameter will not be applied until Update Changes command is sent. See “ RB Parameter Manager (Uplink) ” on page 1118 section for more details.
Dependencies	If the user attempts to remotely set or query a sub op code that is out of range, this will result in an error message. Enabled when Detection is Auto, Auto Detect PUCCH DMRS Params is On, and Auto Detect PUCCH Active is ON.
Couplings	$n_{\text{PUCCH}}(1)$ should always be less than the total available subcarrier number of current bandwidth selection.
Preset	0
State Saved	Saved in instrument state.
Min	0
Max	1199
Initial S/W Revision	A.03.00
Modified at S/W Revision	A.06.00

N PUCCH (1) Couple

Determines whether or not all the PUCCH Slots will use the Common N PUCCH (1) value.

Key Path	Meas Setup, Chan Profile Setup, Edit User Mapping, PUCCH
Mode	LTE, LTETDD
Remote Command	[:SENSe] :EVM:ULINK:PROFile:USER<n>:PUCCh:N:ONE:COUple OFF ON 0 1 [:SENSe] :EVM:ULINK:PROFile:USER<n>:PUCCh:N:ONE:COUple?
Example	EVM:ULIN:PROF:USER1:PUCC:N:ONE:COUP ON EVM:ULIN:PROF:USER1:PUCC:N:ONE:COUP?

Notes	Changes to this parameter will not be applied until Update Changes command is sent. See RB Parameter Manager (Uplink) section for more details.
Dependencies	The range of sub op code <n> values is determined by the number of Users the user has configured. Max value for n = 50. If the user attempts to remotely set or query a sub op code that is out of range, this will result in an error message. Enabled when Detection is Manual, PUCCH Active is ON and PUCCH DMRS Params is ON.
Preset	ON
State Saved	Saved in instrument state.
Initial S/W Revision	A.06.00

PUCCH Slot Parameters

Sets all RB allocation for each slot.

Key Path	Meas Setup, Chan Profile Setup, Edit User Mapping, PUCCH
----------	---

Slot First RB

Sets the First Resource Block for the selected PUCCH slot allocation. Note that you can only set the first RB on even numbered slot allocations. The RB for the paired odd allocations are automatically set according to the constraints set by the LTE standard.

Key Path	Meas Setup, Chan Profile Setup, Edit User Mapping, PUCCH, RB
Mode	LTE, LTETDD
Remote Command	[:SENSe] :EVM:ULINk:PROFile:USER<n>:PUCCh:SLOT<m>:RB <integer> [:SENSe] :EVM:ULINk:PROFile:USER<n>:PUCCh:SLOT<m>:RB?
Example	EVM:ULIN:PROF:USER1:PUCCh:SLOT0:RB 0 EVM:ULIN:PROF:USER1:PUCCh:SLOT0:RB?
Notes	The index <m> in the above SCPI command is the allocation index, not the slot position. See the “Add PUCCH Slot” on page 1084 PUCCH Slot command for an explanation of the difference. Changes to this parameter will not be applied until Update Changes command is sent. See “RB Parameter Manager (Uplink)” on page 1118 section for more details.

LTE Modulation Analysis Measurement
Meas Setup (Measurement Setup)

Dependencies	<p>The range of sub op code <n> values is determined by the number of Users the user has configured. The range of sub op code <m> values is determined by the number of Slots the user has configured. Max value for n= 50. The range of sub op code <m> values is 0 – 19.</p> <p>If the user attempts to set the RB for an odd numbered slot, the command returns an error. However, odd slots may be queried.</p> <p>If the user attempts to remotely set or query a sub op code that is out of range, this will result in an error message.</p> <p>Disabled when the slot is odd indexed.</p> <p>Enabled when First RB Couple is OFF, PUCCH DMRS Params is Off, and PUCCH Active is ON.</p>
Couplings	Max value dependent on Bandwidth.
Preset	0
State Saved	Saved in instrument state.
Min	0
Max	<p>5 – Bandwidth 1.4 MHz</p> <p>14 – Bandwidth 3 MHz</p> <p>24 – Bandwidth 5 MHz</p> <p>49 – Bandwidth 10 MHz</p> <p>74 – Bandwidth 15 MHz</p> <p>99 – Bandwidth 20 MHz</p>
Initial S/W Revision	Prior to A.02.00
Modified at S/W Revision	A.03.00

Slot Format

Selects the PUCCH Format type to be used for the selected PUCCH Slot.

Key Path	Meas Setup, Chan Profile Setup, Edit User Mapping, PUCCH, Format
Mode	LTE, LTETDD
Remote Command	<p>[:SENSe] :EVM:ULINk:PROFile:USER<n>:PUCCh:SLOT<m>:FORMat T1 T1A T1B T2 T2A T2B T1S T1AS T1BS</p> <p>[:SENSe] :EVM:ULINk:PROFile:USER<n>:PUCCh:SLOT<m>:FORMat ?</p>
Example	<p>EVM:ULIN:PROF:USER1:PUCCh:SLOT0:FORMAT T1</p> <p>EVM:ULIN:PROF:USER1:PUCCh:SLOT0:FORMAT?</p>

Notes	<p>The index <m> in the above SCPI command is the allocation index, not the slot position. See the “Add PUCCH Slot” on page 1084 PUCCH Slot command for an explanation of the difference.</p> <p>Changes to this parameter will not be applied until Update Changes command is sent. See “RB Parameter Manager (Uplink)” on page 1118 section for more details.</p>
Dependencies	<p>The range of sub op code <n> values is determined by the number of Users the user has configured. The range of sub op code <m> values is determined by the number of Slots the user has configured. . Max value for n=50. The range of sub op code <m> values is 0 – 19.</p> <p>If the user attempts to remotely set or query a sub op code that is out of range, this will result in an error message.</p> <p>Enabled when Format Couple is OFF.</p>
Preset	T1
State Saved	Saved in instrument state.
Range	Type 1 Type 1a Type 1b Type 2 Type 2a Type 2b Type 1 Short Type 1a Short Type 1b Short
Initial S/W Revision	Prior to A.02.00
Modified at S/W Revision	A.03.00

Type 1

Selects Type 1 for the Format type for the selected PUCCH Slot.

Key Path	Meas Setup, Chan Profile Setup, Edit User Mapping, PUCCH, Format
Mode	LTE, LTETDD
Initial S/W Revision	Prior to A.02.00
Modified at S/W Revision	A.03.00

Type 1a

Selects Type 1a for the Format type for the selected PUCCH Slot.

Key Path	Meas Setup, Chan Profile Setup, Edit User Mapping, PUCCH, Format
Mode	LTE, LTETDD
Initial S/W Revision	Prior to A.02.00
Modified at S/W Revision	A.03.00

Type 1b

Selects Type 1b for the Format type for the selected PUCCH Slot.

Key Path	Meas Setup, Chan Profile Setup, Edit User Mapping, PUCCH, Format
----------	---

LTE Modulation Analysis Measurement
Meas Setup (Measurement Setup)

Mode	LTE, LTETDD
Initial S/W Revision	Prior to A.02.00
Modified at S/W Revision	A.03.00

Type 2

Selects Type 2 for the Format type for the selected PUCCH Slot.

Key Path	Meas Setup, Chan Profile Setup, Edit User Mapping, PUCCH, Format
Mode	LTE, LTETDD
Initial S/W Revision	Prior to A.02.00
Modified at S/W Revision	A.03.00

Type 2a

Selects Type 2a for the Format type for the selected PUCCH Slot.

Key Path	Meas Setup, Chan Profile Setup, Edit User Mapping, PUCCH, Format
Mode	LTE, LTETDD
Initial S/W Revision	Prior to A.02.00
Modified at S/W Revision	A.03.00

Type 2b

Selects Type 2b for the Format type for the selected PUCCH Slot.

Key Path	Meas Setup, Chan Profile Setup, Edit User Mapping, PUCCH, Format
Mode	LTE, LTETDD
Initial S/W Revision	Prior to A.02.00
Modified at S/W Revision	A.03.00

Type 1 Short

Selects Type 1 Short for the Format type for the selected PUCCH Slot.

Key Path	Meas Setup, Chan Profile Setup, Edit User Mapping, PUCCH, Format
Mode	LTE, LTETDD
Initial S/W Revision	A.03.00

Type 1a Short

Selects Type 1a Short for the Format type for the selected PUCCH Slot.

Key Path	Meas Setup, Chan Profile Setup, Edit User Mapping, PUCCH, Format
Mode	LTE, LTETDD
Initial S/W Revision	A.03.00

Type 1b Short

Selects Type 1b Short for the Format type for the selected PUCCH Slot.

Key Path	Meas Setup, Chan Profile Setup, Edit User Mapping, PUCCH, Format
Mode	LTE, LTETDD
Initial S/W Revision	A.03.00

Slot Cyclic Shift

Sets the Cyclic Shift for the selected PUCCH Slot.

Key Path	Meas Setup, Chan Profile Setup, Edit User Mapping, PUCCH, Cyclic Shift
Mode	LTE, LTETDD
Remote Command	[:SENSE] :EVM:ULINK:PROFile:USER<n>:PUCCh:SLOT<m>:CSHift <integer> [:SENSE] :EVM:ULINK:PROFile:USER<n>:PUCCh:SLOT<m>:CSHift ?
Example	EVM:ULIN:PROF:USER1:PUCc:SLOT0:CSH 1 EVM:ULIN:PROF:USER1:PUCc:SLOT0:CSH?
Notes	The index <m> in the above SCPI command is the allocation index, not the slot position. See the “Add PUCCH Slot” on page 1084 PUCCH Slot command for an explanation of the difference. Changes to this parameter will not be applied until Update Changes command is sent. See “RB Parameter Manager (Uplink)” on page 1118 section for more details.
Dependencies	The range of sub op code <n> values is determined by the number of Users the user has configured. The range of sub op code <m> values is determined by the number of Slots the user has configured. . Max value for n=50. The range of sub op code <m> values is 0 – 19. If the user attempts to remotely set or query a sub op code that is out of range, this will result in an error message. Enabled when Cyclic Shift Couple is OFF, PUCCh DMRS Params is OFF and PUCCH Active is ON
Preset	0

LTE Modulation Analysis Measurement
Meas Setup (Measurement Setup)

State Saved	Saved in instrument state.
Min	0
Max	11
Initial S/W Revision	Prior to A.02.00
Modified at S/W Revision	A.03.00

Slot OS

Sets the Orthogonal Sequence index for the selected PUCCH Slot.

Key Path	Meas Setup, Chan Profile Setup, Edit User Mapping, PUCCH, OS
Mode	LTE, LTETDD
Remote Command	[:SENSe] :EVM:ULINk:PROFile:USER<n>:PUCCh:SLOT<m>:OS INDEX0 INDEX1 INDEX2 [:SENSe] :EVM:ULINk:PROFile:USER<n>:PUCCh:SLOT<m>:OS?
Example	EVM:ULIN:PROF:USER1:PUCCh:SLOT0:OS IND0 EVM:ULIN:PROF:USER1:PUCCh:SLOT0:OS?
Notes	The index <m> in the above SCPI command is the allocation index, not the slot position. See the “Add PUCCH Slot” on page 1084 PUCCH Slot command for an explanation of the difference. Changes to this parameter will not be applied until Update Changes command is sent. See “RB Parameter Manager (Uplink)” on page 1118 section for more details.
Dependencies	The range of sub op code <n> values is determined by the number of Users the user has configured. Max value for n=50. The range of sub op code <m> values is 0 – 19. If the user attempts to remotely set or query a sub op code that is out of range, this will result in an error message. Enabled when all the following conditions are met. Either Format Couple is ON and Common Format is not Type 2, Type 2a, Type 2b or Format Couple is OFF and Slot Format of the same slot is not Type 2, Type 2a, Type 2b. OS Couple is OFF. and PUCCH Active is ON
Preset	IND0
State Saved	Saved in instrument state.
Range	Index 0 Index1 Index2
Initial S/W Revision	Prior to A.02.00
Modified at S/W Revision	A.03.00

Index0

Selects Index0 for the OS for the selected PUCCH Slot.

Key Path	Meas Setup, Chan Profile Setup, Edit User Mapping, PUCCH, OS
Mode	LTE, LTETDD
Initial S/W Revision	Prior to A.02.00
Modified at S/W Revision	A.03.00

Index1

Selects Index1 for the OS for the selected PUCCH Slot.

Key Path	Meas Setup, Chan Profile Setup, Edit User Mapping, PUCCH, OS
Mode	LTE, LTETDD
Initial S/W Revision	Prior to A.02.00
Modified at S/W Revision	A.03.00

Index2

Selects Index2 for the OS for the selected PUCCH Slot.

Key Path	Meas Setup, Chan Profile Setup, Edit User Mapping, PUCCH, OS
Mode	LTE, LTETDD
Initial S/W Revision	Prior to A.02.00
Modified at S/W Revision	A.03.00

Slot Power Boost

Sets the Power Boost value for the selected PUCCH Slot.

Key Path	Meas Setup, Chan Profile Setup, Edit User Mapping, PUCCH, Power Boost
Mode	LTE, LTETDD
Remote Command	[:SENSE]:EVM:ULINK:PROfile:USER<n>:PUCCh:SLOT<m>:PWRBoost <rel_ampl> [:SENSE]:EVM:ULINK:PROfile:USER<n>:PUCCh:SLOT<m>:PWRBoost?
Example	EVM:ULIN:PROF:USER1:PUCc:SLOT0:PWRB 0 EVM:ULIN:PROF:USER1:PUCc:SLOT0:PWRB?

LTE Modulation Analysis Measurement
Meas Setup (Measurement Setup)

Notes	<p>The index <m> in the above SCPI command is the allocation index, not the slot position. See the “Add PUCCH Slot” on page 1084 PUCCH Slot command for an explanation of the difference.</p> <p>Changes to this parameter will not be applied until Update Changes command is sent. See “RB Parameter Manager (Uplink)” on page 1118 section for more details.</p>
Dependencies	<p>The range of sub op code <n> values is determined by the number of Users the user has configured. The range of sub op code <m> values is determined by the number of Slots the user has configured. . Max value for n=50. The range of sub op code <m> values is 0 – 19.</p> <p>If the user attempts to remotely set or query a sub op code that is out of range, this will result in an error message.</p> <p>Enabled when Power Boost Couple is OFF and PUCCH Active is ON.</p>
Preset	0 dB
State Saved	Saved in instrument state.
Min	-100 dB
Max	100 dB
Initial S/W Revision	Prior to A.02.00
Modified at S/W Revision	A.03.00, A.04.20

Slot DMRS Group

Selects the DMRS Group for the selected PUCCH Slot.

Key Path	Meas Setup, Chan Profile Setup, Edit User Mapping, PUSCH,DMRS Group
Mode	LTE, LTETDD
Remote Command	<pre>[:SENSe] :EVM:ULINk:PROFile:USER<n>:PUCCh:SLOT<m>:DMRS:GROup <integer></pre> <pre>[:SENSe] :EVM:ULINk:PROFile:USER<n>:PUCCh:SLOT<m>:DMRS:GROup?</pre>
Example	<pre>EVM:ULIN:PROF:USER1:PUCCh:SLOT0:DMRS:GRO 1</pre> <pre>EVM:ULIN:PROF:USER1:PUCCh:SLOT0:DMRS:GRO?</pre>
Notes	<p>The index <m> in the above SCPI command is the allocation index, not the slot position. See the “Add PUCCH Slot” on page 1084 for an explanation of the difference.</p> <p>Changes to this parameter will not be applied until Update Changes command is sent. See “RB Parameter Manager (Uplink)” on page 1118 section for more details.</p>

Dependencies	<p>The range of sub op code <n> values is determined by the number of Users the user has configured. The range of sub op code <m> values is determined by the number of Slots the user has configured. Max value for n=50. The range of sub op code <m> values is 0 – 19.</p> <p>If the user attempts to remotely set or query a sub op code that is out of range, this will result in an error message.</p> <p>Enabled when DMRS Params is OFF, DMRS Group Couple is OFF and PUCCH Active is ON.</p>
Preset	0
State Saved	Saved in instrument state.
Min	0
Max	29
Initial S/W Revision	Prior to A.02.00
Modified at S/W Revision	A.03.00

Slot DMRS Power Boost

Sets the DMRS Power Boost value for the selected PUCCH Slot.

Key Path	Meas Setup, Chan Profile Setup, Edit User Mapping, PUCCH, DMRS Power Boost
Mode	LTE, LTETDD
Remote Command	<pre>[:SENSe] :EVM:ULINk:PROfile:USER<n>:PUCCh:SLOT<m>:DMRS:PWRBoost <rel_ampl></pre> <pre>[:SENSe] :EVM:ULINk:PROfile:USER<n>:PUCCh:SLOT<m>:DMRS:PWRBoost?</pre>
Example	<pre>EVM:ULIN:PROF:USER1:PUCCh:SLOT0:DMRS:PWRB 0</pre> <pre>EVM:ULIN:PROF:USER1:PUCCh:SLOT0:DMRS:PWRB?</pre>
Notes	<p>The index <m> in the above SCPI command is the allocation index, not the slot position. See the “Add PUCCH Slot” on page 1084 for an explanation of the difference.</p> <p>Changes to this parameter will not be applied until Update Changes command is sent. See “RB Parameter Manager (Uplink)” on page 1118 section for more details.</p>
Dependencies	<p>The range of sub op code <n> values is determined by the number of Users the user has configured. The range of sub op code <m> values is determined by the number of Slots the user has configured. . Max value for n=50. The range of sub op code <m> values is 0 – 19.</p> <p>If the user attempts to remotely set or query a sub op code that is out of range, this will result in an error message.</p> <p>Enabled when Power Boost Couple is OFF and PUCCH Active is ON.</p>

LTE Modulation Analysis Measurement
Meas Setup (Measurement Setup)

Preset	0 dB
State Saved	Saved in instrument state.
Min	-100 dB
Max	100 dB
Initial S/W Revision	Prior to A.02.00
Modified at S/W Revision	A.03.00, A.04.20

Slot N PUCCH (1)

Sets the N PUCCH (1) value for the selected PUCCH Slot.

Key Path	Meas Setup, Chan Profile Setup, Edit User Mapping, PUCCH
Mode	LTE, LTETDD
Remote Command	[:SENSe]:EVM:ULINk:PROFile:USER<n>:PUCCh:SLOT<m>:N:ONE <integer> [:SENSe]:EVM:ULINk:PROFile:USER<n>:PUCCh:SLOT<m>:N:ONE?
Example	EVM:ULIN:PROF:USER1:PUCCh:SLOT1:N:ONE 1 EVM:ULIN:PROF:USER1:PUCCh:SLOT1:N:ONE?
Notes	Changes to this parameter will not be applied until Update Changes command is sent. See RB Parameter Manager (Uplink) section for more details.
Dependencies	The range of sub op code <n> values is determined by the number of Users the user has configured. The range of sub op code <m> values is determined by the number of Slots the user has configured. . Max value for n=50. The range of sub op code <m> values is 0 – 19. If the user attempts to remotely set or query a sub op code that is out of range, this will result in an error message. Enabled when Detection is Manual, PUCCH Active is ON, PUCCH DMRS Params is ON and N PUCCH (1) Couple is OFF.
Couplings	$n_{PUCCH(1)}$ should be less than the total available subcarrier number of the current bandwidth selection.
Preset	0
State Saved	Saved in instrument state.
Min	0
Max	1199
Initial S/W Revision	A.06.00

Add PUCCH Slot

Adds a new PUCCH allocation pair. One of the allocations will be in the slot position specified, if available. The other will be in the slot immediately following if the parameter is even, or the slot immediately preceding if the

parameter is odd. The new allocations will have their parameters set to default values. They are put into a collection of allocations in ascending order of slot position. The allocation at the even numbered slot gets the lower index. The SCPI commands that follow are used to set slot allocation parameters, such as RB. They all contain the mnemonic SLOT<m>, where <m> is an index into the collection of allocations. The index ranges from 0 to a maximum of 19. Do not confuse the allocation index with the slot position.

To avoid confusion, you should make PUCCH allocations in ascending order of even slot positions.

For example, suppose you sent the following commands in order (and no previous allocations were made):

```
EVM:ULIN:PROF:USER1:PUCCH:ADD:SLOT 0
```

```
EVM:ULIN:PROF:USER1:PUCCH:ADD:SLOT 8
```

```
EVM:ULIN:PROF:USER1:PUCCH:ADD:SLOT 10
```

You now have six allocations. Allocation 0 is at slot position 0, allocation 1 is made automatically at slot position 1, allocations 2 and 3 are at slot positions 8 and 9, and allocations 4 and 5 at slot positions 10 and 11. The allocations are referenced as SLOT0, SLOT1, SLOT2, etc. in the commands that follow. For example, if you want to verify the slot position of the third allocation, send the following query:

```
EVM:ULIN:PROF:USER1:PUCCH:SLOT2:POS?
```

This will return 8 for this example, and the following query will return “9”s:

```
EVM:ULIN:PROF:USER1:PUCCH:SLOT3:POS?
```

Note that if you delete an allocation, its paired companion is deleted also. It is recommended that you only delete even indices. To continue the previous example, send the following command:

```
EVM:ULIN:PROF:USER1:PUCCH:SLOT2:DEL
```

This removes the allocations at slot positions 8 and 9. The allocations at slot positions 10 and 11 are now referenced as SLOT2 and SLOT3, where before they were referenced as SLOT4 and SLOT5.

Key Path	Meas Setup, Chan Profile Setup, Edit User Mapping, PUCCH, Slot
Mode	LTE, LTETDD
Remote Command	[:SENSe] :EVM:ULINK:PROfile:USER<n>:PUCCh:ADD:SLOT<integer>
Example	EVM:ULIN:PROF:USER1:PUCCH:ADD:SLOT 0
Notes	The softkey for this parameter is an Immediate Action key. The value that is passed in by the SCPI command enables you to specify the slot position. As PUCCH has subframes, adding a slot will add the slot specified, if available, and the second slot in the subframe.
Notes	Changes to this parameter will not be applied until Update Changes command is sent. See “RB Parameter Manager (Uplink)” on page 1118 section for more details.
Dependencies	The range of sub op code <n> values is determined by the number of Users the user has configured. If the user attempts to add a Slot to a User and the slot is already allocated an error message will be generated. Disabled once the number of Slots reaches to 20 (max).
Preset	0

LTE Modulation Analysis Measurement
Meas Setup (Measurement Setup)

State Saved	Saved in instrument state.
Min	0
Max	19
Initial S/W Revision	Prior to A.02.00
Modified at S/W Revision	A.03.00

Delete PUCCH Slot

Deletes the currently selected slot allocation and its paired slot allocation.

Key Path	Meas Setup, Chan Profile Setup, Edit User Mapping, PUCCH, Slot
Mode	LTE, LTETDD
Remote Command	[:SENSe] :EVM:ULINk:PROFile:USER<n>:PUCCh:SLOT<m>:DELete
Example	EVM:ULIN:PROF:USER1:PUCCh:SLOT0:DEL
Notes	The index <m> in the above SCPI command is the allocation index, not the slot position. See the “ Add PUCCH Slot ” on page 1084 for an explanation of the difference. Changes to this parameter will not be applied until Update Changes command is sent. See “ RB Parameter Manager (Uplink) ” on page 1118 section for more details.
Dependencies	Disabled when there is only one Slot. The range of sub op code <n> values is determined by the number of Users the user has configured. The range of sub op code <m> values is determined by the number of Slots the user has configured. . Max value for n=50. The range of sub op code <m> values is 0 – 19. If the user attempts to delete a Slot that does not exist, an error message will be generated.
Initial S/W Revision	Prior to A.02.00
Modified at S/W Revision	A.03.00

Move Up

Moves the currently selected Slot up.

See also “[Slot Position](#) ” on page 1087 query

Key Path	Meas Setup, Chan Profile Setup, Edit User Mapping, PUCCH, Slot
Mode	LTE, LTETDD
Dependencies	Disabled when there are no Slots defined or if the slot is at Slot19.
Initial S/W Revision	Prior to A.02.00
Modified at S/W Revision	A.03.00

Move Down

Moves the currently selected Slot down.

See also “Slot Position ” on page 1087 query.

Key Path	Meas Setup, Chan Profile Setup, Edit User Mapping, PUCCH, Slot
Mode	LTE, LTETDD
Dependencies	Disabled when there are no Slots defined or if the slot is at Slot0.
Initial S/W Revision	Prior to A.02.00
Modified at S/W Revision	A.03.00

Slot Position

Queries the PUCCH slot start position.

Key Path	SCPI Only
Mode	LTE, LTETDD
Remote Command	[:SENSe] :EVM:ULINk:PROFile:USER<n>:PUCCh:SLOT<m>:POSiti on?
Example	EVM:ULIN:PROF:USER1:PUCc:SLOT0:POS?
Dependencies	The range of sub op code <n> values is determined by the number of Users the user has configured. The range of sub op code <m> values is determined by the number of Slots the user has configured. . Max value for n=50. The range of sub op code <m> values is 0 – 19.
Preset	0
State Saved	Saved in instrument state.
Min	0
Max	19
Initial S/W Revision	Prior to A.02.00
Modified at S/W Revision	A.03.00

PRACH Parameters

Displays a menu that enables you to set PRACH channel parameters for signals.

Key Path	Meas Setup, Chan Profile Setup, Edit User Mapping, PRACH Parameters
Mode	LTE, LTETDD
Initial S/W Revision	Prior to A.02.00
Modified at S/W Revision	A.03.00

LTE Modulation Analysis Measurement
Meas Setup (Measurement Setup)

PRACH Active

Selects whether or not PRACH exists in the input signal when Detection is Manual.

Key Path	Meas Setup, Chan Profile Setup, Edit User Mapping
Mode	LTE, LTETDD
Remote Command	[:SENSe] :EVM:ULINk:PROFile:USER1 50:PRACH:ACTive OFF ON 0 1 [:SENSe] :EVM:ULINk:PROFile:USER1 50:PRACH:ACTive?
Example	EVM:ULIN:PROF:USER1:PRAC:ACT OFF EVM:ULIN:PROF:USER1:PRAC:ACT?
Notes	Changes to this parameter will not be applied until Update Changes command is sent. See “RB Parameter Manager (Uplink)” on page 1118 section for more details.
Dependencies	Enabled when Detection is Manual. When this parameter is set to OFF, all of soft keys for PRACH parameter are grayed out.
Preset	OFF
State Saved	Saved in instrument state.
Initial S/W Revision	A.03.00

Auto Detect PRACH Active

Selects whether or not PRACH exists in the input signal when Detection is Auto.

Key Path	Meas Setup, Chan Profile Setup, Edit User Mapping
Mode	LTE, LTETDD
Remote Command	[:SENSe] :EVM:ULINk:PROFile:AUTO:PRACH:ACTive OFF ON 0 1 [:SENSe] :EVM:ULINk:PROFile:AUTO:PRACH:ACTive?
Example	EVM:ULIN:PROF:AUTO:PRAC:ACT OFF EVM:ULIN:PROF:AUTO:PRAC:ACT?
Notes	Changes to this parameter will not be applied until Update Changes command is sent. See “RB Parameter Manager (Uplink)” on page 1118 section for more details.
Dependencies	Enabled when Detection is Auto.
Preset	OFF
State Saved	Saved in instrument state.
Initial S/W Revision	A.03.00

Resource Block Offset (nRAPRB)

Sets the number of Resource Block that PRACH is offset from 0 in the frequency domain (n_{PRB}^{RA}) when Detection is Manual. (3GPP TS 36.211 V8.5.0 5.7)

For PRACH preamble formats 0–3, this parameter is used to calculate the start location in frequency for the PRACH preamble. This parameter does not affect the start location of format 4 preamble.

Key Path	Meas Setup, Chan Profile Setup, Edit User Mapping, PRACH Setup
Mode	LTE, LTETDD
Remote Command	[:SENSe] :EVM:ULINk:PROFile:USER<n>:PRACH:NRAPrb <integer> [:SENSe] :EVM:ULINk:PROFile:USER<n>:PRACH:NRAPrb?
Example	EVM:ULIN:PROF:USER1:PRACH:NRAP 1 EVM:ULIN:PROF:USER1:PRACH:NRAP?
Notes	Changes to this parameter will not be applied until Update Changes command is sent. See “RB Parameter Manager (Uplink)” on page 1118 section for more details.
Dependencies	The range of sub op code <n> values is determined by the number of Users the user has configured. If the user attempts to remotely set or query a sub op code that is out of range, this will result in an error message. The maximum value is [number of resource blocks in a slot] – 6. Enabled when Detection is Manual and PRACH Active is ON.
Preset	0
State Saved	Saved in instrument state.
Min	0
Max	94 - The maximum value is [number of resource blocks in a slot] – 6. [number of resource blocks in a slot] is determined by Bandwidth setting. 0 – Bandwidth 1.4 MHz 9 - Bandwidth 3 MHz 19 - Bandwidth 5 MHz 44 - Bandwidth 10 MHz 69 - Bandwidth 15 MHz 94 - Bandwidth 20 MHz
Initial S/W Revision	A.03.00

Auto Detect Resource Block Offset (nRAPRB)

Sets the number of Resource Block that PRACH is offset from 0 in the frequency domain (n_{PRB}^{RA}) when

LTE Modulation Analysis Measurement
Meas Setup (Measurement Setup)

Detection is Auto. (3GPP TS 36.211 V8.5.0 5.7)

Key Path	Meas Setup, Chan Profile Setup, Edit User Mapping, PRACH Setup
Mode	LTE, LTETDD
Remote Command	[:SENSe] :EVM:ULINK:PROFile:AUTO:PRACH:NRAPrb <integer> [:SENSe] :EVM:ULINK:PROFile:AUTO:PRACH:NRAPrb?
Example	EVM:ULIN:PROF:AUTO:PRACH:NRAP 1 EVM:ULIN:PROF:AUTO:PRACH:NRAP?
Notes	Changes to this parameter will not be applied until Update Changes command is sent. See “ RB Parameter Manager (Uplink) ” on page 1118 section for more details.
Dependencies	Enabled when Detection is Auto and Auto Detect PRACH Active is ON.
Preset	0
State Saved	Saved in instrument state.
Min	0
Max	94 - The maximum value is [number of resource blocks in a slot] – 6. [number of resource blocks in a slot] is determined by Bandwidth setting. 0 – Bandwidth 1.4 MHz 9 - Bandwidth 3 MHz 19 - Bandwidth 5 MHz 44 - Bandwidth 10 MHz 69 - Bandwidth 15 MHz 94 - Bandwidth 20 MHz
Initial S/W Revision	A.03.00

Configuration Index

Sets PRACH Configuration Index to give frame structure when Detection is Manual. (3GPP TS 36.211 V8.5.0 5.7)

This parameter determines the PRACH preamble format and the locations where PRACH can be transmitted in the frame.

This information is given in table 5.7.1–2 for frame type 1 FDD signals and in table 5.7.1–3 for frame type 2 TDD signals in 3GPP TS 36.211.

Key Path	Meas Setup, Chan Profile Setup, Edit User Mapping, PRACH Setup
Mode	LTE, LTETDD
Remote Command	[:SENSe] :EVM:ULINK:PROFile:USER<n>:PRACH:CINdex <integer> [:SENSe] :EVM:ULINK:PROFile:USER<n>:PRACH:CINdex?

Example	EVM:ULIN:PROF:USER1:PRACH:CIND 1 EVM:ULIN:PROF:USER1:PRACH:CIND?
Notes	Changes to this parameter will not be applied until Update Changes command is sent. See “RB Parameter Manager (Uplink)” on page 1118 section for more details.
Dependencies	The range of sub op code <n> values is determined by the number of Users the user has configured. If the user attempts to remotely set or query a sub op code that is out of range, this will result in an error message. Enabled when Detection is Manual and PRACH Active is ON.
Preset	0
State Saved	Saved in instrument state.
Min	0
Max	LTE: 63 LTETDD: 57
Initial S/W Revision	A.03.00

Auto Detect Configuration Index

Sets the PRACH Configuration Index to give frame structure when Detection is Auto. (3GPP TS 36.211 V8.5.0 5.7)

Key Path	Meas Setup, Chan Profile Setup, Edit User Mapping, PRACH Setup
Mode	LTE, LTETDD
Remote Command	[:SENSE]:EVM:ULINK:PROfile:AUTO:PRACH:CINDex <integer> [:SENSE]:EVM:ULINK:PROfile:AUTO:PRACH:CINDex?
Example	EVM:ULIN:PROF:AUTO:PRACH:CIND 1 EVM:ULIN:PROF:AUTO:PRACH:CIND?
Notes	Changes to this parameter will not be applied until Update Changes command is sent. See “RB Parameter Manager (Uplink)” on page 1118 section for more details.
Dependencies	Enabled when Detection is Auto and Auto Detect PRACH Active is ON.
Preset	0
State Saved	Saved in instrument state.
Min	0
Max	LTE: 63 LTETDD: 57

LTE Modulation Analysis Measurement
Meas Setup (Measurement Setup)

Initial S/W Revision	A.03.00
----------------------	---------

Logical Root Seq Index

Sets the Logical Root Seq Index to give root Zadoff-Chu sequence order when Detection is Manual. (3GPP TS 36.211 V8.5.0 5.7)

For preamble formats 0–3, there are 838 total logical indexes. For preamble format 4, there are 138 logical indexes.

The mapping between logical and physical Zadoff-Chu indexes is given in Table 5.7.2–4 for preamble formats 0–3 and in Table 5.7.2–5 for preamble format 4 in TS 36.211.

Key Path	Meas Setup, Chan Profile Setup, Edit User Mapping, PRACH Setup
Mode	LTE, LTETDD
Remote Command	[:SENSe] :EVM:ULINk:PROFile:USER<n>:PRACH:LRSindex <integer> [:SENSe] :EVM:ULINk:PROFile:USER<n>:PRACH:LRSindex?
Example	EVM:ULIN:PROF:USER1:PRACH:LRS 1 EVM:ULIN:PROF:USER1:PRACH:LRS?
Notes	Changes to this parameter will not be applied until Update Changes command is sent. See “RB Parameter Manager (Uplink)” on page 1118 section for more details.
Dependencies	The range of sub op code <n> values is determined by the number of Users the user has configured. If the user attempts to remotely set or query a sub op code that is out of range, this will result in an error message. Enabled when Detection is Manual and PRACH Active is ON.
Preset	0
State Saved	Saved in instrument state.
Min	0
Max	837
Initial S/W Revision	A.03.00

Auto Detect Logical Root Seq Index

Sets Logical Root Seq Index to give root Zadoff-Chu sequence order when Detection is Auto. (3GPP TS 36.211 V8.5.0 5.7)

Key Path	Meas Setup, Chan Profile Setup, Edit User Mapping, PRACH Setup
Mode	LTE, LTETDD

Remote Command	[:SENSe]:EVM:ULINk:PROFile:AUTO:PRACH:LRSindex <integer> [:SENSe]:EVM:ULINk:PROFile:AUTO:PRACH:LRSindex?
Example	EVM:ULIN:PROF:AUTO:PRACH:LRS 1 EVM:ULIN:PROF:AUTO:PRACH:LRS?
Notes	Changes to this parameter will not be applied until Update Changes command is sent. See “ RB Parameter Manager (Uplink) ” on page 1118 section for more details.
Dependencies	Enabled when Detection is Auto and Auto Detect PRACH Active is ON.
Preset	0
State Saved	Saved in instrument state.
Min	0
Max	837
Initial S/W Revision	A.03.00

Cyclic Shift Set

Sets Cyclic Shift Set to give N_{CS} (Number of Cyclic Shifts) for PRACH preamble sequence generation when Detection is Manual. Value of N_{CS} will be determined by this selection and value of N_{CS} Configuration. (3GPP TS 36.211 V8.5.0 Table 5.7.2–2)

Key Path	Meas Setup, Chan Profile Setup, Edit User Mapping, PRACH Setup
Mode	LTE, LTETDD
Remote Command	[:SENSe]:EVM:ULINk:PROFile:USER<n>:PRACH:CSSet UNREstricted REStRicted [:SENSe]:EVM:ULINk:PROFile:USER<n>:PRACH:CSSet?
Example	EVM:ULIN:PROF:USER1:PRAC:CSS UNR EVM:ULIN:PROF:USER1:PRAC:CSS?
Notes	Changes to this parameter will not be applied until Update Changes command is sent. See “ RB Parameter Manager (Uplink) ” on page 1118 section for more details.
Dependencies	The range of sub op code <n> values is determined by the number of Users the user has configured. Enabled when Detection is Manual and PRACH Active is ON.
Preset	UNREstricted
State Saved	Saved in instrument state.
Range	Unrestricted Restricted
Initial S/W Revision	A.03.00

LTE Modulation Analysis Measurement
Meas Setup (Measurement Setup)

Auto Detect Cyclic Shift Set

Sets Cyclic Shift Set to give N_{CS} (Number of Cyclic Shifts) for PRACH preamble sequence generation when Detection is Auto. Value of N_{CS} will be determined by this selection and value of N_{CS} Configuration. (3GPP TS 36.211 V8.5.0 Table 5.7.2–3)

Key Path	Meas Setup, Chan Profile Setup, Edit User Mapping, PRACH Setup
Mode	LTE, LTETDD
Remote Command	[:SENSe] :EVM:ULINK:PROFile:AUTO:PRACH:CSSet UNRestricted RESTRicted [:SENSe] :EVM:ULINK:PROFile:AUTO:PRACH:CSSet?
Example	EVM:ULIN:PROF:AUTO:PRAC:CSS UNR EVM:ULIN:PROF:AUTO:PRAC:CSS?
Notes	Changes to this parameter will not be applied until Update Changes command is sent. See “ RB Parameter Manager (Uplink) ” on page 1118 section for more details.
Dependencies	Enabled when Detection is Auto and Auto Detect PRACH Active is ON.
Preset	UNRestricted
State Saved	Saved in instrument state.
Range	Unrestricted Restricted
Initial S/W Revision	A.03.00

NCS Configuration

Sets the Cyclic Shift Configuration Number to give N_{CS} (Number of Cyclic Shifts) PRACH preamble sequence generation when Detection is Manual. Value of N_{CS} will be determined by this value and selection of Cyclic Shift Set. (3GPP TS 36.211 V8.5.0 Table 5.7.2–2,3)

Key Path	Meas Setup, Chan Profile Setup, Edit User Mapping, PRACH Setup
Mode	LTE, LTETDD
Remote Command	[:SENSe] :EVM:ULINK:PROFile:USER<n>:PRACH:NCSConfig <integer> [:SENSe] :EVM:ULINK:PROFile:USER<n>:PRACH:NCSConfig?
Example	EVM:ULIN:PROF:USER1:PRACH:NCSC 1 EVM:ULIN:PROF:USER1:PRACH:NCSC?
Notes	Changes to this parameter will not be applied until Update Changes command is sent. See “ RB Parameter Manager (Uplink) ” on page 1118 section for more details.

Dependencies	The range of sub op code <n> values is determined by the number of Users the user has configured. If the user attempts to remotely set or query a sub op code that is out of range, this will result in an error message. Enabled when Detection is Manual and PRACH Active is ON.
Preset	0
State Saved	Saved in instrument state.
Min	0
Max	15
Initial S/W Revision	A.03.00

Auto Detect NCS Configuration

Sets the Cyclic Shift Configuration Number to give N_{CS} (Number of Cyclic Shifts) PRACH preamble sequence generation when Detection is Auto. Value of N_{CS} will be determined by this value and selection of Cyclic Shift Set. (3GPP TS 36.211 V8.5.0 Table 5.7.2–3)

Key Path	Meas Setup, Chan Profile Setup, Edit User Mapping, PRACH Setup
Mode	LTE, LTETDD
Remote Command	[:SENSe] :EVM:ULINk:PROFile:AUTO:PRACH:NCSConfig <integer> [:SENSe] :EVM:ULINk:PROFile:AUTO:PRACH:NCSConfig?
Example	EVM:ULIN:PROF:AUTO:PRAC:NCSC 1 EVM:ULIN:PROF:AUTO:PRAC:NCSC?
Notes	Changes to this parameter will not be applied until Update Changes command is sent. See “ RB Parameter Manager (Uplink) ” on page 1118 section for more details.
Dependencies	Enabled when Detection is Auto and Auto Detect PRACH Active is ON.
Preset	0
State Saved	Saved in instrument state.
Min	0
Max	15
Initial S/W Revision	A.03.00

Preamble Index

Sets the Preamble Index when Detection is Manual. Preamble sequence generation is presented on 3GPP TS 36.211 V8.5.0 – 5.7.2.

Key Path	Meas Setup, Chan Profile Setup, Edit User Mapping, PRACH Setup
----------	---

LTE Modulation Analysis Measurement
Meas Setup (Measurement Setup)

Mode	LTE, LTETDD
Remote Command	[:SENSe]:EVM:ULINK:PROFile:USER<n>:PRACH:PINdex <integer> [:SENSe]:EVM:ULINK:PROFile:USER<n>:PRACH:PINdex?
Example	EVM:ULIN:PROF:USER1:PRACH:PIND 1 EVM:ULIN:PROF:USER1:PRACH:PIND?
Notes	Changes to this parameter will not be applied until Update Changes command is sent. See “RB Parameter Manager (Uplink)” on page 1118 section for more details.
Dependencies	The range of sub op code <n> values is determined by the number of Users the user has configured. If the user attempts to remotely set or query a sub op code that is out of range, this will result in an error message. Enabled when Detection is Manual and PRACH Active is ON.
Preset	0
State Saved	Saved in instrument state.
Min	0
Max	63
Initial S/W Revision	A.03.00

Auto Detect Preamble Index

Sets the Preamble Index when Detection is Auto. Preamble sequence generation is presented on 3GPP TS 36.211 V8.5.0 – 5.7.2.

Key Path	Meas Setup, Chan Profile Setup, Edit User Mapping, PRACH Setup
Mode	LTE, LTETDD
Remote Command	[:SENSe]:EVM:ULINK:PROFile:AUTO:PRACH:PINdex <integer> [:SENSe]:EVM:ULINK:PROFile:AUTO:PRACH: PINdex?
Example	EVM:ULIN:PROF:AUTO:PRAC:PIND 1 EVM:ULIN:PROF:AUTO:PRAC:PIND?
Notes	Changes to this parameter will not be applied until Update Changes command is sent. See “RB Parameter Manager (Uplink)” on page 1118 section for more details.
Dependencies	Enabled when Detection is Auto and Auto Detect PRACH Active is ON.
Preset	0
State Saved	Saved in instrument state.
Min	0

Max	63
Initial S/W Revision	A.03.00

PRACH Power Boost

Sets the PRACH Power Boost value when Detection is Manual.

This parameter specifies the average power of PRACH subcarriers.

Key Path	Meas Setup, Chan Profile Setup, Edit User Mapping, PRACH Setup
Mode	LTE, LTETDD
Remote Command	[:SENSe] :EVM:ULINk:PROFile:USER<n>:PRACH:PWRBoost <rel_ampl> [:SENSe] :EVM:ULINk:PROFile:USER<n>:PRACH:PWRBoost?
Example	EVM:ULIN:PROF:USER1:PRAC:PWRB 1 EVM:ULIN:PROF:USER1:PRAC:PWRB?
Notes	Changes to this parameter will not be applied until Update Changes command is sent. See “RB Parameter Manager (Uplink)” on page 1118 section for more details.
Dependencies	The range of sub op code <n> values is determined by the number of Users the user has configured. If the user attempts to remotely set or query a sub op code that is out of range, this will result in an error message. Enabled when Detection is Manual and PRACH Active is ON.
Preset	0
State Saved	Saved in instrument state.
Min	-100
Max	100
Initial S/W Revision	A.03.00
Modified at S/W Revision	A.04.20

Auto Detect PRACH Power Boost

Sets the PRACH Power Boost value when Detection is Auto.

Key Path	Meas Setup, Chan Profile Setup, Edit User Mapping, PRACH Setup
Mode	LTE, LTETDD
Remote Command	[:SENSe] :EVM:ULINk:PROFile:AUTO:PRACH:PWRBoost <rel_ampl> [:SENSe] :EVM:ULINk:PROFile:AUTO:PRACH:PWRBoost?

LTE Modulation Analysis Measurement
Meas Setup (Measurement Setup)

Example	EVM:ULIN:PROF:AUTO:PRACH:PWRB 1 EVM:ULIN:PROF:AUTO:PRACH:PWRB?
Notes	Changes to this parameter will not be applied until Update Changes command is sent. See “RB Parameter Manager (Uplink)” on page 1118 section for more details.
Dependencies	Enabled when Detection is Auto and Auto Detect PRACH Active is ON.
Preset	0
State Saved	Saved in instrument state.
Min	-100
Max	100
Initial S/W Revision	A.03.00
Modified at S/W Revision	A.04.20

Sync Resource

Sets the index value for random access resource, which is used as a synchronization reference when Detection is Manual. Random access preamble mapping is presented on 3GPP TS 36.211 V8.5.0 5.7 Table 5.7.1-4.

Key Path	Meas Setup, Chan Profile Setup, Edit User Mapping, PRACH Setup
Mode	LTETDD
Remote Command	[:SENSe] :EVM:ULINk:PROFile:USER<n>:PRACH:SRESOURCE <integer> [:SENSe] :EVM:ULINk:PROFile:USER<n>:PRACH:SRESOURCE?
Example	EVM:ULIN:PROF:USER1:PRACH:SRES 0 EVM:ULIN:PROF:USER1:PRACH:SRES?
Notes	Max value of this parameter depends on Configuration Index and UL/DL Configuration. Disabled when the combination of Configuration Index and UL/DL Configuration results in the N/A in 3GPP TS 36.211 V8.5.0 5.7 Table 5.7.1-4.
Notes	Changes to this parameter will not be applied until Update Changes command is sent. See “RB Parameter Manager (Uplink)” on page 1118 section for more details.
Dependencies	The range of sub op code <n> values is determined by the number of Users the user has configured. If the user attempts to remotely set or query a sub op code that is out of range, this will result in an error message. Enabled when the mode is LTE TDD, Detection is Manual, and PRACH Active is ON.
Preset	0

State Saved	Saved in instrument state.
Min	0
Max	5
Initial S/W Revision	A.03.00

Auto Detect Sync Resource

Sets the index value for random access resource, which is used as synchronization reference when Detection is Auto. Random access preamble mapping is presented on 3GPP TS 36.211 V8.5.0 5.7 Table 5.7.1–4.

Key Path	Meas Setup, Chan Profile Setup, Edit User Mapping, PRACH Setup
Mode	LTETDD
Remote Command	[:SENSE] :EVM:ULINk:PROfile:AUTO:PRACH:SRESource <integer> [:SENSE] :EVM:ULINk:PROfile:AUTO:PRACH:SRESource?
Example	EVM:ULIN:PROF:AUTO:PRACH:SRES 0 EVM:ULIN:PROF:AUTO:PRACH:SRES?
Notes	Max value of this parameter depends on Configuration Index and UL/DL Configuration. This parameter is disabled when the combination of Configuration Index and UL/DL Configuration results in the N/A in 3GPP TS 36.211 V8.5.0 5.7 Table5.7.1–4. Changes to this parameter will not be applied until Update Changes command is sent. See “ RB Parameter Manager (Uplink) ” on page 1118 section for more details.
Dependencies	Enabled when the mode is LTE TDD, Detection is Auto and Auto Detect PRACH Active is ON.
Preset	0
State Saved	Saved in instrument state.
Min	0
Max	5
Initial S/W Revision	A.03.00

S-RS Parameters

Displays a menu that enables you to set S-RS channel parameters for signals.

Key Path	Meas Setup, Chan Profile Setup, Edit User Mapping, S-RS Parameters
Mode	LTE, LTETDD
Initial S/W Revision	Prior to A.02.00
Modified at S/W Revision	A.03.00

LTE Modulation Analysis Measurement
Meas Setup (Measurement Setup)

S-RS Active

Selects whether or not S-RS exists in the input signal when Detection is Manual.

Key Path	Meas Setup, Chan Profile Setup, Edit User Mapping
Mode	LTE, LTETDD
Remote Command	[:SENSe]:EVM:ULINk:PROFile:USER1 50:SRS:ACTive OFF ON 0 1 [:SENSe]:EVM:ULINk:PROFile:USER1 50:SRS:ACTive?
Example	EVM:ULIN:PROF:USER1:SRS:ACT OFF EVM:ULIN:PROF:USER1:SRS:ACT?
Notes	Changes to this parameter will not be applied until Update Changes command is sent. See “RB Parameter Manager (Uplink)” on page 1118 section for more details.
Dependencies	Enabled when Detection is Manual. When this parameter is set to OFF, all of soft keys for S-RS parameter are grayed out.
Preset	OFF
State Saved	Saved in instrument state.
Initial S/W Revision	A.03.00

Auto Detect S-RS Active

Selects whether or not S-RS exists in the input signal when Detection is Auto.

Key Path	Meas Setup, Chan Profile Setup, Edit User Mapping
Mode	LTE, LTETDD
Remote Command	[:SENSe]:EVM:ULINk:PROFile:AUTO:SRS:ACTive OFF ON 0 1 [:SENSe]:EVM:ULINk:PROFile:AUTO:SRS:ACTive?
Example	EVM:ULIN:PROF:AUTO:SRS:ACT OFF EVM:ULIN:PROF:AUTO:SRS:ACT?
Notes	Changes to this parameter will not be applied until Update Changes command is sent. See “RB Parameter Manager (Uplink)” on page 1118 section for more details.
Dependencies	Enabled when Detection is Auto.
Preset	OFF
State Saved	Saved in instrument state.
Initial S/W Revision	A.03.00

Cyclic Shift (nSRSCS)

Sets S-RS Cyclic Shift when Detection is Manual. This value determines the cyclic shift of R-RS.

Key Path	Meas Setup, Chan Profile Setup, Edit User Mapping, SRS Setup
Mode	LTE, LTETDD
Remote Command	[:SENSe]:EVM:ULINk:PROfile:USER<n>:SRS:CSHift <integer> [:SENSe]:EVM:ULINk:PROfile:USER<n>:SRS:CSHift?
Example	EVM:ULIN:PROF:USER1:SRS:CSH 1 EVM:ULIN:PROF:USER1:SRS:CSH?
Notes	Changes to this parameter will not be applied until Update Changes command is sent. See “RB Parameter Manager (Uplink)” on page 1118 section for more details.
Dependencies	The range of sub op code <n> values is determined by the number of Users the user has configured. If the user attempts to remotely set or query a sub op code that is out of range, this will result in an error message. Enabled when Detection is Manual and S-RS Active is ON.
Preset	0
State Saved	Saved in instrument state.
Min	0
Max	7
Initial S/W Revision	A.03.00

Auto Detect Cyclic Shift

Sets S-RS Cyclic Shift when Detection is Auto.

Key Path	Meas Setup, Chan Profile Setup, Edit User Mapping, SRS Setup
Mode	LTE, LTETDD
Remote Command	[:SENSe]:EVM:ULINk:PROfile:AUTO:SRS:CSHift <integer> [:SENSe]:EVM:ULINk:PROfile:AUTO:SRS:CSHift?
Example	EVM:ULIN:PROF:AUTO:SRS:CSH 1 EVM:ULIN:PROF:AUTO:SRS:CSH?
Notes	Changes to this parameter will not be applied until Update Changes command is sent. See “RB Parameter Manager (Uplink)” on page 1118 section for more details.
Dependencies	Enabled when Detection is Auto and Auto Detect S-RS Active is ON
Preset	0

LTE Modulation Analysis Measurement
Meas Setup (Measurement Setup)

State Saved	Saved in instrument state.
Min	0
Max	7
Initial S/W Revision	A.03.00

Bandwidth Configuration (CSRS)

Sets S-RS Bandwidth Configuration (C_{SRS}) when Detection is Manual.

This parameter, along with B_{SRS} , determines the values of $m_{SRS,b}$ and N_b from tables 5.5.3.2–1 through 5.5.3.2–4 in TS 36.211.

Key Path	Meas Setup, Chan Profile Setup, Edit User Mapping, SRS Setup
Mode	LTE, LTETDD
Remote Command	[:SENSe] :EVM:ULINk:PROFile:USER<n>:SRS:BCONfig <integer> [:SENSe] :EVM:ULINk:PROFile:USER<n>:SRS:BCONfig?
Example	EVM:ULIN:PROF:USER1:SRS:BCON 1 EVM:ULIN:PROF:USER1:SRS:BCON?
Notes	Changes to this parameter will not be applied until Update Changes command is sent. See “RB Parameter Manager (Uplink)” on page 1118 section for more details.
Dependencies	The range of sub op code <n> values is determined by the number of Users the user has configured. If the user attempts to remotely set or query a sub op code that is out of range, this will result in an error message. Enabled when Detection is Manual and S-RS Active is ON.
Preset	7
State Saved	Saved in instrument state.
Min	0
Max	7
Initial S/W Revision	A.03.00

Auto Detect Bandwidth Configuration (CSRS)

Sets S-RS Bandwidth Configuration (C_{SRS}) when Detection is Auto.

Key Path	Meas Setup, Chan Profile Setup, Edit User Mapping, SRS Setup
Mode	LTE, LTETDD

Remote Command	[:SENSE]:EVM:ULINK:PROFile:AUTO:SRS:BCONfig <integer> [:SENSE]:EVM:ULINK:PROFile:AUTO:SRS:BCONfig?
Example	EVM:ULIN:PROF:AUTO:SRS:BCON 1 EVM:ULIN:PROF:AUTO:SRS:BCON?
Notes	Changes to this parameter will not be applied until Update Changes command is sent. See “RB Parameter Manager (Uplink)” on page 1118 section for more details.
Dependencies	Enabled when Detection is Auto and Auto Detect S-RS Active is ON
Preset	7
State Saved	Saved in instrument state.
Min	0
Max	7
Initial S/W Revision	A.03.00

Bandwidth (BSRS)

Sets S-RS Bandwidth (B_{SRS}) when Detection is Manual. This parameter, along with C_{SRS} , determines the values of $m_{SRS,b}$ and N_b from tables 5.5.3.2–1 through 5.5.3.2–4 in TS 36.211.

Key Path	Meas Setup, Chan Profile Setup, Edit User Mapping, SRS Setup
Mode	LTE, LTETDD
Remote Command	[:SENSE]:EVM:ULINK:PROFile:USER<n>:SRS:BWIDth <integer> [:SENSE]:EVM:ULINK:PROFile:USER<n>:SRS:BWIDth?
Example	EVM:ULIN:PROF:USER1:SRS:BWID 1 EVM:ULIN:PROF:USER1:SRS:BWID?
Notes	Changes to this parameter will not be applied until Update Changes command is sent. See “RB Parameter Manager (Uplink)” on page 1118 section for more details.
Dependencies	The range of sub op code <n> values is determined by the number of Users the user has configured. If the user attempts to remotely set or query a sub op code that is out of range, this will result in an error message. Enabled when Detection is Manual, and S-RS Active is ON.
Preset	0
State Saved	Saved in instrument state.
Min	0
Max	3

LTE Modulation Analysis Measurement
Meas Setup (Measurement Setup)

Initial S/W Revision	A.03.00
----------------------	---------

Auto Detect Bandwidth (BSRS)

Sets S-RS Bandwidth (B_{SRS}) when Detection is Auto.

Key Path	Meas Setup, Chan Profile Setup, Edit User Mapping, SRS Setup
Mode	LTE, LTETDD
Remote Command	[:SENSe] :EVM:ULINK:PROFile:AUTO:SRS:BWIDth <integer> [:SENSe] :EVM:ULINK:PROFile:AUTO:SRS:BWIDth?
Example	EVM:ULIN:PROF:AUTO:SRS:BWID 1 EVM:ULIN:PROF:AUTO:SRS:BWID?
Notes	Changes to this parameter will not be applied until Update Changes command is sent. See “RB Parameter Manager (Uplink)” on page 1118 section for more details.
Dependencies	Enabled when Detection is Auto and Auto Detect S-RS Active is ON
Preset	0
State Saved	Saved in instrument state.
Min	0
Max	3
Initial S/W Revision	A.03.00

Transmission Comb (kTC)

Sets Transmission Comb (k_{TC}) of S-RS when Detection is Manual.

This parameter influences the starting frequency location of S-RS.

Key Path	Meas Setup, Chan Profile Setup, Edit User Mapping, SRS Setup
Mode	LTE, LTETDD
Remote Command	[:SENSe] :EVM:ULINK:PROFile:USER<n>:SRS:TCOMb <integer> [:SENSe] :EVM:ULINK:PROFile:USER<n>:SRS:TCOMb?
Example	EVM:ULIN:PROF:USER1:SRS:TCOM 1 EVM:ULIN:PROF:USER1:SRS:TCOM?
Notes	Changes to this parameter will not be applied until Update Changes command is sent. See “RB Parameter Manager (Uplink)” on page 1118 section for more details.

Dependencies	The range of sub op code <n> values is determined by the number of Users the user has configured. If the user attempts to remotely set or query a sub op code that is out of range, this will result in an error message. Enabled when Detection is Manual and S-RS Active is ON.
Preset	0
State Saved	Saved in instrument state.
Min	0
Max	1
Initial S/W Revision	A.03.00

Auto Detect Transmission Comb (kTC)

Sets Transmission Comb (k_{TC}) of S-RS when Detection is Auto.

Key Path	Meas Setup, Chan Profile Setup, Edit User Mapping, SRS Setup
Mode	LTE, LTETDD
Remote Command	[:SENSE]:EVM:ULINK:PROFile:AUTO:SRS:TCOMb <integer> [:SENSE]:EVM:ULINK:PROFile:AUTO:SRS:TCOMb?
Example	EVM:ULIN:PROF:AUTO:SRS:TCOM 1 EVM:ULIN:PROF:AUTO:SRS:TCOM?
Notes	Changes to this parameter will not be applied until Update Changes command is sent. See “RB Parameter Manager (Uplink)” on page 1118 section for more details.
Dependencies	Enabled when Detection is Auto and Auto Detect S-RS Active is ON.
Preset	0
State Saved	Saved in instrument state.
Min	0
Max	1
Initial S/W Revision	A.03.00

Hopping Bandwidth (bhop)

Sets S-RS Hopping Bandwidth (b_{hop}) when Detection is Manual.

Key Path	Meas Setup, Chan Profile Setup, Edit User Mapping, SRS Setup
Mode	LTE, LTETDD

LTE Modulation Analysis Measurement
Meas Setup (Measurement Setup)

Remote Command	[:SENSe]:EVM:ULINK:PROFile:USER<n>:SRS:HBWidth <integer> [:SENSe]:EVM:ULINK:PROFile:USER<n>:SRS:HBWidth?
Example	EVM:ULIN:PROF:USER1:SRS:HBW 1 EVM:ULIN:PROF:USER1:SRS:HBW?
Notes	Changes to this parameter will not be applied until Update Changes command is sent. See “RB Parameter Manager (Uplink)” on page 1118 section for more details.
Dependencies	The range of sub op code <n> values is determined by the number of Users the user has configured. If the user attempts to remotely set or query a sub op code that is out of range, this will result in an error message. Enabled when Detection is Manual and S-RS Active is ON
Preset	3
State Saved	Saved in instrument state.
Min	0
Max	3
Initial S/W Revision	A.03.00
Modified at S/W Revision	A.06.00

Auto Detect Hopping Bandwidth (bhop)

Sets S-RS Hopping Bandwidth (b_{hop}) when Detection is Auto.

Key Path	Meas Setup, Chan Profile Setup, Edit User Mapping, SRS Setup
Mode	LTE, LTETDD
Remote Command	[:SENSe]:EVM:ULINK:PROFile:AUTO:SRS:HBWidth <integer> [:SENSe]:EVM:ULINK:PROFile:AUTO:SRS:HBWidth?
Example	EVM:ULIN:PROF:AUTO:SRS:HBW 1 EVM:ULIN:PROF:AUTO:SRS:HBW?
Notes	Changes to this parameter will not be applied until Update Changes command is sent. See “RB Parameter Manager (Uplink)” on page 1118 section for more details.
Dependencies	Enabled when Detection is Auto and Auto Detect S-RS Active is ON
Preset	3
State Saved	Saved in instrument state.
Min	0

Max	3
Initial S/W Revision	A.03.00
Modified at S/W Revision	A.06.00

Frequency Domain Position (nRRC)

Sets the S-RS Frequency Domain Position (n_{RRC}) when Detection is Manual.

Key Path	Meas Setup, Chan Profile Setup, Edit User Mapping, SRS Setup
Mode	LTE, LTETDD
Remote Command	[:SENSe] :EVM:ULINK:PROFile:USER<n>:SRS:FDPosition <integer> [:SENSe] :EVM:ULINK:PROFile:USER<n>:SRS:FDPosition?
Example	EVM:ULIN:PROF:USER1:SRS:FDP 1 EVM:ULIN:PROF:USER1:SRS:FDP?
Notes	Changes to this parameter will not be applied until Update Changes command is sent. See “RB Parameter Manager (Uplink)” on page 1118 section for more details.
Dependencies	The range of sub op code <n> values is determined by the number of Users the user has configured. If the user attempts to remotely set or query a sub op code that is out of range, this will result in an error message. Enabled when Detection is Manual and S-RS Active is ON.
Preset	0
State Saved	Saved in instrument state.
Min	0
Max	23
Initial S/W Revision	A.03.00
Modified at S/W Revision	A.06.00

Auto Detect Frequency Domain Position (nRRC)

Sets the S-RS Frequency Domain Position (n_{RRC}) when Detection is Auto.

Key Path	Meas Setup, Chan Profile Setup, Edit User Mapping, SRS Setup
Mode	LTE, LTETDD
Remote Command	[:SENSe] :EVM:ULINK:PROFile:AUTO:SRS:FDPosition <integer> [:SENSe] :EVM:ULINK:PROFile:AUTO:SRS:FDPosition?

LTE Modulation Analysis Measurement
Meas Setup (Measurement Setup)

Example	EVM:ULIN:PROF:AUTO:SRS:FDP 1 EVM:ULIN:PROF:AUTO:SRS:FDP?
Notes	Changes to this parameter will not be applied until Update Changes command is sent. See “RB Parameter Manager (Uplink)” on page 1118 section for more details.
Dependencies	Enabled when Detection is Auto and Auto Detect S-RS Active is ON
Preset	0
State Saved	Saved in instrument state.
Min	0
Max	23
Initial S/W Revision	A.03.00
Modified at S/W Revision	A.06.00

Subframe Configuration

Sets the value for srsSubframeConfiguration in Table 5.5.3.3–1 (FDD) or Table 5.5.3.3–2 (TDD) in TS 36.211 when Detection is Manual.

srsSubframeConfiguration determines T_{SFC} and D_{SFC} .

Key Path	Meas Setup, Chan Profile Setup, Edit User Mapping, SRS Setup
Mode	LTE, LTETDD
Remote Command	[:SENSE] :EVM:ULINK:PROFile:USER<n>:SRS:SFCConfig <integer> [:SENSE] :EVM:ULINK:PROFile:USER<n>:SRS:SFCConfig?
Example	EVM:ULIN:PROF:USER1:SRS:SFC 1 EVM:ULIN:PROF:USER1:SRS:SFC?
Notes	Changes to this parameter will not be applied until Update Changes command is sent. See “RB Parameter Manager (Uplink)” on page 1118 section for more details.
Dependencies	The range of sub op code <n> values is determined by the number of Users the user has configured. If the user attempts to remotely set or query a sub op code that is out of range, this will result in an error message. Enabled when Detection is Manual and S-RS Active is ON.
Preset	0
State Saved	Saved in instrument state.
Min	0
Max	15

Initial S/W Revision	A.03.00
----------------------	---------

Auto Detect Subframe Configuration

Sets the value for srsSubframeConfiguration in Table 5.5.3.3–1 (FDD) or Table 5.5.3.3–2 (TDD) in TS 36.211 when Detection is Auto.

Key Path	Meas Setup, Chan Profile Setup, Edit User Mapping, SRS Setup
Mode	LTE, LTETDD
Remote Command	[:SENSE]:EVM:ULINK:PROFile:AUTO:SRS:SFConfig <integer> [:SENSE]:EVM:ULINK:PROFile:AUTO:SRS:SFConfig?
Example	EVM:ULIN:PROF:AUTO:SRS:SFC 1 EVM:ULIN:PROF:AUTO:SRS:SFC?
Notes	Changes to this parameter will not be applied until Update Changes command is sent. See “ RB Parameter Manager (Uplink) ” on page 1118 section for more details.
Dependencies	Enabled when Detection is Auto and Auto Detect S-RS Active is ON
Preset	0
State Saved	Saved in instrument state.
Min	0
Max	15
Initial S/W Revision	A.03.00

S-RS Power Boost

Sets S-RS Power Boost value when Detection is Manual.

This value specifies the average power for SRS.

NOTE All channel and signal powers are relative to the 0 dB level determined by the power of the channel/signal chosen for synchronization.

Key Path	Meas Setup, Chan Profile Setup, Edit User Mapping, SRS Setup
Mode	LTE, LTETDD
Remote Command	[:SENSE]:EVM:ULINK:PROFile:USER<n>:SRS:PWRBoost <rel_ampl> [:SENSE]:EVM:ULINK:PROFile:USER<n>:SRS:PWRBoost?
Example	EVM:ULIN:PROF:USER1:SRS:PWRB 1 EVM:ULIN:PROF:USER1:SRS:PWRB?

LTE Modulation Analysis Measurement
Meas Setup (Measurement Setup)

Notes	Changes to this parameter will not be applied until Update Changes command is sent. See “RB Parameter Manager (Uplink)” on page 1118 section for more details.
Dependencies	The range of sub op code <n> values is determined by the number of Users the user has configured. If the user attempts to remotely set or query a sub op code that is out of range, this will result in an error message. Enabled when Detection is Manual and S-RS Active is ON.
Preset	0
State Saved	Saved in instrument state.
Min	-100
Max	100
Initial S/W Revision	A.03.00
Modified at S/W Revision	A.04.20

Auto Detect S-RS Power Boost

Sets the S-RS Power Boost value when Detection is Auto.

Key Path	Meas Setup, Chan Profile Setup, Edit User Mapping, SRS Setup
Mode	LTE, LTETDD
Remote Command	[:SENSe]:EVM:ULINk:PROFile:AUTO:SRS:PWRBoost <rel_ampl> [:SENSe]:EVM:ULINk:PROFile:AUTO:SRS:PWRBoost?
Example	EVM:ULIN:PROF:AUTO:SRS:PWRB 1 EVM:ULIN:PROF:AUTO:SRS:PWRB?
Notes	Changes to this parameter will not be applied until Update Changes command is sent. See “RB Parameter Manager (Uplink)” on page 1118 section for more details.
Dependencies	Enabled when Detection is Auto and Auto Detect S-RS Active is ON.
Preset	0
State Saved	Saved in instrument state.
Min	-100
Max	100
Initial S/W Revision	A.03.00
Modified at S/W Revision	A.04.20

Configuration Index (ISRS)

Sets the S-RS Configuration Index (I_{SRS}) when Detection is Manual. (3GPP TS 36.213 V8.5.0 8.2 Table 8.2–1~2)

The S-RS Configuration Index value determines S-RS periodicity and subframe offset configuration from Table 8.2–1 for FDD and Table 8.2–2 for TDD in 3GPP TS 36.213.

Key Path	Meas Setup, Chan Profile Setup, Edit User Mapping, SRS Setup
Mode	LTE, LTETDD
Remote Command	[:SENSe]:EVM:ULINk:PROFile:USER<n>:SRS:CINDeX <integer> [:SENSe]:EVM:ULINk:PROFile:USER<n>:SRS:CINDeX?
Example	EVM:ULIN:PROF:USER1:SRS:CIND 1 EVM:ULIN:PROF:USER1:SRS:CIND?
Notes	Changes to this parameter will not be applied until Update Changes command is sent. See “RB Parameter Manager (Uplink)” on page 1118 section for more details.
Dependencies	The range of sub op code <n> values is determined by the number of Users the user has configured. If the user attempts to remotely set or query a sub op code that is out of range, this will result in an error message. Enabled when Detection is Manual and S-RS Active is ON
Preset	0
State Saved	Saved in instrument state.
Min	0
Max	1023
Initial S/W Revision	A.03.00

Auto Detect Configuration Index (ISRS)

Sets the S-RS Configuration Index (I_{SRS}) when Detection is Auto. (3GPP TS 36.213 V8.5.0 8.2 Table 8.2–1~2)

Key Path	Meas Setup, Chan Profile Setup, Edit User Mapping, SRS Setup
Mode	LTE, LTETDD
Remote Command	[:SENSe]:EVM:ULINk:PROFile:AUTO:SRS:CINDeX <integer> [:SENSe]:EVM:ULINk:PROFile:AUTO:SRS:CINDeX?
Example	EVM:ULIN:PROF:AUTO:SRS:CIND 1 EVM:ULIN:PROF:AUTO:SRS:CIND?
Notes	Changes to this parameter will not be applied until Update Changes command is sent. See “RB Parameter Manager (Uplink)” on page 1118 section for more details.

LTE Modulation Analysis Measurement
Meas Setup (Measurement Setup)

Dependencies	Enabled when Detection is Auto and Auto Detect S-RS Active is ON
Preset	0
State Saved	Saved in instrument state.
Min	0
Max	1023
Initial S/W Revision	A.03.00

S-RS Sync Slot

Sets the S-RS Sync Slot when Detection is Manual.

This value specifies the index of the slot to use for initial synchronization. The demodulator searches for the slot with the characteristics specified in Channel Parameters and the slot that matches the Channel Parameters with the highest correlation will be assigned the slot number given in the Sync Slot parameter.

When Sync Slot is set to Auto, the demod algorithm may automatically determine the best time slot to synchronize to. This approach simplifies parameter entry and provides easier setup. However, the complexity of the algorithm makes it rather slow and prone to errors in the presence of noise.

Key Path	Meas Setup, Chan Profile Setup, Edit User Mapping
Mode	LTE, LTETDD
Remote Command	[:SENSE] :EVM:ULINK:PROFile:USER<n>:SRS:SSLot <integer> [:SENSE] :EVM:ULINK:PROFile:USER<n>:SRS:SSLot? [:SENSE] :EVM:ULINK:PROFile:USER<n>:SRS:SSLot:AUTO OFF ON 0 1 [:SENSE] :EVM:ULINK:PROFile:USER<n>:SRS:SSLot:AUTO?
Example	EVM:ULIN:PROF:USER1:SRS:SSL 1 EVM:ULIN:PROF:USER1:SRS:SSL? EVM:ULIN:PROF:USER1:SRS:SSL:AUTO 1 EVM:ULIN:PROF:USER1:SRS:SSL:AUTO?
Notes	Changes to this parameter will not be applied until Update Changes command is sent. See “RB Parameter Manager (Uplink)” on page 1118 section for more details.
Dependencies	The range of sub op code <n> values is determined by the number of Users the user has configured. Max value for n=50 If the user attempts to remotely set or query a sub op code that is out of range, this will result in an error message. S-RS Sync Slot is enabled when S-RS Active is ON, Detection is Manual and S-RS Sync Slot Auto is OFF. S-RS Sync Slot Auto is enabled when S-RS Active is ON and Detection is Manual

Preset	1 ON
State Saved	Saved in instrument state.
Min	1
Max	19
Initial S/W Revision	A.03.00

Auto Detect S-RS Sync Slot

Sets the S-RS Sync Slot when Detection is Auto.

Key Path	Meas Setup, Chan Profile Setup, Edit User Mapping
Mode	LTE, LTETDD
Remote Command	[:SENSe]:EVM:ULINk:PROfile:AUTO:SRS:SSLot <integer> [:SENSe]:EVM:ULINk:PROfile:AUTO:SRS:SSLot? [:SENSe]:EVM:ULINk:PROfile:AUTO:SRS:SSLot:AUTO OFF ON 0 1 [:SENSe]:EVM:ULINk:PROfile:AUTO:SRS:SSLot:AUTO?
Example	EVM:ULIN:PROF:AUTO:SRS:SSL 1 EVM:ULIN:PROF:AUTO:SRS:SSL? EVM:ULIN:PROF:AUTO:SRS:SSL:AUTO 1 EVM:ULIN:PROF:AUTO:SRS:SSL:AUTO?
Notes	Changes to this parameter will not be applied until Update Changes command is sent. See “RB Parameter Manager (Uplink)” on page 1118 section for more details.
Dependencies	Enabled when Detection is Auto and Auto Detect S-RS Active is ON.
Preset	1 ON
State Saved	Saved in instrument state.
Min	1
Max	19
Initial S/W Revision	A.03.00

Max UpPTS

Sets the value of srsMaxUpPts to indicate whether or not $m_{SRS,0}$ reconfiguration is enabled for UpPTS when Detection is Manual, where $m_{SRS,0}$ is given by Table 5.5.3.2–1 through Table 5.5.3.2–4 for each uplink bandwidth

LTE Modulation Analysis Measurement
Meas Setup (Measurement Setup)

in 3GPP TS36.211 v8.5.0.

Key Path	Meas Setup, Chan Profile Setup, Edit User Mapping, SRS Setup
Mode	LTETDD
Remote Command	[:SENSE]:EVM:ULINK:PROF:USER<n>:SRS:MUPTs OFF ON 0 1 [:SENSE]:EVM:ULINK:PROF:USER<n>:SRS:MUPTs?
Example	EVM:ULIN:PROF:USER1:SRS:MUPT 0 EVM:ULIN:PROF:USER1:SRS:MUPT?
Notes	Changes to this parameter will not be applied until Update Changes command is sent. See “RB Parameter Manager (Uplink)” on page 1118 section for more details.
Dependencies	The range of sub op code <n> values is determined by the number of Users the user has configured. Enabled when the mode is LTE TDD, Detection is Manual, and S-RS Active is ON.
Preset	OFF
State Saved	Saved in instrument state.
Initial S/W Revision	A.03.00

Key Path	Meas Setup, Chan Profile Setup, Edit User Mapping, SRS Setup
Mode	LTETDD
Remote Command	[:SENSE]:EVM:ULINK:PROF:AUTO:SRS:MUPTs OFF ON 0 1 [:SENSE]:EVM:ULINK:PROF:AUTO:SRS:MUPTs?
Example	EVM:ULIN:PROF:AUTO:SRS:MUPT 0 EVM:ULIN:PROF:AUTO:SRS:MUPT?
Notes	Changes to this parameter will not be applied until Update Changes command is sent. See “RB Parameter Manager (Uplink)” on page 1118 section for more details.
Dependencies	Enabled when the mode is LTE TDD, Detection is Auto, and Auto Detect S-RS Active is ON.
Preset	OFF
State Saved	Saved in instrument state.
Initial S/W Revision	A.03.00

S-RS NraS1

Sets the format number for PRACH in subframe1’s UpPTS, which is derived from 3GPP TS 36.211 V8.5.0 5.7

Table5.7.1–4.

Key Path	Meas Setup, Chan Profile Setup, Edit User Mapping, SRS Setup
Mode	LTETDD
Remote Command	[:SENSE]:EVM:ULINK:PROF:USER<n>:SRS:NRA:SONe <integer> [:SENSE]:EVM:ULINK:PROF:USER<n>:SRS:NRA:SONe?
Example	EVM:ULIN:PROF:USER1:SRS:NRA:SON 1 EVM:ULIN:PROF:USER1:SRS:NRA:SON?
Notes	Changes to this parameter will not be applied until Update Changes command is sent. See “ RB Parameter Manager (Uplink) ” on page 1118 section for more detail.
Dependencies	The range of sub op code <n> values is determined by the number of Users the user has configured. Max value for n=50 If the user attempts to remotely set or query a sub op code that is out of range, this will result in an error message. Enabled when the mode is LTE TDD, Detection is Manual and S-RS Active is ON.
Preset	0
State Saved	Saved in instrument state.
Min	0
Max	6
Initial S/W Revision	A.03.00

Auto Detect S-RS NraS1

Sets S-RS NraS1 when Auto Detection is On.

Key Path	Meas Setup, Chan Profile Setup, Edit User Mapping, SRS Setup
Mode	LTETDD
Remote Command	[:SENSE]:EVM:ULINK:PROF:AUTO:SRS:NRA:SONe <integer> [:SENSE]:EVM:ULINK:PROF:AUTO:SRS:NRA:SONe?
Example	EVM:ULIN:PROF:AUTO:SRS:NRA:SON 1 EVM:ULIN:PROF:AUTO:SRS:NRA:SON?
Notes	Changes to this parameter will not be applied until Update Changes command is sent. See “ RB Parameter Manager (Uplink) ” on page 1118 section for more detail.
Dependencies	Enabled when the mode is LTE TDD, Detection is Auto and Auto Detect S-RS Active is ON.

LTE Modulation Analysis Measurement
Meas Setup (Measurement Setup)

Preset	0
State Saved	Saved in instrument state.
Min	0
Max	6
Initial S/W Revision	A.03.00

S-RS NraS6

Sets the format number for PRACH in subframe6's UpPTS, which is derived from 3GPP TS 36.211 V8.5.0 5.7 Table5.7.1–4.

Key Path	Meas Setup, Chan Profile Setup, Edit User Mapping, SRS Setup
Mode	LTETDD
Remote Command	[:SENSe] :EVM:ULINk:PROFile:USER<n>:SRS:NRA:SSIX <integer> [:SENSe] :EVM:ULINk:PROFile:USER<n>:SRS:NRA:SSIX?
Example	EVM:ULIN:PROF:USER1:SRS:NRA:SSIX 1 EVM:ULIN:PROF:USER1:SRS:NRA:SSIX?
Notes	Changes to this parameter will not be applied until Update Changes command is sent. See “ RB Parameter Manager (Uplink) ” on page 1118 section for more detail.
Dependencies	The range of sub op code <n> values is determined by the number of Users the user has configured. Max value for n=50 If the user attempts to remotely set or query a sub op code that is out of range, this will result in an error message. Enabled when the mode is LTE TDD, Detection is Manual and S-RS Active is ON.
Preset	0
State Saved	Saved in instrument state.
Min	0
Max	6
Initial S/W Revision	A.03.00

Auto Detect S-RS NraS6

Sets S-RS NraS6 when Auto Detection is On.

Key Path	Meas Setup, Chan Profile Setup, Edit User Mapping, SRS Setup
Mode	LTETDD

Remote Command	[:SENSE]:EVM:ULINK:PROFile:AUTO:SRS:NRA:SSIX <integer> [:SENSE]:EVM:ULINK:PROFile:AUTO:SRS:NRA:SSIX?
Example	EVM:ULIN:PROF:AUTO:SRS:NRA:SSIX 1 EVM:ULIN:PROF:AUTO:SRS:NRA:SSIX?
Notes	Changes to this parameter will not be applied until Update Changes command is sent. See “RB Parameter Manager (Uplink)” on page 1118 section for more detail.
Dependencies	Enabled when the mode is LTE TDD, Detection is Auto and Auto Detect S-RS Active is ON.
Preset	0
State Saved	Saved in instrument state.
Min	0
Max	6
Initial S/W Revision	A.03.00

OK/Cancel

Displays a menu that enables changes to the parameters on the dialog to be applied or cancelled.

This menu appears when the Cancel (Esc) hard key is pressed with no active function available.

Mode	LTE, LTETDD
Initial S/W Revision	Prior to A.02.00
Modified at S/W Revision	A.03.00

OK

Applies all changes made to the parameters on the dialog then exits the dialog.

Mode	LTE, LTETDD
Initial S/W Revision	Prior to A.02.00
Modified at S/W Revision	A.03.00

Cancel

Cancels all changes made to the parameters on the dialog then exits the dialog.

Mode	LTE, LTETDD
Initial S/W Revision	Prior to A.02.00
Modified at S/W Revision	A.03.00

RB Parameter Manager (Uplink)

Reduces the time it takes to configure channel profile related parameters with SCPI commands.

The SCPI command parameters shown below are managed in this scheme.

Note that changes to the parameters are not applied until the Update Changes command is sent. See “Update Changes (Uplink)” on page 1124 section for more details.

[[:SENSe]:EVM:ULINK:PROFile:ADD:USER
[[:SENSe]:EVM:ULINK:PROFile:AUTO:CID
[[:SENSe]:EVM:ULINK:PROFile:AUTO:HOPPIng:GROup
[[:SENSe]:EVM:ULINK:PROFile:AUTO:HOPPIng:SEQuence
[[:SENSe]:EVM:ULINK:PROFile:AUTO:RNTI
[[:SENSe]:EVM:ULINK:PROFile:AUTO:SFNumber
[[:SENSe]:EVM:ULINK:PROFile:AUTO:PRACH:ACTive
[[:SENSe]:EVM:ULINK:PROFile:AUTO:PRACH:CINdex
[[:SENSe]:EVM:ULINK:PROFile:AUTO:PRACH:CSSet
[[:SENSe]:EVM:ULINK:PROFile:AUTO:PRACH:PINdex
[[:SENSe]:EVM:ULINK:PROFile:AUTO:PRACH:LRsindex
[[:SENSe]:EVM:ULINK:PROFile:AUTO:PRACH:NCSConfig
[[:SENSe]:EVM:ULINK:PROFile:AUTO:PRACH:NRAPrb
[[:SENSe]:EVM:ULINK:PROFile:AUTO:PRACH:PWRBoost
[[:SENSe]:EVM:ULINK:PROFile:AUTO:PRACH:SRESource
[[:SENSe]:EVM:ULINK:PROFile:AUTO:PUCCh:ACTive
[[:SENSe]:EVM:ULINK:PROFile:AUTO:PUCCh:CSHift
[[:SENSe]:EVM:ULINK:PROFile:AUTO:PUCCh:DMRS:GROup
[[:SENSe]:EVM:ULINK:PROFile:AUTO:PUCCh:DMRS:PARams
[[:SENSe]:EVM:ULINK:PROFile:AUTO:PUCCh:DMRS:PWRBoost
[[:SENSe]:EVM:ULINK:PROFile:AUTO:PUCCh:FORMat
[[:SENSe]:EVM:ULINK:PROFile:AUTO:PUCCh:N:ONE
[[:SENSe]:EVM:ULINK:PROFile:AUTO:PUCCh:N:TWO
[[:SENSe]:EVM:ULINK:PROFile:AUTO:PUCCh:NCS:ONE
[[:SENSe]:EVM:ULINK:PROFile:AUTO:PUCCh:NRB:TWO

[[:SENSe]:EVM:ULINK:PROFile:AUTO:PUCCh:OS
[[:SENSe]:EVM:ULINK:PROFile:AUTO:PUCCh:PWRBoost
[[:SENSe]:EVM:ULINK:PROFile:AUTO:PUCCh:RB
[[:SENSe]:EVM:ULINK:PROFile:AUTO:PUCCh:SHIFt
[[:SENSe]:EVM:ULINK:PROFile:AUTO:PUCCh:SSLot
[[:SENSe]:EVM:ULINK:PROFile:AUTO:PUCCh:SSLot:AUTO
[[:SENSe]:EVM:ULINK:PROFile:AUTO:PUSCh:ACTive
[[:SENSe]:EVM:ULINK:PROFile:AUTO:PUSCh:DMRS:CSHift
[[:SENSe]:EVM:ULINK:PROFile:AUTO:PUSCh:DMRS:GROup
[[:SENSe]:EVM:ULINK:PROFile:AUTO:PUSCh:DMRS:ONE
[[:SENSe]:EVM:ULINK:PROFile:AUTO:PUSCh:DMRS:PARams
[[:SENSe]:EVM:ULINK:PROFile:AUTO:PUSCh:DMRS:PWRBoost
[[:SENSe]:EVM:ULINK:PROFile:AUTO:PUSCh:DMRS:SEQuence
[[:SENSe]:EVM:ULINK:PROFile:AUTO:PUSCh:DMRS:TWO
[[:SENSe]:EVM:ULINK:PROFile:AUTO:PUSCh:DSS
[[:SENSe]:EVM:ULINK:PROFile:AUTO:PUSCh:FHOPping
[[:SENSe]:EVM:ULINK:PROFile:AUTO:PUSCh:MODulation:TYPE
[[:SENSe]:EVM:ULINK:PROFile:AUTO:PUSCh:NRBHo
[[:SENSe]:EVM:ULINK:PROFile:AUTO:PUSCh:NSB
[[:SENSe]:EVM:ULINK:PROFile:AUTO:PUSCh:PWRBoost
[[:SENSe]:EVM:ULINK:PROFile:AUTO:PUSCh:RB:END
[[:SENSe]:EVM:ULINK:PROFile:AUTO:PUSCh:RB:STARt
[[:SENSe]:EVM:ULINK:PROFile:AUTO:PUSCh:SSLot
[[:SENSe]:EVM:ULINK:PROFile:AUTO:PUSCh:SSLot:AUTO
[[:SENSe]:EVM:ULINK:PROFile:AUTO:SRS:ACTive
[[:SENSe]:EVM:ULINK:PROFile:AUTO:SRS:BCONfig
[[:SENSe]:EVM:ULINK:PROFile:AUTO:SRS:BWIDth
[[:SENSe]:EVM:ULINK:PROFile:AUTO:SRS:CINdex
[[:SENSe]:EVM:ULINK:PROFile:AUTO:SRS:CSHift
[[:SENSe]:EVM:ULINK:PROFile:AUTO:SRS:FDPosition

LTE Modulation Analysis Measurement
Meas Setup (Measurement Setup)

[[:SENSe]:EVM:ULINK:PROFile:AUTO:SRS:HBWidth
[[:SENSe]:EVM:ULINK:PROFile:AUTO:SRS:MUPTs
[[:SENSe]:EVM:ULINK:PROFile:AUTO:SRS:PWRBoost
[[:SENSe]:EVM:ULINK:PROFile:AUTO:SRS:SFConfig
[[:SENSe]:EVM:ULINK:PROFile:AUTO:SRS:SSLot
[[:SENSe]:EVM:ULINK:PROFile:AUTO:SRS:SSLot:AUTO
[[:SENSe]:EVM:ULINK:PROFile:AUTO:SRS:TCOMb
[[:SENSe]:EVM:ULINK:PROFile:USER(1:50):CID
[[:SENSe]:EVM:ULINK:PROFile:USER(1:50):DELete
[[:SENSe]:EVM:ULINK:PROFile:USER(1:50):HOPPing:GROup
[[:SENSe]:EVM:ULINK:PROFile:USER(1:50):HOPPing:SEQuence
[[:SENSe]:EVM:ULINK:PROFile:USER(1:50):RNTI
[[:SENSe]:EVM:ULINK:PROFile:USER(1:50):SFNumber
[[:SENSe]:EVM:ULINK:PROFile:USER(1:50):PRACH:ACTive
[[:SENSe]:EVM:ULINK:PROFile:USER(1:50):PRACH:CINdex
[[:SENSe]:EVM:ULINK:PROFile:USER(1:50):PRACH:CSSet
[[:SENSe]:EVM:ULINK:PROFile:USER(1:50):PRACH:PINdex
[[:SENSe]:EVM:ULINK:PROFile:USER(1:50):PRACH:LRsindex
[[:SENSe]:EVM:ULINK:PROFile:USER(1:50):PRACH:NCSConfig
[[:SENSe]:EVM:ULINK:PROFile:USER(1:50):PRACH:NRAPrb
[[:SENSe]:EVM:ULINK:PROFile:USER(1:50):PRACH:PWRBoost
[[:SENSe]:EVM:ULINK:PROFile:USER(1:50):PRACH:SRESource
[[:SENSe]:EVM:ULINK:PROFile:USER(1:50):PUCCh:ACTive
[[:SENSe]:EVM:ULINK:PROFile:USER(1:50):PUCCh:ADD:SLOT
[[:SENSe]:EVM:ULINK:PROFile:USER(1:50):PUCCh:CSHift
[[:SENSe]:EVM:ULINK:PROFile:USER(1:50):PUCCh:CSHift:COUPle
[[:SENSe]:EVM:ULINK:PROFile:USER(1:50):PUCCh:DMRS:GROup
[[:SENSe]:EVM:ULINK:PROFile:USER(1:50):PUCCh:DMRS:GROup:COUPle
[[:SENSe]:EVM:ULINK:PROFile:USER(1:50):PUCCh:DMRS:PARams

[[:SENSe]:EVM:ULINK:PROFile:USER(1:50):PUCCh:DMRS:PWRBoost
[[:SENSe]:EVM:ULINK:PROFile:USER(1:50):PUCCh:DMRS:PWRBoost:COUPLE
[[:SENSe]:EVM:ULINK:PROFile:USER(1:50):PUCCh:FORMat
[[:SENSe]:EVM:ULINK:PROFile:USER(1:50):PUCCh:FORMat:COUPLE
[[:SENSe]:EVM:ULINK:PROFile:USER(1:50):PUCCh:N:ONE
[[:SENSe]:EVM:ULINK:PROFile:USER(1:50):PUCCh:N:TWO
[[:SENSe]:EVM:ULINK:PROFile:USER(1:50):PUCCh:NCS:ONE
[[:SENSe]:EVM:ULINK:PROFile:USER(1:50):PUCCh:NRB:TWO
[[:SENSe]:EVM:ULINK:PROFile:USER(1:50):PUCCh:OS
[[:SENSe]:EVM:ULINK:PROFile:USER(1:50):PUCCh:OS:COUPLE
[[:SENSe]:EVM:ULINK:PROFile:USER(1:50):PUCCh:PWRBoost
[[:SENSe]:EVM:ULINK:PROFile:USER(1:50):PUCCh:PWRBoost:COUPLE
[[:SENSe]:EVM:ULINK:PROFile:USER(1:50):PUCCh:RB
[[:SENSe]:EVM:ULINK:PROFile:USER(1:50):PUCCh:RB:COUPLE
[[:SENSe]:EVM:ULINK:PROFile:USER(1:50):PUCCh:SHIFt
[[:SENSe]:EVM:ULINK:PROFile:USER(1:50):PUCCh:SLOT(0:19):CSHift
[[:SENSe]:EVM:ULINK:PROFile:USER(1:50):PUCCh:SLOT(0:19):DELete
[[:SENSe]:EVM:ULINK:PROFile:USER(1:50):PUCCh:SLOT(0:19):DMRS:GROUp
[[:SENSe]:EVM:ULINK:PROFile:USER(1:50):PUCCh:SLOT(0:19):DMRS:PWRBoost
[[:SENSe]:EVM:ULINK:PROFile:USER(1:50):PUCCh:SLOT(0:19):FORMat
[[:SENSe]:EVM:ULINK:PROFile:USER(1:50):PUCCh:SLOT(0:19):OS
[[:SENSe]:EVM:ULINK:PROFile:USER(1:50):PUCCh:SLOT(0:19):PWRBoost
[[:SENSe]:EVM:ULINK:PROFile:USER(1:50):PUCCh:SLOT(0:19):RB
[[:SENSe]:EVM:ULINK:PROFile:USER(1:50):PUCCh:SSLot
[[:SENSe]:EVM:ULINK:PROFile:USER(1:50):PUCCh:SSLot:AUTO
[[:SENSe]:EVM:ULINK:PROFile:USER(1:50):PUSCh:ACTive
[[:SENSe]:EVM:ULINK:PROFile:USER(1:50):PUSCh:ADD:SLOT
[[:SENSe]:EVM:ULINK:PROFile:USER(1:50):PUSCh:CTNB
[[:SENSe]:EVM:ULINK:PROFile:USER(1:50):PUSCh:CTNB:COUPLE
[[:SENSe]:EVM:ULINK:PROFile:USER(1:50):PUSCh:DMRS:CSHift
[[:SENSe]:EVM:ULINK:PROFile:USER(1:50):PUSCh:DMRS:CSHift:COUPLE

LTE Modulation Analysis Measurement
Meas Setup (Measurement Setup)

[::SENSe]:EVM:ULINK:PROFile:USER(1:50):PUSCh:DMRS:GROup
[::SENSe]:EVM:ULINK:PROFile:USER(1:50):PUSCh:DMRS:GROup:COUPle
[::SENSe]:EVM:ULINK:PROFile:USER(1:50):PUSCh:DMRS:ONE
[::SENSe]:EVM:ULINK:PROFile:USER(1:50):PUSCh:DMRS:PARams
[::SENSe]:EVM:ULINK:PROFile:USER(1:50):PUSCh:DMRS:PWRBoost
[::SENSe]:EVM:ULINK:PROFile:USER(1:50):PUSCh:DMRS:PWRBoost:COUPle
[::SENSe]:EVM:ULINK:PROFile:USER(1:50):PUSCh:DMRS:SEQuence
[::SENSe]:EVM:ULINK:PROFile:USER(1:50):PUSCh:DMRS:SEQuence:COUPle
[::SENSe]:EVM:ULINK:PROFile:USER(1:50):PUSCh:DMRS:TWO
[::SENSe]:EVM:ULINK:PROFile:USER(1:50):PUSCh:DSS
[::SENSe]:EVM:ULINK:PROFile:USER(1:50):PUSCh:FHOPping
[::SENSe]:EVM:ULINK:PROFile:USER(1:50):PUSCh:MODulation:TYPE
[::SENSe]:EVM:ULINK:PROFile:USER(1:50):PUSCh:MODulation:TYPE:COUPle
[::SENSe]:EVM:ULINK:PROFile:USER(1:50):PUSCh:NRBHo
[::SENSe]:EVM:ULINK:PROFile:USER(1:50):PUSCh:NSB
[::SENSe]:EVM:ULINK:PROFile:USER(1:50):PUSCh:PWRBoost
[::SENSe]:EVM:ULINK:PROFile:USER(1:50):PUSCh:PWRBoost:COUPle
[::SENSe]:EVM:ULINK:PROFile:USER(1:50):PUSCh:RB:END
[::SENSe]:EVM:ULINK:PROFile:USER(1:50):PUSCh:RB:END:COUPle
[::SENSe]:EVM:ULINK:PROFile:USER(1:50):PUSCh:RB:STARt
[::SENSe]:EVM:ULINK:PROFile:USER(1:50):PUSCh:RB:STARt:COUPle
[::SENSe]:EVM:ULINK:PROFile:USER(1:50):PUSCh:SLOT(0:19):CTNB
[::SENSe]:EVM:ULINK:PROFile:USER(1:50):PUSCh:SLOT(0:19):DELete
[::SENSe]:EVM:ULINK:PROFile:USER(1:50):PUSCh:SLOT(0:19):DMRS:CSHift
[::SENSe]:EVM:ULINK:PROFile:USER(1:50):PUSCh:SLOT(0:19):DMRS:GROup
[::SENSe]:EVM:ULINK:PROFile:USER(1:50):PUSCh:SLOT(0:19):DMRS:PWRBoost
[::SENSe]:EVM:ULINK:PROFile:USER(1:50):PUSCh:SLOT(0:19):DMRS:SEQuence
d
[::SENSe]:EVM:ULINK:PROFile:USER(1:50):PUSCh:SLOT(0:19):MODulation:TYPE
[::SENSe]:EVM:ULINK:PROFile:USER(1:50):PUSCh:SLOT(0:19):PWRBoost
[::SENSe]:EVM:ULINK:PROFile:USER(1:50):PUSCh:SLOT(0:19):RB:END
[::SENSe]:EVM:ULINK:PROFile:USER(1:50):PUSCh:SLOT(0:19):RB:STARt

[[:SENSe]:EVM:ULINK:PROFile:USER(1:50):PUSCh:SSLot
[[:SENSe]:EVM:ULINK:PROFile:USER(1:50):PUSCh:SSLot:AUTO
[[:SENSe]:EVM:ULINK:PROFile:USER(1:50):SRS:ACTive
[[:SENSe]:EVM:ULINK:PROFile:USER(1:50):SRS:BCONfig
[[:SENSe]:EVM:ULINK:PROFile:USER(1:50):SRS:BWIDth
[[:SENSe]:EVM:ULINK:PROFile:USER(1:50):SRS:CINDeX
[[:SENSe]:EVM:ULINK:PROFile:USER(1:50):SRS:CSHift
[[:SENSe]:EVM:ULINK:PROFile:USER(1:50):SRS:FDPosition
[[:SENSe]:EVM:ULINK:PROFile:USER(1:50):SRS:HBWidth
[[:SENSe]:EVM:ULINK:PROFile:USER(1:50):SRS:MUPTs
[[:SENSe]:EVM:ULINK:PROFile:USER(1:50):SRS:PWRBoost
[[:SENSe]:EVM:ULINK:PROFile:USER(1:50):SRS:SFCOnfig
[[:SENSe]:EVM:ULINK:PROFile:USER(1:50):SRS:SSLot
[[:SENSe]:EVM:ULINK:PROFile:USER(1:50):SRS:SSLot:AUTO
[[:SENSe]:EVM:ULINK:PROFile:USER(1:50):SRS:TCOMb

This feature supports the following operations:

- “[Update Changes \(Uplink\)](#)” on page 1124 command, which applies pending changes to parameters.
- “[Ignore Changes \(Uplink\)](#)” on page 1124 Ignore Changes command, which discards pending changes to parameters.
- “[Clear Changes \(Uplink\)](#)” on page 1124 command, which clears all existing RB mapping information for uplink.

The Update Changes and Ignore Changes commands behave similarly to the OK and Cancel buttons on user interface dialogs, respectively.

For example, to clear existing RB mapping information and configure one user with one PUSCH slot with RB End set to 49, send the following sequence in order. Note that the Clear Changes command is not required just after mode preset since there is no RB mapping information by default.

```
[[:SENSe]:EVM:ULINK:PROFile:ADD:USER
[:SENSe]:EVM:ULINK:PROFile:USER1:PUSCh:ADD:SLOT
[:SENSe]:EVM:ULINK:PROFile:USER1:PUSCh:RB:END 49
[:SENSe]:EVM:ULINK:PROFile:UPDate
```

LTE Modulation Analysis Measurement Meas Setup (Measurement Setup)

Update Changes (Uplink)

SCPI Only. This command updates changes sent after last UPDATE or preset.

Mode	LTE, LTETDD
Remote Command	[:SENSE] : EVM : ULINK : PROFILE : UPDATE
Example	EVM:ULIN:PROF:UPD
Initial S/W Revision	A.03.00

Clear Changes (Uplink)

SCPI Only. This command clears allocated resource blocks and delete all Users

Mode	LTE, LTETDD
Remote Command	[:SENSE] : EVM : ULINK : PROFILE : CLEAR
Example	EVM:ULIN:PROF:CLE
Initial S/W Revision	A.03.00

Ignore Changes (Uplink)

SCPI Only. This command ignores (clears) changes that are not updated.

Mode	LTE, LTETDD
Remote Command	[:SENSE] : EVM : ULINK : PROFILE : IGNORE
Example	EVM:ULIN:PROF:IGN
Initial S/W Revision	A.03.00

Count Number of Users (Uplink)

SCPI Only. This command returns the number of added users.

Mode	LTE, LTETDD
Remote Command	[:SENSE] : EVM : ULINK : PROFILE : COUNT?
Example	EVM:ULIN:PROF:COUN?
Initial S/W Revision	A.03.00

Count Number of PUCCH Slots (Uplink)

SCPI Only. This command returns the number of added PUCCH slots.

Mode	LTE, LTETDD
Remote Command	[:SENSE] : EVM : ULINK : PROFILE : USER<n> : PUCCH : COUNT?
Example	EVM:ULIN:PROF:USER2:PUCCH:COUN?

Dependencies	The range of sub op code <n> values is determined by the number of Users the user has configured. If the user attempts to remotely set or query a sub op code that is out of range, this will result in an error message.
Initial S/W Revision	A.03.00

Count Number of PUSCH Slots (Uplink)

SCPI Only. This command returns the number of added PUSCH slots.

Mode	LTE, LTETDD
Remote Command	[:SENSe] :EVM:ULINk:PROFile:USER<n>:PUSCh:COUNT?
Example	EVM:ULIN:PROF:USER2:PUSC:COUN?
Dependencies	The range of sub op code <n> values is determined by the number of Users the user has configured. If the user attempts to remotely set or query a sub op code that is out of range, this will result in an error message.
Initial S/W Revision	A.03.00

Copy Auto -> Manual

See [“Copy Auto -> Manual” on page 974.](#)

Key Path	Meas Setup, Chan Profile Setup
----------	---------------------------------------

Decode

Displays a menu that enables you to configure RA-RNTI and TPC-RNTI search ranges and what level of decoding to perform on PBCH, PCFICH, PDCCH, PDSCH, and PUSCH.

Key Path	Meas Setup
Initial S/W Revision	A.06.00

Decode Type

Displays a menu that enables you to select the decoding type of each channel. The decoded symbols will be displayed in the Decoded Symbol Table.

Key Path	Meas Setup, Decode
Initial S/W Revision	A.06.00

PBCH Decoding

Selects the decoding type of the PBCH. It specifies how much coding to undo before showing the Master Information Block (MIB) bits from PBCH on the Decoded Symbol Table. See 3GPP TS 36.212, Section

5.3.1 for a diagram of the coding operations performed on PBCH.

The following is a list of the available PBCH decoding type selections and the resulting bits:

- NONE – None, no bits for this channel will be shown on the Decoded Symbol Table.
- DESCrambled – Descrambled, 480 (Normal CP) or 432 (Extended CP) descrambled (rate-matched) bits for each subframe 0 in a frame
- DRMatched – DeRateMatched, 120 deratematched (channel coded) bits for each subframe 0 in a frame
- DECoded – 40 (information bits + CRC) bits for each subframe 0 in a frame

NOTE

The PBCH decoder is On when PBCH Decoding is not set to None or when PHICH Duration or PHICH Allocation (Ng) are set to Auto Detect.

Key Path	Meas Setup, Decode, Decode Type
Mode	LTE, LTETDD
Remote Command	[:SENSE] :EVM:DLINK:DECode:PBCH NONE DESCrambled DRMatched DECoded [:SENSE] :EVM:DLINK:DECode:PBCH?
Example	EVM:DLIN:DEC:PBCH NONE EVM:DLIN:DEC:PBCH?
Notes	Available when Direction is Downlink.
State Saved	Saved in instrument state.
Range	None Descrambled DeRateMatched Decoded
Initial S/W Revision	A.06.00

PCFICH Decoding

Selects the decoding type of the PCFICH. It specifies how much coding to undo before showing the bits from PCFICH on the Decoded Symbol Table. See 3GPP TS 36.212, Section 5.3.4 for a diagram of the coding operations performed to PCFICH.

The following is a list of the available PCFICH decoding type selections and the resulting bits:

- NONE – None, no bits for this channel will be shown on the Decoded Symbol Table.
- DESCrambled – Descrambled, 32 descrambled (channel coded) bits per subframe
- DECoded – Decoded, 2 decoded bits (CFI) per subframe

NOTE

The PCFICH decoder is On when PCFICH Decoding is not set to None or when

PDCCH Allocation Auto Detect is set to On.

Key Path	Meas Setup, Decode, Decode Type
Mode	LTE, LTETDD
Remote Command	[:SENSE] :EVM:DLINK:DECode:PCFich NONE DESCrambled DECode [:SENSE] :EVM:DLINK:DECode:PCFich?
Example	EVM:DLIN:DEC:PCF NONE EVM:DLIN:DEC:PCF?
Notes	Available when Direction is Downlink.
State Saved	Saved in instrument state.
Range	None Descrambled Decoded
Initial S/W Revision	A.06.00

PDCCH Decoding

Selects the decoding type of the PDCCH. It specifies how much coding to undo before showing the bits from PDCCH on the Decoded Symbol Table. See 3GPP TS 36.212, Section 5.3.1 for a diagram of the coding operations performed on PDCCH.

The following is a list of the available PDCCH decoding type selections and the resulting bits. N_{REG} is the number of resource element groups not allocated for PHICH or PCFICH in a subframe.

- NONE – None, no PDCCH bits will be shown in the Decoded Symbol Table.
- DEMapped – Demapped, $N_{REG} * 8$ demapped (interleaved) DCI format bits for each subframe
- DINterleaved – Deinterleaved, $N_{REG} * 8$ deinterleaved (scrambled) DCI format bits for each subframe
- DESCrambled – Descrambled, $N_{REG} * 8$ descrambled (rate-matched) bits for each subframe
- DRMatched – DeRateMatched, $\Sigma (8 + LEN_i)$ bits for each subframe
 Each set of bits for an active PDCCH transmission consists of an 8-bit length field (LEN_i) followed by the deratematched (channel coded) bits.
 LEN_i indicates the number of deratematched bits for the i th PDCCH transmission in a subframe and can be used to determine where a PDCCH ends and the next PDCCH begins in the Decoded Symbol Table.
 $LEN_i = 3 * (\text{DCI Payload Length} + \text{CRC Length})$
- DECodeD – Decoded, $\Sigma (8 + LEN_i)$ bits for each subframe
 Each set of bits for an active PDCCH transmission consists of an 8-bit length field (LEN_i), the decoded (DCI payload + CRC) bits, and the 16-bit CRC.
 LEN_i indicates the number of decoded bits (including CRC) for the i th PDCCH transmission in a subframe and can be used to determine where a PDCCH ends and the next PDCCH begins in the

Decoded Symbol Table.
 $LEN_i = DCI \text{ Payload Length} + CRC \text{ Length}$

NOTE For both Deratematched and Decoded PDCCH bits, the analyzer auto-detects the number of active PDCCH transmitted within each subframe, nPDCCH. The PDCCH decoder is On when RB Auto Detect Mode is set to Decode PDCCH or when PDCCH Decoding is not set to None.

Key Path	Meas Setup, Decode, Decode Type
Mode	LTE, LTETDD
Remote Command	[:SENSE] : EVM : DLINK : DECODE : PDCCh NONE DEMapped DINTERleaved DESCrambled DRMatched DECODE d [:SENSE] : EVM : DLINK : DECODE : PDCCh?
Example	EVM:DLIN:DEC:PDCC NONE EVM:DLIN:DEC:PDCC?
Notes	Available when Direction is Downlink.
State Saved	Saved in instrument state.
Range	None Demapped Deinterleaved Descrambled DeRateMatched Decoded
Initial S/W Revision	A.06.00

PDSCH Decoding

Selects the decoding type of the PDSCH. It specifies how much coding to undo before showing the bits from PDSCH on the Decoded Symbol Table. See 3GPP TS 36.212, Section 5.3.2 for a diagram of the coding operations performed on PDSCH. The following is a list of the available PDSCH decoding type selections and the resulting bits:

- NONE - None, no bits for this channel will be shown on the Decoded Symbol Table.
- DESCrambled - Descrambled, descrambled (rate-matched) bits for each subframe
- DRMatched – DeRateMatched, $\Sigma (16 + LEN_i)$ bits per subframe
 Each set of bits for a PDSCH transmission consists of an 16-bit length field (LEN_i) followed by the deratematched (channel coded) bits.
 LEN_i indicates the number of deratematched bits for the i^{th} PDSCH allocation in a subframe and can be used to determine where one set of deratematched bits ends and the next set begins in the Decoded Symbol Table.
 $LEN_i = 3 * (\text{Codeblock Length} + CRC \text{ Length} + \text{Trellis Termination Bit Length})$ where Trellis Termination Bit Length = 4.
- DCBLoK – Decoded CB, $\Sigma (16 + LEN_i)$ bits per subframe

Each set of bits for a PDSCH codeblock consists of a 16-bit length field (LEN_i), the decoded codeblock bits, and a 24-bit CRC. When codeblock segmentation is not performed (Transport Block Size (TBS(n)) is less than 6144), the codeblock + CRC bits shown are the same as the transport block + CRC bits.

LEN_i indicates the number of decoded bits (including CRC) for the i^{th} PDSCH codeblock in a subframe and can be used to determine where a set of codeblock bits ends and the next set begins in the Decoded Symbol Table.

- **DTBLock** – Decoded TB, Σ (Transport Block Sizes + 24) decoded transport block bits (including CRCs) per subframe
 Each set of bits consists of the decoded transport block bits followed by a 24-bit CRC. There is no LEN field for decoded transport block bits since the Transport Block Size for each PDSCH allocation is shown on the DL Decode Info table in the TBS(n) data result.

NOTE The PDSCH decoder is On when PDSCH Decoding is not set to None.

Key Path	Meas Setup, Decode, Decode Type
Mode	LTE, LTETDD
Remote Command	[:SENSE] :EVM:DLINk:DECode:PDSCh NONE DESCrambled DRMatched DCBLock DTBLock [:SENSE] :EVM:DLINk:DECode:PDSCh?
Example	EVM:DLIN:DEC:PDSC NONE EVM:DLIN:DEC:PDSC?
Dependencies	Available when Direction is Downlink. Available when Detection is Auto and RB Auto Detect Mode is Decoded PDCCH.
State Saved	Saved in instrument state.
Range	None DESCrambled DeRateMatched Decoded Code Block Decoded Tx Port Block
Initial S/W Revision	A.06.00

PUSCH Decoding

Selects the decoding type of the PUSCH. It determines the level of decoding for PUSCH bits shown in the Decoded Symbol Table.

- **NONE** - None, no decoding is performed on PUCCH bits. Mapped bits are shown in the Symbol Table.
- **DESCrambled** – Descrambled, descrambled (rate-matched) bits for each subframe are shown in the Decoded Symbol Table.
- **DRMatched** – DeRateMatched, Σ (16 + LEN_i) bits per subframe.

LTE Modulation Analysis Measurement
Meas Setup (Measurement Setup)

Each set of bits for a PUSCH transmission consists of a 16-bit length field (LEN_i) followed by the deratematched (channel coded) bits for each codeblock.

LEN_i indicates the number of deratematched bits for the ith codeblock in a subframe and can be used to determine where one set of deratematched codeblock bits ends and the next set begins in the Decoded Symbol Table.

$LEN = 3 * (\text{Codeblock Length} + \text{CRC Length} + \text{Trellis Termination Bit Length})$ bits, where Codeblock Length is transmission dependent, CRC Length = 24 bits, and Trellis Termination Bit Length = 4 bits.

- DCBBlock – Decoded CB, $\Sigma (16 + LEN_i)$ bits per subframe.
 Each set of bits for a PUSCH codeblock consists of a 16-bit length field (LEN), the decoded codeblock bits, and a 24-bit CRC. When codeblock segmentation is not performed (Transport Block Size (TBS(n)) is less than 6144), the codeblock + CRC bits shown are the same as the transport block + CRC bits.
 LEN_i indicates the number of decoded bits (including CRC) for the ith codeblock in a subframe and can be used to determine where a set of codeblock bits ends and the next set begins in the Decoded Symbol Table. $LEN_i = \text{Codeblock Length} + \text{CRC Length}$, where Codeblock Length is transmission dependent, and CRC Length = 24 bits.
- DTBBlock – Decoded TB, (Transport Block Size + 24) decoded transport block bits (including CRCs) per subframe.
 The number of bits shown on the Decoded Symbol Table for a PUSCH channel allocation when PUSCH Bits is set to Decoded is equal to the sum of the Size metrics (HARQ Size, CQI/PMI Size, SR Size, etc.) plus the Transport Block Size (TBS) for the corresponding decoded PUSCH allocation listed in the UL Decode Info trace.

NOTE RNTI needs to be specified for a user allocation for PUSCH descrambling to be performed.

Key Path	Meas Setup, Decode, Decode Type
Mode	LTE, LTETDD
Remote Command	[:SENSE] :EVM:ULINK:DECode:PUSCh NONE DESCrambled DRMatched DCBBlock DTBBlock [:SENSE] :EVM:ULINK:DECode:PUSCh?
Example	EVM:ULIN:DEC:PUSC NONE EVM:ULIN:DEC:PUSC?
Notes	Available when Direction is Uplink. RNTI needs to be specified for a user allocation in the LTE Allocation Editor for PUSCH descrambling to be performed.
State Saved	Saved in instrument state.
Range	None Descrambled DeRatematched Decoded Code Block Decoded Tx Port Block

Initial S/W Revision	A.06.00
Modified at S/W Revision	A.10.00

PUCCH Decoding

Selects the decoding type of the PUCCH. It determines how much coding to undo before showing the bits from PUCCH on the Decoded Symbol Table. See 3GPP TS 36.212, Section 5.2.3 for a diagram of the coding operations performed on PUCCH.

- NONE - None, raw PUCCH bits are mapped to resource element locations and shown in the Symbol Table. No PUCCH bits are shown in the Decoded Symbol Table.
- DESCrambled –Descrambled, descrambled (channel coded) bits for each subframe are shown on the Decoded Symbol Table.
- DECodeD – Decoded, decoded bits for each subframe are shown in the Decoded Symbol Table.

NOTE For PUCCH Format 2/2a/2b, where both CQI/PMI and HARQ-ACK bits are jointly encoded, CQI/PMI information bits are listed first in a set of PUCCH bits, followed by HARQ-ACK information bits.

Key Path	Meas Setup, Decode, Decode Type
Mode	LTE, LTETDD
Remote Command	[:SENSE] :EVM:ULINk:DECode:PUCCh NONE DESCrambled DECodeD [:SENSE] :EVM:ULINk:DECode:PUCCh?
Example	EVM:ULIN:DEC:PUC NONE EVM:ULIN:DEC:PUC?
Notes	Available when Direction is Uplink.
State Saved	Saved in instrument state.
Range	None Descrambled Decoded
Initial S/W Revision	A.10.00

DCI Format Detection Include

Configures how the demodulator detects DCI formats 1, 1B, and 1D.

The analyzer uses the number of the PDCCH message payload bits to determine the DCI format used in a PDCCH. DCI formats 1B and 1D always have equal lengths. In some cases, message payload length for DCI format 1 can be the same length as 1B and 1D. To specify which DCI formats to look for, the analyzer provides the following settings for the DCI Formats 1, 1B, 1D Detection Include parameter.

- F1F1B - Formats 1 and 1B, the analyzer assumes format 1D is not present. When frame configuration

LTE Modulation Analysis Measurement
Meas Setup (Measurement Setup)

enables format 1 to have the same length as format 1B, all DCI message payloads of this length are decoded as format 1. Otherwise, formats 1 and 1B are decoded separately.

- F1FD - Formats 1 and 1D, the analyzer assumes format 1B is not present. When frame configuration enables format 1 to have the same length as format 1D, all DCI message payloads of this length are decoded as format 1. Otherwise, formats 1 and 1D are decoded separately.
- F1 - Format 1 only, the analyzer assumes that formats 1B and 1D are not present. Format 1B or 1D message payloads are decoded as format 1 when possible format 1 message payload lengths include the format 1B/1D payload length. Otherwise, format 1B or 1D message payloads are ignored.
- F1B - Format 1B only, the analyzer assumes that formats 1 and 1D are not present. Any message payloads with the length of a format 1B payload are decoded as format 1B.
- F1D - Format 1D only, the analyzer assumes that formats 1 and 1B are not present. Any message payloads with the length of a format 1D payload are decoded as format 1D.

Key Path	Meas Setup, Decode
Mode	LTE, LTETDD
Remote Command	[:SENSE] :EVM:DLINK:DECODE:DFINCLUDE F1F1B F1F1D F1 F1B F1D [:SENSE] :EVM:DLINK:DECODE:DFINCLUDE?
Example	EVM:DLIN:DEC:DFIN F1F1B EVM:DLIN:DEC:DFIN?
Dependencies	Available when Direction is Downlink.
Preset	F1F1B
State Saved	Saved in instrument state.
Range	Formats1 and 1B Formats1 and 1D Format1 only Format1B only Format1D only
Initial S/W Revision	A.06.00

RNTI Range

Specifies the range of RNTI values for PDCCH transmissions that will be used as Random Access RNTIs (=RA-RNTI) or Transmit Power Control RNTIs (=TPC-RNTI) for decoding purposes. This parameter is available when Direction is Downlink.

Key Path	Meas Setup, Decode
Initial S/W Revision	A.06.00

RA-RNTI Range Min Value

Sets the minimum value of the RA-RNTI range.

RA-RNTI Range specifies the range of RNTI values that are assumed to be RA-RNTIs when decoding PDCCH transmissions. This parameter is needed to unambiguously decode the contents of DCI Format 1A.

NOTE Zero is not a valid RA-RNTI value, but is used to indicate that there are no RA-RNTI contained in the LTE signal when both the Min and Max values are set to 0.

Any PDCCH whose CRC is scrambled with an RNTI that is not contained in either the RA-RNTI or TPC-RNTI ranges and cannot be determined to be a SI-RNTI or P-RNTI will be demodulated as a C-RNTI PDCCH.

Key Path	Meas Setup, Decode, RNTI Range
Mode	LTE, LTETDD
Remote Command	[:SENSE] :EVM:DLINk:DECode:RNTI:MINimum:RA <integer> [:SENSE] :EVM:DLINk:DECode:RNTI:MINimum:RA?
Example	EVM:DLIN:DEC:RNTI:MIN:RA 0 EVM:DLIN:DEC:RNTI:MIN:RA?
Notes	The value should be less than or equal to RA-RNTI Range Max Value.
Dependencies	Available when Direction is Downlink.
Preset	0
State Saved	Saved in instrument state.
Min	0
Max	60
Initial S/W Revision	A.06.00

RA-RNTI Range Max Value

Sets the maximum value of the RA-RNTI range.

RA-RNTI Range specifies the range of RNTI values that are assumed to be RA-RNTIs when decoding PDCCH transmissions. This parameter is needed to unambiguously decode the contents of DCI Format 1A.

NOTE Zero is not a valid RA-RNTI value, but is used to indicate that there are no RA-RNTI contained in the LTE signal when both the Min and Max values are set to 0.

Any PDCCH whose CRC is scrambled with an RNTI that is not contained in either the RA-RNTI or TPC-RNTI ranges and cannot be determined to be a SI-RNTI or P-RNTI will be demodulated as a C-RNTI PDCCH.

LTE Modulation Analysis Measurement
Meas Setup (Measurement Setup)

Key Path	Meas Setup, Decode, RNTI Range
Mode	LTE, LTETDD
Remote Command	[:SENSE] :EVM:DLINK:DECODE:RNTI:MAXimum:RA <integer> [:SENSE] :EVM:DLINK:DECODE:RNTI:MAXimum:RA?
Example	EVM:DLIN:DEC:RNTI:MAX:RA 0 EVM:DLIN:DEC:RNTI:MAX:RA?
Notes	The value should be greater than or equal to the RA-RNTI Range Min Value.
Dependencies	Available only when Direction is Downlink.
Preset	0
State Saved	Saved in instrument state.
Min	0
Max	60
Initial S/W Revision	A.06.00

TPC-RNTI Range Min Value

Sets the minimum value of the TPC-RNTI range.

TPC-RNTI Range specifies the range of RNTI values that are assumed to be TPC-RNTIs when decoding PDCCH transmissions.

DCI Formats 3 and 3A have the same message payload size as DCI Formats 0 and 1A. Any PDCCHs with a RNTI falling within the specified TPC-RNTI Range will be decoded as DCI Format 3/3A transmit power control commands.

NOTE Any PDCCH whose CRC is scrambled with an RNTI that is not contained in either the RA-RNTI or TPC-RNTI ranges and cannot be determined to be a SI-RNTI or P-RNTI will be demodulated as a C-RNTI PDCCH.

Key Path	Meas Setup, Decode, RNTI Range
Mode	LTE, LTETDD
Remote Command	[:SENSE] :EVM:DLINK:DECODE:RNTI:MINimum:TPC <integer> [:SENSE] :EVM:DLINK:DECODE:RNTI:MINimum:TPC?
Example	EVM:DLIN:DEC:RNTI:MIN:TPC 0 EVM:DLIN:DEC:RNTI:MIN:TPC?
Notes	The value should be less than or equal to TPC-RNTI Range Max Value.

Dependencies	Available only when Direction is Downlink.
Preset	0
State Saved	Saved in instrument state.
Min	0
Max	65523
Initial S/W Revision	A.06.00

TPC-RNTI Range Max Value

Sets the maximum value of the TPC-RNTI range.

TPC-RNTI Range specifies the range of RNTI values that are assumed to be TPC-RNTIs when decoding PDCCH transmissions.

DCI Formats 3 and 3A have the same message payload size as DCI Formats 0 and 1A. Any PDCCHs with a RNTI falling within the specified TPC-RNTI Range will be decoded as DCI Format 3/3A transmit power control commands.

NOTE Any PDCCH whose CRC is scrambled with an RNTI that is not contained in either the RA-RNTI or TPC-RNTI ranges and cannot be determined to be a SI-RNTI or P-RNTI will be demodulated as a C-RNTI PDCCH.

Key Path	Meas Setup, Decode, RNTI Range
Mode	LTE, LTETDD
Remote Command	[:SENSe] :EVM:DLINk:DECode:RNTI:MAXimum:TPC <integer> [:SENSe] :EVM:DLINk:DECode:RNTI:MAXimum:TPC?
Example	EVM:DLIN:DEC:RNTI:MAX:TPC 0 EVM:DLIN:DEC:RNTI:MAX:TPC?
Notes	The value should be greater than or equal to the TPC-RNTI Range Min Value.
Dependencies	Available only when Direction is Downlink.
Preset	0
State Saved	Saved in instrument state.
Min	0
Max	65523
Initial S/W Revision	A.06.00

DCI Format 2 PMI Config

Displays a menu that enables you to specify the latest Precoding Matrix Indicator(s) (PMI) reported by the UE. The latest PMI report can be specified for PDSCH allocations using 1, 2, 3, or 4 layers. Valid PMI reports are shown in the table below:

Num. of Layers	2 Tx Antenna Ports	4 Tx Antenna Ports
1	0–3	0–15
2	0–1	0–15
3	n/a	0–15
4	n/a	0–15

When Format 2 DCI is used to specify PDSCH RB allocations for a user, the eNodeB can explicitly specify the precoding that was applied to the PDSCH allocations, or can indicate that the last PMI report from the UE was used. In the latter case, the LTE demodulator needs to know what PMI that the UE reported to be able to completely decode the contents of the DCI payload as well as decode the corresponding PDSCH user allocation.

More information about DCI Format 2 can be found in 3GPP TS 36.211, Section 5.3.3.1.5.

Key Path	Meas Setup, Decode,
Mode	LTE, LTETDD
Initial S/W Revision	A.10.00

Latest PMI Report on PUSCH using 1 Layer

Specifies the latest Precoding Matrix Indicator(s) (PMI) reported by the UE.

Key Path	Meas Setup, Decode, DCI Format 2 PMI Config
Mode	LTE, LTETDD
Remote Command	[:SENSE]:EVM:DLINK:DECode:DFTWo:PRONe <integer> [:SENSE]:EVM:DLINK:DECode:DFTWo:PRONe?
Example	EVM:DLIN:DEC:DFTW:PRON 1 EVM:DLIN:DEC:DFTW:PRON?
Dependencies	Available when Direction is Downlink and Number of Tx Antenna is set to 2 or 4 Antennas. The number of valid PMI reports differs depending on the number of Tx Antenna. 2 Antennas: 0–3 4 Antennas: 0–15
Preset	0

State Saved	Saved in instrument state.
Min	0
Max	Depends on the number of Tx Antenna. 2 Antennas: 3 4 Antennas: 15
Initial S/W Revision	A.10.00

Latest PMI Report on PUSCH using 2 Layers

Specifies the latest Precoding Matrix Indicator(s) (PMI) reported by the UE.

Key Path	Meas Setup, Decode, DCI Format 2 PMI Config
Mode	LTE, LTETDD
Remote Command	[:SENSE] :EVM:DLINK:DECode:DFTWo:PRTWo <integer> [:SENSE] :EVM:DLINK:DECode:DFTWo:PRTWo?
Example	EVM:DLIN:DEC:DFTW:PRTW 1 EVM:DLIN:DEC:DFTW:PRTW?
Dependencies	Available when Direction is Downlink and Number of Tx Antenna is set to 2 or 4 Antennas. The number of valid PMI reports differs depending on Number of Tx Antenna. 2 Antennas: 0–1 4 Antennas: 0–15
Preset	0
State Saved	Saved in instrument state.
Min	0
Max	Depends on the number of Tx Antenna. 2 Antennas: 1 4 Antennas: 15
Initial S/W Revision	A.10.00

Latest PMI Report on PUSCH using 3 Layers

Specifies the latest Precoding Matrix Indicator(s) (PMI) reported by the UE.

Key Path	Meas Setup, Decode, DCI Format 2 PMI Config
Mode	LTE, LTETDD

LTE Modulation Analysis Measurement
Meas Setup (Measurement Setup)

Remote Command	[:SENSe] :EVM:DLINk:DECode:DFTWo:PRTHree <integer> [:SENSe] :EVM:DLINk:DECode:DFTWo:PRTHree?
Example	EVM:DLIN:DEC:DFTW:PRTH 1 EVM:DLIN:DEC:DFTW:PRTH?
Dependencies	Available when Direction is Downlink and Number of Tx Antenna is set to 4 Antennas. The number of valid PMI reports differs depending on Number of Tx Antenna.
Preset	0
State Saved	Saved in instrument state.
Min	0
Max	15
Initial S/W Revision	A.10.00

Latest PMI Report on PUSCH using 4 Layers

Specifies the latest Precoding Matrix Indicator(s) (PMI) reported by the UE.

Key Path	Meas Setup, Decode, DCI Format 2 PMI Config
Mode	LTE, LTETDD
Remote Command	[:SENSe] :EVM:DLINk:DECode:DFTWo:PRFour <integer> [:SENSe] :EVM:DLINk:DECode:DFTWo:PRFour?
Example	EVM:DLIN:DEC:DFTW:PRF 1 EVM:DLIN:DEC:DFTW:PRF?
Dependencies	Available when Direction is Downlink and Number of Tx Antenna is set to 4 Antennas.
Preset	0
State Saved	Saved in instrument state.
Min	0
Max	15
Initial S/W Revision	A.10.00

PUSCH Decode Parameters

Displays a menu that enables you to configure decoding of HARQ-ACK, RI, and CQI/PMI information bits.

Available when Direction is Uplink.

Info Size parameter

Specifies the number of bits for all PUSCH transmissions for the selected uplink user allocation.

When AutoDet is selected for HARQ-ACK, RI, or CQI/PMI, the corresponding information bit size will be auto detected as far as possible.

The possible range of information bits is listed as follows:

- HARQ-ACK bits range: 0–11 bits
- RI bits range: 0–2 bits
- CQI-PMI bits range: 0–128 bits

TIP: For best demodulation performance, specify Info Size manually.

Offset Index parameter

Specifies the value of Ioffset for HARQ-ACK, RI, and CQI in the tables listed in 3GPP TS 36.213, Section 8.6.3.

The possible range of Offset Index values are as follows:

- HARQ-ACK bits range: 0–14 bits
- RI bits range: 0–12 bits
- CQI-PMI bits range: 2–15 bits

Key Path	Meas Setup, Decode
Mode	LTE, LTETDD
Initial S/W Revision	A.10.00

PUSCH HARQ-ACK

Displays a menu that enables you to set the information size and offset index of PUSCH HARQ ACK/NACK.

Key Path	Meas Setup, Decode, PUSCH Decode Parameters
Mode	LTE, LTETDD
Initial S/W Revision	A.10.00

PUSCH HARQ-ACK Info Size

Specifies the HARQ-ACK informatin size in bits.

When AutoDet is selected, information size will be auto detected as far as possible.

TIP: For the best demodulation performance, specify Info Size manually.

Key Path	Meas Setup, Decode, PUSCH Decode Parameters, HARQ-ACK
Mode	LTE, LTETDD

LTE Modulation Analysis Measurement
Meas Setup (Measurement Setup)

Remote Command	[:SENSe] :EVM:ULINk:DECode:PUSCh:HARQ:ISIZe <integer> [:SENSe] :EVM:ULINk:DECode:PUSCh:HARQ:ISIZe? [:SENSe] :EVM:ULINk:DECode:PUSCh:HARQ:ISIZe:AUTO OFF ON 0 1 [:SENSe] :EVM:ULINk:DECode:PUSCh:HARQ:ISIZe:AUTO?
Example	EVM:ULIN:DEC:PUSC:HARQ:ISIZ 0 EVM:ULIN:DEC:PUSC:HARQ:ISIZ? EVM:ULIN:DEC:PUSC:HARQ:ISIZ:AUTO 0 EVM:ULIN:DEC:PUSC:HARQ:ISIZ:AUTO?
Dependencies	Available when Direction is Uplink and PUSCH HARQ-ACK Info Size Auto Detect is OFF.
Preset	0 ON
State Saved	Saved in instrument state.
Min	0
Max	11
Initial S/W Revision	A.10.00

PUSCH HARQ-ACK Offset Index

Specifies the value of I_{offset} for HARQ-ACK in the tables listed in 3GPP TS 36.213, Section 8.6.3.

Key Path	Meas Setup, Decode, PUSCH Decode Parameters, HARQ-ACK
Mode	LTE, LTETDD
Remote Command	[:SENSe] :EVM:ULINk:DECode:PUSCh:HARQ:OFFSet <integer> [:SENSe] :EVM:ULINk:DECode:PUSCh:HARQ:OFFSet?
Example	EVM:ULIN:DEC:PUSC:HARQ:OFFS 0 EVM:ULIN:DEC:PUSC:HARQ:OFFS?
Dependencies	Available when Direction is Uplink.
Preset	0
State Saved	Saved in instrument state.
Min	0
Max	14
Initial S/W Revision	A.10.00

PUSCH RI

Displays a menu that enables you to set the information size and offset index of PUSCH Rank Indicator.

Key Path	Meas Setup, Decode, PUSCH Decode Parameters
Mode	LTE, LTETDD
Initial S/W Revision	A.10.00

PUSCH RI Info Size

Specifies the RI informatin size in bits.

When AutoDet is selected, information size will be auto detected as far as possible.

TIP: For the best demodulation performance, specify Info Size manually.

Key Path	Meas Setup, Decode, PUSCH Decode Parameters, RI
Mode	LTE, LTETDD
Remote Command	[:SENSE] :EVM:ULINK:DECode:PUSCh:RI:ISIZe <integer> [:SENSE] :EVM:ULINK:DECode:PUSCh:RI:ISIZe? [:SENSE] :EVM:ULINK:DECode:PUSCh:RI:ISIZe:AUTO OFF ON 0 1 [:SENSE] :EVM:ULINK:DECode:PUSCh:RI:ISIZe:AUTO?
Example	EVM:ULIN:DEC:PUSC:RI:ISIZ 0 EVM:ULIN:DEC:PUSC:RI:ISIZ? EVM:ULIN:DEC:PUSC:RI:ISIZ:AUTO 1 EVM:ULIN:DEC:PUSC:RI:ISIZ:AUTO?
Dependencies	Available when Direction is Uplink and PUSCH RI Info Size Auto Detect is Off.
Preset	0 ON
State Saved	Saved in instrument state.
Min	0
Max	2
Initial S/W Revision	A.10.00

PUSCH RI Offset Index

Specifies the value of I_{offset} for RI in the tables listed in 3GPP TS 36.213, Section 8.6.3.

Key Path	Meas Setup, Decode, PUSCH Decode Parameters, RI
Mode	LTE, LTETDD

LTE Modulation Analysis Measurement
Meas Setup (Measurement Setup)

Remote Command	[:SENSe] :EVM:ULINk:DECode:PUSCh:RI:OFFSet <integer> [:SENSe] :EVM:ULINk:DECode:PUSCh:RI:OFFSet?
Example	EVM:ULIN:DEC:PUSC:RI:OFFS 1 EVM:ULIN:DEC:PUSC:RI:OFFS?
Dependencies	Available when Direction is Uplink.
Preset	0
State Saved	Saved in instrument state.
Min	0
Max	12
Initial S/W Revision	A.10.00

PUSCH CQI/PMI

Displays a menu that enables you to set the information size and offset index of PUSCH Channel Quality & Precoding Matrix Indicator.

Key Path	Meas Setup, Decode, PUSCH Decode Parameters
Mode	LTE, LTETDD
Initial S/W Revision	A.10.00

PUSCH CQI/PMI Info Size

Specifies the CQI/PMI information size in bits.

When AutoDet is selected, information size will be auto detected as far as possible.

TIP: For the best demodulation performance, specify Info Size manually.

Key Path	Meas Setup, Decode, PUSCH Decode Parameters, CQI/PMI
Mode	LTE, LTETDD
Remote Command	[:SENSe] :EVM:ULINk:DECode:PUSCh:CQI:ISIZe <integer> [:SENSe] :EVM:ULINk:DECode:PUSCh:CQI:ISIZe? [:SENSe] :EVM:ULINk:DECode:PUSCh:CQI:ISIZe:AUTO OFF ON 0 1 [:SENSe] :EVM:ULINk:DECode:PUSCh:CQI:ISIZe:AUTO?
Example	EVM:ULIN:DEC:PUSC:CQI:ISIZ 1 EVM:ULIN:DEC:PUSC:CQI:ISIZ? EVM:ULIN:DEC:PUSC:CQI:ISIZ:AUTO OFF EVM:ULIN:DEC:PUSC:CQI:ISIZ:AUTO?

Dependencies	Available when Direction is Uplink and PUSCH CQI/RI Info Size Auto Detect is Off.
Preset	0 ON
State Saved	Saved in instrument state.
Min	0
Max	128
Initial S/W Revision	A.10.00

PUSCH CQI/PMI Offset Index

Specifies the value of I_{offset} for CQI/PMI in the tables listed in 3GPP TS 36.213, Section 8.6.3.

Key Path	Meas Setup, Decode, PUSCH Decode Parameters, CQI/PMI
Mode	LTE, LTETDD
Remote Command	[:SENSE] :EVM:ULINk:DECode:PUSCh:CQI:OFFSet <integer> [:SENSE] :EVM:ULINk:DECode:PUSCh:CQI:OFFSet?
Example	EVM:ULIN:DEC:PUSC:CQI:OFFS 2 EVM:ULIN:DEC:PUSC:CQI:OFFS?
Preset	2
State Saved	Saved in instrument state.
Min	2
Max	15
Initial S/W Revision	A.10.00

PUCCH Decode Parameters

Displays a menu that enables you to configure decoding of HARQ-ACK and CQI/PMI information bits. The Info Size parameter specifies the number of bits for all PUCCH transmissions for the selected uplink user allocation.

Available when Direction is Uplink.

Info Size parameter

Specifies the number of bits for all PUCCH transmissions for the selected uplink user allocation.

When AutoDet is selected for HARQ-ACK or CQI/PMI, the corresponding information bit size will be auto detected as far as possible.

The possible range of information bits is listed as follows:

- HARQ-ACK bits range: 0–2 bits

LTE Modulation Analysis Measurement
Meas Setup (Measurement Setup)

- CQI-PMI bits range: 0–11 bits

TIP: For best demodulation performance, specify Info Size manually.

Key Path	Meas Setup, Decode
Mode	LTE, LTETDD
Initial S/W Revision	A.10.00

PUCCH HARQ-ACK

Displays a menu that enables you to set the of PUCCH HARQ ACK/NACK information size in bits.

Key Path	Meas Setup, Decode, PUCCH Decode Parameters
Mode	LTE, LTETDD
Initial S/W Revision	A.10.00

PUCCH HARQ-ACK Info Size

Specifies the HARQ-ACK information size in bits.

When AutoDet is selected, information size will be auto detected as far as possible.

TIP: For the best demodulation performance, specify Info Size manually.

Key Path	Meas Setup, Decode, PUCCH Decode Parameters, HARQ-ACK
Mode	LTE, LTETDD
Remote Command	[:SENSE] :EVM:ULINK:DECode:PUCCh:HARQ:ISIZe <integer> [:SENSE] :EVM:ULINK:DECode:PUCCh:HARQ:ISIZe? [:SENSE] :EVM:ULINK:DECode:PUCCh:HARQ:ISIZe:AUTO OFF ON 0 1 [:SENSE] :EVM:ULINK:DECode:PUCCh:HARQ:ISIZe:AUTO?
Example	EVM:ULIN:DEC:PUCC:HARQ:ISIZ 0 EVM:ULIN:DEC:PUCC:HARQ:ISIZ? EVM:ULIN:DEC:PUCC:HARQ:ISIZ:AUTO 0 EVM:ULIN:DEC:PUCC:HARQ:ISIZ:AUTO?
Dependencies	Available when Direction is Uplink and PUCCH HARQ-ACK Info Size Auto Detect is Off.
Preset	0 ON
State Saved	Saved in instrument state.
Min	0

Max	2
Initial S/W Revision	A.10.00

PUCCH CQI/PMI

Displays a menu that enables you to set the Channel Quality & Precoding Matrix Indicator information size in bits.

Key Path	Meas Setup, Decode, PUCCH Decode Parameters
Mode	LTE, LTETDD
Initial S/W Revision	A.10.00

PUCCH CQI/PMI Info Size

Specifies the CQI/PMI information size in bits.

When AutoDet is selected, information size will be auto detected as far as possible.

TIP: For the best demodulation performance, specify Info Size manually.

Key Path	Meas Setup, Decode, PUCCH Decode Parameters, CQI/PMI
Mode	LTE, LTETDD
Remote Command	[:SENSe] :EVM:ULINk:DECode:PUCCh:CQI:ISIZe <integer> [:SENSe] :EVM:ULINk:DECode:PUCCh:CQI:ISIZe? [:SENSe] :EVM:ULINk:DECode:PUCCh:CQI:ISIZe:AUTO OFF ON 0 1 [:SENSe] :EVM:ULINk:DECode:PUCCh:CQI:ISIZe:AUTO?
Example	EVM:ULIN:DEC:PUCC:CQI:ISIZ 0 EVM:ULIN:DEC:PUCC:CQI:ISIZ? EVM:ULIN:DEC:PUCC:CQI:ISIZ:AUTO 0 EVM:ULIN:DEC:PUCC:CQI:ISIZ:AUTO?
Dependencies	Available when Direction is Uplink and PUCCH HARQ-ACK Info Size Auto Detect is Off.
Preset	0 ON
State Saved	Saved in instrument state.
Min	0
Max	11
Initial S/W Revision	A.10.00

ACK/NACK Feedback Mode

Specifies whether the current HARQ ACK/NACK feedback mode is ACK/NACK multiplexing or ACK/NACK bundling. See 3GPP TS 36.212, Section 5.2.2.6 and 3GPP TS 36.213, Section 7.3 for more information.

Key Path:	Meas Setup, Decode
Mode:	LTETDD
Remote Command:	[:SENSe] :EVM:ULINk:DECode:ANFMode MULTiplexing BUNDling [:SENSe] :EVM:ULINk:DECode:ANFMode?
Example:	EVM:ULIN:DEC:ANFM MULT EVM:ULIN:DEC:ANFM?
Dependencies:	Available when Direction is Uplink.
Preset:	MULTiplexing
State Saved:	Saved in instrument state.
Range:	BUNDling MULTiplexing
Initial S/W Revision:	A.10.00

Advanced

Displays a menu that enables you to select lesser used demodulation parameters for the current measurement. These settings are for advanced users and do not normally require adjustment for most common measurements.

Key Path	Meas Setup, More
Mode	LTE, LTETDD
Initial S/W Revision	Prior to A.02.00
Modified at S/W Revision	A.03.00

Cyclic Prefix Length (Downlink)

Selects whether to automatically detect the Cyclic Prefix Length or specify the cyclic prefix length for Downlink.

- AUTO – Auto detect the Cyclic Prefix Length
- NORMal – Specify Cyclic Prefix Length as Normal (7.03125% the length of the symbol)
- EXTended – Specify Cyclic Prefix Length as Extended (25% the length of the symbol)

Cyclic Prefix Length specifies the cyclic prefix mode. The current Cyclic Prefix Length mode is displayed in the [“Error Summary” on page 1193](#) trace.

The Cyclic Prefix is added by the transmitter to each OFDM symbol by taking the last 7% (or 25% for extended Cyclic Prefix) of the OFDM symbol and appending it to the front. The addition of the Cyclic

Prefix enables time for all the paths in a multipath environment to arrive at the receiver before the symbol is demodulated.

See “[Symbol Timing Adjust](#)” on page 1154 for information about setting the location of the symbol FFT.

Key Path	Meas Setup, Advanced
Mode	LTE, LTETDD
Remote Command	[:SENSE] :EVM:DLINK:SYNC:CPLength AUTO NORMAl EXTended [:SENSE] :EVM:DLINK:SYNC:CPLength? [:SENSE] :EVM:DLINK:SYNC:CPLength:AUTO OFF ON 0 1 [:SENSE] :EVM:DLINK:SYNC:CPLength:AUTO?
Example	EVM:DLIN:SYNC:CPL NORM EVM:DLIN:SYNC:CPL? EVM:DLIN:SYNC:CPL:AUTO 1 EVM:DLIN:SYNC:CPL:AUTO?
Couplings	Coupled with Cyclic Prefix Length (Uplink).
Preset	AUTO ON
State Saved	Saved in instrument state.
Range	Normal Extended
Initial S/W Revision	Prior to A.02.00
Modified at S/W Revision	A.03.00

Auto

Selects Cyclic Prefix Length automatically.

Key Path	Meas Setup, Advanced, Cyclic Prefix Length
Mode	LTE, LTETDD
Initial S/W Revision	Prior to A.02.00
Modified at S/W Revision	A.03.00

Normal

Selects Normal Cyclic Prefix Length.

Key Path	Meas Setup, Advanced, Cyclic Prefix Length
Mode	LTE, LTETDD
Initial S/W Revision	Prior to A.02.00

LTE Modulation Analysis Measurement
Meas Setup (Measurement Setup)

Modified at S/W Revision	A.03.00
--------------------------	---------

Extended

Selects Extended Cyclic Prefix Length.

Key Path	Meas Setup, Advanced, Cyclic Prefix Length
Mode	LTE, LTETDD
Initial S/W Revision	Prior to A.02.00
Modified at S/W Revision	A.03.00

Cyclic Prefix Length (Uplink)

Selects whether to automatically detect the Cyclic Prefix Length or specify the cyclic prefix length for Uplink.

- AUTO – Auto detect the Cyclic Prefix Length
- NORMal – Specify Cyclic Prefix Length as Normal (7.03125% the length of the symbol)
- EXTended – Specify Cyclic Prefix Length as Extended (25% the length of the symbol)

Cyclic Prefix Length specifies the cyclic prefix mode. The current Cyclic Prefix Length mode is displayed in the Error Summary trace.

The Cyclic Prefix is added by the transmitter to each OFDM symbol by taking the last 7% (or 25% for extended Cyclic Prefix) of the OFDM symbol and appending it to the front. The addition of the Cyclic Prefix enables time for all the paths in a multipath environment to arrive at the receiver before the symbol is demodulated.

See “[Symbol Timing Adjust](#)” on page 1154 for information about setting the location of the symbol FFT.

Key Path	Meas Setup, Advanced
Mode	LTE, LTETDD
Remote Command	[:SENSe] :EVM:ULINk:SYNC:CPLength AUTO NORMal EXTended [:SENSe] :EVM:ULINk:SYNC:CPLength? [:SENSe] :EVM:ULINk:SYNC:CPLength:AUTO OFF ON 0 1 [:SENSe] :EVM:ULINk:SYNC:CPLength:AUTO?
Example	EVM:ULIN:SYNC:CPL AUTO EVM:ULIN:SYNC:CPL? EVM:ULIN:SYNC:CPL:AUTO 1 EVM:ULIN:SYNC:CPL:AUTO?
Dependencies	When Sync Type is set to PRACH, Auto softkey is grayed out.
Couplings	Coupled with Cyclic Prefix Length (Downlink).

Preset	AUTO ON
State Saved	Saved in instrument state.
Range	Normal Extended
Initial S/W Revision	Prior to A.02.00
Modified at S/W Revision	A.03.00

Auto

Selects Cyclic Prefix Length automatically.

Key Path	Meas Setup, Advanced, Cyclic Prefix Length
Mode	LTE, LTETDD
Initial S/W Revision	Prior to A.02.00
Modified at S/W Revision	A.03.00

Normal

Selects Normal Cyclic Prefix Length.

Key Path	Meas Setup, Advanced, Cyclic Prefix Length
Mode	LTE, LTETDD
Initial S/W Revision	Prior to A.02.00
Modified at S/W Revision	A.03.00

Extended

Selects Extended Cyclic Prefix Length.

Key Path	Meas Setup, Advanced, Cyclic Prefix Length
Mode	LTE, LTETDD
Initial S/W Revision	Prior to A.02.00
Modified at S/W Revision	A.03.00

Extended Freq Lock Range

Provides the ability to reduce the frequency lock range. When this parameter is on, the frequency lock range is two and a half times the subcarrier spacing or 37.5 kHz. When this parameter is off, it is reduced to one half the subcarrier spacing, or 7.5kHz, which enables faster processing time.

Key Path	Meas Setup, More, Advanced
----------	-----------------------------------

Mode	LTE, LTETDD
Remote Command	[:SENSe] :EVM:EXTended:FREQuency:LOCK:RANGe OFF ON 0 1 [:SENSe] :EVM:EXTended:FREQuency:LOCK:RANGe?
Example	EVM:EXT:FREQ:LOCK:RANG OFF EVM:EXT:FREQ:LOCK:RANG?
Preset	OFF
State Saved	Saved in instrument state.
Initial S/W Revision	Prior to A.02.00
Modified at S/W Revision	A.03.00

Equalizer Training

Displays a menu that enables you to set whether or not to equalize the signal.

Channel equalization only applies to phase and amplitude. For information about signal-level timing correction, see [“Sync Type” on page 861](#).

NOTE Small-scale deviations (slot-by-slot or symbol-by-symbol) from the equalization channel frequency response are compensated by EVM Minimization.

Downlink:

The channel frequency response is computed over the entire Result Length, and the resulting coefficients are shown in the Eq Chan Freq Resp trace.

- OFF - When Off is selected, no equalization will be applied to the signal.
- RS - When RS is selected, equalization will be performed using the frequency response calculated from the reference signal for the reference antenna path. The channel frequency response for subcarriers between reference signals will be linearly interpolated. For downlink, the standard only specifies using the reference signal for equalization. However, the LTE demodulator can apply a RS+Data equalization for single-channel downlink signals.
- RSD - When RS+Data is selected, equalization will be performed using the frequency response calculated using the reference signal and the data subcarriers. RS+Data equalization is not supported for multi-antenna downlink signals (when number of input channels is greater than 1).

When including data (PDSCH) subcarriers in equalizer calculations:

1. The demodulator equalizes the signal using the reference signal and demodulates the data subcarrier values.
2. Using the demodulated signal, the demodulator calculates a reference LTE signal (shown in IQ Ref)
3. Then the demodulator calculates another equalizer channel frequency response by comparing all the measured PDSCH and RS subcarrier values with the corresponding reference subcarrier values
4. Finally, the channel frequency response including PDSCH is applied to the signal, the signal is

demodulated, and the results of the demodulation are shown on the traces

A moving average can be applied to the RS subcarriers in frequency. For more information, see [“Moving Average Filter” on page 1152](#)

NOTE To see the measured channel frequency response for the current Tx/Rx path, use the Eq Chan Freq Resp trace.

To see the measured channel frequency responses for all Tx/Rx paths, use the MIMO Eq Chan Freq Resp trace.

The **Equalizer Training** setting determines what subcarriers are used when the Tracking method of EVM Minimization is selected. See the [“EVM Minimization” on page 1165](#) for more information.

Uplink:

Channel frequency responses are computed and equalization is applied on a slot-by-slot basis. These per-slot channel frequency responses are shown in the [“Eq Ch Freq Resp Per Slot” on page 1203](#) trace. The [“Eq Ch Frequency Response” on page 1202](#) trace however shows a single set of channel frequency response coefficients computed from the time data in the [“Search Time” on page 1184](#) trace (capture length defined by [“Result Length” on page 879](#)).

- OFF - When Off is selected, the channel frequency response will still be calculated from the DM-RS subcarriers but will not be applied to the signal.
- RS - When RS is selected, the signal will be equalized using the channel frequency response calculated using the DM-RS subcarriers in the signal.
- RSD - When RS+Data is selected, the LTE demodulator calculates the equalizer channel frequency response according to the standard using the DM-RS subcarriers and the DFT-spread (SC-FDMA) subcarriers (PUSCH). The LTE standard specifies that an RS+Data equalization should be performed for uplink signals.

NOTE PRACH equalization is done differently from the other uplink channels' equalization. First, the channel frequency response is calculated for a PRACH transmission by comparing the received preamble sequence to the reference preamble sequence. Then, the channel frequency response is averaged to a single correction value and this correction is applied to all subcarriers in the PRACH preamble. Each PRACH transmission is equalized separately from the other PRACH transmissions.

PRACH equalization is done this way because if each PRACH subcarrier were corrected individually, the equalization will simply remove the error from the PRACH transmission (resulting in near zero EVM) since the channel frequency response will be calculated from the same subcarriers that were being equalized.

Key Path	Meas Setup, More, Advanced
----------	-----------------------------------

LTE Modulation Analysis Measurement
Meas Setup (Measurement Setup)

Mode	LTE, LTETDD
Remote Command	[:SENSe]:EVM:EQUalizer:TRAIning OFF RS RSD [:SENSe]:EVM:EQUalizer:TRAIning?
Example	EVM:EQU:TRA RS EVM:EQU:TRA?
Preset	RS
State Saved	Saved in instrument state.
Range	None RS RS + Data
Initial S/W Revision	Prior to A.02.00
Modified at S/W Revision	A.03.00

Off

Selects no Equalizer Training.

Key Path	Meas Setup, More, Advanced, Equalizer Training
Mode	LTE, LTETDD
Initial S/W Revision	Prior to A.02.00
Modified at S/W Revision	A.03.00

RS

Selects RS Equalizer Training.

Key Path	Meas Setup, More, Advanced, Equalizer Training
Mode	LTE, LTETDD
Initial S/W Revision	Prior to A.02.00
Modified at S/W Revision	A.03.00

RS + Data

Selects RS + Data Equalizer Training.

Key Path	Meas Setup, More, Advanced, Equalizer Training
Mode	LTE, LTETDD
Initial S/W Revision	A.03.00

Moving Average Filter

Sets the value and state of the Moving Avg Filter.

Moving Avg Filter specifies whether or not to perform a moving average (frequency smoothing) on the reference signals during equalization, as well as the number of RS subcarriers to use in each average.

When Equalizer Training is set to **RS**, a value of 5 RS means the value of an RS subcarrier is calculated as the average of the value of that subcarrier and the values of the next two and previous two RS subcarriers in frequency.

When Equalizer Training is set to **RS+Data**, data subcarriers (PDSCH) in between the RS subcarriers are included in the average. For example, a setting of 3 RS means that the value of an RS subcarrier will be taken as the average of the next and previous RS subcarrier in frequency and all data subcarriers that are in between the next and previous RS subcarriers.

For RS subcarrier locations that do not have enough RS subcarriers to one side or the other (those near the edge of the frequency spectrum), the average is taken over available reference signal subcarriers.

Key Path	Meas Setup, Sync/Format Setup
Mode	LTE, LTETDD
Remote Command	[:SENSe]:EVM:EQAlizer:TRaining:MAFilter:LENGth <integer> [:SENSe]:EVM:EQAlizer:TRaining:MAFilter:LENGth? [:SENSe]:EVM:EQAlizer:TRaining:MAFilter OFF ON 0 1 [:SENSe]:EVM:EQAlizer:TRaining:MAFilter?
Example	EVM:EQU:TRA:MAF:LENG 19 EVM:EQU:TRA:MAF:LENG? EVM:EQU:TRA:MAF ON EVM:EQU:TRA:MAF?
Notes	This parameter will always clip to an odd number. Available when Direction is Downlink.
Preset	19 ON
State Saved	Saved in instrument state.
Min	1
Max	399
Initial S/W Revision	Prior to A.02.00
Modified at S/W Revision	A.03.00

MIMO Channel Frequency Normalize

Selects normalized or non-normalized MIMO Ch Frequency Response trace data. Normalized trace data is scaled to show each MIMO channel antenna path frequency response trace centered around 0 db. For normalized traces, all MIMO Channel paths are individually normalized for magnitude, phase, and time

LTE Modulation Analysis Measurement
Meas Setup (Measurement Setup)

offset. For non-normalized trace data, the trace data is not scaled or modified.

Key Path	Meas Setup, Advanced, Equalizer Training
Mode	LTE, LTETDD
Remote Command	[:SENSE]:EVM:EQUalizer:TRaining:MCFNnormalize OFF ON 0 1 [:SENSE]:EVM:EQUalizer:TRaining:MCFNnormalize?
Example	EVM:EQU:TRA:MCFN OFF EVM:EQU:TRA:MCFN?
Dependencies	Available only when Direction is Downlink.
Preset	ON
State Saved	Saved in instrument state.
Range	On Off
Initial S/W Revision	A.06.00

Equalizer Training Mode

Selects the equalization method. This key is available only when Direction is set to Uplink.

- ZFORcing – Use Zero-Forcing equalizer
- LSQuares – Use Least Squares equalizer

Key Path	Meas Setup, Advanced
Mode	LTE, LTETDD
Remote Command	[:SENSE]:EVM:EQUalizer:TRaining:MODE ZFORcing LSQuares [:SENSE]:EVM:EQUalizer:TRaining:MODE?
Example	EVM:EQU:TRA:MODE ZFOR EVM:EQU:TRA:MODE?
Dependencies	Available only when Direction is Uplink. Disabled when Sync Type is PRACH.
Preset	ZFORcing
State Saved	Saved in instrument state.
Range	Zero Forcing Least Squares
Initial S/W Revision	A.06.00

Symbol Timing Adjust

Sets the demodulator to equalize the signal (i.e., whether or not to compensate for measured channel

frequency response).

Key Path	Meas Setup, More, Advanced
Mode	LTE, LTETDD
Remote Command	[:SENSE] :EVM:SYMBOL:TIMing:ADJust MAX MIN START END CENTER FFTSize [:SENSE] :EVM:SYMBOL:TIMing:ADJust?
Example	EVM:SYMB:TIM:ADJ MAX EVM:SYMB:TIM:ADJ?
Preset	MAX
State Saved	Saved in instrument state.
Range	Max of EVM Win Start/End Min of EVM Win Start/End EVM Window Start EVM Window End EVM Window Center %FFT Size
Initial S/W Revision	Prior to A.02.00
Modified at S/W Revision	A.03.00

Max of EVM Window Start/End

Selects Max of EVM Window Start/End for Symbol Timing Adjust . When Max of EVM Window Start / End selected, the EVM for each subcarrier comes from the data set determined in the following manner: For each OFDM symbol, two FFTs are taken to determine the values of the subcarriers. The first FFT is taken starting at the beginning of the EVM Window. The second is taken starting at the end of the EVM Window. Two sets of EVMs are calculated for the subcarriers, one from each FFT. Then an RMS average is taken over each set. The set with the highest RMS average EVM is then chosen as the set to use in EVM and demodulation results.

Key Path	Meas Setup, More, Advanced, Symbol Timing Adjust
Mode	LTE, LTETDD
Initial S/W Revision	Prior to A.02.00
Modified at S/W Revision	A.03.00

Min of EVM in Start/End

Selects Min of EVM Window Start/End for Symbol Timing Adjust. When Min of EVM Window Start / End is selected, the EVM for each subcarrier comes from the data set determined in the following manner: For each OFDM symbol, two FFTs are taken to determine the values of the subcarriers. The first FFT is taken starting at the beginning of the EVM Window. The second is taken starting at the end of the EVM Window. Two sets of EVMs are calculated for the subcarriers, one from each FFT. Then an RMS average is taken over each set. The set with the highest RMS average EVM is then chosen as the set to use in EVM and demodulation results.

Key Path	Meas Setup, More, Advanced, Symbol Timing Adjust
----------	---

LTE Modulation Analysis Measurement
Meas Setup (Measurement Setup)

Mode	LTE, LTETDD
Initial S/W Revision	Prior to A.02.00
Modified at S/W Revision	A.03.00

EVM Window Start

Selects EVM Window Start for Symbol Timing Adjust .

Key Path	Meas Setup, More, Advanced, Symbol Timing Adjust
Mode	LTE, LTETDD
Initial S/W Revision	Prior to A.02.00
Modified at S/W Revision	A.03.00

EVM Window End

Selects EVM Window Stop for Symbol Timing Adjust.

Key Path	Meas Setup, More, Advanced, Symbol Timing Adjust
Mode	LTE, LTETDD
Initial S/W Revision	Prior to A.02.00
Modified at S/W Revision	A.03.00

EVM Window Center

Selects EVM Window Center for Symbol Timing Adjust.

Key Path	Meas Setup, More, Advanced, Symbol Timing Adjust
Mode	LTE, LTETDD
Initial S/W Revision	Prior to A.02.00
Modified at S/W Revision	A.03.00

% FFT Size

Selects %FFT Size for Symbol Timing Adjust which enables you to enter the value. When % of FFT Size is selected, the symbol FFT used for EVM and demodulation results begins at the specified location. A maximum value of 0% begins the FFT at the end of the CP (beginning of the Symbol). The minimum value of -7.125% (or -25% for extended CP Length) begins the FFT at the beginning of the cyclic prefix. Setting the value to 0% will provide the maximum amount of time for all the paths in a multipath environment to arrive at the receiver before the symbol FFT is taken.

Key Path	Meas Setup, More, Advanced, Symbol Timing Adjust
Mode	LTE, LTETDD

Remote Command	[:SENSE]:EVM:SYMBOL:TIMing:ADJust:USER <percent> [:SENSE]:EVM:SYMBOL:TIMing:ADJust:USER?
Example	EVM:SYMB:TIM:ADJ:USER -3.125 EVM:SYMB:TIM:ADJ:USER?
Preset	-3.125 %
State Saved	Saved in instrument state.
Min	-25 %
Max	0 %
Initial S/W Revision	Prior to A.02.00
Modified at S/W Revision	A.03.00

EVM Window Length

Selects the EVM Window Length.

EVM Window Length specifies the length of the window used for EVM calculations. The EVM window is centered in the cyclic prefix.

A value of 3GPP will set EVM Window Length according to the LTE standard for EVM measurements. A Custom EVM window length can also be specified in the range of 1–512 samples. A value of 512 samples corresponds to the entire CP length for Extended CP on a 20 MHz signal.

The standard states that the EVM for an LTE signal's subcarriers should be taken from the higher of the two EVM RMS averages calculated from the FFTs taken from the start and from the end of the EVM window. For example, an EVM Window Length of 3 samples means that two FFTs will be taken, one on either sample adjacent to the center sample of the CP. The EVMs for the subcarriers will come from the FFT with the higher EVM RMS average. However, the location of the symbol FFT used for EVM calculations can be set specifically using the Symbol Timing Adjust parameter.

NOTE	<p>A value of 1 sample will cause the EVM to be measured from an FFT taken from the center of the cyclic prefix, since any other FFTs will just be taken over the same sample points.</p> <p>EVM Window Length does not apply when Symbol Timing Adjust is set to % of FFT Size or EVM Window Center since these settings cause only one FFT to be taken starting from the specified location within the cyclic prefix regardless of the EVM Window Length setting.</p>
-------------	---

Key Path	Meas Setup, More, Advanced
Mode	LTE, LTETDD

LTE Modulation Analysis Measurement
Meas Setup (Measurement Setup)

Remote Command	[:SENSE] :EVM:WINDow:LENGth GPP CUSTom [:SENSE] :EVM:WINDow:LENGth?
Example	EVM:WIND:LENG GPP EVM:WIND:LENG?
Preset	GPP
State Saved	Saved in instrument state.
Range	RS None
Initial S/W Revision	Prior to A.02.00
Modified at S/W Revision	A.03.00

3GPP

Selects 3GPP for EVM Window Length.

Key Path	Meas Setup, More, Advanced, EVM Window Length
Mode	LTE, LTETDD
Initial S/W Revision	Prior to A.02.00
Modified at S/W Revision	A.03.00

Custom

Selects Custom for EVM Window Length, which enables you to enter the value. The value used is EVM Window Length Custom.

Key Path	Meas Setup, More, Advanced, EVM Window Length
Mode	LTE, LTETDD
Initial S/W Revision	Prior to A.02.00
Modified at S/W Revision	A.03.00

EVM Window Length Custom

Sets the EVM Window Length. This key is available only when EVM Window Length is set to Custom

Key Path	Meas Setup, More, Advanced, EVM Window Length, Custom
Mode	LTE, LTETDD
Remote Command	[:SENSE] :EVM:WINDow:LENGth:CUSTom <int> [:SENSE] :EVM:WINDow:LENGth:CUSTom?
Example	EVM:WIND:LENG:CUST 1 EVM:WIND:LENG:CUST?

Preset	32
State Saved	Saved in instrument state.
Min	1
Max	<p>The max value differs depending on the Sync Type (Uplink) and BW the user selected.</p> <p>When Sync Type (Uplink) is set to PRACH;</p> <p>1.4 MHz -> 1314 3 MHz -> 2628 5 MHz -> 5256 10 MHz -> 10512 15 MHz -> 15768 20 MHz -> 21024</p> <p>When Sync Type (Uplink) is set to other than PRACH;</p> <p>1.4 MHz -> 32 3 MHz -> 64 5 MHz -> 128 10 MHz -> 256 15 MHz -> 384 20 MHz -> 512</p>
Initial S/W Revision	Prior to A.02.00
Modified at S/W Revision	A.03.00, A.06.00

Result Format

Displays a menu of keys that enables you to set the result format.

Key Path	Meas Setup, More, Advanced
Mode	LTE, LTETDD
Initial S/W Revision	A.06.00

Report EVM in dB

Switches the unit of EVM reporting between percentage and dB.

When set to ON, EVM is reported in dB on all traces.

When set to Off, EVM is reported in %rms according to the LTE standard.

The reference for EVM calculation in both cases is the ideal IQ points that are displayed on the IQ Ref

LTE Modulation Analysis Measurement
Meas Setup (Measurement Setup)

and IQ Ref Time traces.

Key Path	Meas Setup, Advanced, Result Format
Mode	LTE, LTETDD
Remote Command	[:SENSe] :EVM:REPort:DB OFF ON 0 1 [:SENSe] :EVM:REPort:DB?
Example	EVM:REP:DB OFF EVM:REP:DB?
Preset	OFF
State Saved	Saved in instrument state.
Initial S/W Revision	Prior to A.02.00
Modified at S/W Revision	A.03.00

Report Relative Power Levels

Switches the unit of Power reporting between in Absolute (dBm) and relative (dB).

The following traces are affected by this parameter:

- Error Vector Spectrum
- Error Vector Time
- IQ Freq Meas
- IQ Freq Ref
- IQ Meas
- IQ Meas Time
- IQ Ref
- IQ Ref Time
- RB Error Mag Spectrum
- RB Error Mag Time
- RB Power Spectrum
- RB Power Time
- RMS Error Vector Spectrum
- RMS Error Vector Time

The only summary table affected by this parameter is the Frame Summary table. The channel power will be reported in dB when this parameter is selected and in dBm when this parameter is cleared. The power

values reported on Error Summary and MIMO Info Table are not affected by this parameter.

Key Path	Meas Setup, Advanced, Result Format
Mode	LTE, LTETDD
Remote Command	[:SENSE]:EVM:REPort:POWer:RELative OFF ON 0 1 [:SENSE]:EVM:REPort:POWer:RELative?
Example	EVM:REP:POW:REL OFF EVM:REP:POW:REL?
Preset	ON
State Saved	Saved in instrument state.
Initial S/W Revision	A.03.00

Power Boost Normalize

Determines if Power Boost Normalize is used.

When Power Boost Normalize is enabled, results displayed on IQ traces will be normalized by the power level (set for each channel in the LTE Allocation Editor) or power boost (in Downlink Control Channel Properties) settings of the corresponding channels so that each channel's average power is 0 dB.

Key Path	Meas Setup, Advanced, Result Format
Mode	LTE, LTETDD
Remote Command	[:SENSE]:EVM:POWer:BOOSt:NORMalize OFF ON 0 1 [:SENSE]:EVM:POWer:BOOSt:NORMalize?
Example	EVM:POW:BOOS:NORM OFF EVM:POW:BOOS:NORM?
Preset	ON
State Saved	Saved in instrument state.
Initial S/W Revision	Prior to A.02.00
Modified at S/W Revision	A.03.00

UE-RS Weights

Displays a menu that enables you to set UE-RS Weights parameters.

Key Path	Meas Setup, Advanced, Result Format
Mode	LTETDD
Initial S/W Revision	A.10.00

LTE Modulation Analysis Measurement
Meas Setup (Measurement Setup)

Compensate Chan Freq Resp

Determines whether the UE-RS weights are compensated for the channel calculated from the Reference Signal.

On: the UE-RS weights are compensated for the channel frequency response which is shown in the Eq Chan Freq trace.

Off: the UE-RS weights are not compensated for the channel frequency response.

Key Path	Meas Setup, Advanced, Result Format, UE-RS Weights
Mode	LTETDD
Remote Command	[:SENSE] : EVM : DLINK : UERS : CFRCompen OFF ON 0 1 [:SENSE] : EVM : DLINK : UERS : CFRCompen?
Example	EVM:DLIN:UERS:CFRC ON EVM:DLIN:UERS:CFRC?
Notes	Available when Direction is Downlink.
Preset	ON
State Saved	Saved in instrument state.
Range	On Off
Initial S/W Revision	A.10.00

Display Weights in Real/Imaginary Format

Determines whether the values of complex UE-RS weights are shown as real/imaginary pairs or as magnitude/phase pairs on the UE-Specific RS Weights summary table.

Key Path:	Meas Setup, Advanced, Result Format, UE-RS Weights
Mode:	LTETDD
Remote Command:	[:SENSE] : EVM : DLINK : UERS : WEIGhts : RIFormat OFF ON 0 1 [:SENSE] : EVM : DLINK : UERS : WEIGhts : RIFormat?
Example:	EVM:DLIN:UERS:WEIG:RIF ON EVM:DLIN:UERS:WEIG:RIF?
Notes:	Available when Direction is Downlink.
Preset:	ON
State Saved:	Saved in instrument state.
Range:	On Off
Initial S/W Revision:	A.10.00

Weights Display Mode

Determines how the UE-RS weights are shown in the UE-specific Weights summary table.

- PSUBcarrier - Per Subcarrier: the UE-RS weights are shown for each UE-RS subcarrier. UE-RS subcarrier weights are averaged over all subframes in the Measurement Interval.
- PRB - Per RB: the UE-RS weights are shown for each resource block in frequency. A UE-RS weight for a resource block is averaged over the subcarriers in the resource block as well as all subframes in the Measure Interval.
- PUSer - Per User: UE-RS subcarrier weights are averaged over all UE-RS resource elements in the Measurement Interval for a user allocation and the averaged UE-RS is shown for each user.

Key Path:	Meas Setup, Advanced, Result Format, UE-RS Weights
Mode:	LTETDD
Remote Command:	[:SENSE] :EVM:DLINK:UERS:WEIGHTs:DISPlay PSUBcarrier PRB PUSer [:SENSE] :EVM:DLINK:UERS:WEIGHTs:DISPlay?
Example:	EVM:DLIN:UERS:WEIG:DISP PUSer EVM:DLIN:UERS:WEIG:DISP?
Notes:	Available when Direction is Downlink.
Preset:	PUSer
State Saved:	Saved in instrument state.
Range:	PSUBcarrier PRB PUSer
Initial S/W Revision:	A.10.00

Time Scale Factor

Sets Time Scale Factor.

Time Scale Factor sets the value by which to scale the bandwidth and time lengths of the measured signal. This setting can be used to compensate for mistuned crystals or to enable demodulation of signals at a lower rate, such as half rate or 1/10 rate.

Key Path	Meas Setup, More, Advanced, More
Mode	LTE, LTETDD
Remote Command	[:SENSE] :EVM:TIME:SCALE:FACTor <value> [:SENSE] :EVM:TIME:SCALE:FACTor?
Example	EVM:TIME:SCAL:FACT 1 EVM:TIME:SCAL:FACT?
Preset	1
State Saved	Saved in instrument state.
Min	0.0625
Max	16

LTE Modulation Analysis Measurement
Meas Setup (Measurement Setup)

Initial S/W Revision	Prior to A.02.00
Modified at S/W Revision	A.03.00

Multi Carrier Filter

Specifies whether or not to apply a filter to the received LTE signal to filter out adjacent carriers.

When other carriers are expected to be adjacent to the LTE carrier of interest, this multi-carrier filter can be used to filter out the unwanted carrier and minimize leakage into the LTE carrier of interest.

Key Path	Meas Setup, Advanced
Mode	LTE, LTETDD
Remote Command	[:SENSe]:EVM:MCFilter:STATe OFF ON 0 1 [:SENSe]:EVM:MCFilter:STATe?
Example	EVM:MCF:STAT ON EVM:MCF:STAT?
Preset	OFF
State Saved	Saved in instrument state.
Range	On Off
Initial S/W Revision	A.06.00

Phase Noise Optimization

The Phase Noise Optimization setting affects the phase noise distribution on the analyzer's LO.

Key Path	Meas Setup, Advanced
Mode	LTE, LTETDD
Remote Command	[:SENSe]:EVM:FREQuency:SYNThesis[:STATe] 1 2 [:SENSe]:EVM:FREQuency:SYNThesis[:STATe]?
Example	EVM:FREQ:SYNT 1 EVM:FREQ:SYNT?
Notes	Parameter key: 1 - optimizes phase noise for frequencies offset <20 kHz from the carrier. 2 - optimizes phase noise for frequencies offset >30 kHz from the carrier.
Preset	1
State Saved	Saved in instrument state.
Range	Best Close-in Noise [offset < 20 kHz] Best Wide-offset Noise [offset > 30 kHz]

Initial S/W Revision	A.03.00
----------------------	---------

Best Close-in Noise [offset < 20 kHz]

Selects Best Close-in Noise [offset < 20 kHz] for the Phase Noise Optimization.

Key Path	Meas Setup, Advanced, PhNoise Opt
Mode	LTE, LTETDD
Initial S/W Revision	A.03.00

Best Wide-offset Noise [offset > 30 kHz]

Selects Best Wide-offset Noise [offset > 30 kHz] for the Phase Noise Optimization.

Key Path	Meas Setup, Advanced, PhNoise Opt
Mode	LTE, LTETDD
Initial S/W Revision	A.03.00

EVM Minimization

Selects whether or not EVM Minimization algorithm will be applied. EVM Minimization uses the reference signal to correct the signal.

- OFF - Disable EVM Minimization
- GPP – 3GPP EVM minimization, the demodulator calculates timing, frequency/phase and IQ offset corrections using the reference signal and the data subcarriers as defined in Section F.3.1 of 36.141 for DL and Section E.3.1 of 36.521 for UL. For downlink, the data subcarriers are from PDSCH, and for uplink the data subcarriers are from PUSCH and PUCCH.
 The demodulator applies the corrections on a slot-by-slot basis for uplink, or on a subframe-by-subframe basis for downlink, as defined by the LTE standard.
- TRACKing - Tracking, the demodulator applies corrections on a symbol-by-symbol basis and the Equalizer Training parameter determines whether or not data subcarriers are included in calculating corrections. When Equalizer Training is set to RS+Data, EVM Minimization Tracking is performed using the reference signal and the PDSCH data subcarriers. When Equalizer Training is set to RS or Off, EVM Minimization Tracking is performed using only the reference signal.

Reference signal subcarriers are transmitted periodically in time and frequency. The demodulator compares the reference signals with the expected data sequence and computes an error, or correction value, that can be used to track phase, amplitude, and timing at the symbol level when Tracking is selected and at the slot or subframe level when 3GPP is selected. For subcarriers that do not have a corresponding reference subcarrier to compare to, the correction value is calculated by linearly interpolating between RS (and PDSCH, when Equalizer Training is set to RS+Data) subcarrier corrections.

When corrections are averaged and applied to a slot or subframe, the same correction is applied to each symbol in the slot or subframe.

There are four corrections that can be applied to the signal to minimize the EVM: Amplitude,

LTE Modulation Analysis Measurement
Meas Setup (Measurement Setup)

Frequency/Phase, Timing, and IQ Offset (IQ Offset is only for Uplink). See “EVM Minimization Items” on page 1166 Items for more details.

Key Path	Meas Setup, More, Advanced
Mode	LTE, LTETDD
Remote Command	[:SENSE]:EVM:EVMMinimize OFF GPP TRACKing [:SENSE]:EVM:EVMMinimize?
Example	EVM:EVMM OFF EVM:EVMM?
Dependencies	3GPP is available only when Number of Tx Antenna is set to 1.
Preset	3GPP
State Saved	Saved in instrument state.
Range	Off 3GPP Tracking
Initial S/W Revision	A.03.00

EVM Minimization Items

Four types of corrections are available. They are calculated by comparing the measured reference signal to the ideal reference signal:

- Amplitude - When selected, the average reference signal amplitude error will be used to correct the amplitudes of the subcarriers.
- Frequency/Phase - When selected, the average reference signal phase difference will be used to adjust subcarrier phase.
- Timing - When selected, the average slope (average rate of change) of the RS phase in the frequency domain is used to correct the timing.
- IQ Offset (uplink, 3GPP only) - When selected, any IQ offset is compensated for on a slot-by-slot basis. This type of EVM minimization is only available when 3GPP is selected and the direction is uplink.

For uplink, both equalization and 3GPP EVM Minimization occur on a slot-by-slot basis, while for downlink, equalization occurs over the entire Measurement Interval and 3GPP EVM Minimization occurs on a subframe-by-subframe basis.

Key Path	Meas Setup, More, Advanced
Mode	LTE, LTETDD
Initial S/W Revision	A.03.00

EVM Minimization by Timing

Selects whether or not Timing will be used for EVM minimization algorithm.

Key Path	Meas Setup, More, Advanced, EVM Minimization Items
Mode	LTE, LTETDD
Remote Command	[:SENSe]:EVM:EVMMinimize:TIMing OFF ON 0 1 [:SENSe]:EVM:EVMMinimize:TIMing?
Example	EVM:EVMM:TIM OFF EVM:EVMM:TIM?
Dependencies	Enabled when EVM minimization is set to ON.
Preset	ON
State Saved	Saved in instrument state.
Backwards Compatibility SCPI	[:SENSe]:EVM:PILot:TRACk:TIMing
Initial S/W Revision	A.03.00
Modified at S/W Revision	A.06.00

EVM Minimization by Frequency/Phase

Selects whether or not Frequency/Phase will be used for EVM minimization algorithm.

Key Path	Meas Setup, More, Advanced, EVM Minimization Items
Mode	LTE, LTETDD
Remote Command	[:SENSe]:EVM:EVMMinimize:FREQuency OFF ON 0 1 [:SENSe]:EVM:EVMMinimize:FREQuency?
Example	EVM:EVMM:FREQ OFF EVM:EVMM:FREQ?
Dependencies	Enabled when EVM minimization is set to ON
Preset	ON
State Saved	Saved in instrument state.
Backwards Compatibility SCPI	[:SENSe]:EVM:PILot:TRACk:PHASe
Initial S/W Revision	A.03.00
Modified at S/W Revision	A.06.00

EVM Minimization by Amplitude

Selects whether or not Amplitude will be used for EVM minimization algorithm.

Key Path	Meas Setup, More, Advanced, EVM Minimization Items
Mode	LTE, LTETDD
Remote Command	[:SENSE]:EVM:EVMMinimize:AMPLitude OFF ON 0 1 [:SENSE]:EVM:EVMMinimize:AMPLitude?
Example	EVM:EVMM:AMPL OFF EVM:EVMM:AMPL?
Dependencies	Enabled when EVM minimization is set to ON
Preset	ON
State Saved	Saved in instrument state.
Backwards Compatibility SCPI	[:SENSE]:EVM:PILOt:TRACk:AMPLitude
Initial S/W Revision	A.03.00
Modified at S/W Revision	A.06.00

EVM Minimization by IQ Offset

Selects whether or not IQ Offset will be used for EVM minimization algorithm.

Key Path	Meas Setup, More, Advanced, EVM Minimization Items
Mode	LTE, LTETDD
Remote Command	[:SENSE]:EVM:EVMMinimize:IQOffset OFF ON 0 1 [:SENSE]:EVM:EVMMinimize:IQOffset?
Example	EVM:EVMM:IQOF OFF EVM:EVMM:IQOF?
Dependencies	Enabled when EVM minimization is set to ON and Direction is Uplink.
Preset	ON
State Saved	Saved in instrument state.
Backwards Compatibility SCPI	[:SENSE]:EVM:ULINK:SYNC:IQOComp
Initial S/W Revision	A.03.00

Exclude EVM Transient Time

Excludes the EVM results calculated from part of OFDM symbols during a PUSCH allocation change as specified by the standard.

Key Path	Meas Setup, Advanced
----------	----------------------

Mode	LTE, LTETDD
Remote Command	[:SENSe]:EVM:EETTime OFF ON 0 1 [:SENSe]:EVM:EETTime?
Example	EVM:EETT ON EVM:EETT?
Notes	Available when Direction is Uplink.
Preset	OFF
State Saved	Saved in instrument state.
Range	On Off
Initial S/W Revision	A.10.00

Opposite Direction Active

Specifies whether or not the signal for opposite direction is present in the signal under test. For example, when downlink signal is under test, if there is also uplink signal present in uplink subframe, set the Opposite Direction Active to On will make the measurement more accurate with the knowledge of possible interference from uplink subframes.

Key Path	Meas Setup, Advanced
Mode	LTETDD
Remote Command	[:SENSe]:EVM:ODActive OFF ON 0 1 [:SENSe]:EVM:ODActive?
Example	EVM:ODAC ON EVM:ODAC?
Preset	OFF
State Saved	Saved in instrument state.
Range	On Off
Initial S/W Revision	A.10.00

Antenna Element Spacing

Specifies the distance between the antennas in a linear antenna array. This parameter is used only for calculating the Antenna Beam Pattern trace, which shows the beam patterns applied to PDSCH user allocations.

This parameter is specified in units of wavelengths of the Center Frequency.

NOTE

NOTE The LTE demodulator only supports vertical linear antenna arrays with uniform

spacing.

Key Path	Meas Setup, Advanced
Mode	LTETDD
Remote Command	[:SENSe] :EVM:AESPacing <double> [:SENSe] :EVM:AESPacing?
Example	EVM:AESP 0 EVM:AESP?
Dependencies	Available when Direction is Downlink.
Preset	0.5
State Saved	Saved in instrument state.
Min	0
Max	100
Initial S/W Revision	A.10.00

Meas Preset

Immediately sets all measurement parameters to their Preset values. For more information, see the section under the [“Mode Preset” on page 186](#) in the Utility section..

Key Path	Meas Setup, More
Mode	LTE, LTETDD
Initial S/W Revision	Prior to A.02.00
Modified at S/W Revision	A.03.00

Mode

See [“Mode” on page 1534](#) in the section "Common Measurement Functions" for more information.

Key Path	Front Panel
----------	--------------------

Mode Setup

See “[Mode Setup](#)” on page 1553 in the section "Common Measurement Functions" for more information.

Key Path	Front Panel
----------	--------------------

Peak Search

See [“Peak Search” on page 1706](#) for more information.

Key Path	Front Panel
----------	-------------

Recall

See “[Recall](#)” on page 194 for more information.

Key Path	Front Panel
----------	--------------------

Restart

See [“Restart” on page 1558](#) in the section "Common Measurement Functions" for more information.

Key Path	Front Panel
----------	--------------------

Save

See “[Save](#)” on page 207 in the section "Common Measurement Functions" for more information.

Key Path	Front Panel
----------	--------------------

Single

See “[Single \(Single Measurement/Sweep\)](#)” on page 1563 in the section "Common Measurement Functions" for more information.

Key Path	Front Panel
----------	-------------

Source

This mode does not have any Source functionality. See [“Source” on page 1564](#) in the section "Common Measurement Functions" for a description of this function.

.

Key Path	Front Panel
----------	-------------

SPAN X Scale

See [“SPAN X Scale” on page 1716](#) for details.

Key Path	Front Panel
----------	--------------------

Span

See [“Span” on page 1716](#) for details. Note that in the LTE FDD/TDD mode, this key is available only for Modulation Analysis measurement.

Key Path	SPAN X Scale
----------	---------------------

Full Span

See [“Full Span” on page 1717](#) for details. Note that in the LTE FDD/TDD mode, this key is available only for Modulation Analysis measurement.

Key Path	SPAN X Scale
----------	---------------------

Sweep / Control

See “[Sweep/Control](#)” on page 1724 for a description of this function.

Key Path	Front Panel
----------	-------------

Trace/Detector

Selects the results shown in the trace windows. There are no SCPI features unique to this measurement other than the selections under Data.

Displays a menu that enables you to select Trace/Detector parameters for Uplink signals.

See “Trace/Detector” on page 1728 for more information.

Key Path	Front Panel
Mode	LTE, LTETDD
Initial S/W Revision	Prior to A.02.00
Modified at S/W Revision	A.03.00

Data

Displays a menu of Trace data choices for the selected trace.

The following table shows available trace data types. The SCPI command “:DISPlay:EVM:TRACe[1]|2|3|4:FEED <string>” can be used to configure the trace data. For example, the following command sets the first trace to Spectrum.

:DISP:EVM:TRAC1:FEED “Spectrum1”

Soft Key Name	SCPI string form	
Pre Demod		
Spectrum	"Spectrum1"	
Inst Spectrum	"Inst Spectrum1"	
Search Time	"Search Time1"	
Time	"Time1"	
Raw Main Time	"Raw Main Time1"	
Demod	<Uplink>	<Downlink>
IQ Meas	"Demod IQ Meas1"	"Layer IQ Meas1"
IQ Ref	"Demod IQ Ref1"	"Layer IQ Ref1"
IQ Meas Time	"Demod IQ Meas Time1"	"Layer IQ Meas Time1"
IQ Ref Time	"Demod IQ Ref Time1"	"Layer IQ Ref Time1"
IQ Freq Meas	"Demod IQ Freq Meas1"	"Layer IQ Freq Meas1"
IQ Freq Ref	"Demod IQ Freq Ref1"	"Layer IQ Freq Ref1"

LTE Modulation Analysis Measurement
Trace/Detector

Detected Allocations	"Demod Detected Allocations Time1"	"Layer Detected Allocations Time1"
Antenna Beam Pattern	N/A	"Demod Antenna Beam Pattern 1"
Demod Error	<Uplink>	<Downlink>
Error Vector Time	"Demod Error Vector Time1"	"Layer Error Vector Time1"
RMS Error Vector Time	"Demod RMS Error Vector Time1"	"Layer RMS Error Vector Time1"
Error Vector Spectrum	"Demod Error Vector Spectrum1"	"Layer Error Vector Spectrum1"
RMS Error Vector Spectrum	"Demod RMS Error Vector Spectrum1"	"Layer RMS Error Vector Spectrum"
Common Tracking Error	"Demod Common Tracking Error1"	
RB Error Mag Spectrum	"Demod RB Error Mag Spectrum1"	"Layer RB Error Mag Spectrum1"
RB Error Mag Time	"Demod RB Error Mag Time1"	"Layer RB Error Mag Time1"
RB Power Spectrum	"Demod RB Power Spectrum1"	"Layer RB Power Spectrum1"
RB Power Time	"Demod RB Power Time1"	"Layer RB Power Time1"
Freq Err Per Slot	"Demod Freq Err Per Slot1"	
IQ Offset Per Slot	"Demod IQ Offset Per Slot1"	
In-band Emissions.	"Demod In-band Emissions1"	
Tables		
Error Summary	"Demod Error Summary1"	
Frame Summary	"Demod Frame Summary1"	
Symbols (Uplink)	"Demod Symbol Table1"	
Symbols (Downlink)	"Layer Symbol Table1"	
Decoded Symbol Table (Uplink)	"Demod Decoded Symbol Table1"	
Decoded Symbol Table (Downlink)	"Demod CW0 Decoded Symbol Table1"	
DL Decode Info	"Demod DL Decode Info1"	
UL Decode Info	"Demod UL Decode Info1"	
UE-RS Weights	"Demod UE-specific RS Weights1"	
Response		
Eq Ch Freq Resp	"Demod Eq Chan Freq Resp1"	

Inst Eq Ch Freq Resp	"Demod Inst Eq Chan Freq Resp1"
Eq Ch Freq Resp Diff	"Demod Eq Chan Freq Resp Diff1"
Inst Eq Ch Freq Resp Diff	"Demod Inst Eq Chan Freq Resp Diff1"
Eq Impulse Response	"Demod Eq Impulse Response1"
Eq Ch Freq Resp Per Slot	"Demod Per Slot Eq Chan Freq Resp1"
MIMO	
Info Table	"MIMO Info Table1"
Ch Freq Resp	"MIMO Eq Chan Freq Resp1"
Ch Freq Resp Diff	"MIMO Eq Chan Freq Resp Diff1"
Eq Impulse Resp	"MIMO Eq Impulse Response1"
Common Track Error	"MIMO Common Tracking Error1"

For further details, see [“Data” on page 1730](#) and [“Remote SCPI Commands and Data Queries” on page 1789](#) in the section [“Common Measurement Functions 2.”](#)

Key Path	Trace/Detector
Mode	LTE, LTETDD
Initial S/W Revision	Prior to A.02.00
Modified at S/W Revision	A.03.00

Pre Demod

Displays the Trace Data choices that show pre-demodulation results. See [“Data” on page 1181](#) for the corresponding SCPI command.

Key Path	Trace/Detector, Data
Mode	LTE, LTETDD
Initial S/W Revision	Prior to A.02.00
Modified at S/W Revision	A.03.00

Spectrum

Averaged FFT of the Time waveform. See [“Data” on page 1181](#) for the corresponding SCPI command.

Key Path	Trace/Detector, Data, Pre Demod
Mode	LTE, LTETDD
Initial S/W Revision	Prior to A.02.00

Modified at S/W Revision	A.03.00
--------------------------	---------

Inst Spectrum

FFT of the time waveform for the current measurement. “Inst” or Instantaneous refers to this result not being averaged like the Trace Data result. See [“Data” on page 1181](#) for the corresponding SCPI command.

Key Path	Trace/Detector, Data, Pre Demod
Mode	LTE, LTETDD
Initial S/W Revision	Prior to A.02.00
Modified at S/W Revision	A.03.00

Search Time

Search Length long time record acquired for the current measurement. See [“Data” on page 1181](#) for the corresponding SCPI command.

Key Path	Trace/Detector, Data, Pre Demod
Mode	LTE, LTETDD
Initial S/W Revision	Prior to A.02.00
Modified at S/W Revision	A.03.00

Time

Time data corresponding to the measurement interval used to compute demod results. See [“Data” on page 1181](#) for the corresponding SCPI command.

Key Path	Trace/Detector, Data, Pre Demod
Mode	LTE, LTETDD
Initial S/W Revision	Prior to A.02.00
Modified at S/W Revision	A.03.00

Raw Main Time

Raw time record acquired for the current measurement. This data is unprocessed and includes additional points acquired for settling of the filters involved in subsequent processing, such as the demodulation filtering. See [“Data” on page 1181](#) for the corresponding SCPI command.

Key Path	Trace/Detector, Data, Pre Demod
Mode	LTE, LTETDD
Initial S/W Revision	Prior to A.02.00
Modified at S/W Revision	A.03.00

Statistical

Displays the Trace Data choices that show statistical results.

Key Path	Trace/Detector, Data
Mode	LTE, LTETDD
Initial S/W Revision	Prior to A.02.00
Modified at S/W Revision	A.03.00

CCDF

The Complementary, Cumulative Density function (CCDF) for the selected input channel.

The analyzer plots CCDF using units of percent (%) for the y-axis and power (dB) for the x-axis. Power on the x-axis is relative to the signal average power.

Key Path	Trace/Detector, Data, Statistical
Mode	LTE, LTETDD
Initial S/W Revision	Prior to A.02.00
Modified at S/W Revision	A.03.00

CDF

The Cumulative Density Function (CDF) for the selected input channel. CDF is computed by integrating the PDF (Probability Density Function).

Key Path	Trace/Detector, Data, Statistical
Mode	LTE, LTETDD
Initial S/W Revision	Prior to A.02.00
Modified at S/W Revision	A.03.00

PDF

The Probability Density Function (PDF) for the selected input channel. PDF indicates the probability that a given level has occurred.

Key Path	Trace/Detector, Data, Statistical
Mode	LTE, LTETDD
Initial S/W Revision	Prior to A.02.00
Modified at S/W Revision	A.03.00

Demod

Displays the Trace Data choices which show general demodulation results.

Key Path	Trace/Detector, Data
Mode	LTE, LTETDD
Initial S/W Revision	Prior to A.02.00
Modified at S/W Revision	A.03.00

IQ Meas

IQ Meas is the measured IQ symbol values of the subcarriers. There is one complex value for each subcarrier for each symbol in the burst.

Normally this trace data is displayed as a constellation. The constellation display shows both data and pilot subcarriers, the pilots and data values are shown in different colors.

See [“Data” on page 1181](#) for the corresponding SCPI command.

Key Path	Trace/Detector, Data, Demod
Mode	LTE, LTETDD
Initial S/W Revision	Prior to A.02.00
Modified at S/W Revision	A.03.00

IQ Ref

IQ Ref is the reference (ideal) IQ values of the subcarriers. There is one complex value for each subcarrier for each symbol in the burst.

Normally this trace data is displayed as a constellation. The constellation shows both data and pilot subcarrier symbols, the pilots and data values are shown in different colors.

See [“Data” on page 1181](#) for the corresponding SCPI command.

Key Path	Trace/Detector, Data, Demod
Mode	LTE, LTETDD
Initial S/W Revision	Prior to A.02.00
Modified at S/W Revision	A.03.00

IQ Meas Time

IQ Meas and IQ Ref traces show signal levels as a function of subcarriers or samples/subcarriers. Signals levels on different OFDM symbols are shown as different points on the same vertical line corresponding to a subcarrier or subcarrier/sample. There is also value in showing these traces as a function of symbols on the X-axis. For each symbol, different subcarriers or samples will be shown as different points on the same vertical line.

See “Data” on page 1181 for the corresponding SCPI command.

Key Path	Trace/Detector, Data, Demod
Mode	LTE, LTETDD
Initial S/W Revision	Prior to A.02.00
Modified at S/W Revision	A.03.00

IQ Ref Time

IQ Ref Time is similar to IQ Meas Time, except that the points plotted are the expected signal levels instead of the measured ones. See “Data” on page 1181 for the corresponding SCPI command.

Key Path	Trace/Detector, Data, Demod
Mode	LTE, LTETDD
Initial S/W Revision	Prior to A.02.00
Modified at S/W Revision	A.03.00

IQ Freq Meas

IQ Freq Meas displays the measured IQ values (measured at the output of the FFT) of the subcarriers for each OFDM symbol point. This trace is identical to IQ Meas in downlink mode since IQ Meas also displays measured IQ values at the output of FFT. In uplink mode, while IQ Meas displays PUSCH values after despreading (IFFT), IQ Freq Meas continues to display PUSCH IQ values at the output of the FFT, which resembles a collection of random points concentrated around the origin. See “Data” on page 1181 for the corresponding SCPI command.

NOTE To view SC-FDMA (uplink PUSCH) signals in the time domain, use IQ Meas.

The data in IQ Freq Meas, which comes from the Time trace data as that data is passed through the demodulator, is a 2x2 matrix with frequency along one dimension and time along the other. In addition, each one of the points in the matrix is a complex value; therefore there are 4 total dimensions. The choice of trace format determines which two dimensions will be on the x-y plane, and which dimensions will be overlapped, averaged, or ignored. The relevant trace formats and their corresponding view of the data are described below.

Constellation, IQ - The I-Q plane is mapped to the x-y plane and each point contains both a subcarrier and a symbol-time reference. In other words, each point plotted on the complex plane came from a symbol transmitted on a specific subcarrier at a certain time.

LogMag, LinMag, Real, Imag, Wrapped Phase, Unwrapped Phase - Subcarriers are plotted along the x-axis. All the symbols that a subcarrier transmits have been plotted above the corresponding subcarrier tick on the x-axis, in the specified format (whether it be dB magnitude or the real value of the symbol point, etc.).

Key Path	Trace/Detector, Data, Demod
----------	------------------------------------

Mode	LTE, LTETDD
Initial S/W Revision	A.02.00
Modified at S/W Revision	A.03.00

IQ Freq Ref

IQ Freq Ref displays the reference (demodulated) IQ values of the subcarriers for each OFDM symbol point at the output of the FFT. This trace is identical to IQ Ref in downlink mode. In uplink mode, this trace always displays OFDM reference IQ points (unlike IQ Ref, which displays reference PUSCH SC-FDMA IQ points after despreading (IFFT)). See [“Data” on page 1181](#) for the corresponding SCPI command.

NOTE To view SC-FDMA (uplink PUSCH) signals in the time domain, use IQ Meas.

Key Path	Trace/Detector, Data, Demod
Mode	LTE, LTETDD
Initial S/W Revision	A.02.00
Modified at S/W Revision	A.03.00

Detected Allocations

Detected Allocations displays the RB allocations detected by the measurement if “Auto Detect” is on, or the user-configured RB allocations if “Auto Detect” is off.

See [“Data” on page 1181](#) for the corresponding SCPI command.

Key Path	Trace/Detector, Data, Demod
Mode	LTE, LTETDD
Initial S/W Revision	A.02.00
Modified at S/W Revision	A.03.00

Antenna Beam Pattern

Antenna Beam Pattern shows the antenna beam patterns formed by the UE-RS weights for each PDSCH user allocation that uses UE-RS beamforming.

The UE-RS weights for a PDSCH user allocation are computed by calculating the UE-RS weight values for all UE-RS resource elements in the Measurement Interval for the user allocation and then averaging over all resource elements for each receive antenna. The UE-RS weights used to calculate the antenna beam pattern can be seen in the UE-specific RS Weights summary table when Weights Display Mode is set to Per User.

NOTE The LTE demodulator assumes a vertical, linear antenna array with uniform antenna spacing. The spacing is specified by Antenna Element Spacing.

The antenna beam patterns are color-coded to match the color for the corresponding PDSCH user allocation in the Frame Summary.

NOTE UE-RS weights are assumed to be constant over all subframes in the frame.

Only half of the beam pattern is shown, the other half is symmetric about the origin.

The points on this trace are evenly spaced every 0.5 degree.

The magnitudes of the points for a PDSCH antenna beam pattern are normalized to the peak of the beam pattern.

See Data section for the corresponding SCPI command.

Key Path	Trace/Detector, Data, Demod
Mode	LTE, LTETDD
Initial S/W Revision	A.10.00

Demod Err (Error)

Displays the Trace Data Demod Error choices that show general demodulation results.

Key Path	Trace/Detector, Data
Mode	LTE, LTETDD
Initial S/W Revision	Prior to A.02.00
Modified at S/W Revision	A.03.00

Error Vector Time

This trace shows each of the individual signal error vectors for each subcarrier and symbol vs. Time (symbol) and frequency (subcarrier). Each error vector is the vector difference, for that subcarrier at that symbol-time, between the corresponding IQ Meas value and the IQ Ref value.

On this trace, the individual error vectors are plotted vs Time (symbol). So at each valid symbol, there is a point plotted for each valid subcarrier (52 total, since subcarrier 0 is not used.) In addition, a white trace is drawn, where each point is the RMS average over the valid subcarriers, which is the same result as is plotted separately as RMS Error Vector Time.

See [“Data” on page 1181](#) for the corresponding SCPI command.

Key Path	Trace/Detector, Data, Demod Error
Mode	LTE, LTETDD

Initial S/W Revision	Prior to A.02.00
Modified at S/W Revision	A.03.00

RMS Error Vector Time

The difference between IQ Meas and IQ Ref is the error vector (which will have a complex value) at each subcarrier at each symbol-time. This trace is the RMS average of the error vector for each valid subcarrier at the plotted symbol, the same data shown as a white trace shown in Error Vector Time.

See “Data” on page 1181 for the corresponding SCPI command.

Key Path	Trace/Detector, Data, Demod Error
Mode	LTE, LTETDD
Initial S/W Revision	Prior to A.02.00
Modified at S/W Revision	A.03.00

Error Vector Spectrum

This trace, like Error Vector Time shows each of the individual signal error vectors for each subcarrier and symbol vs. Time (symbol) and frequency (subcarrier). Each error vector is the vector difference, for that subcarrier at that symbol-time, between the corresponding IQ Meas value and the IQ Ref value.

On this trace, the individual error vectors are plotted vs frequency (subcarrier). So at each valid subcarrier, there is a point plotted for each valid symbol. Note that subcarrier 0 is not plotted since it is not used. In addition, a white trace is drawn, where each point is the RMS average over the valid symbols, which is the same result as is plotted separately as RMS Error Vector Spectrum.

See “Data” on page 1181 for the corresponding SCPI command.

Key Path	Trace/Detector, Data, Demod Error
Mode	LTE, LTETDD
Initial S/W Revision	Prior to A.02.00
Modified at S/W Revision	A.03.00

RMS Error Vector Spectrum

This trace is the RMS average of the error vector for each valid symbol at the plotted subcarrier, the same data shown as a white trace shown in Error Vector Time. Note that subcarrier 0 is not plotted since it is not used.

See “Data” on page 1181 for the corresponding SCPI command.

Key Path	Trace/Detector, Data, Demod Error
Mode	LTE, LTETDD
Initial S/W Revision	Prior to A.02.00

Modified at S/W Revision	A.03.00
--------------------------	---------

Common Tracking Error

This trace shows the small scale deviations from the averaged channel response occurring from one symbol to another.

See [“Data” on page 1181](#) for the corresponding SCPI command.

Key Path	Trace/Detector, Data, Demod Error
Mode	LTE, LTETDD
Initial S/W Revision	Prior to A.02.00
Modified at S/W Revision	A.03.00

RB Error Mag Spectrum

This trace shows EVM (calculated as RMS average over one RB and one slot) and as functions of RBs on the X-axis and multiple slots for each RB. This is a frequency-domain trace coupled only to other frequency-domain traces (and not mixed-domain traces).

See [“Data” on page 1181](#) for the corresponding SCPI command.

Key Path	Trace/Detector, Data, Demod Error
Mode	LTE, LTETDD
Initial S/W Revision	Prior to A.02.00
Modified at S/W Revision	A.03.00

RB Error Mag Time

This trace shows EVM (calculated as RMS average over one RB and one slot) and as functions of RBs on the X-axis and multiple slots for each RB. This is a frequency-domain trace coupled only to other frequency-domain traces (and not mixed-domain traces).

See [“Data” on page 1181](#) for the corresponding SCPI command.

Key Path	Trace/Detector, Data, Demod Error, More
Mode	LTE, LTETDD
Initial S/W Revision	Prior to A.02.00
Modified at S/W Revision	A.03.00

RB Power Spectrum

This trace shows power levels (calculated as RMS average over one RB and one slot) as functions of RBs on the X-axis and multiple slots for each RB. This is a frequency-domain trace coupled only to other frequency-domain traces (and not mixed-domain traces).

See “Data” on page 1181 for the corresponding SCPI command.

Key Path	Trace/Detector, Data, Demod Error, More
Mode	LTE, LTETDD
Initial S/W Revision	Prior to A.02.00
Modified at S/W Revision	A.03.00

RB Power vs Time

This trace shows power levels (calculated as RMS average over one RB and one slot) as functions of slots on the X-axis and multiple RBs for each slot. This is a frequency-domain trace coupled only to other frequency-domain traces (and not mixed-domain traces).

See “Data” on page 1181 for the corresponding SCPI command.

Key Path	Trace/Detector, Data, Demod Error, More
Mode	LTE, LTETDD
Initial S/W Revision	Prior to A.02.00
Modified at S/W Revision	A.03.00

Freq Err Per Slot

This trace displays the average frequency error for each slot. The frequency error is expressed as an offset in Hz from the current center frequency setting.

See “Data” on page 1181 for the corresponding SCPI command.

Key Path	Trace/Detector, Data, Demod Error, More
Mode	LTE, LTETDD
Initial S/W Revision	A.03.00

IQ Offset Per Slot

IQ Offset Per Slot displays the average IQ Offset for each slot in the Measurement Interval. This trace is only available for uplink signals.

See “Data” on page 1181 for the corresponding SCPI command.

Key Path	Trace/Detector, Data, Demod Error, More
Mode	LTE, LTETDD
Initial S/W Revision	A.03.00

In-band Emissions

Shows the resource block power spectrum for the data specified by Measurement Interval and Measurement Offset.

This trace is identical to RB Power Spectrum except for two differences. The first difference is that In-band Emissions always includes Non-alloc signals, regardless of the Non-Alloc parameter selection. The second difference is that the RB Power levels are normalized such that the average active RB power is 0 dB.

See “Data” on page 1181 for the corresponding SCPI command.

See Section 6.5.2.3 of 3GPP TS 36.521–1 for more information about in-band emissions measurements.

This trace is available only when Direction is Uplink.

Key Path	Trace/Detector, Data, Demod Error,
Mode	LTE, LTETDD
Initial S/W Revision	A.06.00

Tables

Displays the Trace Data choices that are in tabular form, including demodulated symbols tables.

Key Path	Trace/Detector, Data
Mode	LTE, LTETDD
Initial S/W Revision	Prior to A.02.00
Modified at S/W Revision	A.03.00

Error Summary

The Error Summary table shows some metrics calculated from signal demod. The metrics are subject to averaging, unless indicated otherwise. See “Data” on page 1181 for the corresponding SCPI command.

A scrollbar will appear when the contents are too long to be displayed in the window. You can scroll the window without a mouse with the following steps.

1. Press **Next Window** key to select the window you want to scroll.
2. Press **Esc** key to turn off the active function
3. Then, press one of **Arrow** keys.

The following metrics are shown:

- EVM
- EVM Symbol TimeAdjust
- Peak EVM
- Peak EVM location symbol number
- Peak EVM subcarrier number
- Data EVM
- 3GPP-defined QPSK EVM (%rms)

LTE Modulation Analysis Measurement
Trace/Detector

- 3GPP-defined 16QAM EVM (%rms)
- 3GPP-defined 64QAM EVM (%rms)
- RS EVM
- RS Tx. Power (avg)
- OFDM Sym. Tx. Power
- Reference Signal Rx Power (Avg). Downlink only.
- Reference Signal Rx Quality. Downlink only.
- Freq Err
- Sync Corr
- Sync Type
- Common Tracking Error
- Sym Clk Err
- Time Offset (not averaged)
- IQ Offset
- IQ Gain Imb
- IQ Quad Err
- IQ Time Skew
- CP Length (not averaged)
- RS-OS/PRS (not averaged) (downlink only)
- Cell ID (not averaged) (downlink only)
- Cell ID Group/Sector (not averaged) (downlink only)

Result name	Displayed Unit	Remote Name	Remote Unit
EVM	%rms*	EVM	%rms
EVM Symbol Timing Adjust	none	EVMSymTimeAdj	none
EVM Pk	%	EVMPeak	%
Peak EVM location symbol number	sym	EVMPeakIdx	sym
Peak EVM subcarrier number	subcar	EVMPeakSubcarIdx	subcar
3GPP-defined QPSK EVM	%rms*	3GPPEVMQPSK	%rms
3GPP-defined 16QAM EVM	%rms*	3GPPEVM16QAM	%rms

Result name	Displayed Unit	Remote Name	Remote Unit
3GPP-defined 64QAM EVM	%rms*	3GPPEVM64QAM	%rms
Data EVM	%rms*	DataEVM	%rms
RS EVM	%rms*	RSEVM	%rms
RS Tx. Power (avg)	dBm/subcar	RSTP	dBm
OFDM Sym. Tx. Power	dBm	OSTP	dBm
Frequency Error	Hz	FreqErr	Hz
Sync Corr	%	SyncCorr	%
Sync Type	None	SyncType	none
Common Tracking Error	%rms	CTE	%rms
Symbol Clock Err	ppm	SymClkErr	ppm
Time Offset	s	TimeOffset	sec
IQ Offset	dB	IQOffset	dB
IQ Gain Imbalance	dB	IQGainImb	dB
IQ Quadrature Error	deg	IQQuadErr	deg
IQ Timing Skew	s	IQTimingSkew	sec
CP Length Mode	None	CpLengthMode	None
RS-OS / RS	None	RSPRS	None
Cell ID	None	CellId	None
Cell ID Group/Sector	None	CellIdGroupSector	None
Reference Signal Rx Power (Avg)	dBm	RSRP	dBm
Reference Signal Rx Quality	dB	RSRQ	dB

* displayed in dB when Report EVM in dB parameter is On

The error summary values can be obtained using the CALC:EVM:DATA:TABL commands.

See also “:CALCulate:DATA” on page 1793 for more details.

Key Path	Trace/Detector, Data, Tables
Mode	LTE, LTETDD
Initial S/W Revision	Prior to A.02.00
Modified at S/W Revision	A.03.00, A.06.00

Frame Summary

This table shows certain characteristics of each of the logical channels. The list of channels shown is different for Downlink and Uplink. If auto-detection is selected, the list contains only PDSCH1–3, corresponding to the three modulation formats. If a channel is not found in the measurement interval under consideration, it is marked with a ‘...’. Each of the channels shown have the same color coding as used in the IQ demod traces.

See “Data” on page 1181 for the corresponding SCPI command.

A scrollbar will appear when the contents are too long to be displayed in the window. You can scroll the window without a mouse with the following steps.

1. Press **Next Window** key to select the window you want to scroll.
2. Press **Esc** key to turn off the active function
3. Then, press one of **Arrow** keys.

The following are the characteristics that are shown in the Frame Summary Table:

- Channel Name
- Error Vector Magnitude
- Relative Power Level
- Modulation Format
- Number of RBs occupied

When the link direction is downlink, the following channels are shown in the Frame Summary:

- P-SS
- S-SS
- PBCH
- PCFICH
- PHICH
- PDCCH
- RS
- PDSCH1 to PDSCHn
- Non-Alloc

Result name	Displayed Unit	Remote Name	Remote Unit
PSS EVM	%rms	PSSEVM	%rms
PSS Power	dB	PSSPower	dB
PSS Mod Format	none	PSSModFmt	none
PSS Num Rb	none	PSSNumRb	none

Result name	Displayed Unit	Remote Name	Remote Unit
SSS EVM	%rms	SSSEVM	%rms
SSS Power	dB	SSSPower	dB
SSS Mod Format	none	SSSModFmt	none
SSS Num Rb	none	SSSNumRb	none
PBCH EVM	%rms	PBCHEVM	%rms
PBCH Power	dB	PBCHPower	dB
PBCH Mod Format	none	PBCHModFmt	none
PBCH Num Rb	none	PBCHNumRb	none
PCFICH EVM	%rms	PCFICHEVM	%rms
PCFICH Power	dB	PCFICHPower	dB
PCFICH Mod Format	none	PCFICHModFmt	none
PCFICH Num Rb	none	PCFICHNumRb	none
PHICH EVM	%rms	PHICHEVM	%rms
PHICH Power	dB	PHICHPower	dB
PHICH Mod Format	none	PHICHModFmt	none
PHICH Num Rb	none	PHICHNumRb	none
PDCCH EVM	%rms	PDCCHEVM	%rms
PDCCH Power	dB	PDCCHPower	dB
PDCCH Mod Format	none	PDCCHModFmt	none
PDCCH Num Rb	none	PDCCHNumRb	none
RS EVM	%rms	RSEVM	%rms
RS Power	dB	RSPower	dB
RS Mod Format	none	RSMModFmt	none
RS Num Rb	none	RSNumRb	none
PDSCHn EVM	%rms	PDSCHnEVM	%rms
PDSCHn Power	dB	PDSCHnPower	dB
PDSCHn Mod Format	none	PDSCHnModFmt	none
PDSCHn Num Rb	none	PDSCHnNumRb	none
Inactive EVM	%rms	InactiveEVM	%rms
Inactive Power	dB	InactivePower	dB

Result name	Displayed Unit	Remote Name	Remote Unit
Inactive Mod Format	none	InactiveModFmt	none
Inactive Num Rb	none	InactiveNumRb	none

When the link direction is uplink, the following are the channels that are shown in the Frame Summary:

- PUSCH DM-RS
- PUCCH
- PUSCH1 to PUSCHn
- PRACH
- S-RS
- Non-Alloc

Result name	Displayed Unit	Remote Name	Remote Unit
DMRS EVM	%rms	DMRSEVM	%rms
DMRS Power	dB	DMRSPower	dB
DMRS Mod Format	none	DMRSModFmt	none
DMRS Num Rb	none	DMRSNumRb	none
PUCCH EVM	%rms	PUCCH EVM	%rms
PUCCH Power	dB	PUCCH Power	dB
PUCCH Mod Format	none	PUCCH ModFmt	none
PUCCH Num Rb	none	PUCCH NumRb	none
PUSCHn EVM	%rms	PUSCHn EVM	%rms
PUSCHn Power	dB	PUSCHn Power	dB
PUSCHn Mod Format	none	PUSCHn ModFmt	none
PUSCHn Num Rb	none	PUSCHn NumRb	none
PRACH EVM	%rms	PRACHEVM	%rms
PRACH Power	dB	PRACHPower	dB
PRACH Mod Format	none	PRACHModFmt	none
PRACH Num Rb	none	PRACHNumRb	none
SRS EVM	%rms	SRSEVM	%rms
SRS Power	dB	SRSPower	dB
SRS Mod Format	none	SRSModFmt	none

Result name	Displayed Unit	Remote Name	Remote Unit
SRS Num Rb	none	SRSNumRb	none
Inactive EVM	%rms	InactiveEVM	%rms
Inactive Power	dB	InactivePower	dB
Inactive Mod Format	none	InactiveModFmt	none
Inactive Num Rb	none	InactiveNumRb	none

These values are never averaged; they always show the results of the current measurement. These results are valid only for the current measurement interval.

Non-Alloc signals consist of unused subcarriers in all shared and control channels. This includes unallocated user data subcarriers, the DC subcarrier, certain RS subcarriers in multi-antenna mode, and unused P-SS and S-SS subcarriers.

Non-Alloc signals include the following:

- Unallocated user data subcarriers
- The unused DC subcarrier
- Unused P-SS and S-SS subcarriers: these signals are 6 RBs (72 subcarriers) wide in the frequency domain, but only the center 62 subcarriers are actually used, and the remaining 10 are set to zero.
- Subcarriers reserved for RS in a multiple antenna port signal. For example, in a four Tx Antenna signal, the transmission from antenna port 0 will not transmit anything on the subcarriers that will be used for RS in the other three antenna port transmissions.

Manually defined and autodetected user allocations are always considered allocated whether or not they are enabled for display in Composite Include and are not included in Non-Alloc.

Non-alloc means only unallocated shared channel subcarriers (those that could be allocated for users but are not). The rest of the traces consider Non-alloc to be any unused subcarrier (whether in control or shared channels).

Any resource elements (subcarriers) contained by a user channel that is present in the Composite Include list are considered allocated, regardless of whether or not the user channel has been selected for analysis and display.

Non-Alloc signal's EVMs are normalized with respect to the signal's average power per subcarrier, since dividing by the reference vector's magnitude (0 in this case) will cause the result to be undefined.

Key Path	Trace/Detector, Data, Tables
Mode	LTE, LTETDD
Initial S/W Revision	Prior to A.02.00
Modified at S/W Revision	A.03.00

Symbols

This table shows the demodulated symbols over the measurement interval. It displays one value per

subcarrier for downlink and one value per sample/subcarrier for uplink. In uplink, this is a mixed-domain trace and coupled only to other mixed-domain traces (and not frequency domain traces).

See “Data” on page 1181 for the corresponding SCPI command.

A scrollbar will appear when the contents are too long to be displayed in the window. You can scroll the window without a mouse with the following steps.

1. Press **Next Window** key to select the window you want to scroll.
2. Press **Esc** key to turn off the active function
3. Then, press one of **Arrow** keys.

Key Path	Trace/Detector, Data, Tables
Mode	LTE, LTETDD
Initial S/W Revision	Prior to A.02.00
Modified at S/W Revision	A.03.00

Decoded Symbol Table

When Direction is Downlink, this table shows the decoded values of the physical layer channels: PBCH, PDCCH, PCFICH, and PDSCH. The level of decoding is determined by each channel decoding selection (See “Decode Type ” on page 1125 for details.)

When Direction is Uplink, this table shows descrambled PUSCH data when PUSCH Decoding is set to Descrambled. The default bit order for this trace is MSB-first.

See “Data” on page 1181 for the corresponding SCPI command.

A scrollbar will appear when the contents are too long to be displayed in the window. You can scroll the window without a mouse with the following steps.

1. Press **Next Window** key to select the window you want to scroll.
2. Press **Esc** key to turn off the active function
3. Then, press one of **Arrow** keys.

Key Path	Trace/Detector, Data, Tables
Mode	LTE, LTETDD
Initial S/W Revision	A.06.00

DL Decode Info

DL Decode Info contains the decoded information from PBCH, PDCCH, PCFICH and PDSCH.

The upper section shows the status of the PBCH, PDCCH, PCFICH, and PDSCH decoders (On or Off).

The lower part of the table shows the decoded information for each frame. The data is color coded to match the color of the corresponding channel in the Frame Summary trace.

See “Data” on page 1181 for the corresponding SCPI command.

A scrollbar will appear when the contents are too long to be displayed in the window. You can scroll the window without a mouse with the following steps.

1. Press **Next Window** key to select the window you want to scroll.
2. Press **Esc** key to turn off the active function
3. Then, press one of **Arrow** keys.

Key Path	Trace/Detector, Data, Tables
Mode	LTE, LTETDD
Initial S/W Revision	A.06.00

UL Decode Info

UL Decode Info contains the decoded information from PUCCH and PUSCH.

The upper section shows the status of the PUCCH and PUSCH decoders (On or Off).

The lower part of the table shows the decoded information for each frame.

See Data section for the corresponding SCPI command.

A scrollbar will appear when the contents are too long to be displayed in the window. You can scroll the window without a mouse with the following steps.

1. Press Next Window key to select the window you want to scroll.
2. Press Esc key to turn off the active function
3. Then, press one of Arrow keys.

Key Path	Trace/Detector, Data, Tables
Mode	LTE, LTETDD
Initial S/W Revision	A.10.00

UE-RS Weights

This table shows the channel response for each subcarrier that is assigned to carry UE-specific reference signal.

See [“Data” on page 1181](#) for the corresponding SCPI command.

A scrollbar will appear when the contents are too long to be displayed in the window. You can scroll the window without a mouse with the following steps.

1. Press **Next Window** key to select the window you want to scroll.
2. Press **Esc** key to turn off the active function
3. Then, press one of **Arrow** keys.

Key Path	Trace/Detector, Data, Tables
----------	------------------------------

Mode	LTETDD
Initial S/W Revision	A.06.00

Response

Displays the Trace Data choices that show equalizer response results.

Key Path	Trace/Detector, Data
Mode	LTE, LTETDD
Initial S/W Revision	Prior to A.02.00
Modified at S/W Revision	A.03.00

Eq Ch Frequency Response

This trace will show the frequency response of the channel derived from the equalizer coefficients, as a function of subcarriers. How the results are computed depends on the choice of Equalizer Training on the Advanced tab. Equalizer training off and that based on RS alone should yield the same trace, while that based on RS+Data should yield a different trace. This is a frequency domain trace coupled only to other frequency domain traces (and not mixed-domain traces).

See “Data” on page 1181 for the corresponding SCPI command.

Key Path	Trace/Detector, Data, Response
Mode	LTE, LTETDD
Initial S/W Revision	Prior to A.02.00
Modified at S/W Revision	A.03.00

Inst Eq Ch Freq Resp

As Eq Ch Frequency Response, but this trace is not averaged.

See “Data” on page 1181 for the corresponding SCPI command.

Key Path	Trace/Detector, Data, Response
Mode	LTE, LTETDD
Initial S/W Revision	Prior to A.02.00
Modified at S/W Revision	A.03.00

Eq Ch Freq Resp Diff

This is the adjacent difference of the channel frequency response. It shows the ratio of the magnitude of the channel response at adjacent subcarriers, expressed in dB so that an ideal response is flat at 0 dB. This trace is real valued. Because this is adjacent differences, the total number of points in the trace is one less than the number of subcarriers. This trace is averaged if averaging is turned on. This is a frequency domain trace coupled only to other frequency domain traces (and not mixed-domain traces).

See “Data” on page 1181 for the corresponding SCPI command.

Key Path	Trace/Detector, Data, Response
Mode	LTE, LTETDD
Initial S/W Revision	Prior to A.02.00
Modified at S/W Revision	A.03.00

Inst Eq Ch Freq Resp Diff

As Eq Ch Resp Diff, but this trace is not averaged. See “Data” on page 1181 for the corresponding SCPI command.

Key Path	Trace/Detector, Data, Response
Mode	LTE, LTETDD
Initial S/W Revision	Prior to A.02.00
Modified at S/W Revision	A.03.00

Eq Impulse Response

This shows the impulse response of the equalization filter. The equalizer impulse response is computed by taking the reciprocal of the channel equalizer frequency response, performing data filtering and computations that produce a result length of 4x the FFT length, and then converting to the time domain. The Eq Impulse Response is the computed channel impulse response used to compensate for signal channel response degradation.

See “Data” on page 1181 for the corresponding SCPI command.

Key Path	Trace/Detector, Data, Response
Mode	LTE, LTETDD
Initial S/W Revision	Prior to A.02.00
Modified at S/W Revision	A.03.00

Eq Ch Freq Resp Per Slot

This shows the frequency response of the channel for each slot in the Measurement Interval.

Each slot's channel frequency response is plotted as a separate line with a different color. The colors have no correspondence to other traces or channels. The colors are only used to visually separate each slot's channel frequency response.

See “Data” on page 1181 for the corresponding SCPI command.

NOTE This trace can be used to measure Spectral Flatness as defined in Section 6.5.2.4 of 3GPP TS 36.521-1.

Key Path	Trace/Detector, Data, Response
Mode	LTE, LTETDD
Initial S/W Revision	Prior to A.02.00
Modified at S/W Revision	A.03.00

MIMO

Displays the Trace Data choices that show MIMO results.

Key Path	Trace/Detector, Data, More
Mode	LTE, LTETDD
Initial S/W Revision	Prior to A.02.00
Modified at S/W Revision	A.03.00

Info Table

The measurement automatically detects the presence of signals from all the antenna ports and measures certain metrics related to them only if the antenna port parameter “[Reference Tx Antenna Port](#)” on [page 867](#) Tx Antenna Port is set to “auto”. The results are reported in the form of the following table. The number of columns depends on the number of transmit antennas selected. Antenna ports that have not contributed to the composite signal have their corresponding columns displayed simply as “---”.

See “[Data](#)” on [page 1181](#) for the corresponding SCPI command.

	Tx0/Rx0	Tx1/Rx0	Tx2/Rx0	Tx3/Rx0
RS Power				
RS EVM				
CPE				
Timing				
Phase				
Freq. Error				
Sym Clock Error				

Key Path	Trace/Detector, Data, MIMO
Mode	LTE, LTETDD
Initial S/W Revision	Prior to A.02.00
Modified at S/W Revision	A.03.00

Ch Freq Resp

This trace shows the channel responses of the paths from all transmitter antenna ports that are auto-detected to exist in the signal. It comprises of up to 4 traces overlaid on top of each other, possibly with some color coding.

See [“Data” on page 1181](#) for the corresponding SCPI command.

Key Path	Trace/Detector, Data, MIMO
Mode	LTE, LTETDD
Initial S/W Revision	Prior to A.02.00
Modified at S/W Revision	A.03.00

Ch Freq Resp Diff

This trace shows the channel response differences of the paths from all transmitter antenna ports that are auto-detected to exist in the signal. It comprises of up to 4 traces overlaid on top of each other, possibly with some color coding.

See [“Data” on page 1181](#) for the corresponding SCPI command.

Key Path	Trace/Detector, Data, MIMO
Mode	LTE, LTETDD
Initial S/W Revision	Prior to A.02.00
Modified at S/W Revision	A.03.00

Eq Impulse Resp

This trace shows the Eq. impulse responses of the paths from all transmitter antenna ports that are auto-detected to exist in the signal. It comprises of up to 4 traces overlaid on top of each other, possibly with some color coding.

See [“Data” on page 1181](#) for the corresponding SCPI command.

Key Path	Trace/Detector, Data, MIMO
Mode	LTE, LTETDD
Initial S/W Revision	Prior to A.02.00
Modified at S/W Revision	A.03.00

MIMO Common Tracking Error

This trace shows the common pilot errors of the paths from all transmitter antenna ports that are auto-detected to exist in the signal. It comprises of up to 4 traces overlaid on top of each other, possibly with some color coding.

See “Data” on page 1181 for the corresponding SCPI command.

Key Path	Trace/Detector, Data, MIMO
Mode	LTE, LTETDD
Initial S/W Revision	Prior to A.02.00
Modified at S/W Revision	A.03.00

ACP

This displays a selection of the ACP result traces. For more information, see Trace/Detector, Data, ACP

Key Path	Trace/Detector, Data, ACP
Mode	LTE, LTETDD
Initial S/W Revision	Prior to A.02.00
Modified at S/W Revision	A.03.00

OBW

This displays a selection of the OBW result traces. For more information, see Analyzer Setup Functions, Trace/Detector, Data, OBW.

Key Path	Trace/Detector, Data, OBW
Mode	LTE, LTETDD
Initial S/W Revision	Prior to A.02.00
Modified at S/W Revision	A.03.00

Register

This displays a selection of the Data Registers. For more information, see Analyzer Setup Functions, Trace/Detector, Data, Register.

Key Path	Trace/Detector, Data, Register
Mode	LTE, LTETDD
Initial S/W Revision	Prior to A.02.00
Modified at S/W Revision	A.03.00

No Data

A blank display is shown. For more information, see Analyzer Setup Functions, Trace/Detector, Data, No Data

Key Path	Trace/Detector, Data, No Data
----------	--------------------------------------

Mode	LTE, LTETDD
Initial S/W Revision	Prior to A.02.00
Modified at S/W Revision	A.03.00

Trigger

Displays a menu that enables you to select Trigger Source and control triggering parameters. Trigger Source selection is a measurement local parameter, can be set to each measurement individually. Trigger Source selection for this measurement is Free Run, Video (IF Envelope) and External 1 as follows:

Triggering is used to determine when a measurement should start taking data. There are several available trigger sources. For each trigger source, there are associated setup parameters. Typically, a trigger event is generated when a signal (or a characteristic of the signal) crosses a defined trigger level (or threshold) on a rising or falling slope. The measurement begins at a specified time delay from the trigger point. The delay may be negative, enabling pre-trigger data to be taken. Each trigger source has associated its own trigger level, slope, and delay settings.

See [“Trigger” on page 1770](#) for more information.

Key Path	Trigger
Mode	LTE, LTETDD
Initial S/W Revision	Prior to A.02.00
Modified at S/W Revision	A.03.00

View/Display

LTE Modulation Analysis results may be displayed in any trace, and the traces viewed in a variety of layouts that show 1, 2, 3, or 4 traces at a time. Each trace may be scaled as desired regardless of measurement settings, or auto-scaled to reflect measurement settings. Data may be formatted in a variety of ways. (For example, you may view the log magnitude of complex data, the real or imaginary part, etc.) You may use Basic or other Preset Views to view frequently used results, or to provide a familiar starting point from which you may customize your own view.

The view setup can be changed by selections from the View/Display menu, including by pressing View Preset: Basic.

See [“View/Display” on page 1786](#) for more information.

Key Path	Front-panel key
Mode	LTE, LTETDD
Initial S/W Revision	Prior to A.02.00
Modified at S/W Revision	A.03.00

Display

Invokes the View/Display, Display menu. For more information, see View/Display, Key and Command Description, Display section.

See [“View/Display” on page 1786](#) for more information.

Key Path	View/Display
Mode	LTE, LTETDD
Initial S/W Revision	Prior to A.02.00
Modified at S/W Revision	A.03.00

Layout

Invokes the View/Display, Layout menu.

See [“Layout” on page 1786](#) for more information.

Key Path	View/Display
Mode	LTE, LTETDD
Initial S/W Revision	Prior to A.02.00
Modified at S/W Revision	A.03.00

Preset View

This command displays Preset Views that provide a set of trace data displays designed to help accomplish a specific measurement objective. The details of each Preset View are provided in the Help for the individual views.

Key Path	(SCPI only)
Mode	LTE, LTETDD
Remote Command	:DISPlay:EVM:VIEW:PRESet BASic SUMMary RBSLot SUBCarrier MIMO
Example	DISP:EVM:VIEW:PRES BAS
Preset	BASic
Initial S/W Revision	Prior to A.02.00
Modified at S/W Revision	A.03.00

Preset View: Basic

This preset view consists of the following traces in a Grid 2x2 layout:

1. IQ Meas
2. Spectrum
3. Error Vector Spectrum
4. Error Summary

This layout is set by Meas Preset and is good for insuring that the signal is being demodulated correctly, as well as showing many basic demodulation setup problems.

The Preset View: Basic softkey performs the immediate action of changing the layout and view to this configuration. Preset View is an action, not a state.

Key Path	View/Display
Mode	LTE, LTETDD
Remote Command	:DISPlay:EVM:VIEW:PRESet BASic
Example	DISP:EVM:VIEW:PRES BAS
Initial S/W Revision	Prior to A.02.00
Modified at S/W Revision	A.03.00

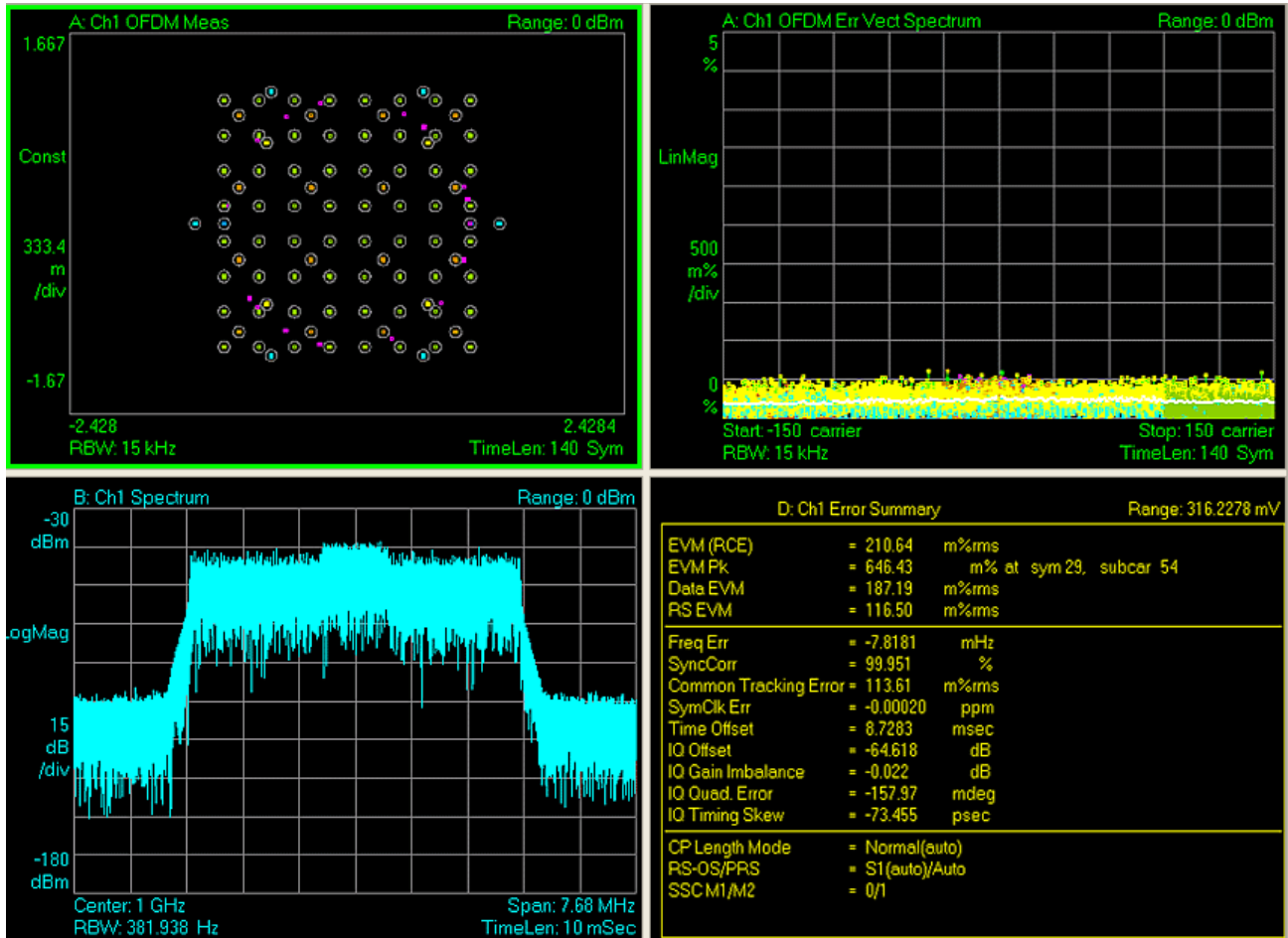

Preset View: Meas Summary

This preset view consists of the following traces in a Stacked layout:

1. Error Summary
2. Frame Summary

This layout provides the full list of the composite result metrics and characteristics of each of the logical channels.

The Preset View: Meas Summary softkey performs the immediate action of changing the layout and view to this configuration. Preset View is an action, not a state.

Key Path	View/Display
Mode	LTE, LTETDD
Remote Command	:DISPlay:EVM:VIEW:PRESet SUMMary
Example	DISP:EVM:VIEW:PRES SUMM
Initial S/W Revision	Prior to A.02.00

Modified at S/W Revision	A.03.00
--------------------------	---------

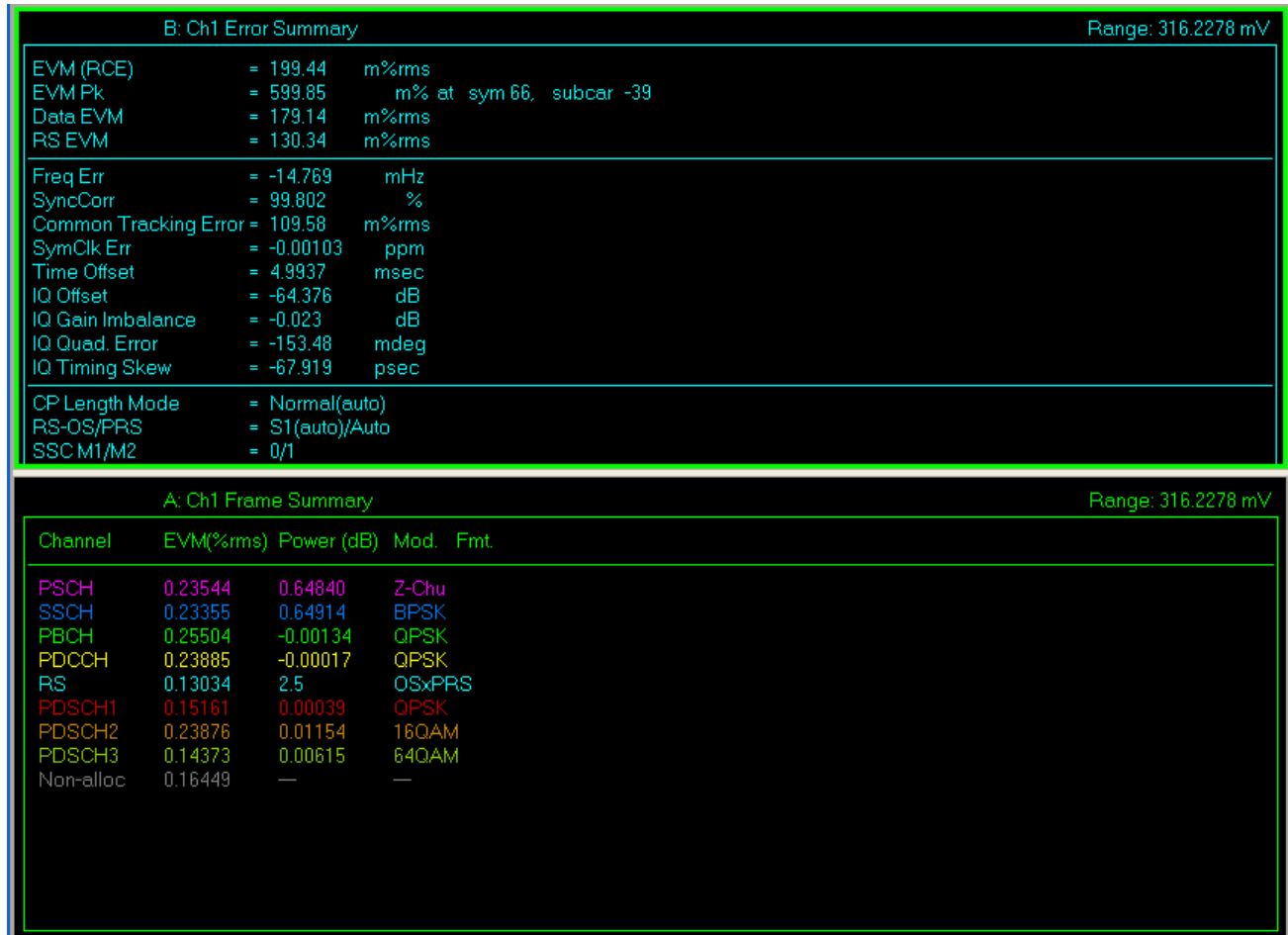

Preset View: RB Slot Meas

This preset view consists of the following traces in a Grid 2x2 layout:

1. RB Power vs Spectrum
2. RB Error Mag Spectrum
3. RB Power vs Time
4. RB Error Mag Time

This layout provides the details on the Resource Block.

The Preset View: RB Slot Meas softkey performs the immediate action of changing the layout and view to this configuration. Preset View is an action, not a state.

Key Path	View/Display
Mode	LTE, LTETDD

Remote Command	:DISPlay:EVM:VIEW:PRESet RBSPlot
Example	DISP:EVM:VIEW:PRE RBSP
Initial S/W Revision	Prior to A.02.00
Modified at S/W Revision	A.03.00

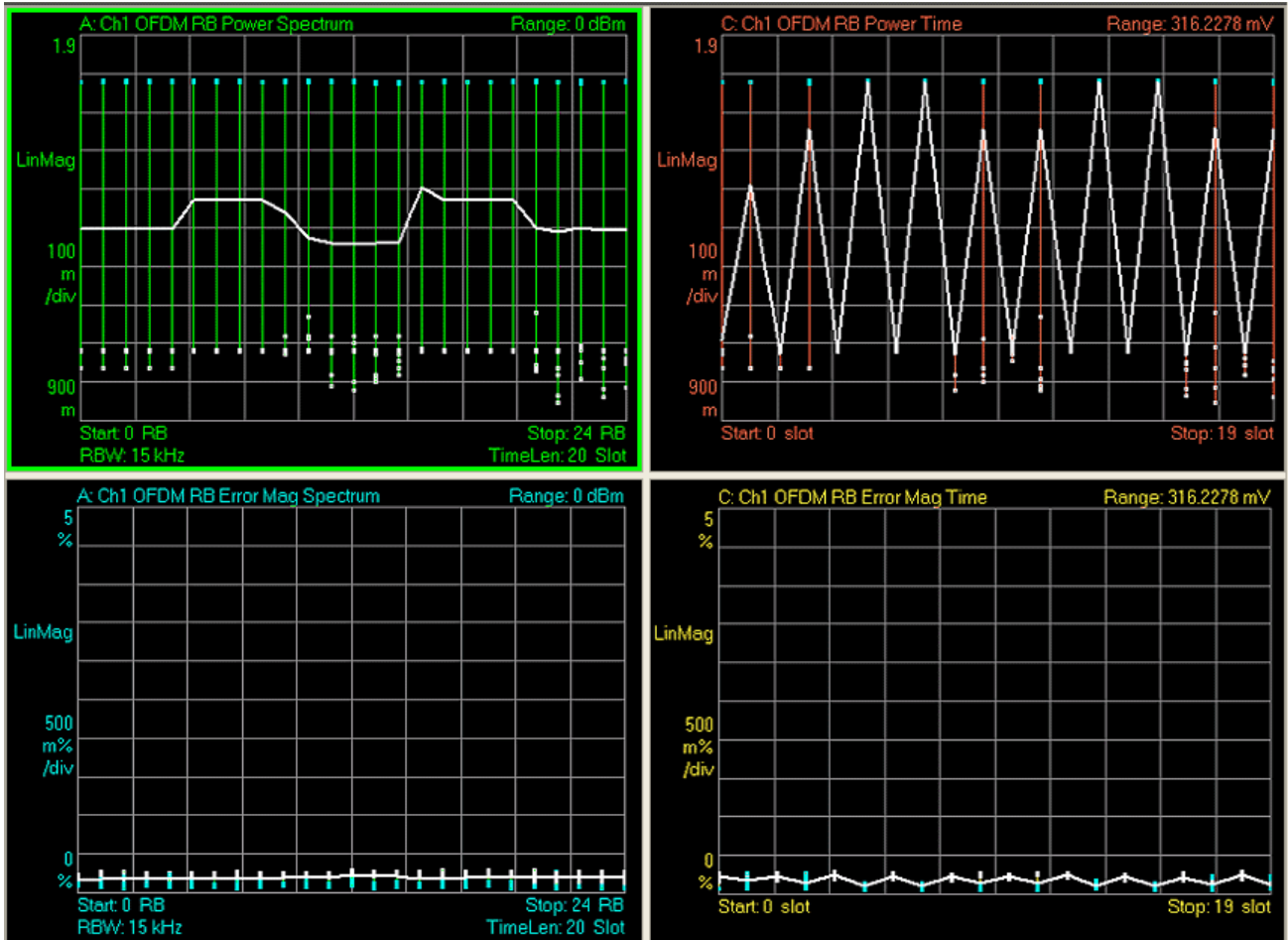

Preset View: Subcarrier Meas

This preset view consists of the following traces in a Grid 2x2 layout:

- Error Vector Spectrum
- IQ Meas (Log Mag)
- Error Vector Time
- IQ Meas Time (Log Mag)

This layout provides the details on the Power and EVM results.

The Preset View: Subcarrier Meas softkey performs the immediate action of changing the layout and

LTE Modulation Analysis Measurement
View/Display

view to this configuration. Preset View is an action, not a state.

Key Path	View/Display, More
Mode	LTE, LTETDD
Remote Command	:DISPlay:EVM:VIEW:PRESet SUBCarrier
Example	DISP:EVM:VIEW:PRES SUBC
Initial S/W Revision	Prior to A.02.00
Modified at S/W Revision	A.03.00

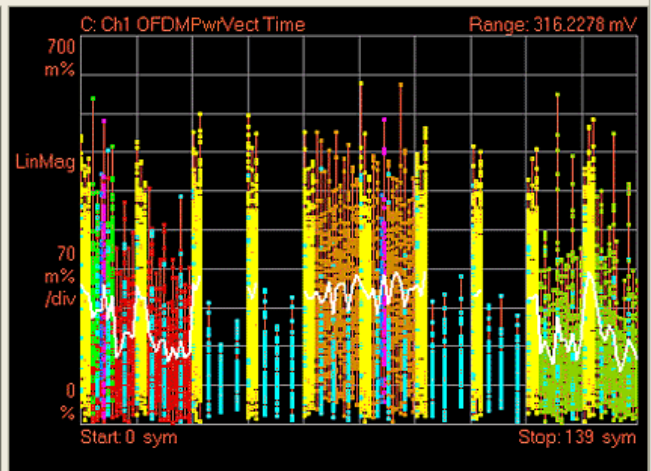
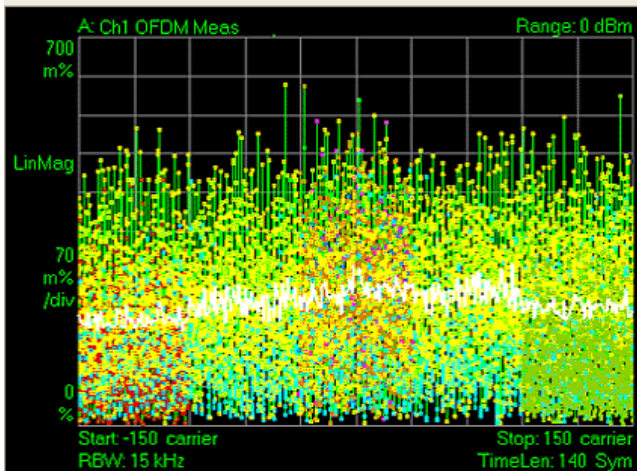
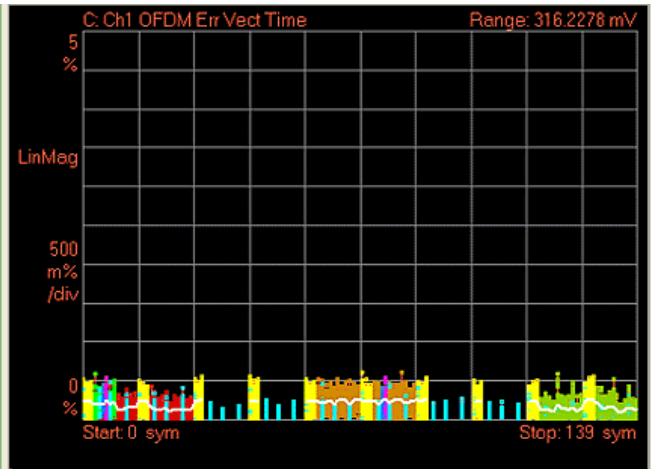
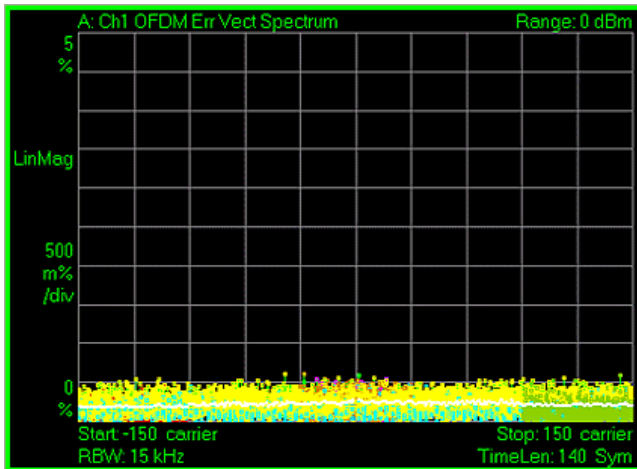

Preset View: MIMO Summary

This preset view consists of the following traces in a Stacked layout:

1. MIMO Info Table
2. Chan Freq Resp

This layout provides the details on the MIMO results.

The Preset View: MIMO Summary softkey performs the immediate action of changing the layout and view to this configuration. Preset View is an action, not a state.

Key Path	View/Display, More
Mode	LTE, LTETDD
Remote Command	:DISP:lay:EVM:VIEW:PRESet MIMO
Example	DISP:EVM:VIEW:PRES MIMO
Dependencies	Available only when Direction is Downlink.
Initial S/W Revision	Prior to A.02.00
Modified at S/W Revision	A.03.00

The monitor spectrum measurement is used as a quick, convenient means of looking at the entire spectrum. While the look and feel are similar to the Spectrum Analyzer mode, the functionality is greatly reduced for easy operation. The main purpose of the measurement is to show the spectrum. The default span should cover an appropriate frequency range of the application. For measurement results and views, see [“View/Display” on page 1263](#).

For information on how to make measurement using the X-Series Signal Analyzer, see:

Measurement Guide [n9080-90006.pdf].

This topic contains the following sections:

[“Measurement Commands for Monitor Spectrum” on page 1217](#)

[“Remote Command Results for Monitor Spectrum Measurement” on page 1217](#)

Measurement Commands for Monitor Spectrum

The following commands can be used to retrieve the measurement results:

:CONFigure:MONitor

:CONFigure:MONitor:NDEFault

:INITiate:MONitor

:FETCh:MONitor[n]?

:READ:MONitor[n]?

:MEASure:MONitor[n]?

For more measurement related commands, see the SENSE subsystem, and the section [“Remote Measurement Functions” on page 1520](#).

Remote Command Results for Monitor Spectrum Measurement

n	Results Returned
n=1 (or not specified)	Returns trace1 data with comma separated floating numbers
n=2	Returns trace2 data with comma separated floating numbers
n=3	Returns trace3 data with comma separated floating numbers

Key Path	Meas
Initial S/W Revision	Prior to A.02.00

AMPTD Y Scale

Accesses a menu of functions that enable you to set the vertical scale parameters. These functions control how data on the vertical (Y) axis is displayed and control instrument settings that affect the vertical axis.

Key Path	Front-panel key
Initial S/W Revision	Prior to A.02.00

Ref Value

Sets the absolute power reference value. However, since the Auto Scaling is defaulted to On, this value is automatically determined by the measurement result. When you set a value manually, Auto Scaling automatically changes to Off.

Key Path	AMPTD Y Scale
Mode	All except SA and BASIC
Remote Command	:DISPlay:MONitor:VIEW[1]:WINDow[1]:TRACe:Y[:SCALE]:RLEV el <real> :DISPlay:MONitor:VIEW[1]:WINDow[1]:TRACe:Y[:SCALE]:RLEV el?
Example	DISP:MON:VIEW:WIND:TRAC:Y:RLEV 2.0 DISP:MON:VIEW:WIND:TRAC:Y:RLEV?
Couplings	When the Auto Scaling is On, this value is automatically determined by the measurement result. When you set a value manually, Auto Scaling automatically changes to Off.
Preset	10.00 dBm
State Saved	Saved in instrument state.
Min	-250.00 dBm
Max	250.00 dBm
Initial S/W Revision	Prior to A.02.00

Attenuation

Accesses a menu of functions that enable you to change the attenuation settings.

See AMPTD Y Scale, “Attenuation” on page 1381 for more information.

Key Path	AMPTD Y Scale
----------	----------------------

Initial S/W Revision	Prior to A.02.00
----------------------	------------------

Scale/Div

Sets the logarithmic units per vertical graticule division on the display. However, since the Auto Scaling is defaulted to On, this value is automatically determined by the measurement result. When you set a value manually, Auto Scaling automatically changes to Off.

Key Path	AMPTD Y Scale
Mode	All except SA and BASIC
Remote Command	:DISPlay:MONitor:VIEW[1]:WINDow[1]:TRACe:Y[:SCALe]:PDIV ision <rel_ampl> :DISPlay:MONitor:VIEW[1]:WINDow[1]:TRACe:Y[:SCALe]:PDIV ision?
Example	DISP:MON:VIEW:WIND:TRAC:Y:PDIV 5.0 dB DISP:MON:VIEW:WIND:TRAC:Y:PDIV?
Couplings	When the Auto Scaling is On, this value is automatically determined by the measurement result. When you set a value manually, Auto Scaling automatically changes to Off.
Preset	10.00 dB
State Saved	Saved in instrument state.
Min	0.10 dB
Max	20.00 dB
Initial S/W Revision	Prior to A.02.00

Presel Center

See AMPTD Y Scale, “[Presel Center](#)” on page 1396 for more information.

Presel Adjust

See AMPTD Y Scale, “[Preselector Adjust](#)” on page 1398 for more information.

μW Path Control

The **μW Path Control** functions include the **μW Preselector Bypass** (Option MPB) and **Low Noise Path** (Option LNP) controls in the High Band path circuits.

See “[μW Path Control](#)” on page 1405 under the AMPTD Y Scale section for more information.

Internal Preamp

Accesses a menu of functions that enable you to control the internal preamplifiers.

Monitor Spectrum Measurement
AMPTD Y Scale

See AMPTD Y Scale, “Internal Preamplifier” on page 1410 for more information.

Key Path	AMPTD Y Scale
Initial S/W Revision	Prior to A.02.00

Ref Position

Positions the reference level at the top, center or bottom of the Y Scale display. Changing the reference position does not change the reference level value.

Key Path	AMPTD Y Scale
Mode	All except SA and BASIC
Remote Command	:DISPlay:MONitor:VIEW[1]:WINDow[1]:TRACe:Y[:SCALE]:RPOS ition TOP CENTer BOTTom :DISPlay:MONitor:VIEW[1]:WINDow[1]:TRACe:Y[:SCALE]:RPOS ition?
Example	DISP:MON:VIEW:WIND:TRAC:Y:RPOS CENT DISP:MON:VIEW:WIND:TRAC:Y:RPOS?
Preset	TOP
State Saved	Saved in instrument state.
Range	Top Ctr Bot
Initial S/W Revision	Prior to A.02.00

Auto Scaling

Toggles the Auto Scaling function between On and Off.

Key Path	AMPTD Y Scale
Mode	All except SA and BASIC
Remote Command	:DISPlay:MONitor:VIEW[1]:WINDow[1]:TRACe:Y[:SCALE]:COUP le 0 1 OFF ON :DISPlay:MONitor:VIEW[1]:WINDow[1]:TRACe:Y[:SCALE]:COUP le?
Example	DISP:MON:VIEW:WIND:TRAC:Y:COUP ON DISP:MON:VIEW:WIND:TRAC:Y:COUP?
Couplings	When Auto Scaling is On, and the Restart front-panel key is pressed, this function automatically determines the scale per division and reference values based on the measurement results. When you set a value to either Scale/Div or Ref Value manually, Auto Scaling automatically changes to Off.

Preset	ON
State Saved	Saved in instrument state.
Range	On Off
Initial S/W Revision	Prior to A.02.00

Auto Couple

See “Auto Couple” on page 1412 for more information.

Key Path	Front-panel key
----------	-----------------

BW

Accesses a menu that enables you to specify the resolution bandwidth functions that control the bandwidth and filter selection.

Key Path	Front-panel key
Initial S/W Revision	Prior to A.02.00

Res BW

Sets the resolution bandwidth for the current measurement. If an unavailable bandwidth is entered with the numeric keypad, the closest available bandwidth is selected.

Key Path	BW
Mode	All except SA and BASIC
Remote Command	[:SENSE]:MONitor:BANDwidth[:RESolution] <freq> [:SENSE]:MONitor:BANDwidth[:RESolution]? [:SENSE]:MONitor:BANDwidth[:RESolution]:AUTO OFF ON 0 1 [:SENSE]:MONitor:BANDwidth[:RESolution]:AUTO?
Example	MON:BAND 2.4 MHz MON:BAND? MON:BAND:AUTO ON MON:BAND:AUTO?

Monitor Spectrum Measurement
BW

Preset	WCDMA: Automatically calculated WIMAX OFDMA: 100kHz C2K: Automatically calculated BLUETOOTH: Automatically calculated PN: Automatically calculated GSM/EDGE: Automatically calculated TD-SCDMA: Automatically calculated 1xEVDO: 30kHz DVB-T/H: 3.9kHz DTMB (CTTB): 3.9kHz ISDB-T: 3.9kHz CMMB: 3.9kHz LTE: 100 kHz LTETDD: 100 kHz Digital Cable TV: 3.9kHz WLAN: 100 kHz MSR: Automatically calculated WCDMA: ON WIMAX: OFF C2K: ON BLUETOOTH: ON PN: ON GSM/EDGE: ON TD-SCDMA: ON 1xEVDO: ON DVB-T/H: OFF DTMB (CTTB): OFF ISDB-T: OFF CMMB: OFF LTE:OFF LTETDD: OFF Digital Cable TV: OFF WLAN: OFF MSR: ON
State Saved	Saved in instrument state.

Min	1.0 Hz
Max	8.0 MHz
Backwards Compatibility SCPI	[[:SENSe]:MONitor:BWIDth[:RESolution]
Initial S/W Revision	Prior to A.02.00
Modified at S/W Revision	A.02.00
Modified at S/W Revision	A.03.00

Video BW

Changes the analyzer post-detection filter.

Key Path	BW
Mode	All except SA and BASIC
Remote Command	[[:SENSe]:MONitor:bandwidth:VIDeo <bandwidth> [:SENSe]:MONitor:bandwidth:VIDeo? [:SENSe]:MONitor:bandwidth:VIDeo:AUTO ON OFF 1 0 [:SENSe]:MONitor:bandwidth:VIDeo:AUTO?
Example	MON:BAND:VID 10 MHz MON:BAND:VID? MON:BAND:VID:AUTO OFF MON:BAND:VID:AUTO?

Monitor Spectrum Measurement
BW

Preset	WCDMA: Automatically calculated WIMAX OFDMA: 1MHz C2K: Automatically calculated BLUETOOTH: Automatically calculated PN: Automatically calculated GSM/EDGE: Automatically calculated TD-SCDMA: Automatically calculated 1xEVDO: 300kHz DVB-T/H: 39kHz DTMB (CTTB): 39kHz ISDB-T: 39kHz CMMB: 39kHz LTE: 1 MHz LTETDD: 1 MHz Digital Cable TV: 39kHz WLAN: 1 MHz MSR: Automatically calculated WCDMA: ON WIMAX: OFF C2K: ON BLUETOOTH: ON PN: ON GSM/EDGE: ON TD-SCDMA: ON 1xEVDO: ON DVB-T/H: OFF DTMB (CTTB): OFF ISDB-T: OFF CMMB: OFF LTE:OFF LTETDD:OFF Digital Cable TV: OFF WLAN: OFF MSR: ON
State Saved	Saved in instrument state.

Min	1 Hz
Max	50 MHz
Backwards Compatibility SCPI	[:SENSe]:MONitor:BWIDth:VIDeo
Initial S/W Revision	Prior to A.02.00
Modified at S/W Revision	A.02.00
Modified at S/W Revision	A.03.00

VBW:3dB RBW

Selects the ratio between the video bandwidth and the equivalent 3 dB resolution bandwidth to be used for setting the VBW when VBW is in Auto.

Key Path	BW
Mode	All except SA and BASIC
Remote Command	[:SENSe]:MONitor:Bandwidth:VIDeo:Ratio <real> [:SENSe]:MONitor:Bandwidth:VIDeo:Ratio? [:SENSe]:MONitor:Bandwidth:VIDeo:Ratio:AUTO OFF ON 0 1 [:SENSe]:MONitor:Bandwidth:VIDeo:Ratio:AUTO?
Example	MON:BAND:VID:RAT 2 MON:BAND:VID:RAT? MON:BAND:VID:RAT:AUTO 0 MON:BAND:VID:RAT:AUTO?
Preset	1 ON
State Saved	Saved in instrument state.
Min	0.00001
Max	3000000
Backwards Compatibility SCPI	[:SENSe]:MONitor:BWIDth:VIDeo:Ratio
Initial S/W Revision	Prior to A.02.00

Span:3dB RBW

Selects the ratio between span and resolution bandwidth.

The default setting is Auto with a Span:3 dB RBW ratio of 106:1. You can manually change this ratio by

Monitor Spectrum Measurement
BW

pressing the key, entering a new value, and pressing Enter.

Key Path	BW
Mode	All except SA and BASIC
Remote Command	<pre>[:SENSe]:MONitor:FREQuency:SPAN:BANDwidth[:RESolution]: RATio <integer> [:SENSe]:MONitor:FREQuency:SPAN:BANDwidth[:RESolution]: RATio? [:SENSe]:MONitor:FREQuency:SPAN:BANDwidth[:RESolution]: RATio:AUTO OFF ON 0 1 [:SENSe]:MONitor:FREQuency:SPAN:BANDwidth[:RESolution]: RATio:AUTO?</pre>
Example	<pre>MON:FREQ:SPAN:BAND:RAT 200 MON:FREQ:SPAN:BAND:RAT? MON:FREQ:SPAN:BAND:RAT:AUTO ON MON:FREQ:SPAN:BAND:RAT:AUTO?</pre>
Preset	<pre>106 ON</pre>
State Saved	Saved in instrument state.
Min	2
Max	10000
Backwards Compatibility SCPI	[:SENSe]:MONitor:FREQuency:SPAN:BWIDth[:RESolution]:RATio
Initial S/W Revision	Prior to A.02.00
Modified at S/W Revision	A.04.00

Cont

See “[Cont \(Continuous Measurement/Sweep\)](#)” on page 1413 for more information.

Key Path	Front-panel key
----------	-----------------

FREQ Channel

See “[FREQ Channel](#)” on page 1414 for more information.

Key Path	Front-panel key
----------	-----------------

Input/Output

See [“Input/Output” on page 1422](#) for more information.

Key Path	Front-panel key
----------	-----------------

Marker

Accesses a menu that enables you to select, set up and control the markers for the current measurement.

See the "Marker Functions" section for more information

Key Path	Front-panel key
Initial S/W Revision	Prior to A.02.00

Select Marker

Displays 12 markers available for selection.

Key Path	Marker
Initial S/W Revision	Prior to A.02.00

Marker Type

Sets the marker control mode to **Normal**, **Delta** or **Off**. If the selected marker is Off, pressing Marker sets it to Normal and places a single marker at the center of the display. At the same time, **Marker X Axis Value** appears on the Active Function area.

Key Path	Marker
Mode	All except SA and BASIC
Remote Command	:CALCulate:MONitor:MARKer[1] 2 3 4 5 6 7 8 9 10 11 12:MODE POSition DELTA OFF :CALCulate:MONitor:MARKer[1] 2 3 4 5 6 7 8 9 10 11 12:MODE?
Example	CALC:MON:MARK:MODE POS CALC:MON:MARK:MODE?
Notes	If the selected marker is Off, pressing Marker sets it to Normal and places it at the center of the screen on the trace determined by the Marker Trace rules. At the same time, Marker X Axis Value appears on the Active Function area. Default Active Function: the active function for the selected marker's current control mode. If the current control mode is Off, there is no active function and the active function is turned off. Active Function Display: the marker X axis value entered in the active function area displays the marker value to its full entered precision.
Preset	OFF
State Saved	Saved in instrument state.

Range	Normal Delta Off
Initial S/W Revision	Prior to A.02.00

Marker X Axis Value (Remote Command only)

Sets the marker X Axis value in the current marker X Axis Scale unit. It has no effect if the control mode is **Off**, but is the SCPI equivalent of entering an X value if the control mode is **Normal** or **Delta**.

Mode	All except SA and BASIC
Remote Command	:CALCulate:MONitor:MARKer[1] 2 3 4 5 6 7 8 9 10 11 12:X <freq> :CALCulate:MONitor:MARKer[1] 2 3 4 5 6 7 8 9 10 11 12:X ?
Example	CALC:MON:MARK3:X 0 CALC:MON:MARK3:X?
Notes	If no suffix is sent, uses the fundamental units for the current marker X Axis Scale. If a suffix is sent that does not match the current marker X Axis Scale unit, an error “Invalid suffix” is generated. The query returns the marker’s absolute X Axis value if the control mode is Normal , or the offset from the marker’s reference marker if the control mode is Delta . The query is returned in the fundamental units for the current marker X Axis scale: Hz for Frequency and Inverse Time , seconds for Period and Time . If the marker is Off the response is not a number.
Preset	After a preset, all markers are turned OFF, so Marker X Axis Value query returns a not a number (NAN).
State Saved	No
Min	-9.9E+37
Max	9.9E+37
Initial S/W Revision	Prior to A.02.00

Marker X Axis Position (Remote Command only)

Sets the marker X position in trace points. It has no effect if the control mode is **Off**, but is the SCPI equivalent of entering a value if the control mode is **Normal** or **Delta** – except in trace points rather than X Axis Scale units. The entered value is immediately translated into the current X Axis Scale units for setting the value of the marker.

Mode	All except SA and BASIC
Remote Command	:CALCulate:MONitor:MARKer[1] 2 3 4 5 6 7 8 9 10 11 12:X :POSition <real> :CALCulate:MONitor:MARKer[1] 2 3 4 5 6 7 8 9 10 11 12:X :POSition?

Monitor Spectrum Measurement
Marker

Example	CALC:MON:MARK:X:POS 0 CALC:MON:MARK:X:POS?
Notes	The query returns the marker's absolute X Axis value in trace points if the control mode is Normal , or the offset from the marker's reference marker in trace points if the control mode is Delta . The value is returned as a real number, not an integer, corresponding to the translation from X Axis Scale units to trace points. If the marker is Off the response is not a number.
Preset	After a preset, all markers are turned OFF, so Marker X Axis Value query returns a not a number (NAN).
State Saved	No
Min	-9.9E+37
Max	9.9E+37
Initial S/W Revision	Prior to A.02.00

Marker Y Axis Value (Remote Command only)

Returns the marker Y Axis value in the current marker.

Mode	All except SA and BASIC
Remote Command	:CALCulate:MONitor:MARKer[1] 2 3 4 5 6 7 8 9 10 11 12:Y?
Example	CALC:MON:MARK11:Y?
Preset	Result dependant on markers setup and signal source
Backwards Compatibility SCPI	:CALCulate:MONitor:MARKer[1] 2 3 4 5 6 7 8 9 10 11 12:FUNCTION:RESult?
Initial S/W Revision	Prior to A.02.00

Properties

Accesses a menu that enables you to select the active marker, the reference marker and the trace for the current measurement.

Key Path	Marker
Initial S/W Revision	Prior to A.02.00

Select Marker

Displays 12 markers available for selection.

Key Path	Marker
Initial S/W Revision	Prior to A.02.00

Relative To

Selects the desired marker. The selected marker is relative to its reference marker

Key Path	Marker, Properties
Mode	All except SA and BASIC
Remote Command	:CALCulate:MONitor:MARKer[1] 2 3 4 5 6 7 8 9 10 11 12:REFerence <integer> :CALCulate:MONitor:MARKer[1] 2 3 4 5 6 7 8 9 10 11 12:REFerence?
Example	CALC:MON:MARK2:REF 1 CALC:MON:MARK2:REF?
Notes	A marker cannot be relative to itself so that choice is grayed out, and if sent from SCPI generates error -221: "Settings conflict; marker cannot be relative to itself." When queried a single value is returned (the specified marker number's relative marker).
Preset	2 3 4 5 6 7 8 9 10 11 12 1
State Saved	Saved in instrument state.
Min	1
Max	12
Initial S/W Revision	Prior to A.02.00

Marker Trace

Assigns the specified marker to the designated trace.

Key Path	Marker, Properties
Mode	All except SA and BASIC
Remote Command	:CALCulate:MONitor:MARKer[1] 2 3 4 5 6 7 8 9 10 11 12:TRACe <integer> :CALCulate:MONitor:MARKer[1] 2 3 4 5 6 7 8 9 10 11 12:TRACe?
Example	CALC:MON:MARK:TRAC 1 CALC:MON:MARK:TRAC?
Preset	1
State Saved	Saved in instrument state.
Min	1
Max	3

Initial S/W Revision	Prior to A.02.00
----------------------	------------------

Couple Markers

When this function is true, moving any marker causes an equal X Axis movement of every other marker which is not **Off**. By “equal X Axis movement” we mean that we preserve the difference between each marker’s X Axis value (in the fundamental x–axis units of the trace that marker is on) and the X Axis value of the marker being moved (in the same fundamental x–axis units).

Key Path	Marker
Mode	All except SA and BASIC
Remote Command	:CALCulate:MONitor:MARKer:COUPle[:STATE] ON OFF 1 0 :CALCulate:MONitor:MARKer:COUPle[:STATE]?
Example	CALC:MON:MARK:COUP ON CALC:MON:MARK:COUP?
Preset	OFF
State Saved	Saved in instrument state.
Range	On Off
Initial S/W Revision	Prior to A.02.00

All Markers Off

Turns off all markers on the current measurement.

Key Path	Marker
Mode	All except SA and BASIC
Remote Command	:CALCulate:MONitor:MARKer:AOFF
Example	CALC:MON:MARK:AOFF
Initial S/W Revision	Prior to A.02.00

Marker Function

Accesses special marker functions such as marker noise, and power in a specified bandwidth or time interval.

Key Path	Front-panel key
Initial S/W Revision	Prior to A.02.00

Select Marker

Selects one of the 12 available markers.

Key Path	Marker Function
Initial S/W Revision	Prior to A.02.00

Marker Function Type

Sets the marker control function type to, Marker Noise, Band/Interval Power, Band Interval Density, or Marker Function Off.

Key Path	Marker Function
Mode	All except SA and BASIC
Remote Command	:CALCulate:MONitor:MARKer[1] 2 3 4 5 6 7 8 9 10 11 12:F UNction NOISe BPOwer BDENsity OFF :CALCulate:MONitor:MARKer[1] 2 3 4 5 6 7 8 9 10 11 12:F UNction?
Example	CALC:MON:MARK:FUNC NOIS CALC:MON:MARK:FUNC?
Preset	OFF
State Saved	Saved in instrument state.
Range	Marker Noise Band/Interval Power Band Interval Density Marker Function Off
Initial S/W Revision	Prior to A.02.00

Band Adjust

Accesses a menu that enables you to set the frequency span width and the left and right edge, or time values, for the band or interval of the selected marker.

Key Path	Marker Function
----------	------------------------

Monitor Spectrum Measurement
Marker Function

Initial S/W Revision	Prior to A.02.00
----------------------	------------------

Band/Interval Span for Frequency Domain

Sets the width of the frequency span for the selected marker.

Key Path	Marker Function
Mode	All except SA and BASIC
Remote Command	:CALCulate:MONitor:MARKer[1] 2 3 4 5 6 7 8 9 10 11 12:F UNction:BAND:SPAN <freq> :CALCulate:MONitor:MARKer[1] 2 3 4 5 6 7 8 9 10 11 12:F UNction:BAND:SPAN?
Example	CALC:MON:MARK12:FUNC:BAND:SPAN 20 MHz CALC:MON:MARK12:FUNC:BAND:SPAN?
Couplings	Changing the Band/Interval Span necessarily changes the Band/Interval Left and Band/Interval Right values.
Preset	Depends on X axis range of selected Trace.
State Saved	Saved in instrument state.
Min	-9.9E+37
Max	9.9E+37
Initial S/W Revision	Prior to A.02.00

Band/Interval Left for Frequency Domain

Sets the left edge frequency or time value for the band of the selected marker.

Key Path	Marker Function
Mode	All except SA and BASIC
Remote Command	:CALCulate:MONitor:MARKer[1] 2 3 4 5 6 7 8 9 10 11 12:F UNction:BAND:LEFT <freq> :CALCulate:MONitor:MARKer[1] 2 3 4 5 6 7 8 9 10 11 12:F UNction:BAND:LEFT?
Example	CALC:MON:MARK12:FUNC:BAND:LEFT 20 GHz CALC:MON:MARK12:FUNC:BAND:LEFT?
Couplings	Changing the Band/Interval Left necessarily changes the Band/Interval Span and Band/Interval Right values.
Preset	Depends on X axis range of selected Trace.
State Saved	Saved in instrument state.
Min	-9.9E+37

Max	9.9E+37
Initial S/W Revision	Prior to A.02.00

Band/Interval Right for Frequency Domain

Sets the right edge frequency or time value for the band of the selected marker.

Key Path	Marker Function
Mode	All except SA and BASIC
Remote Command	:CALCulate:MONitor:MARKer[1] 2 3 4 5 6 7 8 9 10 11 12:F UNction:BAND:RIGHT <freq> :CALCulate:MONitor:MARKer[1] 2 3 4 5 6 7 8 9 10 11 12:F UNction:BAND:RIGHT?
Example	CALC:MON:MARK12:FUNC:BAND:RIGH 20 GHz CALC:MON:MARK12:FUNC:BAND:RIGH?
Couplings	Changing the Band/Interval Right necessarily changes the Band/Interval Left and Band/Interval Span values
Preset	Depends on X axis range of selected Trace.
State Saved	Saved in instrument state.
Min	-9.9E+37
Max	9.9E+37
Initial S/W Revision	Prior to A.02.00

Marker To

There is no 'Marker To' functionality supported in Monitor Spectrum. The front-panel key displays a blank menu key when pressed.

Key Path	Front-panel key
Initial S/W Revision	Prior to A.02.00

Meas

See “[Meas](#)” on page 1520 for more information.

Key Path	Front-panel key
----------	-----------------

Meas Setup

Displays the setup menu for the current measurement. The measurement setup parameters include the number of measurement averages used to calculate the measurement result and the averaging mode. The setup menu also includes the option to reset the measurement settings to their factory defaults.

Key Path	Front-panel key
Initial S/W Revision	Prior to A.02.00

Avg/Hold Num

Specifies the number of measurement averages used when calculating the measurement result. The average is displayed at the end of each sweep.

After the specified number of average counts, the averaging mode (terminal control) setting determines the averaging action.

Key Path	Meas Setup
Mode	All except SA and BASIC
Remote Command	[:SENSE]:MONitor:AVERage:COUNT <integer> [:SENSE]:MONitor:AVERage:COUNT? [:SENSE]:MONitor:AVERage[:STATe] OFF ON 0 1 [:SENSE]:MONitor:AVERage[:STATe]?
Example	MON:AVER:COUN 25 MON:AVER:COUN? MON:AVER ON MON:AVER?
Preset	10 OFF
State Saved	Saved in instrument state.
Min	1
Max	1000
Initial S/W Revision	Prior to A.02.00

Avg Mode

Toggles the average mode between exponential (Exp) and Repeat.

Exp- continues measurement averaging, using the specified number of averages to compute each averaged value. The average is displayed at the end of each sweep.

Repeat- causes the measurement to reset the average counter each time the specified number of averages is reached.

Key Path	Meas Setup
Mode	All except SA and BASIC
Remote Command	[:SENSe]:MONitor:AVERage:TCONtrol EXPonential REPEAT [:SENSe]:MONitor:AVERage:TCONtrol?
Example	MON:AVER:TCON EXP MON:AVER:TCON?
Preset	EXPonential
State Saved	Saved in instrument state.
Range	ExpRepeat
Initial S/W Revision	Prior to A.02.00

Meas Preset

Restores all the measurement parameters to their default values.

Key Path	Meas Setup
Mode	All except SA and BASIC
Remote Command	:CONFigure:MONitor
Example	CONF:MON
Initial S/W Revision	Prior to A.02.00

Mode

See “[Mode](#)” on page 1534 for more information.

Key Path	Front-panel key
----------	-----------------

Mode Setup

See “[Mode Setup](#)” on page 1553 for more information.

Key Path	Front-panel key
----------	-----------------

Peak Search

Places the selected marker on the trace point with the maximum y-axis value for that marker's trace. Pressing Peak Search with the selected marker off causes the selected marker to be set to Normal, then a peak search is immediately performed. ak Search

Key Path	Front-panel key
Mode	All except SA and BASIC
Remote Command	:CALCulate:MONitor:MARKer[1] 2 3 4 5 6 7 8 9 10 11 12:MAXimum
Example	CALC:MON:MARK2:MAX
Initial S/W Revision	Prior to A.02.00

Recall

See [“Recall” on page 194](#) for more information.

Key Path	Front-panel key
----------	-----------------

Restart

See “Restart” on page 1558 for more information.

Key Path	Front-panel key
----------	-----------------

Save

See [“Save” on page 207](#) for more information.

Key Path	Front-panel key
----------	-----------------

Single

See “[Single \(Single Measurement/Sweep\)](#)” on page 1563 for more information.

Key Path	Front-panel key
----------	-----------------

Source

See [“Source” on page 1564](#) for more information.

Key Path	Front-panel key
----------	-----------------

Span X Scale

Accesses a menu of functions that enable you to set the horizontal scale parameters.

Key Path	Front-panel key
Initial S/W Revision	Prior to A.02.00

Span

Changes the frequency range symmetrically about the center frequency.

Key Path	Span X Scale
Mode	All except SA, BASIC
Remote Command	[:SENSE]:MONitor:FREQuency:SPAN <freq> [:SENSE]:MONitor:FREQuency:SPAN?
Example	MON:FREQ:SPAN 1 MHz MON:FREQ:SPAN?
Couplings	Changing the span causes the resolution bandwidth to change automatically, and affects data acquisition time.
Preset	WCDMA: 10.0 MHz WIMAX OFDMA: 50.0 MHz C2K: 2.5MHz PN: 1.0 MHz GSM/EDGE: 1.0 MHz TD-SCDMA: 3.2 MHz 1xEVDO: 2.0MHz DVB-T/H: 10.0MHz DTMB (CTTB): 10.0MHz ISDB-T: 10.0MHz CMMB: 10.0MHz LTE: 50 MHz LTETDD: 50 MHz IDEN: See the table below Digital Cable TV: 10.0MHz WLAN: 100.0 MHz MSR: 20.0 MHz

State Saved	Saved in instrument state.
Min	10 Hz
Max	Hardware Dependent: Option 503 = 3.7 GHz Option 507 = 7.1GHz Option 508 = 8.5 GHz Option 513 = 13.8 GHz Option 526 = 27.0 GHz
Initial S/W Revision	Prior to A.02.00
Modified at S/W Revision	A.02.00
Modified at S/W Revision	A.03.00

IDEN Mode Span Preset for Monitor Spectrum

iDEN Slot Format	WiDEN Slot Format 25kHz	WiDEN Slot Format 50kHz	WiDEN Slot Format 75kHz	WiDEN Slot Format 100kHz	WiDEN Slot Format 50kHz Out
60kHz	60kHz	85kHz	110kHz	135kHz	135kHz

Full Span

Changes the Span to show the full frequency range of the analyzer.

Key Path	Span X Scale
Mode	All except SA and BASIC
Remote Command	[:SENSE] :MONitor :FREQuency :SPAN :FULL
Example	MON:FREQ:SPAN:FULL
Couplings	Sets the span to the full frequency range, and adjusts the center frequency accordingly.
Initial S/W Revision	Prior to A.02.00

Last Span

Changes the measurement span to the span setting of the previous measurement. If there is no existing previous span value, then the span remains unchanged.

Key Path	Span X Scale
Mode	All except SA and BASIC

Monitor Spectrum Measurement
Span X Scale

Remote Command	[:SENSe] :MONitor:FREQuency:SPAN:PREVious
Example	MON:FREQ:SPAN:PREV
Couplings	Selecting last span changes the measurement span value.
Initial S/W Revision	Prior to A.02.00

Sweep/Control

Access a menu of functions that enable you to set up and control the sweep time for the current measurement

Key Path	Front-panel key
Initial S/W Revision	Prior to A.02.00

Sweep Time

Selects the length of time in which the spectrum analyzer sweeps the displayed frequency span. Additional overhead time is required by the analyzer. It impacts the sweep rate, but is not calculated as part of the sweep time. Reducing the sweep time increases the rate of sweeps.

Key Path	Sweep/Control
Mode	All except SA and BASIC
Remote Command	[:SENSe] :MONitor :SWEep :TIME <time> [:SENSe] :MONitor :SWEep :TIME? [:SENSe] :MONitor :SWEep :TIME :AUTO OFF ON 0 1 [:SENSe] :MONitor :SWEep :TIME :AUTO ?
Example	MON:SWE:TIME 100 ms MON:SWE:TIME? MON:SWE:TIME:AUTO ON MON:SWE:TIME:AUTO?
Preset	Automatically Calculated
State Saved	Saved in instrument state.
Min	1 ms
Max	4000 s
Initial S/W Revision	Prior to A.02.00
MIN/MAX/DEF Support	Yes

Pause

Pauses a measurement after the current data acquisition is complete. When Paused, the label on the key changes to Resume. Pressing Resume continues the measurement at the point where it had been paused.

Monitor Spectrum Measurement
Sweep/Control

See “Pause/Resume” on page 1577 under Sweep/Control for more information.

Key Path	Sweep/Control
Initial S/W Revision	Prior to A.02.00

Gate

Accesses a menu that enables you to control the gating function .

The Gate functionality is used to view signals best viewed by qualifying them with other events.

See “Gate ” on page 1578 for more details.

Key Path	Sweep/Control
Initial S/W Revision	Prior to A.02.00

Points

Sets the number of points per sweep. The resolution of setting the sweep time depends on the number of points selected. If Preset is selected, the number of points per sweep defaults to 1001. The current value of points is displayed parenthetically, next to the sweep time in the lower right corner of the display.

Key Path	Sweep/Control
Mode	All except SA and BASIC
Remote Command	[:SENSe] :MONitor :SWEep :POINts <integer> [:SENSe] :MONitor :SWEep :POINts?
Example	:MON:SWE:POIN 1000 :MON:SWE:POIN?
Couplings	Whenever the number of sweep points changes, the sweep time is re-quantized.
Preset	1001
State Saved	Saved in instrument state.
Range	1 to 20001
Initial S/W Revision	Prior to A.02.00

Trace/Detector

Accesses a menu that enables you to control the display, storage, detection and manipulation of trace data. Each trace is comprised of a series of data points in which X and Y axis information is stored. The analyzer updates the information for the active trace with each sweep of the current measurement.

Key Path	Front-panel key
Initial S/W Revision	Prior to A.02.00

Select Trace

Allows you to select which trace you want to use for the current measurement. You can select one of three traces. Monitor Spectrum supports 3 traces, numbered 1 through 3.

Key Path	Trace/Detector
Mode	All except SA and BASIC
Preset	Trace 1
State Saved	The number of the selected trace is saved in Instrument State
Initial S/W Revision	Prior to A.02.00

Trace Type

Allows you to select the type of trace you want to you use for the current measurement. You can assign a trace type to one of the three available traces.

The first page of this menu contains a 1-of-N selection of the trace type (**Clear Write, Average, Max Hold, Min Hold**) for the selected trace.

Key Path	Trace/Detector
Mode	All except SA and BASIC
Remote Command	:TRACe[1] 2 3:MONitor:TYPE WRITe AVERAge MAXHold MINHold :TRACe[1] 2 3:MONitor:TYPE?
Example	TRAC:MON:TYPE WRIT TRAC:MON:TYPE?
Notes	WRITe = Clear Write AVERAge = Average MAXHold = Maximum Hold MINHold = Minimum Hold

Preset	WRITE
State Saved	Saved in instrument state.
Range	WRITE AVERage MAXHold MINHold for traces 1 through 3
Backwards Compatibility SCPI	:DISPlay:MONitor:VIEW:WINDow:TRACe[1] 2 3:TYPE
Initial S/W Revision	Prior to A.02.00

Update

Toggles a trace state between Update and Off. The Off selection makes the trace inactive (or a stored trace). This does not affect whether the trace is visible or not. Use the Display Show/Blank function to change the trace visibility.

Key Path	Trace/Detector
Mode	All except SA and BASIC
Remote Command	:TRACe[1] 2 3:MONitor:UPDate[:STATE] ON OFF 0 1 :TRACe[1] 2 3:MONitor:UPDate[:STATE]?
Example	TRAC3:MON:UPD OFF TRAC3:MON:UPD?
Preset	ON
State Saved	Saved in instrument state.
Range	On Off (View)
Initial S/W Revision	Prior to A.02.00

Display

Controls the visibility of a trace. In **Blank**, traces do not display nor appear on printouts but are otherwise unaffected. They may be queried and markers may be placed on them

Key Path	Trace/Detector
Mode	All except SA and BASIC
Remote Command	:TRACe[1] 2 3:MONitor:DISPlay[:STATE] ON OFF 0 1 :TRACe[1] 2 3:MONitor:DISPlay[:STATE]?
Example	TRAC:MON:DISP ON TRAC:MON:DISP?
Preset	ON OFF OFF
State Saved	Saved in instrument state.
Range	Show Blank

Initial S/W Revision	Prior to A.02.00
----------------------	------------------

Detector

Accesses a menu of functions that enable you to control the detectors for the current measurement. The following choices are available:

Auto — the detector selected depends on marker functions, trace functions, average type, and the trace averaging function.

- Normal — the detector determines the peak of the CW-like signals, and it yields alternating maximums and minimums of noise-like signals. This is also referred to as Rosenfell detection.
- Average — the detector determines the average of the signal within the sweep points. The averaging method depends upon the Average Type selection (voltage, power or log scales).
- Peak — the detector determines the maximum of the signal within the sweep points.
- Sample — the detector indicates the instantaneous level of the signal at the center of the sweep points represented by each display point.
- Negative Peak — the detector determines the minimum of the signal within the sweep points.

In swept analysis, the time interval of the data collection for the display sweep points also represents a frequency interval. In FFT analysis, the sweep points represent just a frequency interval. The detector determines the relationship between the spectrum computed by the FFT and the single data point displayed for the sweep points.

Key Path	Trace/Detector
Mode	All except SA and BASIC
Remote Command	[:SENSE] :MONitor:DETEctor:TRACe AVERage NEGAtive NORMAl POSitive SAMPlE [:SENSE] :MONitor:DETEctor:TRACe?
Example	MON:DET:TRAC NORM MON:DET:TRAC?
Notes	The query returns a name that corresponds to the detector type as shown below. String Returned - Definition <ul style="list-style-type: none"> • NORM - Normal • AVER - Average • POS - Peak • SAMP - Sample • NEG – Negative Peak
Couplings	When the Detector choice is Auto, the detector selected depends on average type.

Monitor Spectrum Measurement
Trace/Detector

Preset	NORMal
State Saved	Saved in instrument state.
Range	Normal Average(RMS) Peak Sample Negative Peak
Backwards Compatibility SCPI	[:SENSE]:MONitor:DETEctor[:FUNCTion]
Initial S/W Revision	Prior to A.02.00

Auto

Sets the detector for the currently selected trace to Auto. When the detector choice is Auto, the analyzer selects the detector. The selected detector depends on marker functions, trace functions, and trace averaging functions for the current measurement.

Key Path	Trace/Detector Trace/Detector, Detector
Mode	All except SA and BASIC
Remote Command	[:SENSE]:MONitor:DETEctor:AUTO ON OFF 1 0 [:SENSE]:MONitor:DETEctor:AUTO?
Example	MON:DET:AUTO OFF MON:DET:AUTO?
Couplings	When the Detector choice is Auto, the detector selected depends on average state and trace type.
Preset	ON
State Saved	Saved in instrument state.
Range	Auto Man
Initial S/W Revision	Prior to A.02.00

Clear Trace

Clears the selected trace from the display.

Key Path	Trace/Detector
Mode	All except SA and BASIC
Remote Command	:TRACe:MONitor:CLEar [TRACE1] TRACE2 TRACE3
Example	TRAC:MON:CLE
Initial S/W Revision	Prior to A.02.00

Mode	All except SA and BASIC
------	-------------------------

Remote Command	:DISPlay:MONitor:VIEW:WINDow:TRACe[1] 2 3:CLEar
Example	DISP:MON:VIEW:WIND:TRAC:CLE
Initial S/W Revision	Prior to A.02.00

Clear All Traces

Clears all traces from the display.

Key Path	Trace/Detector
Mode	All except SA and BASIC
Remote Command	:TRACe:MONitor:CLEar:ALL
Example	TRAC:MON:CLE:ALL
Backwards Compatibility SCPI	:DISPlay:MONitor:VIEW:WINDow:TRACe:CLEar:ALL
Initial S/W Revision	Prior to A.02.00

Trigger

Accesses a menu of functions that enable you to select and control the trigger source for the current measurement.

See [“Trigger” on page 1595](#) for more information.

Key Path	Front-panel key
----------	-----------------

View/Display

Accesses a menu of functions that enable you to control certain functions related to the display of the analyzer.

If current mode is NOT MSR, there is a single trace view for this measurement.

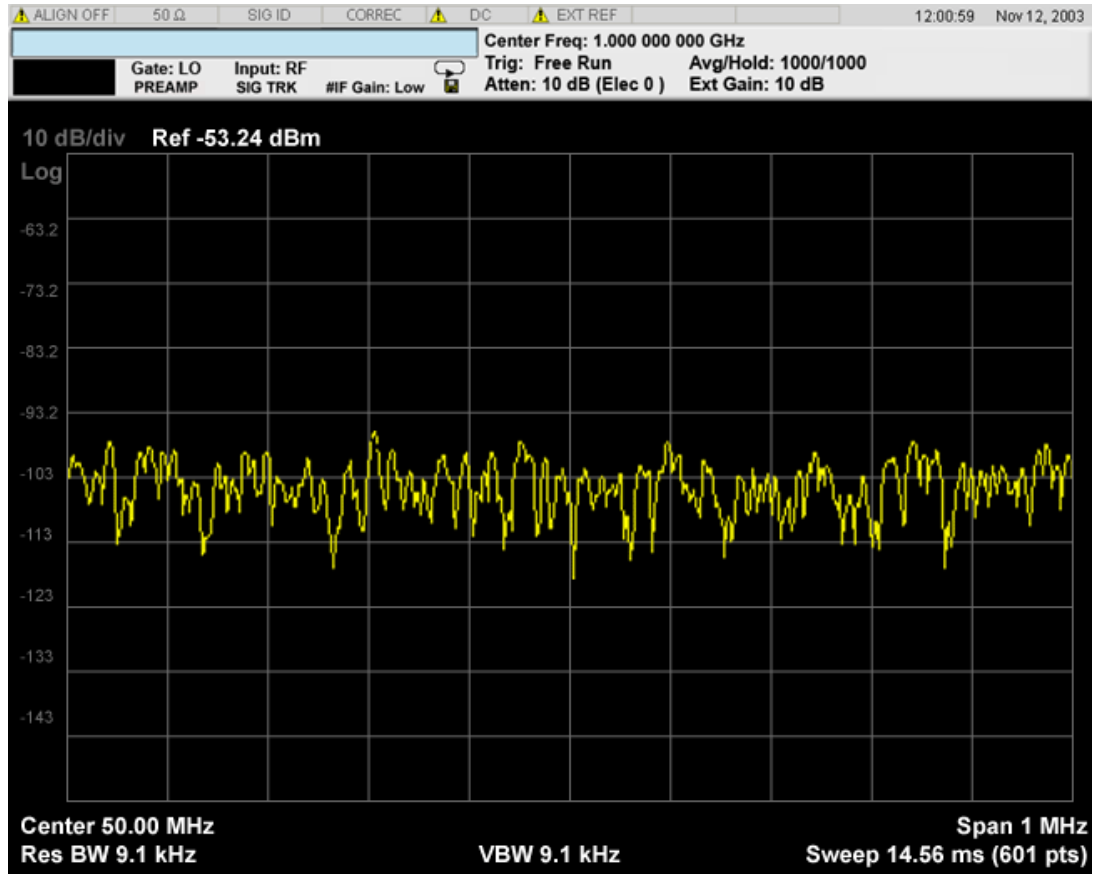

When the mode is CDMA1xEVDO, the view will be like

Monitor Spectrum Measurement
View/Display

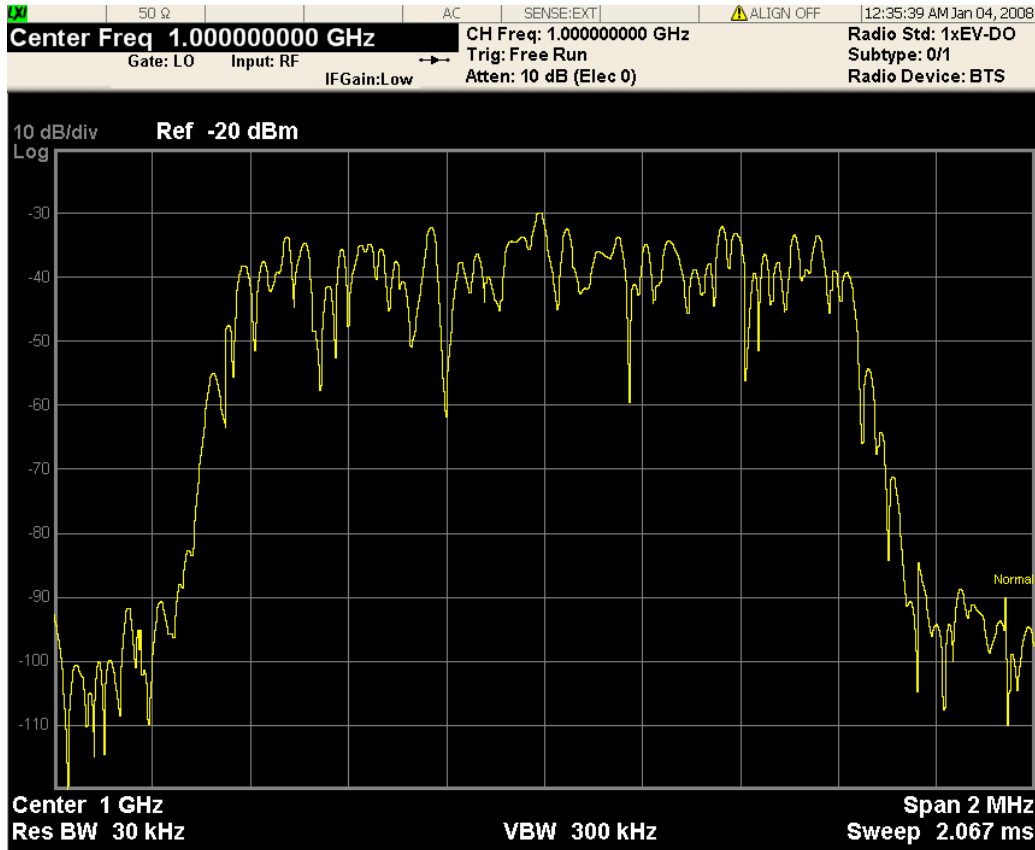

The measurement has no results, but has a number of features that make it flexible and simple to use.

If current mode is MSR, there are two views, Result Trace and Carrier Info. Result Trace view is the same as the common Monitor Spectrum view. Carrier Info is available on the spectrum trace.

Result Trace:

This is the original view supported by the common meas. The spectrum trace and power bars are displayed in the upper window. Carrier and offset powers are summarized in the lower window.

Carrier Info:

Carrier center frequency can be displayed in either offset or absolute frequency depending on Carrier Freq. The table can be scrolled by Select Carrier on Config Carriers menu. The highlighted row changes as Select Carrier is changed. The highlighted row and Select Carrier are not coupled.

View Selection by Name (MSR Only)

Key Path	Display
Mode	MSR
Remote Command	:DISPlay:MONitor:VIEW[:SElect] RTRace CINformation :DISPlay:MONitor:VIEW[:SElect]?
Example	DISP:MON:VIEW RTR DISP:MON:VIEW?

Preset	RTRace
State Saved	Saved in instrument state
Range	Power Results Carrier Info
Initial S/W Revision	A.10.00

Key Path	DISP:MON:VIEW
Mode	MSR
Remote Command	:DISPlay:MONitor:VIEW:NSElect <integer> :DISPlay:MONitor:VIEW:NSElect?
Example	DISP:MON:VIEW:NSEL 1 DISP:MON:VIEW:NSEL?
Preset	1
State Saved	Saved in instrument state
Min	1
Max	2
Initial S/W Revision	A.10.00

Key Path	Front-panel key
Initial S/W Revision	Prior to A.02.00

Display

Accesses a menu of functions that enable you to set the display parameters.

See “[Display](#)” on page 1646 for more information.

Key Path	View/Display
Initial S/W Revision	Prior to A.02.00

Result Trace (Only for MSR)

This is the original view supported by the common meas. The spectrum trace and power bars are displayed in the upper window. Carrier and offset powers are summarized in the lower window.

Monitor Spectrum Measurement
View/Display

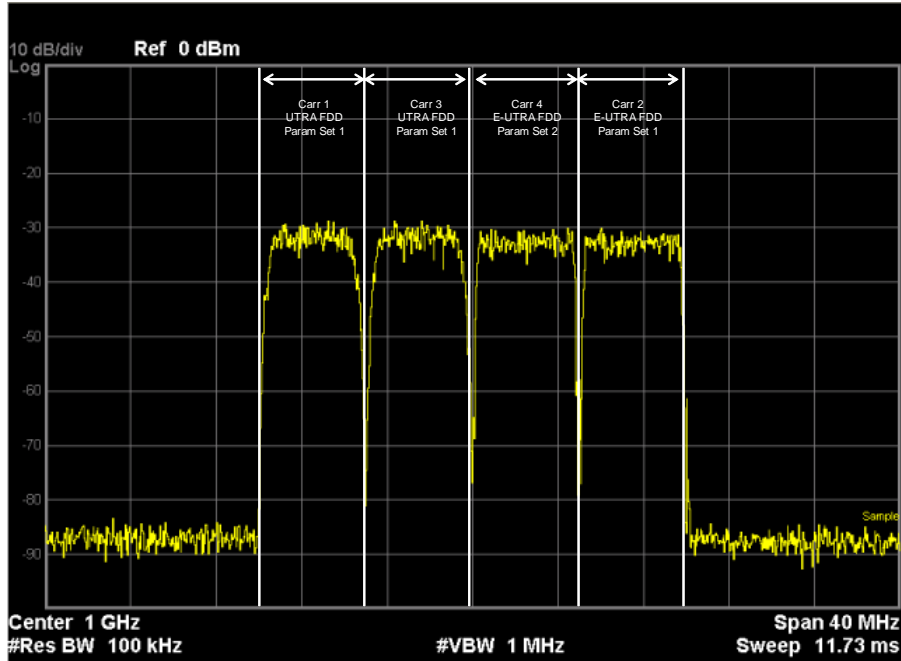

Key Path	View/Display
Initial S/W Revision	A.10.00

Carrier Info (Only for MSR)

Carrier center frequency can be displayed in either offset or absolute frequency depending on Carrier Freq. The table can be scrolled by Select Carrier on Config Carriers menu. The highlighted row changes as Select Carrier is changed. The highlighted row and Select Carrier are not coupled.

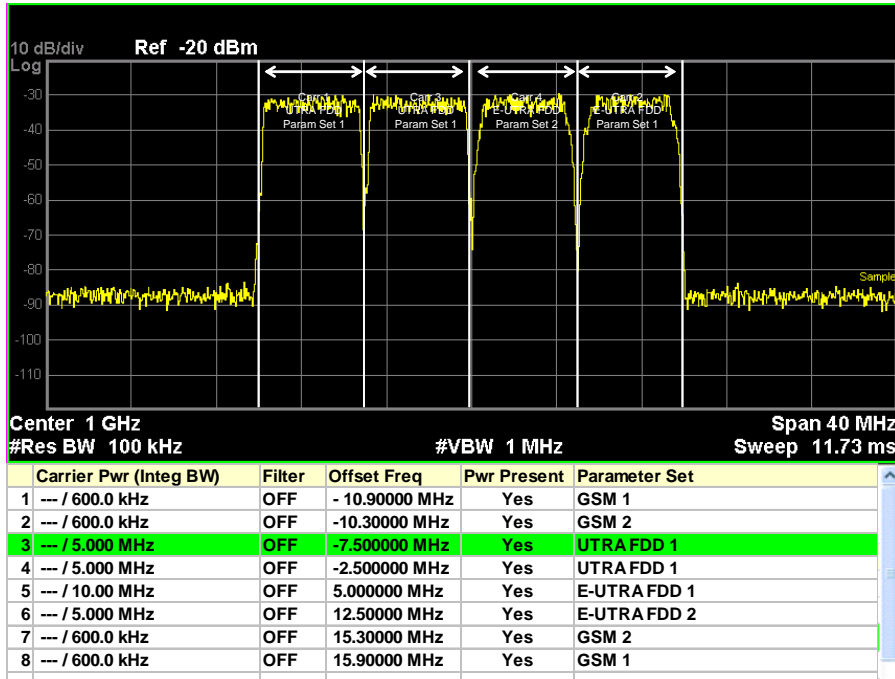

Key Path	View/Display
Initial S/W Revision	A.10.00

Carrier Freq (Only for MSR)

Selects frequency display type from Offset and Absolute. When Offset, carrier frequencies in the carrier table shown as offsets from Carrier Ref Freq. When Absolute, absolute frequencies are displayed.

Key Path	View/Display, Carrier Info
Mode	MSR
Remote Command	:DISPlay:MONitor:VIEW:WINDow:CINformation:FREquency OFFSet ABSolute :DISPlay:MONitor:VIEW:WINDow:CINformation:FREquency?
Example	DISP:MON:VIEW:WIND:CINF:FREQ ABS DISP:MON:VIEW:WIND:CINF:FREQ?
Notes	You must be in the MSR mode to use this command. Use :INSTrument:SElect to set the mode.
Preset	OFFSet
State Saved	Saved in instrument state
Range	Offset Absolute
Initial S/W Revision	A.10.00

Carrier Attribute (Only for MSR)

Toggle whether carrier information on the spectrum trace or not.

Carrier attributes are displayed as shown below left. There aren't enough space for displaying these texts when Span becomes larger. In this case, only vertical lines and arrows are displayed and the attribute texts are not. The attribute texts are allowed to be overlapped as shown below right.

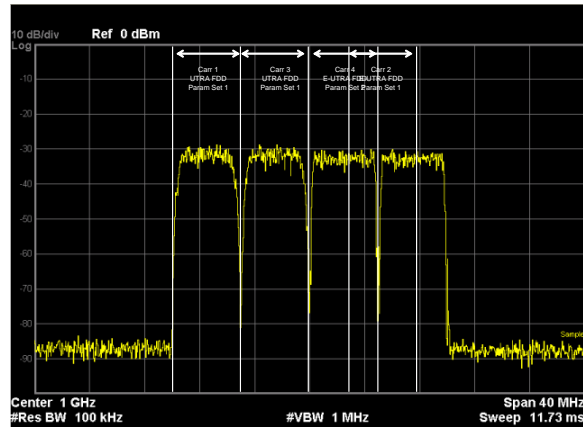
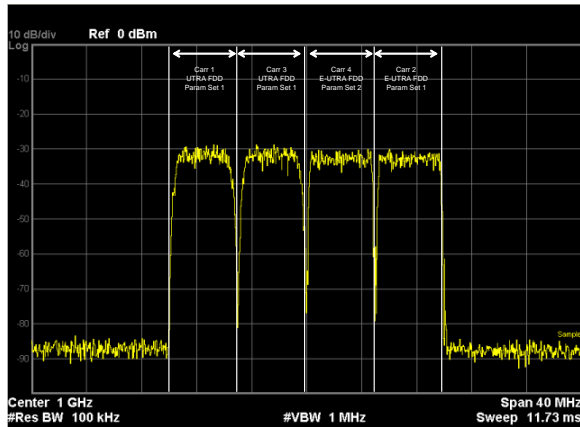

Key Path	View/Display
Mode	MSR
Remote Command	:DISPlay:MONitor:VIEW:WINDow:CATtribute OFF ON 0 1 :DISPlay:MONitor:VIEW:WINDow:CATtribute?
Example	DISP:MON:VIEW:WIND:CATT 0 DISP:MON:VIEW:WIND:CATT?
Notes	You must be in MSR to use this command. Use :INSTrument:SELEct to set the mode.
Preset	ON
State Saved	Saved in instrument state.
Range	On Off
Initial S/W Revision	A.10.00

The waveform measurement is a generic measurement for viewing the input signal waveforms in the time domain. This measurement represents how the instrument performs the zero span functionality found in traditional spectrum analyzers. For more details, see [“Waveform Measurement Description” on page 1270](#) below.

For information on how to make measurement using the X-Series Signal Analyzer, see:

Measurement Guide [n9080-90006.pdf].

This topic contains the following sections:

[“Measurement Commands for Waveform” on page 1269](#)

[“Remote Command Results for the Waveform Measurement” on page 1269](#)

Measurement Commands for Waveform

The general functionality of CONFigure, INITiate, FETCh, MEASure, and READ are described at this section.

:CONFigure:WAVEform

:CONFigure:WAVEform:NDEFault

:INITiate:WAVEform

:FETCh:WAVEform[n]

:MEASure:WAVEform[n]

:READ:WAVEform[n]

For more measurement related commands, see the SENSE subsystem, and the section [“Remote Measurement Functions” on page 1520](#).

Remote Command Results for the Waveform Measurement

The following table denotes the returned results from the FETCh|MEASure|READ commands:

n	Results Returned
0	Returns unprocessed I/Q trace data, as a series of trace point values, in volts. The I values are listed first in each pair, using the 0 through even-indexed values. The Q values are the odd-indexed values.

n	Results Returned
1	<p>Returns the following scalar results:</p> <ol style="list-style-type: none"> 1. Sample Time is a floating point number representing the time between samples when using the trace queries (n=0, 2, and so forth). 2. Mean Power is the mean power (in dBm). This is the power across the entire trace. If averaging is on, the power is for the latest acquisition. 3. Mean Power Averaged is the power (in dBm) for N averages, if averaging is on. This is the power across the entire trace. If averaging is on, the power is for the latest acquisition. If averaging is off, the value of the mean power averaged is the same as the value of the mean power. 4. Number of samples is the number of data points in the captured signal. This number is useful when performing a query on the signal (i.e. when n=0, 2, etc.). 5. Peak-to-mean ratio has units of dB. This is the ratio of the maximum signal level to the mean power. Valid values are only obtained with averaging turned off. If averaging is on, the peak-to-mean ratio is calculated using the highest peak value, rather than the displayed average peak value. 6. Maximum value is the maximum of the most recently acquired data (in dBm). 7. Minimum value is the minimum of the most recently acquired data (in dBm).
2	<p>Returns trace point values of the entire captured signal envelope trace data. These data points are floating point numbers representing the power of the signal (in dBm). There are N data points, where N is the number of samples. The period between the samples is defined by the sample time.</p>

Waveform Measurement Description

Also available under the basic Waveform measurement is an I/Q window, which shows the I and Q signal waveforms in parameters of voltage versus time to disclose the voltages that comprise the complex modulated waveform of a digital signal.

The waveform measurement can also be used to perform general purpose power measurements to a high degree of accuracy.

Key Path	Front-panel key
Initial S/W Revision	Prior to A.02.00

AMPTD Y Scale

Accesses a menu of functions that enable you to set the vertical scale parameters.

Key Path	Front-panel key
Initial S/W Revision	Prior to A.02.00

Ref Value

Sets the absolute power reference value. However, since Auto Scaling is defaulted to On, this value is automatically determined by the measurement result. When you set a value manually, Auto Scaling automatically changes to Off.

Ref Value (RF Envelope View)

Sets the Y Scale reference value (in dBm) when the RF Envelope View is active. By default, the measurement determines the reference value with Auto Scaling. Entering a reference value manually turns Auto Scaling off.

Key Path	AMPTD Y Scale
Mode	BASIC, PN, WCDMA, C2K, GSM, WIMAX OFDMA, TD-SCDMA, 1xEV-DO, DVB-T/H, DTMB (CTTB), ISDB-T, CMMB, LTE, LTETDD, Digital Cable TV, WLAN
Remote Command	:DISPlay:WAVEform:VIEW[1]:WINDow[1]:TRACe:Y[:SCALE]:RLEVel <ampl> :DISPlay:WAVEform:VIEW[1]:WINDow[1]:TRACe:Y[:SCALE]:RLEVel?
Example	DISP:WAV:VIEW:WIND:TRAC:Y:RLEV -50 dBm DISP:WAV:VIEW:WIND:TRAC:Y:RLEV?
Notes	You must be in the mode that includes Waveform measurement to use this command. Use INSTRument:SElect to set the mode.
Couplings	When Auto Scaling is On, this value is automatically determined by the measurement result. When you set a value manually, Auto Scaling automatically changes to Off.
Preset	10.00 dBm
State Saved	Saved in instrument state.
Range	-250.00 dBm to 250.00 dBm
Initial S/W Revision	Prior to A.02.00
Modified at S/W Revision	A.03.00

Ref Value (I/Q Waveform View)

Sets the Y Scale reference value (in volts) when the I/Q Waveform View is active. By default, the measurement determines the reference value with Auto Scaling. Entering a reference value manually turns Auto Scaling off.

Key Path	AMPTD Y Scale
Mode	BASIC, PN, WCDMA, C2K, GSM, WIMAX OFDMA, TD-SCDMA, 1xEV-DO, DVB-T/H, DTMB (CTTB), ISDB-T, CMMB, LTE, LTETDD, WLAN
Remote Command	:DISP:WAVEform:VIEW2:WINDow[1]:TRACe:Y[:SCALe]:RLEVe1 <voltage> :DISP:WAVEform:VIEW2:WINDow[1]:TRACe:Y[:SCALe]:RLEVe1?
Example	DISP:WAV:VIEW2:WIND:TRAC:Y:RLEV 25 V DISP:WAV:VIEW2:WIND:TRAC:Y:RLEV?
Notes	You must be in a mode that includes the Waveform measurement to use this command. Use INSTRument:SElect to set the mode.
Couplings	When Auto Scaling is On, this value is automatically determined by the measurement result. When you set a value manually, Auto Scaling automatically changes to Off.
Preset	0 V
State Saved	Saved in instrument state.
Min	-250 V
Max	250 V
Initial S/W Revision	Prior to A.02.00
Modified at S/W Revision	A.03.00

Attenuation

Accesses a menu of functions that enable you to change the attenuation settings. This key has a readback text that describes total attenuator value

This is only available when the selected input is RF.

For more information on this key, see [“Attenuation” on page 1381](#) .

Key Path	AMPTD Y Scale
Initial S/W Revision	Prior to A.02.00

Range

Accesses a menu that enables you to change the baseband I/Q gain settings. This key has a readback text that describes gain range value. For more information, refer to [“AMPTD Y Scale” on page 1379](#).

Key Path	AMPTD Y Scale
Initial S/W Revision	Prior to A.02.00

Scale/Div

Sets the units per division of vertical scale in the logarithmic display. However, since Auto Scaling is defaulted to On, this value is automatically determined by the measurement result. When you set a value manually, Auto Scaling automatically changes to Off.

Scale/Div (RF Envelope View)

Sets the scale per division for the RF Envelope result waveform (time domain) measurements in the graph window.

Key Path	AMPTD Y Scale
Mode	BASIC, PN, WCDMA, C2K, GSM, WIMAX OFDMA, TD-SCDMA, 1xEV-DO, DVB-T/H, DTMB (CTTB), ISDB-T, CMMB, LTE, LTETDD, Digital Cable TV, WLAN
Remote Command	:DISPlay:WAVEform:VIEW[1]:WINDow[1]:TRACe:Y[:SCALE]:PDI Vision <rel_ampl> :DISPlay:WAVEform:VIEW[1]:WINDow[1]:TRACe:Y[:SCALE]:PDI Vision?
Example	DISP:WAV:VIEW:WIND:TRAC:Y:PDIV 5 DISP:WAV:VIEW:WIND:TRAC:Y:PDIV?
Notes	You must be in a mode that includes the Waveform measurement to use this command. Use INSTRument:SElect to set the mode.
Couplings	When Auto Scaling is On, this value is automatically determined by the measurement result. When you set a value manually, Auto Scaling automatically changes to Off.
Preset	10.00 dB
State Saved	Saved in instrument state.
Range	0.10 dB to 20.00 dB
Initial S/W Revision	Prior to A.02.00
Modified at S/W Revision	A.03.00

Scale/Div (I/Q Waveform View)

Sets the scale per division for the I/Q signal waveform graph.

Key Path	AMPTD Y Scale
Mode	BASIC, PN, WCDMA, C2K, GSM, WIMAX OFDMA, TD-SCDMA, 1xEV-DO, DVB-T/H, DTMB (CTTB), ISDB-T, CMMB, LTE, LTETDD, Digital Cable TV, WLAN
Remote Command	:DISPlay:WAVEform:VIEW2:WINDow[1]:TRACe:Y[:SCALE]:PDIVi sion <voltage> :DISPlay:WAVEform:VIEW2:WINDow[1]:TRACe:Y[:SCALE]:PDIVi sion?
Example	DISP:WAV:VIEW2:WIND:TRAC:Y:PDIV 25mV DISP:WAV:VIEW2:WIND:TRAC:Y:PDIV?
Notes	You must be in a mode that includes the Waveform measurement to use this command. Use INSTRument:SElect to set the mode.
Couplings	When Auto Scaling is On, this value is automatically determined by the measurement result. When you set a value manually, Auto Scaling automatically changes to Off.
Preset	100.0 mV
State Saved	Saved in instrument state.
Min	1.0 nV
Max	20 V
Initial S/W Revision	Prior to A.02.00
Modified at S/W Revision	A.03.00

Presel Center

When this key is pressed, the centering of the preselector filter is adjusted to optimize the amplitude accuracy at the center frequency. This key does not appear in model numbers that do not contain an internal preselector (such as option 503 or all versions of the N9000A). Attempts to set via SCPI will be accepted without error. Queries will always return 0.

See “[Presel Center](#)” on page 1396 for more information.

This is only available when the selected input is RF.

Key Path	AMPTD Y Scale
Initial S/W Revision	Prior to A.02.00

Presel Adjust

Allows you to manually adjust the preselector filter frequency to optimize its response to the signal of interest. This function is only available when Presel Center is available.

This key does not appear in model numbers which do not contain an internal preselector (such as option 503 or all versions of the N9000A). Attempts to set via SCPI will be accepted without error. Queries will always return 0.

See [“Preselector Adjust” on page 1398](#) for more information.

This key is only available when the selected input is RF.

Key Path	AMPTD Y Scale
Initial S/W Revision	Prior to A.02.00

Internal Preamp

Accesses keys that control the internal preamps. Turning on the preamp gives a better noise figure, but a reduced TOI to noise floor dynamic range. You can optimize this setting for your particular measurement. The Low Band selection needs to show "(3.0 GHz)" for all versions of N9000A and "(3.6 GHz)" for the other models.

For more information, see [“Internal Preamp” on page 1410](#).

This key is only available when the selected input is RF.

Key Path	AMPTD Y Scale
Initial S/W Revision	Prior to A.02.00

Ref Position

Positions the reference level at the top, center or bottom of the Y Scale display. Changing the reference position does not change the reference level value.

Ref Position (RF Envelope View)

Positions the reference level at the top, center or bottom of the Y Scale display. Changing the reference position does not change the reference level value.

Key Path	AMPTD Y Scale
Mode	BASIC, PN, WCDMA, C2K, GSM, WIMAX OFDMA, TD-SCDMA, 1xEV-DO, DVB-T/H, DTMB (CTTB), ISDB-T, CMMB, LTE, LTETDD, Digital Cable TV, WLAN

Waveform Measurement
AMPTD Y Scale

Remote Command	:DISPlay:WAVEform:VIEW[1]:WINDow[1]:TRACe:Y[:SCALe]:RPO Sition TOP CENTer BOTTom :DISPlay:WAVEform:VIEW[1]:WINDow[1]:TRACe:Y[:SCALe]:RPO Sition?
Example	DISP:WAV:VIEW:WIND:TRAC:Y:RPOS CENT DISP:WAV:VIEW:WIND:TRAC:Y:RPOS?
Notes	You must be in a mode that includes the Waveform measurement to use this command. Use INSTRument:SELEct to set the mode.
Preset	TOP
State Saved	Saved in instrument state.
Range	Top Ctr Bot
Initial S/W Revision	Prior to A.02.00
Modified at S/W Revision	A.03.00

Ref Position (I/Q Waveform View)

Positions the reference level at the top, center or bottom of the Y Scale display. Changing the reference position does not change the reference level value.

Key Path	AMPTD Y Scale
Mode	BASIC, PN, WCDMA, C2K, GSM, WIMAX OFDMA, TD-SCDMA, 1xEV-DO, DVB-T/H, DTMB (CTTB), ISDB-T, CMMB, LTE, LTETDD, Digital Cable TV, WLAN
Remote Command	:DISPlay:WAVEform:VIEW2:WINDow[1]:TRACe:Y[:SCALe]:RPOSi tion TOP CENTer BOTTom :DISPlay:WAVEform:VIEW2:WINDow[1]:TRACe:Y[:SCALe]:RPOSi tion?
Example	DISP:WAV:VIEW2:WIND:TRAC:Y:RPOS CENT DISP:WAV:VIEW2:WIND:TRAC:Y:RPOS?
Notes	You must be in a mode that includes the Waveform measurement to use this command. Use INSTRument:SELEct to set the mode.
Preset	CENT
State Saved	Saved in instrument state.
Range	Top Ctr Bot
Initial S/W Revision	Prior to A.02.00
Modified at S/W Revision	A.03.00

Auto Scaling

Toggles the Auto Scaling function between On and Off. When the **Restart** front-panel key is pressed, this function automatically determines the scale per division and reference values based on the measurement results.

Key Path	AMPTD Y Scale
Mode	BASIC, PN, WCDMA, C2K, GSM, WIMAX OFDMA, TD-SCDMA, 1xEV-DO, DVB-T/H, DTMB (CTTB), ISDB-T, CMMB, LTE, LTETDD, Digital Cable TV, WLAN
Remote Command	:DISPlay:WAVEform:VIEW[1] 2:WINDow[1]:TRACe:Y[:SCALE]:COUPle 0 1 OFF ON :DISPlay:WAVEform:VIEW[1] 2:WINDow[1]:TRACe:Y[:SCALE]:COUPle?
Example	DISP:WAV:VIEW:WIND:TRAC:Y:COUP OFF DISP:WAV:VIEW:WIND:TRAC:Y:COUP?
Notes	You must be in a mode that includes the Waveform measurement to use this command. Use INSTRument:SElect to set the mode.
Couplings	When Auto Scaling is On, upon pressing the Restart front-panel key, this function automatically switches the scale per division and reference values into the defaults. When you set a value to either Scale/Div or Ref Value manually, Auto Scaling automatically changes to Off.
Preset	OFF
State Saved	Saved in instrument state.
Range	On Off
Initial S/W Revision	Prior to A.02.00
Modified at S/W Revision	A.03.00

Auto Couple

For details on this key, see [“Auto Couple” on page 1412](#).

Key Path	Front-panel key
----------	------------------------

BW

Accesses a menu that enables you to control the information bandwidth functions of the instrument. You can also select the filter type for the measurement.

Key Path	Front-panel key
Initial S/W Revision	Prior to A.02.00

Digital IF BW

Enables you to set the Digital IF (formerly Info BW) bandwidth of the instrument.

Key Path	BW
Mode	BASIC, PN, WCDMA, C2K, GSM, WIMAX OFDMA, TD-SCDMA, 1xEV-DO, DVB-T/H, DTMB (CTTB), ISDB-T, CMMB, LTE, LTETDD, Digital Cable TV, WLAN, MSR
Remote Command	[:SENSe] :WAVeform :DIF :BANDwidth <freq> [:SENSe] :WAVeform :DIF :BANDwidth?
Example	WAV:DIF:BAND 1kHz WAV:DIF:BAND?
Notes	Max value depends on the IF Path Selection
Remote Command Notes	You must be in a mode that includes the Waveform measurements to use this command. Use INSTRument:SElect to set the mode.
Dependencies	For applications that have the IF Path Selection menu such as the BASIC mode, if IF Path Auto is OFF, the maximum value depends on which IF Path is currently selected. If 10 MHz, 25 MHz, 40 MHz, or 140 MHz paths are selected, the maximum value of this parameter will be 10, 25, 40, or 140 MHz, respectively. If IF Path Auto is ON, the maximum value will be the maximum Digital IF BW available in the instrument regardless of the current IF Path Selection. For example, if the instrument had the options B25, B40, and B1X installed, the maximum available Digital IF BW of the instrument is 140 MHz. Thus, if IF Path Auto is ON and IF Path Selection is 25 MHz, the maximum Digital IF BW is not limited to 25 MHz but is 140 MHz.

Waveform Measurement
BW

Preset	<p>All except the following list: 100 kHz</p> <p>GSM/EDGE: 510 kHz</p> <p>TDSCDMA: 1.3 MHz</p> <p>1xEVDO: 1.3 MHz</p> <p>DVB-T/H: 8.0 MHz</p> <p>DTMB (CTTB): 8.0 MHz</p> <p>ISDB-T: 6.0 MHz</p> <p>CMMB: 8.0 MHz</p> <p>Digital Cable TV: 8 MHz</p> <p>WLAN: Hardware Dependent</p> <p> No option = 10 MHz</p> <p> Option B25 = 25 MHz</p> <p> WB(40MHz or wider):</p> <p> if Radio Std is 802.11a/b/g/n(20MHz) = 25 MHz</p> <p> if Radio Std is 802.11n(40MHz) = 40 MHz</p>
State Saved	Saved in instrument state.
Min	10 Hz
Max	<p>Hardware Dependent:</p> <p>RF Input:</p> <p> No Option = 10 MHz</p> <p> Option B25 = 25 MHz</p> <p> Option B40 = 40 MHz</p> <p> Option B1X = 140 MHz</p> <p> Option B1Y = 160 MHz</p> <p>I/Q Input:</p> <p> No Option = 10 MHz per channel (20 MHz for I+jQ)</p> <p> Option B25 = 25 MHz per channel (50 MHz for I+jQ)</p> <p> Option S40 = 40 MHz per channel (80 MHz for I+jQ)</p>
Backwards Compatibility SCPI	<p>[:SENSe] :WAVeform :BANDwidth [:RESolution]</p> <p>[:SENSe] :WAVeform :BWIDTh [:RESolution]</p>
Initial S/W Revision	Prior to A.02.00
Modified at S/W Revision	A.03.00

Filter Type

Selects the type of bandwidth filter that is used.

Besides the Gaussian filter shape, a variety of other filter types are available with variable alpha settings for maximum control over the filter shape..

Key Path	BW
Mode	BASIC, PN, WCDMA, C2K, GSM, WIMAX OFDMA, TD-SCDMA, 1xEV-DO, DVB-T/H, DTMB (CTTB), ISDB-T, CMMB, LTE, LTETDD, Digital Cable TV, WLAN, MSR
Remote Command	[:SENSe] :WAVeform :DIF :FILTer :TYPE GAUSSian FLATtop [:SENSe] :WAVeform :DIF :FILTer :TYPE? (With DIF40 and/or WBDIF) [:SENSe] :WAVeform :DIF :FILTer :TYPE GAUSSian FLATtop SNYQuist RSNYquist RCOSine RRCosine [:SENSe] :WAVeform :DIF :FILTer :TYPE?
Example	WAV:DIF:FILT:TYPE GAUS WAV:DIF:FILT:TYPE?
Remote Command Notes	You must be in a mode that includes the Waveform measurements to use this command. Use INSTRument:SElect to set the mode.
Dependencies	Gaussian and Flattop are available in all DIF configurations. For the other filter types, the filters are only available with PXA or when Option B40 is installed.
Preset	BASIC with B40 or B1X: FLATtop All other apps: GAUSSian
State Saved	Saved in instrument state.
Range	Gaussian FlatTop (With Digital IF and/or Option B40 or B1X) Gaussian Flattop Short nyquist Root Short Nquist Raised Cosine Root RaisedCosine
Backwards Compatibility SCPI	[:SENSe] :WAVeform :BANDwidth :SHAPE [:SENSe] :WAVeform :BWIDth :SHAPE [:SENSe] :WAVeform :BANDwidth BWIDth [:RESolution] :TYPE
Initial S/W Revision	Prior to A.02.00
Modified at S/W Revision	A.03.00

Filter Type Bwcc

This parameter is strictly for Bwcc purposes.

Remote Command	[:SENSE] :WAVEform:WBIF:FILTer[:TYPE] GAUSSian NONE NYQuist RNYQuist RCOSine RRCosine [:SENSE] :WAVEform:WBIF:FILTer[:TYPE]?
Preset	BASIC with B40 or B1X : FLATtop All other apps: GAUSSian

Gaussian

With a PXA or Option B40, the capability for arbitrary Digital IF bandwidths is available. However, for instruments without the Digital IF or the Option B40 or B1X , the selectable Gaussian filter bandwidths are predetermined in the following list. There are 160 Info BWs (RBWs). They are arranged in a 24-per-decade sequence from 1 Hz through 3 MHz, plus the 4, 5, 6 and 8 MHz settings.

The table in the section [“Gaussian filters” on page 1283](#) lists all 160 Gaussian filter types.

Gaussian filters

Normal (-3 dB)	-6 dB	Noise	Impulse
1.0 Hz	1.41 Hz	1.06 Hz	1.49 Hz
1.1 Hz	1.55 Hz	1.16 Hz	1.63 Hz
1.2 Hz	1.69 Hz	1.27 Hz	1.77 Hz
1.3 Hz	1.83 Hz	1.37 Hz	1.92 Hz
1.5 Hz	2.11 Hz	1.59 Hz	2.22 Hz
1.6 Hz	2.25 Hz	1.69 Hz	2.37 Hz
1.8 Hz	2.53 Hz	1.90 Hz	2.66 Hz
2.0 Hz	2.81 Hz	2.12 Hz	2.96 Hz
2.2 Hz	3.09 Hz	2.33 Hz	3.25 Hz
2.4 Hz	3.38 Hz	2.54 Hz	3.55 Hz
2.7 Hz	3.80 Hz	2.86 Hz	3.99 Hz
3.0 Hz	4.22 Hz	3.17 Hz	4.44 Hz
3.3 Hz	4.64 Hz	3.49 Hz	4.88 Hz
3.6 Hz	5.06 Hz	3.81 Hz	5.32 Hz
3.9 Hz	5.49 Hz	4.12 Hz	5.77 Hz
4.3 Hz	6.05 Hz	4.55 Hz	6.36 Hz
4.7 Hz	6.61 Hz	4.97 Hz	6.95 Hz
5.1 Hz	7.17 Hz	5.39 Hz	7.54 Hz
5.6 Hz	7.87 Hz	5.92 Hz	8.27 Hz
6.2 Hz	8.72 Hz	6.56 Hz	9.17 Hz
6.8 Hz	9.55 Hz	7.18 Hz	10.0 Hz
7.5 Hz	10.5 Hz	7.93 Hz	11.1 Hz
8.2 Hz	11.5 Hz	8.66 Hz	12.1 Hz
9.1 Hz	12.8 Hz	9.64 Hz	13.5 Hz
10 Hz	14.0 Hz	10.6 Hz	14.8 Hz
11 Hz	15.4 Hz	11.6 Hz	16.2 Hz
12 Hz	16.9 Hz	12.7 Hz	17.7 Hz
13 Hz	18.3 Hz	13.7 Hz	19.2 Hz
15 Hz	21.1 Hz	15.9 Hz	22.2 Hz

Waveform Measurement

BW

Normal (-3 dB)	-6 dB	Noise	Impulse
16 Hz	22.5 Hz	16.9 Hz	23.7 Hz
18 Hz	25.3 Hz	19.1 Hz	26.6 Hz
20 Hz	28.1 Hz	21.1 Hz	29.5 Hz
22 Hz	30.9 Hz	23.2 Hz	32.5 Hz
24 Hz	33.8 Hz	25.4 Hz	35.5 Hz
27 Hz	38.0 Hz	28.6 Hz	40.0 Hz
30 Hz	42.3 Hz	31.8 Hz	44.5 Hz
33 Hz	46.3 Hz	34.8 Hz	48.7 Hz
36 Hz	50.7 Hz	38.1 Hz	53.3 Hz
39 Hz	54.9 Hz	41.3 Hz	57.7 Hz
43 Hz	60.5 Hz	45.5 Hz	63.6 Hz
47 Hz	66.1 Hz	49.7 Hz	69.5 Hz
51 Hz	71.7 Hz	53.9 Hz	75.3 Hz
56 Hz	78.9 Hz	59.3 Hz	83.0 Hz
62 Hz	87.3 Hz	65.6 Hz	91.7 Hz
68 Hz	95.5 Hz	71.8 Hz	100 Hz
75 Hz	106 Hz	79.4 Hz	111 Hz
82 Hz	115 Hz	86.8 Hz	121 Hz
91 Hz	128 Hz	96.4 Hz	135 Hz
100 Hz	141 Hz	106 Hz	148 Hz
110 Hz	154 Hz	116 Hz	162 Hz
120 Hz	169 Hz	127 Hz	178 Hz
130 Hz	183 Hz	137 Hz	192 Hz
150 Hz	211 Hz	159 Hz	222 Hz
160 Hz	225 Hz	169 Hz	237 Hz
180 Hz	253 Hz	190 Hz	266 Hz
200 Hz	281 Hz	211 Hz	295 Hz
220 Hz	309 Hz	232 Hz	325 Hz
240 Hz	337 Hz	254 Hz	355 Hz
270 Hz	380 Hz	286 Hz	400 Hz

Normal (-3 dB)	-6 dB	Noise	Impulse
300 Hz	422 Hz	317 Hz	444 Hz
330 Hz	463 Hz	348 Hz	487 Hz
360 Hz	507 Hz	381 Hz	533 Hz
390 Hz	550 Hz	413 Hz	578 Hz
430 Hz	605 Hz	455 Hz	636 Hz
470 Hz	662 Hz	498 Hz	696 Hz
510 Hz	718 Hz	540 Hz	755 Hz
560 Hz	789 Hz	593 Hz	829 Hz
620 Hz	872 Hz	655 Hz	916 Hz
680 Hz	958 Hz	720 Hz	1.01 kHz
750 Hz	1.06 kHz	794 Hz	1.11 kHz
820 Hz	1.15 kHz	866 Hz	1.21 kHz
910 Hz	1.28 kHz	964 Hz	1.35 kHz
1.0 kHz	1.41 kHz	1.06 kHz	1.48 kHz
1.1 kHz	1.55 kHz	1.17 kHz	1.63 kHz
1.2 kHz	1.69 kHz	1.27 kHz	1.78 kHz
1.3 kHz	1.83 kHz	1.38 kHz	1.93 kHz
1.5 kHz	2.11 kHz	1.59 kHz	2.22 kHz
1.6 kHz	2.26 kHz	1.70 kHz	2.37 kHz
1.8 kHz	2.54 kHz	1.91 kHz	2.67 kHz
2.0 kHz	2.82 kHz	2.12 kHz	2.96 kHz
2.2 kHz	3.10 kHz	2.33 kHz	3.26 kHz
2.4 kHz	3.38 kHz	2.54 kHz	3.56 kHz
2.7 kHz	3.80 kHz	2.86 kHz	4.00 kHz
3.0 kHz	4.23 kHz	3.18 kHz	4.44 kHz
3.3 kHz	4.65 kHz	3.49 kHz	4.89 kHz
3.6 kHz	5.06 kHz	3.81 kHz	5.32 kHz
3.9 kHz	5.48 kHz	4.12 kHz	5.76 kHz
4.3 kHz	6.07 kHz	4.56 kHz	6.38 kHz
4.7 kHz	6.62 kHz	4.98 kHz	6.96 kHz

Normal (-3 dB)	-6 dB	Noise	Impulse
5.1 kHz	7.16 kHz	5.38 kHz	7.53 kHz
5.6 kHz	7.87 kHz	5.92 kHz	8.27 kHz
6.2 kHz	8.74 kHz	6.57 kHz	9.18 kHz
6.8 kHz	9.58 kHz	7.20 kHz	10.1 kHz
7.5 kHz	10.5 kHz	7.92 kHz	11.1 kHz
8.2 kHz	11.5 kHz	8.66 kHz	12.1 kHz
9.1 kHz	12.8 kHz	9.64 kHz	13.5 kHz
10 kHz	14.1 kHz	10.6 kHz	14.8 kHz
11 kHz	15.4 kHz	11.6 kHz	16.2 kHz
12 kHz	16.9 kHz	12.7 kHz	17.8 kHz
13 kHz	18.3 kHz	13.7 kHz	19.2 kHz
15 kHz	21.2 kHz	15.9 kHz	22.3 kHz
16 kHz	22.4 kHz	16.8 kHz	23.5 kHz
18 kHz	25.2 kHz	19.0 kHz	26.5 kHz
20 kHz	28.4 kHz	21.3 kHz	29.8 kHz
22 kHz	31.2 kHz	23.4 kHz	32.8 kHz
24 kHz	33.8 kHz	25.4 kHz	35.6 kHz
27 kHz	38.1 kHz	28.7 kHz	40.1 kHz
30 kHz	42.1 kHz	31.7 kHz	44.3 kHz
33 kHz	46.8 kHz	35.2 kHz	49.2 kHz
36 kHz	50.1 kHz	37.7 kHz	52.7 kHz
39 kHz	54.8 kHz	41.2 kHz	57.6 kHz
43 kHz	61.1 kHz	46.0 kHz	64.3 kHz
47 kHz	66.2 kHz	49.8 kHz	69.6 kHz
51 kHz	72.3 kHz	54.3 kHz	76.0 kHz
56 kHz	79.5 kHz	59.8 kHz	83.6 kHz
62 kHz	86.3 kHz	64.9 kHz	90.8 kHz
68 kHz	96.5 kHz	72.6 kHz	101 kHz
75 kHz	106 kHz	79.7 kHz	111 kHz
82 kHz	114 kHz	86.0 kHz	120 kHz

Normal (-3 dB)	-6 dB	Noise	Impulse
91 kHz	129 kHz	97.3 kHz	136 kHz
100 kHz	140 kHz	105 kHz	147 kHz
110 kHz	154 kHz	116 kHz	162 kHz
120 kHz	169 kHz	127 kHz	178 kHz
130 kHz	182 kHz	137 kHz	192 kHz
150 kHz	210 kHz	158 kHz	221 kHz
160 kHz	223 kHz	168 kHz	235 kHz
180 kHz	253 kHz	190 kHz	266 kHz
200 kHz	280 kHz	211 kHz	295 kHz
220 kHz	308 kHz	232 kHz	324 kHz
240 kHz	336 kHz	253 kHz	353 kHz
270 kHz	380 kHz	286 kHz	400 kHz
300 kHz	420 kHz	316 kHz	441 kHz
330 kHz	467 kHz	352 kHz	491 kHz
360 kHz	506 kHz	380 kHz	532 kHz
390 kHz	550 kHz	414 kHz	578 kHz
430 kHz	599 kHz	451 kHz	629 kHz
470 kHz	660 kHz	497 kHz	693 kHz
510 kHz	715 kHz	538 kHz	750 kHz
560 kHz	786 kHz	592 kHz	826 kHz
620 kHz	867 kHz	653 kHz	912 kHz
680 kHz	952 kHz	717 kHz	1.00 MHz
750 kHz	1.05 MHz	791 kHz	1.10 MHz
820 kHz	1.14 MHz	859 kHz	1.19 MHz
910 kHz	1.27 MHz	960 kHz	1.34 MHz
1.0 MHz	1.40 MHz	1.06 MHz	1.47 MHz
1.1 MHz	1.53 MHz	1.15 MHz	1.61 MHz
1.2 MHz	1.66 MHz	1.26 MHz	1.75 MHz
1.3 MHz	1.80 MHz	1.36 MHz	1.89 MHz
1.5 MHz	2.06 MHz	1.56 MHz	2.17 MHz

Normal (-3 dB)	-6 dB	Noise	Impulse
1.6 MHz	2.19 MHz	1.66 MHz	2.29 MHz
1.8 MHz	2.51 MHz	1.91 MHz	2.63 MHz
2.0 MHz	2.75 MHz	2.10 MHz	2.88 MHz
2.2 MHz	3.00 MHz	2.30 MHz	3.14 MHz
2.4 MHz	3.30 MHz	2.54 MHz	3.45 MHz
2.7 MHz	3.63 MHz	2.81 MHz	3.78 MHz
3.0 MHz	4.09 MHz	3.18 MHz	4.22 MHz
4 MHz	5.30 MHz	4.23 MHz	5.30 MHz
5 MHz	5.78 MHz	4.81 MHz	5.41 MHz
6 MHz	6.31 MHz	5.50 MHz	5.82 MHz
8 MHz	8.07 MHz	7.21 MHz	6.90 MHz

Flattop

With a PXA or Option B40, the capability for arbitrary Digital IF bandwidths is available. However, for instruments without the Digital IF or the Option B40 or B1X, the selectable Flattop filter bandwidths are predefined in the following table. There are 134 Digital IF BWs (RBWs).

The table in the section “[Flattop Filters](#)” on page 1289 lists all 134 Flattop filter types.

Flattop Filters

3.0 Hz	3.3 Hz	3.6 Hz	3.9 Hz
4.3 Hz	4.7 Hz	5.1 Hz	5.6 Hz
6.2 Hz	6.8 Hz	7.5 Hz	8.2 Hz
9.1 Hz	10 Hz	11 Hz	12 Hz
13 Hz	15 Hz	16 Hz	18 Hz
20 Hz	22 Hz	24 Hz	27 Hz
30 Hz	33 Hz	36 Hz	39 Hz
43 Hz	47 Hz	51 Hz	56 Hz
62 Hz	68 Hz	75 Hz	82 Hz
91 Hz	100 Hz	110 Hz	120 Hz
130 Hz	150 Hz	160 Hz	180 Hz
200 Hz	220 Hz	240 Hz	270 Hz
300 Hz	330 Hz	360 Hz	390 Hz
430 Hz	470 Hz	510 Hz	560 Hz
620 Hz	680 Hz	750 Hz	820 Hz
910 Hz	1.0 kHz	1.1 kHz	1.2 kHz
1.3 kHz	1.5 kHz	1.6 kHz	1.8 kHz
2.0 kHz	2.2 kHz	2.4 kHz	2.7 kHz
3.0 kHz	3.3 kHz	3.6 kHz	3.9 kHz
4.3 kHz	4.7 kHz	5.1 kHz	5.6 kHz
6.2 kHz	6.8 kHz	7.5 kHz	8.2 kHz
9.1 kHz	10 kHz	11 kHz	12 kHz
13 kHz	15 kHz	16 kHz	18 kHz
20 kHz	22 kHz	24 kHz	27 kHz
30 kHz	33 kHz	36 kHz	39 kHz
43 kHz	47 kHz	51 kHz	56 kHz
62 kHz	68 kHz	75 kHz	82 kHz
91 kHz	100 kHz	110 kHz	120 kHz
130 kHz	150 kHz	160 kHz	180 kHz
200 kHz	220 kHz	240 kHz	270 kHz

300 kHz	330 kHz	390 kHz	430 kHz
510 kHz	620 kHz	750 kHz	1.0 MHz
1.5 MHz	3.0 MHz	4 MHz	5 MHz
6 MHz	8 MHz		

Filter BW

This feature is only available with PXA or when Option B40 is installed.

Key Path	BW
Mode	BASIC
Remote Command	[:SENSe]:WAVeform:DIF:FILTer:BANDwidth <freq> [:SENSe]:WAVeform:DIF:FILTer:BANDwidth? [:SENSe]:WAVeform:DIF:FILTer:BANDwidth:AUTO ON OFF 1 0 [:SENSe]:WAVeform:DIF:FILTer:BANDwidth:AUTO?
Example	WAV:DIF:FILT:BAND 1MHz WAV:DIF:FILT:BAND? WAV:DIF:FILT:BAND:AUTO 0 WAV:DIF:FILT:BAND:AUTO?
Notes	You must be in the IQ Analyzer (Basic) mode to use this command. Use INSTRument:SElect to set the mode.
Dependencies	This feature is only available with PXA or when Option B40 is installed.
Couplings	Sets the same value as the current Digital IF BW value upon a preset or when Channel Filter Bandwidth Auto is ON.
Preset	Same value as Digital IF BW ON
State Saved	Saved in instrument state.
Min	10 Hz
Max	Clipped to the current Digital IF BW value.
Initial S/W Revision	A.04.00

Channel Filter Bandwidth Bwcc (Remote Command Only)

This is the backward compatibility command for Channel Filter Bandwidth.

Mode	BASIC
------	-------

Remote Command	[:SENSE] :WAVEform:WBIF:FILTer:BANDwidth <real> [:SENSE] :WAVEform:WBIF:FILTer:BANDwidth?
Example	WAV:WBIF:FILT:BAND 0.3 WAV:WBIF:FILT:BAND?
Notes	You must be in the IQ Analyzer (Basic) mode to use this command. Use INSTRument:SElect to set the mode.
Dependencies	This feature is only available with PXA or when Option B40 is installed.
Couplings	The value is determined by the following equation. $\text{ChannelFilterBwBwcc} = \frac{\text{ChannelFilterBw}}{(\text{DigitalIFBw} * \text{OverSampleRatio})}$
Preset	0.8
State Saved	Saved in instrument state.
Min	0.01
Max	1.0
Initial S/W Revision	A.04.00

Filter Alpha

Sets the filter alpha for the DIF filter. This feature is only available with PXA or when Option B40 is installed.

Key Path	BW
Mode	BASIC
Remote Command	[:SENSE] :WAVEform:DIF:FILTer:ALPHa <real> [:SENSE] :WAVEform:DIF:FILTer:ALPHa?
Example	WAV:DIF:FILT:ALPH 0.5 WAV:DIF:FILT:ALPH?
Notes	You must be in the IQ Analyzer (Basic) mode to use this command. Use INSTRument:SElect to set the mode.
Dependencies	This feature is only available with PXA or when Option B40 is installed.
Preset	0.2
State Saved	Saved in instrument state.
Min	0.01
Max	1.00
Backwards Compatibility SCPI	[:SENSe] :WAVEform:WBIF:FILTer:ALPHa

Cont

For details on this key, see [“Cont \(Continuous Measurement/Sweep\)”](#) on page 1413.

Key Path	Front-panel key
----------	------------------------

FREQ Channel

For details on this key, see [“FREQ Channel”](#) on page 1414.

Key Path	Front-panel key
----------	-----------------

Input/Output

For details on this key, see [“Input/Output” on page 1422](#).

Key Path	Front-panel key
----------	------------------------

Marker

Accesses a menu that enables you to select, set up and control the markers for the current measurement.

Key Path	Front-panel key
Initial S/W Revision	Prior to A.02.00

Select Marker

Displays 12 markers available for selection.

Key Path	Marker
Initial S/W Revision	Prior to A.02.00

Marker Type

Sets the marker control mode to **Normal**, **Delta**, **Fixed** or **Off**. All interactions and dependencies detailed under the key description are enforced when the remote command is sent. If the selected marker is Off, pressing Marker sets it to Normal and places it at the center of the screen on the trace determined by the **Marker Trace** rules. At the same time, the Marker X Axis Value appears on the Active Function area.

The default active function is the active function for the currently selected marker control mode. If the current control mode is Off, there is no active function and the active function is turned off.

Key Path	Marker
Mode	BASIC, PN, WCDMA, C2K, GSM, WIMAX OFDMA, TD-SCDMA, 1xEV-DO, DVB-T/H, DTMB (CTTB), ISDB-T, CMMB, LTE, LTETDD, Digital Cable TV, WLAN
Remote Command	:CALCulate:WAVEform:MARKer[1] 2 3 4 5 6 7 8 9 10 11 12:MODE POSITION DELta OFF :CALCulate:WAVEform:MARKer[1] 2 3 4 5 6 7 8 9 10 11 12:MODE?
Example	CALC:WAV:MARK:MODE OFF CALC:WAV:MARK:MODE?

Notes	<p>If the selected marker is Off, pressing Marker sets it to Normal and places it at the center of the screen on the trace determined by the Marker Trace rules. At the same time, Marker X Axis Value appears on the Active Function area.</p> <p>Default Active Function: the active function for the selected marker's current control mode. If the current control mode is Off, there is no active function and the active function is turned off.</p> <p>Active Function Display: the marker X axis value entered in the active function area displays the marker value to its full entered precision.</p> <p>You must be in a mode that includes the Waveform measurement to use this command. Use INSTRument:SElect to set the mode.</p>
Preset	OFF
State Saved	Saved in instrument state.
Range	Normal Delta Off
Initial S/W Revision	Prior to A.02.00
Modified at S/W Revision	A.03.00

Marker X Axis Value (Remote Command Only)

Sets the marker X Axis value in the current marker X Axis Scale unit. It has no effect if the control mode is **Off**, but is the SCPI equivalent of entering an X value if the control mode is **Normal** or **Delta**.

Mode	BASIC, PN, WCDMA, C2K, GSM, WIMAX OFDMA, TD-SCDMA, 1xEV-DO, DVB-T/H, DTMB (CTTB), ISDB-T, CMMB, LTE, LTETDD, Digital Cable TV, WLAN
Remote Command	<pre>:CALCulate:WAVEform:MARKer[1] 2 3 4 5 6 7 8 9 10 11 12: X <time></pre> <pre>:CALCulate:WAVEform:MARKer[1] 2 3 4 5 6 7 8 9 10 11 12: X?</pre>
Example	<pre>CALC:WAV:MARK:X 50 ms</pre> <pre>CALC:WAV:MARK:X?</pre>
Notes	<p>If no suffix is sent, uses the fundamental units for the current marker X Axis Scale. If a suffix is sent that does not match the current marker X Axis Scale unit, an error "Invalid suffix" is generated. If the specified marker is Fixed and a Marker Function is on, error -221 "Settings conflict; cannot adjust Fixed marker while Marker Function is on" is generated.</p> <p>The query returns the marker's absolute X Axis value if the control mode is Normal, or the offset from the marker's reference marker if the control mode is Delta. The query is returned in the fundamental units for the current marker X Axis scale: Hz for Frequency and Inverse Time, seconds for Period and Time. If the marker is Off the response is not a number.</p> <p>You must be in a mode that includes the Waveform measurement to use this command. Use INSTRument:SElect to set the mode.</p>

Preset	0
Preset	After a preset, all markers are turned OFF, so Marker X Axis Value query returns a not a number (NAN).
State Saved	No
Min	-9.9E+37
Max	9.9E+37
Initial S/W Revision	Prior to A.02.00
Modified at S/W Revision	A.03.00

Marker X Axis Position (Remote Command Only)

Sets the marker X position in trace points. It has no effect if the control mode is **Off**, but is the SCPI equivalent of entering a value if the control mode is **Normal** or **Delta**. The entered value is immediately translated into the current X Axis Scale units for setting the value of the marker.

Mode	BASIC, PN, WCDMA, C2K, GSM, WIMAX OFDMA, TD-SCDMA, 1xEV-DO, DVB-T/H, DTMB (CTTB), ISDB-T, CMMB, LTE, LTETDD, Digital Cable TV, WLAN
Remote Command	:CALCulate:WAVEform:MARKer[1] 2 3 4 5 6 7 8 9 10 11 12: X:POSition <real> :CALCulate:WAVEform:MARKer[1] 2 3 4 5 6 7 8 9 10 11 12: X:POSition?
Example	CALC:WAV:MARK:X:POS 500 CALC:WAV:MARK:X:POS?
Notes	The query returns the marker's absolute X Axis value in trace points if the control mode is Normal or the offset from the marker's reference marker in trace points if the control mode is Delta . The value is returned as a real number, not an integer, corresponding to the translation from X Axis Scale units to trace points. You must be in a mode that includes the Waveform measurement to use this command. Use INSTRument:SElect to set the mode.
Preset	0
Preset	After a preset, all markers are turned OFF, so Marker X Axis Value query returns a not a number (NAN).
State Saved	No
Min	-9.9E+37
Max	9.9E+37
Initial S/W Revision	Prior to A.02.00
Modified at S/W Revision	A.03.00

Marker Y Axis Value (Remote Command Only)

Queries the marker Y Axis value in the current marker Y Axis unit.

Mode	BASIC, PN, WCDMA, C2K, GSM, WIMAX OFDMA, TD-SCDMA, 1xEV-DO, DVB-T/H, DTMB (CTTB), ISDB-T, CMMB, LTE, LTETDD, Digital Cable TV, WLAN
Remote Command	:CALCulate:WAVEform:MARKer[1] 2 3 4 5 6 7 8 9 10 11 12:Y?
Example	CALC:WAV:MARK11:Y?
Notes	<p>When the marker is on, IQ waveform returns I and Q values.</p> <p>Case #1 - Trace RF, I or Q: returns a single double value.</p> <pre>>:CALC:WAV:MARK1:Y? -2.402406506109E+001</pre> <p>Case #2 - Trace IQ: returns a double array of two values, the first is I, and the second is Q.</p> <pre>>:CALC:WAV:MARK1:Y? -3.006944493834E-003,+9.9870666467354E-004</pre> <p>The IQ selection is for backward compatibility purposes. It is recommended that the users use the I and/or Q selection instead.</p> <p>You must be in a mode that includes the Waveform measurement to use this command. Use INSTRument:SElect to set the mode.</p>
Preset	Result dependant on the marker setup and signal source.
State Saved	No
Backwards Compatibility SCPI	:CALCulate:WAVEform:MARKer[1] 2 3 4 5 6 7 8 9 10 11 12:FUNction:RESuIt?
Initial S/W Revision	Prior to A.02.00
Modified at S/W Revision	A.03.00

Properties

Accesses the marker properties menu.

Key Path	Marker
Initial S/W Revision	Prior to A.02.00

Select Marker

Displays 12 markers available for selection.

Key Path	Marker
----------	---------------

Initial S/W Revision	Prior to A.02.00
----------------------	------------------

Relative To

Selects the marker that the selected marker is relative to (its reference marker).

Key Path	Marker, Properties
Mode	BASIC, PN, WCDMA, C2K, GSM, WIMAX OFDMA, TD-SCDMA, 1xEV-DO, DVB-T/H, DTMB (CTTB), ISDB-T, CMMB, LTE, LTETDD, Digital Cable TV, WLAN
Remote Command	:CALCulate:WAVEform:MARKer[1] 2 3 4 5 6 7 8 9 10 11 12:REFerence <integer> :CALCulate:WAVEform:MARKer[1] 2 3 4 5 6 7 8 9 10 11 12:REFerence?
Example	CALC:WAV:MARK:REF 8 CALC:WAV:MARK:REF?
Notes	A marker cannot be relative to itself so that choice is grayed out, and if sent from SCPI generates error -221: "Settings conflict; marker cannot be relative to itself." When queried a single value is returned (the specified marker numbers relative marker). You must be in a mode that includes the Waveform measurement to use this command. Use INSTRument:SElect to set the mode.
Preset	2 3 4 5 6 7 8 9 10 11 12 1
State Saved	Saved in instrument state.
Min	1
Max	12
Initial S/W Revision	Prior to A.02.00
Modified at S/W Revision	A.03.00

Marker Trace

Assigns the specified marker to the designated trace.

Key Path	Marker
Mode	BASIC, PN, WCDMA, C2K, GSM, WIMAX OFDMA, TD-SCDMA, 1xEV-DO, DVB-T/H, DTMB (CTTB), ISDB-T, CMMB, LTE, LTETDD, Digital Cable TV, WLAN

Waveform Measurement
Marker

Remote Command	:CALCulate:WAVEform:MARKer[1] 2 3 4 5 6 7 8 9 10 11 12:TRACe RFENvelope I Q IQ :CALCulate:WAVEform:MARKer[1] 2 3 4 5 6 7 8 9 10 11 12:TRACe?
Example	CALC:WAV:MARK:TRAC RFEN CALC:WAV:MARK:TRAC?
Notes	Assigns the specified marker to the designated trace. The IQ selection is for backward compatibility purposes. It is recommended that the users use the I and/or Q selection instead. You must be in a mode that includes the Waveform measurement to use this command. Use INSTRument:SELEct to set the mode.
Preset	RFEN
State Saved	Saved in instrument state.
Range	RF Envelope I Q IQ
Initial S/W Revision	Prior to A.02.00
Modified at S/W Revision	A.03.00

Couple Markers

Toggles the state of the markers to be coupled On or Off. When this function is true (On), moving any marker causes an equal X-axis movement of every other marker which is not **Off**. “Equal X-axis movement” refers to the difference between each marker’s X-Axis value (in the fundamental x-axis units of the trace that marker is on) and the X-Axis value of the marker being moved (in the same fundamental x-axis units) are preserved.

Key Path	Marker
Mode	BASIC, PN, WCDMA, C2K, GSM, WIMAX OFDMA, TD-SCDMA, 1xEV-DO, DVB-T/H, DTMB (CTTB), ISDB-T, CMMB, LTE, LTETDD, Digital Cable TV, WLAN
Remote Command	:CALCulate:WAVEform:MARKer:COUPlE[:STATe] ON OFF 1 0 :CALCulate:WAVEform:MARKer:COUPlE[:STATe]?
Example	CALC:WAV:MARK:COUP ON CALC:WAV:MARK:COUP ON
Notes	You must be in a mode that includes the Waveform measurement to use this command. Use INSTRument:SELEct to set the mode.
Preset	OFF
State Saved	Saved in instrument state.
Range	On Off

Initial S/W Revision	Prior to A.02.00
Modified at S/W Revision	A.03.00

All Markers Off

Turns off all markers.

Key Path	Marker
Mode	BASIC, PN, WCDMA, C2K, GSM, WIMAX OFDMA, TD-SCDMA, 1xEV-DO, DVB-T/H, DTMB (CTTB), ISDB-T, CMMB, LTE, LTETDD, Digital Cable TV, WLAN
Remote Command	:CALCulate:WAVeform:MARKer:AOff
Example	CALC:WAV:MARK:AOff
Notes	You must be in a mode that includes the Waveform measurement to use this command. Use INSTRument:SElect to set the mode.
Initial S/W Revision	Prior to A.02.00
Modified at S/W Revision	A.03.00

Backward Compatibility SCPI Commands

Sets or queries the state of a marker. Setting a marker which is OFF to state ON or 1 puts it in Normal mode and places it at the center of the screen.

Mode	BASIC, PN, WCDMA, C2K, GSM, WIMAX OFDMA, TD-SCDMA, 1xEV-DO, DVB-T/H, DTMB (CTTB), ISDB-T, CMMB, LTE, LTETDD, Digital Cable TV, WLAN
Remote Command	:CALCulate:WAVeform:MARKer[1] 2 3 4 5 6 7 8 9 10 11 12:STATe OFF ON 0 1 :CALCulate:WAVeform:MARKer[1] 2 3 4 5 6 7 8 9 10 11 12:STATe?
Example	CALC:WAV:MARK:STAT ON CALC:WAV:MARK:STAT?
Notes	You must be in a mode that includes the Waveform measurement to use this command. Use INSTRument:SElect to set the mode.
Preset	OFF
State Saved	Saved in instrument state.
Range	On Off
Initial S/W Revision	Prior to A.02.00
Modified at S/W Revision	A.03.00

Marker Function

Accesses a menu of marker functions that perform post-processing operations on markers based on the measurement specifications. Marker functions are distinct from measurement functions, which automatically perform complex sequences of setup, data acquisition, and display operations in order to measure specified signal characteristics. Marker Functions are specified for each individual marker and may be turned on individually for each marker.

The **Marker Function** menu controls which marker functions are turned on and allows you to adjust the setup parameters for each function. These parameters include the following, but only one parameter can be assigned to a given marker:

- **Marker Noise**
- **Band/Interval Power**
- **Band/Interval Density**
- **Marker Function Off**

Key Path	Front-panel key
Initial S/W Revision	Prior to A.02.00

Select Marker

Displays 12 markers available for selection.

Key Path	Marker
Initial S/W Revision	Prior to A.02.00

Marker Function Type

Sets the marker control function type to, Marker Noise, Band/Interval Power, Band Interval Density, or Marker Function Off

Key Path	Marker Function
Mode	BASIC, PN, WCDMA, C2K, GSM, WIMAX OFDMA, TD-SCDMA, 1xEV-DO, DVB-T/H, DTMB (CTTB), ISDB-T, CMMB, LTE, LTETDD, Digital Cable TV, WLAN
Remote Command	:CALCulate:WAVeform:MARKer[1] 2 3 4 5 6 7 8 9 10 11 12:FUNCTION BPOW BDENSITY OFF :CALCulate:WAVeform:MARKer[1] 2 3 4 5 6 7 8 9 10 11 12:FUNCTION?
Example	CALC:WAV:MARK:FUNC BPOW CALC:WAV:MARK:FUNC?

Notes	You must be in a mode that includes the Waveform measurement to use this command. Use INSTRUMENT:SElect to set the mode.
Preset	OFF
State Saved	Saved in instrument state.
Range	Band/Interval Power Band Interval Density Marker Function Off
Initial S/W Revision	Prior to A.02.00
Modified at S/W Revision	A.03.00

Band Adjust

Accesses a menu that enables you to set the frequency span width and the left and right edge, or time values, for the band or interval of the selected marker.

Key Path	Marker Function
Initial S/W Revision	Prior to A.02.00

Band/Interval Span for Time Domain

Sets the width of the frequency span for the selected marker.

Key Path	Marker Function
Mode	BASIC, PN, WCDMA, C2K, GSM, WIMAX OFDMA, TD-SCDMA, 1xEV-DO, DVB-T/H, DTMB (CTTB), ISDB-T, CMMB, LTE, LTETDD, Digital Cable TV, WLAN
Remote Command	:CALCulate:WAVEform:MARKer[1] 2 3 4 5 6 7 8 9 10 11 12:FUNCTION:BAND:SPAN <time> :CALCulate:WAVEform:MARKer[1] 2 3 4 5 6 7 8 9 10 11 12:FUNCTION:BAND:SPAN?
Example	CALC:WAV:MARK:FUNC:BAND:SPAN 20 ms CALC:WAV:MARK:FUNC:BAND:SPAN?
Notes	You must be in a mode that includes the Waveform measurement to use this command. Use INSTRUMENT:SElect to set the mode.
Couplings	Changing the Band/Interval Span necessarily changes the Band/Interval Left and Band/Interval Right values
Preset	0
Preset	10% of Meas Time
State Saved	Saved in instrument state.
Min	0
Max	100 s

Waveform Measurement
Marker Function

Backwards Compatibility SCPI	:CALCulate:WAVEform:MARKer[1] 2 3 4:X:SPAN
Initial S/W Revision	Prior to A.02.00
Modified at S/W Revision	A.03.00

Band/Interval Left for Time Domain

Sets the left edge frequency or time value for the band of the selected marker.

Key Path	Marker Function
Mode	BASIC, PN, WCDMA, C2K, GSM, WIMAX OFDMA, TD-SCDMA, 1xEV-DO, DVB-T/H, DTMB (CTTB), ISDB-T, CMMB, LTE, LTETDD, Digital Cable TV, WLAN
Remote Command	:CALCulate:WAVEform:MARKer[1] 2 3 4 5 6 7 8 9 10 11 12:FUNction:BAND:LEFT <time> :CALCulate:WAVEform:MARKer[1] 2 3 4 5 6 7 8 9 10 11 12:FUNction:BAND:LEFT?
Example	CALC:WAV:MARK12:FUNC:BAND:LEFT 1 s CALC:WAV:MARK12:FUNC:BAND:LEFT?
Notes	You must be in a mode that includes the Waveform measurement to use this command. Use INSTRument:SElect to set the mode.
Couplings	Changing the Band/Interval Left necessarily changes the Band/Interval Span and Band/Interval Right values
Preset	0
Preset	5% of Meas Time
State Saved	Saved in instrument state.
Min	0
Max	100 s
Initial S/W Revision	Prior to A.02.00
Modified at S/W Revision	A.03.00

Band/Interval Right for Time Domain

Sets the right edge frequency or time value for the band of the selected marker.

Key Path	Marker Function
Mode	BASIC, PN, WCDMA, C2K, GSM, WIMAX OFDMA, TD-SCDMA, 1xEV-DO, DVB-T/H, DTMB (CTTB), ISDB-T, CMMB, LTE, LTETDD, Digital Cable TV, WLAN

Remote Command	:CALCulate:WAVEform:MARKer[1] 2 3 4 5 6 7 8 9 10 11 12: FUNction:BAND:RIGHT <time> :CALCulate:WAVEform:MARKer[1] 2 3 4 5 6 7 8 9 10 11 12: FUNction:BAND:RIGHT?
Example	CALC:WAV:MARK12:FUNC:BAND:RIGH 1 s CALC:WAV:MARK12:FUNC:BAND:RIGH?
Notes	You must be in a mode that includes the Waveform measurement to use this command. Use INSTRument:SElect to set the mode.
Couplings	Changing the Band/Interval Left necessarily changes the Band/Interval Span and Band/Interval Right values
Preset	0
Preset	5% of Meas Time
State Saved	Saved in instrument state.
Min	0
Max	100 s
Initial S/W Revision	Prior to A.02.00
Modified at S/W Revision	A.03.00

Marker To

There is no 'Marker To' functionality supported in Waveform measurements. The front-panel key displays a blank menu when pressed.

Key Path	Front-panel key
Initial S/W Revision	Prior to A.02.00

Meas

For details on this key, see [“Meas” on page 1520](#).

Key Path	Front-panel key
----------	-----------------

Meas Setup

Displays the setup menu keys that enable you to control the parameters for the current measurement.

Key Path	Front-panel key
Initial S/W Revision	Prior to A.02.00

Average/Hold Num

Sets the number of sweeps (average counts) that are averaged. After the specified number of sweeps, the averaging mode (terminal control) setting determines the averaging action.

Key Path	Meas Setup
Mode	BASIC, PN, WCDMA, C2K, GSM, WIMAX OFDMA, TD-SCDMA, 1xEV-DO, DVB-T/H, DTMB (CTTB), ISDB-T, CMMB, LTE, LTETDD, Digital Cable TV, WLAN, MSR
Remote Command	[:SENSE] :WAVEform:AVErAge:COUNt <integer> [:SENSE] :WAVEform:AVErAge:COUNt? [:SENSE] :WAVEform:AVErAge[:STATe] OFF ON 0 1 [:SENSE] :WAVEform:AVErAge[:STATe]?
Example	WAV:AVER:COUN 1001 WAV:AVER:COUN? WAV:AVER ON WAV:AVER?
Notes	You must be in a mode that includes the Waveform measurement to use this command. Use INSTRument:SELEct to set the mode.
Preset	10 OFF
State Saved	Saved in instrument state.
Min	1
Max	20001
Initial S/W Revision	Prior to A.02.00
Modified at S/W Revision	A.03.00

Avg Mode

Enables you to set the averaging mode.

When set to Exponential (Exp) the measurement averaging continues using the specified number of averages to compute each averaged value. The average is displayed at the end of each sweep.

When set to Repeat, the measurement resets the average counter each time the specified number of averages is reached.

Key Path	Meas Setup
Mode	BASIC, PN, WCDMA, C2K, GSM, WIMAX OFDMA, TD-SCDMA, 1xEV-DO, DVB-T/H, DTMB (CTTB), ISDB-T, CMMB, LTE, LTETDD, Digital Cable TV, WLAN, MSR
Remote Command	[:SENSe] :WAVeform:AVERage:TCONtrol EXPOnential REPeat [:SENSe] :WAVeform:AVERage:TCONtrol?
Example	WAV:AVER:TCON REP WAV:AVER:TCON?
Notes	You must be in a mode that includes the Waveform measurement to use this command. Use INSTRument:SElect to set the mode.
Preset	EXPOnential
State Saved	Saved in instrument state.
Range	Exp Repeat
Initial S/W Revision	Prior to A.02.00
Modified at S/W Revision	A.03.00

Avg Type

Selects the type of averaging.

Key Path	Meas Setup
Mode	BASIC, PN, WCDMA, C2K, GSM, WIMAX OFDMA, TD-SCDMA, 1xEV-DO, DVB-T/H, DTMB (CTTB), ISDB-T, CMMB, LTE, LTETDD, Digital Cable TV, WLAN, MSR
Remote Command	[:SENSe] :WAVeform:AVERage:TYPE LOG MAXimum MINimum RMS SCALar [:SENSe] :WAVeform:AVERage:TYPE?
Example	WAV:AVER:TYPE MAX WAV:AVER:TYPE?
Notes	The SCPI selection of MAX and MIN are kept for BWCC, but they are removed from the front panel access because they are not an Average function. You must be in a mode that includes the Waveform measurement to use this command. Use INSTRument:SElect to set the mode.

Waveform Measurement
Meas Setup

Preset	RMS
State Saved	Saved in instrument state.
Range	Pwr Avg(RMS) Log-Pwr Avg(Video) Voltage Avg
Initial S/W Revision	Prior to A.02.00
Modified at S/W Revision	A.03.00

HW Averaging

Changes the number of time averages is to be made using hardware. This averaging is much faster than the standard averaging done in software. The hardware averaging is done on the complex voltage time trace data before any measurement application averaging is done. Both types of averaging (HW and SW) can be done on the same measurement data.

When time averaging is being done in HW, each trace update represents N fresh data acquisitions averaged together, where N is the number of averages. You cannot access the individual time data. Note that in the spectrum measurement this averaging is done prior to the standard averaging done within the application. Thus the yellow trace in this measurement shows the result of the time averaging. Subsequent averaging is orthogonal to this hardware based time averaging and its result is seen as the blue trace in this and other applications.

So it is possible to turn off the averaging within the application but still have the HW averaging set to a certain number. In other words, turning averaging off within the measurement will not affect HW averaging. If HW averaging needs to be turned off, simply set the HW Averaging parameter to 1.

Since it is time averaging, a trigger source something other than Free Run should be used to avoid cancelling out the signal to be measured. It is most useful for a periodic signal with known periods.

Time Avg Num

Sets the number of HW averages to be executed per each data acquisition.

Key Path	Meas Setup
Mode	BASIC
Remote Command	[:SENSe] :WAVeform:AVERage:TACount <integer> [:SENSe] :WAVeform:AVERage:TACount?
Example	WAV:AVER:TAC 10 WAV:AVER:TAC?
Notes	This feature is only available with PXA or when Option B40 is installed.
Preset	1
State Saved	Saved in instrument state
Min	1
Max	65535

Default Unit	Enter
--------------	-------

Sample Rate

Enables you to set an arbitrary sample rate for the acquired data to be processed.

Key Path	Meas Setup
Mode	BASIC
Remote Command	[:SENSe] :WAVeform :SRATe <freq> [:SENSe] :WAVeform :SRATe?
Example	WAV:SRAT 1.3636 MHz
Notes	Command and query available with PXA or when Option B40 is installed. For other configuration, only query is available.
Couplings	The coupling between Sample Rate and IF BW depends on Physics implementation.
Preset	125.0 kHz
Min	12.5 Hz
Max	(For PXA or Option B40) Digital IF 10 MHz path: 12.5 MHz Digital IF 25 MHz path: 31.25 MHz Digital IF 40 MHz path: 50 MHz Option B1X 140 MHz path: 175 MHz Option B1Y 160 MHz path: 200 MHz (For all other configuration) 10 MHz path: 15 MHz Option B25 25 MHz path: 45 MHz

Sample Period (Aperture) Setting (Remote Command Only)

Returns the time between samples (sample period or aperture).

Mode	BASIC
Remote Command	[:SENSe] :WAVeform :APERture?
Example	WAV:APER?
Notes	Query only.
Couplings	Coupled to Sample Rate by the following equation. Sample Period = 1/(Sample Rate)

Waveform Measurement
Meas Setup

Preset	1/(Sample Rate Default)
Min	1/(Max Sample Rate)
Max	1/(Min Sample Rate)

Meas Time

Sets how long the measurement is performed. X Scale only changes the representation of the display.

Key Path	Meas Setup
Mode	BASIC, PN, WCDMA, C2K, GSM, WIMAX OFDMA, TD-SCDMA, 1xEV-DO, DVB-T/H, DTMB (CTTB), ISDB-T, CMMB, LTE, LTETDD, Digital Cable TV, WLAN, MSR
Remote Command	[:SENSe] :WAVeform :SWEep :TIME <time> [:SENSe] :WAVeform :SWEep :TIME?
Example	WAV:SWE:TIME 50 ms WAV:SWE:TIME?
Notes	Specifies and returns how long the measurement is performed. It is the time record length of the measurement waveform. The Max time may be reduced when the sample frequency is high due to the memory limitation. You must be in a mode that includes the Waveform measurement to use this command. Use INSTRument:SElect to set the mode.
Preset	2.000000 ms
State Saved	Saved in instrument state.
Range	1.000 (s to 100.00 s)
Initial S/W Revision	Prior to A.02.00
Modified at S/W Revision	A.03.00

PhNoise Opt

Selects the LO (local oscillator) phase noise behavior for various desired operating conditions.

Key Path	Meas Setup
Remote Command	[:SENSe] :WAVeform :FREQuency :SYNTHeSis [:STATe] 1 2 3 [:SENSe] :WAVeform :FREQuency :SYNTHeSis [:STATe] ?
Example	WAV:FREQ:SYNT 2 Selects optimization for best wide offset phase noise

Notes	<p>Parameter:</p> <ol style="list-style-type: none"> 1 optimizes phase noise for small frequency offsets from the carrier. 2 optimizes phase noise for wide frequency offsets from the carrier. 3 optimizes LO for tuning speed <p>(In PXA, the local oscillator hardware provides for extra-low phase noise at the expense of some speed.)</p>
Dependencies	Does not appear in all models. The key is blank in those models, but the SCPI command is accepted for compatibility (although no action is taken).
Preset	Because this function is in Auto after preset, and because Digital IF BW after preset < 150 kHz for MXA/EXA and > 400 kHz for PXA the state of this function after Preset will be 1 for MXA/EXA and 2 for PXA.
State Saved	Saved in instrument state.
Min	1
Min	1
Max	3
Initial S/W Revision	Prior to A.07.00
Modified at S/W Revision	A.07.00

Auto

Selects the LO (local oscillator) phase noise behavior to optimize dynamic range and speed for various instrument operating conditions.

The X-Series has two grades of LO; a high performance LO that gives the best phase noise performance; and a medium-performance LO that gives excellent performance.

In models with the high performance LO, Auto will choose:

	Best Close in Phase Noise	Best Wide-offset Phase Noise
Filter BW	400 kHz	> 400 kHz

In models with the medium-performance LO, Auto will choose:

	Best Close in Phase Noise	Best Wide-offset Phase Noise
Filter BW	150 kHz	>150 kHz

Waveform Measurement
Meas Setup

Note that Fast Tuning will not be selected when in Auto.

Key Path	Meas Setup, PhNoise Opt
Remote Command	[:SENSe] :WAVeform:FREQuency:SYNTHeSis:AUTO[:STATe] OFF ON 0 1 [:SENSe] :WAVeform:FREQuency:SYNTHeSis:AUTO[:STATe] ?
Example	WAV:FREQ:SYNT:AUTO ON
Preset	ON
State Saved	Saved in instrument state.
Initial S/W Revision	Prior to A.07.00

Best Close-in P Noise

The LO phase noise is optimized for smaller offsets from the carrier, at the expense of phase noise farther out.

Key Path	Meas Setup, PhNoise Opt
Example	WAV:FREQ:SYNT 1
Couplings	The frequency below which the phase noise is optimized is model dependent: CXA: n/a EXA: [offset 150 kHz] MXA: [offset 150 kHz] PXA: [offset 400 kHz]
Readback	Close-in. If manually selected, “Man” will be underlined. The actual frequency offset within which noise is optimized is shown with in square brackets, as this can vary depending on the hardware set in use. For example, in some analyzers this annotation appears as [offset <150 kHz]
Initial S/W Revision	Prior to A.07.00

Best Wide-offset P Noise

The LO phase noise is optimized for wider offsets from the carrier. Closer offsets are compromised and the throughput of measurements (especially remote measurements where the center frequency is changing rapidly), is reduced.

Key Path	Meas Setup, PhNoise Opt
Example	WAV:FREQ:SYNT 2

Couplings	The frequency below which the phase noise is optimized is model dependent: CXA: n/a EXA: [offset >150 kHz] MXA: [offset >150 kHz] PXA: [offset >400 kHz]
Readback	Wide-offset. If manually selected, “Man” will be underlined. The actual frequency offset beyond which noise is optimized is shown with in square brackets, as this can vary depending on the hardware set in use. For example, in some analyzers this annotation appears as [offset >150 kHz]
Initial S/W Revision	Prior to A.07.00

Advanced

Accesses a menu of advanced functions that are used for specific applications. These settings should not be changed for most measurements.

Key Path	Meas Setup
Initial S/W Revision	Prior to A.02.00

ADC Dither

Accesses the ADC Dither control menu.

Key Path	Meas Setup, Advanced
Initial S/W Revision	Prior to A.02.00

ADC Dither Auto

Sets ADC dithering to automatically select whether dithering is needed.

Key Path	Meas Setup, Advanced, ADC Dither
Mode	BASIC, PN, WCDMA, C2K, GSM, WIMAX OFDMA, TD-SCDMA, 1xEV-DO, DVB-T/H, DTMB (CTTB), ISDB-T, CMMB, LTE, LTETDD, Digital Cable TV, WLAN, MSR
Remote Command	[:SENSe] :WAVeform:ADC:DITHer:AUTO[:STATe] OFF ON 0 1 [:SENSe] :WAVeform:ADC:DITHer:AUTO[:STATe] ?
Example	WAV:ADC:DITH:AUTO ON WAV:ADC:DITH:AUTO?

Waveform Measurement
Meas Setup

Notes	The dither function improves linearity for low level signals, at the expense of a higher noise floor. You must be in a mode that includes the Waveform measurement to use this command. Use INSTRument:SElect to set the mode.
Preset	OFF
State Saved	Saved in instrument state.
Range	On Off
Initial S/W Revision	Prior to A.02.00
Modified at S/W Revision	A.03.00

ADC Dither

Toggles the dither function On and Off. The dither function improves linearity for low level signals, at the expense of a higher noise floor.

The reduced clipping-to-noise ratio results in higher noise, because the clipping level of the ADC relative to the front terminals remains unchanged with the introduction of dither. The enhanced linearity is mostly improved scale fidelity.

With dither on, the third-order distortions are usually invisible for mixer levels below -35 dBm. With dither off, these distortions can be visible, with typical power levels of -110 dBm referred to the mixer. Detection nonlinearity can reach 1 dB for dither off at mixer levels around -70 dBm and lower, while the specified nonlinearity is many times smaller with dither on.

Key Path	Meas Setup, Advanced, ADC Dither
Mode	BASIC, PN, WCDMA, C2K, GSM, WIMAX OFDMA, TD-SCDMA, 1xEV-DO, DVB-T/H, DTMB (CTTB), ISDB-T, CMMB, LTE, LTETDD, Digital Cable TV, WLAN, MSR
Remote Command	[:SENSe] :WAVeform:ADC:DITHer [:STATe] OFF ON 0 1 [:SENSe] :WAVeform:ADC:DITHer [:STATe] ?
Example	WAV:ADC:DITH ON WAV:ADC:DITH?
Notes	The dither function improves linearity for low level signals, at the expense of a higher noise floor. . You must be in a mode that includes the Waveform measurement to use this command. Use INSTRument:SElect to set the mode.
Preset	OFF
State Saved	Saved in instrument state.
Range	Auto Man
Backwards Compatibility SCPI	[:SENSe] :WAVeform:WBIF:ADC:DITHer [:SENSe] :WAVeform:PDITHer

Initial S/W Revision	Prior to A.02.00
Modified at S/W Revision	A.03.00

IF Gain

Accesses the keys to select the IF Gain settings.

When in Autorange mode, the IF checks its range once for data acquisition, to provide the best signal to noise ratio. You can specify the range for the best speed, and optimize for noise or for large signals.

When the IF Gain is set to Autorange, the IF Gain is set to High initially for each chunk of data. The data is then acquired. If the IF overloads, then the IF Gain is set to Low and the data is re-acquired. Because of this operation, the Autorange setting uses more measurement time as the instrument checks/resets its range. You can get faster measurement speed by forcing the range to either the high or low gain setting. But you must know that your measurement conditions will not overload the IF (in the high gain range) and that your signals are well above the noise floor (for the low gain range), and that the signals are not changing.

When Digital Bus Out (under the Input/Output menu) is ON, the IF Gain State Autorange selection is not allowed. Thus, in this case, IF Gain State will be set to Low.

This only applies to the RF input. It does not apply to baseband I/Q input.

Key Path	Meas Setup, Advanced
Initial S/W Revision	Prior to A.02.00

IF Gain Auto

Activates the auto rules for IF Gain

Key Path	Meas Setup, Advanced, IF Gain
Mode	BASIC, PN, WCDMA, C2K, GSM, WIMAX OFDMA, TD-SCDMA, 1xEV-DO, DVB-T/H, DTMB (CTTB), ISDB-T, CMMB, LTE, LTETDD, Digital Cable TV, WLAN, MSR
Remote Command	[:SENSe] :WAVeform :IF :GAIN :AUTO [:STATe] ON OFF 1 0 [:SENSe] :WAVeform :IF :GAIN :AUTO [:STATe] ?
Example	WAV:IF:GAIN:AUTO ON WAV:IF:GAIN:AUTO?
Notes	This only applies to the RF input. It does not apply to baseband I/Q input. You must be in a mode that includes the Waveform measurement to use this command. Use INSTRument:SElect to set the mode.
Preset	ON
State Saved	Saved in instrument state.
Range	On Off

Waveform Measurement
Meas Setup

Initial S/W Revision	Prior to A.02.00
Modified at S/W Revision	A.03.00

IF Gain State

Selects the range of IF gain.

Key Path	Meas Setup, Advanced, IF Gain
Mode	BASIC, PN, WCDMA, C2K, GSM, WIMAX OFDMA, TD-SCDMA, 1xEV-DO, DVB-T/H, DTMB (CTTB), ISDB-T, CMMB, LTE, LTETDD, Digital Cable TV, WLAN, MSR
Remote Command	[:SENSe] :WAVeform:IF:GAIN[:STATe] AUTOrange LOW HIGH [:SENSe] :WAVeform:IF:GAIN[:STATe] ?
Example	WAV:IF:GAIN HIGH WAV:IF:GAIN?
Notes	This only applies to the RF input and does not apply to baseband I/Q input. You must be in a mode that includes the Waveform measurement to use this command. Use INSTRument:SElect to set the mode. If the user tries to select Autorange while Digital Bus Out is ON, an error message –221 “Settings conflict; “IF Gain Autorange not allowed when Digital Bus Out is ON” is displayed.
Couplings	If the user tries to select Autorange via SCPI while Digital Bus Out is ON, an error message –224, “Illegal parameter value; “IF Gain Autorange not allowed when Digital Bus Out is on” is displayed. If the user tries to select Autorange via front panel while Digital Bus Out is ON, an advisory message “IF Gain Autorange not allowed when Digital Bus Out is on” is displayed.
Preset	LOW
State Saved	Saved in instrument state.
Range	Autorange (Slower Follows Signals) Low (Best for Large Signals) High (Best Noise Level)
Readback Text	Autorange Low High
Initial S/W Revision	Prior to A.02.00
Modified at S/W Revision	A.03.00

IF Gain Offset

Sets the IF Gain offset for the 40 MHz and 140 MHz IF Paths in 2 dB step from –6 dB to +6 dB. Increasing the gain can increase the amplitude of small signals as long as you do not overdrive the hardware. Wideband gain should usually be adjusted after setting the input attenuation.

Internally, the IF Gain value will change based on the current configuration of the hardware. If you

choose to offset this value, you may do so with this parameter. The value specified is not an absolute value but relative to the current internal IF Gain setting.

For example:

IF Gain Low + IF Gain Offset +4 dB = Total IF Gain of +4 dB ($0 + 4 = 4$)

IF Gain High + IF Gain Offset +4 dB = Total IF Gain of +14 dB ($10 + 4 = 14$)

IF Gain Low + IF Gain Offset -6 dB = Total IF Gain of -6 dB ($0 - 6 = -6$)

IF Gain High + IF Gain Offset -6 dB = Total IF Gain of +6 dB ($10 - 6 = 4$)

The total IF Gain range when IF Gain Offset is available is a minimum of $0 - 6 = -6$ dB and a maximum of $10 + 6 = 16$ dB. The available IF Gain depends on the IF Path and center frequency. The maximum IF Gain may not be achievable at all times depending on the configuration.

Key Path	Meas Setup, Advanced
Remote Command	[:SENSe] :WAVeform :IF :GAIN :OFFSet <rel_ampl > [:SENSe] :WAVeform :IF :GAIN :OFFSet ?
Example	WAV : IF : GAIN : OFFS 2 Sets the IF Gain offset to 2
Preset	0
State Saved	Saved in instrument state.
Min	-6
Max	+6
Default Unit	dB

Meas Preset

Restores all the measurement parameters to their default values.

Key Path	Meas Setup
Mode	BASIC, PN, WCDMA, C2K, GSM, WIMAX OFDMA, TD-SCDMA, 1xEV-DO, DVB-T/H, DTMB (CTTB), ISDB-T, CMMB, LTE, LTETDD, Digital Cable TV, WLAN, MSR
Remote Command	:CONFIgure :WAVeform
Example	CONF:WAV
Notes	Restore default values of all parameters. You must be in a mode that includes the Waveform measurement to use this command. Use INSTRument:SElect to set the mode.
Initial S/W Revision	Prior to A.02.00
Modified at S/W Revision	A.03.00

Mode

For details on this key, see [“Mode” on page 1534](#)

Key Path	Front-panel key
----------	-----------------

Mode Setup

For details on this key, see [“Mode Setup” on page 1553](#).

Key Path	Front-panel key
----------	-----------------

Peak Search

Places the selected marker on the trace point with the maximum y-axis value for that marker's trace and accesses a menu that enables you to select to do a next peak or minimum peak search.

Key Path	Front-panel key
Mode	BASIC, PN, WCDMA, C2K, GSM, WIMAX OFDMA, TD-SCDMA, 1xEV-DO, DVB-T/H, DTMB (CTTB), ISDB-T, CMMB, LTE, LTETDD, Digital Cable TV, WLAN, MSR
Remote Command	:CALCulate:WAVEform:MARKer[1] 2 3 4 5 6 7 8 9 10 11 12:MAXimum
Example	CALC:WAV:MARK2:MAX
Notes	You must be in a mode that includes the Waveform measurement to use this command. Use INSTRument:SElect to set the mode.
Initial S/W Revision	Prior to A.02.00
Modified at S/W Revision	A.03.00

Next Peak

Moves the selected marker to the next highest local maximum with a value less than the current marker's.

Key Path	Peak Search
Mode	BASIC, PN, WCDMA, C2K, GSM, WIMAX OFDMA, TD-SCDMA, 1xEV-DO, DVB-T/H, DTMB (CTTB), ISDB-T, CMMB, LTE, LTETDD, Digital Cable TV, WLAN, MSR
Remote Command	:CALCulate:WAVEform:MARKer[1] 2 3 4 5 6 7 8 9 10 11 12:MAXimum:NEXT
Example	CALC:WAV:MARK:MAX:NEXT
Notes	You must be in a mode that includes the Waveform measurement to use this command. Use INSTRument:SElect to set the mode.
Initial S/W Revision	Prior to A.02.00
Modified at S/W Revision	A.03.00

Min Search

Moves the selected marker to the minimum y-axis value on the current trace.

Key Path	Peak Search
----------	-------------

Mode	BASIC, PN, WCDMA, C2K, GSM, WIMAX OFDMA, TD-SCDMA, 1xEV-DO, DVB-T/H, DTMB (CTTB), ISDB-T, CMMB, LTE, LTETDD, Digital Cable TV, WLAN, MSR
Remote Command	:CALCulate:WAVEform:MARKer[1 2 3 4 5 6 7 8 9 10 11 12]:MINimum
Example	CALC:WAV:MARK:MIN
Notes	You must be in a mode that includes the Waveform measurement to use this command. Use INSTRUMENT:SElect to set the mode.
Initial S/W Revision	Prior to A.02.00
Modified at S/W Revision	A.03.00

Recall

For details on this key, see [“Recall” on page 194](#).

Key Path	Front-panel key
----------	-----------------

Restart

For details on this key, see [“Restart” on page 1558](#).

Key Path	Front-panel key
----------	-----------------

Save

For details on this key, see [“Save” on page 207](#) .

Key Path	Front-panel key
----------	-----------------

Single

For details on this key, see “[Single \(Single Measurement/Sweep\)](#)” on page 1563 .

Key Path	Front-panel key
----------	-----------------

Source

Operation of this key is identical across all measurements. For details about this key, see [“Source” on page 1564](#) in the section "Common Measurement Functions" for more information.

Key Path	Front-panel key
----------	-----------------

Span X Scale

Accesses a menu of functions that enable you to set the horizontal scale parameters.

Key Path	Front-panel key
Initial S/W Revision	Prior to A.02.00

Ref Value

Sets the reference value for time on the horizontal axis. When Auto Scaling is set to On, the displayed plots use a Scale/Div value determined by the analyzer, based on the measurement result.

Key Path	SPAN X Scale
Mode	BASIC, PN, WCDMA, C2K, GSM, WIMAX OFDMA, TD-SCDMA, 1xEV-DO, DVB-T/H, DTMB (CTTB), ISDB-T, CMMB, LTE, LTETDD, Digital Cable TV, WLAN, MSR
Remote Command	:DISPlay:WAVEform:VIEW[1] 2:WINDow[1]:TRACe:X[:SCALE]:RLEVEL <time> :DISPlay:WAVEform:VIEW[1] 2:WINDow[1]:TRACe:X[:SCALE]:RLEVEL?
Example	DISP:WAV:VIEW:WIND:TRAC:X:RLEV 10 ms DISP:WAV:VIEW:WIND:TRAC:X:RLEV?
Notes	You must be in a mode that includes the Waveform measurement to use this command. Use INSTRument:SElect to set the mode.
Couplings	If Auto Scaling is set to On, this value is automatically determined by the measurement result. When you set this value manually, Auto Scaling automatically changes to Off.
Preset	0.00 s
State Saved	Saved in instrument state.
Min	-1.000 s
Max	10.00 s
Initial S/W Revision	Prior to A.02.00
Modified at S/W Revision	A.03.00

Scale/Div

Sets the horizontal scale by changing a time value per division.

Key Path	SPAN X Scale
----------	---------------------

Waveform Measurement
Span X Scale

Mode	BASIC, PN, WCDMA, C2K, GSM, WIMAX OFDMA, TD-SCDMA, 1xEV-DO, DVB-T/H, DTMB (CTTB), ISDB-T, CMMB, LTE, LTETDD, Digital Cable TV, WLAN, MSR
Remote Command	:DISP:WAVEform:VIEW[1] 2:WINDow[1]:TRACe:X[:SCALE]:PDIVision <time> :DISP:WAVEform:VIEW[1] 2:WINDow[1]:TRACe:X[:SCALE]:PDIVision?
Example	DISP:WAV:VIEW:WIND:TRAC:X:PDIV 500 us DISP:WAV:VIEW:WIND:TRAC:X:PDIV?
Notes	You must be in a mode that includes the Waveform measurement to use this command. Use INSTRument:SElect to set the mode.
Couplings	If Auto Scaling is set to On, this value is automatically determined by the measurement result. When you set this value manually, Auto Scaling automatically changes to Off.
Preset	200.0 us
State Saved	Saved in instrument state.
Min	1.000 ns
Max	1.000 s
Initial S/W Revision	Prior to A.02.00
Modified at S/W Revision	A.03.00

Ref Position

Sets the reference position for the X axis to Left, Center or Right.

Key Path	SPAN X Scale
Mode	BASIC, PN, WCDMA, C2K, GSM, WIMAX OFDMA, TD-SCDMA, 1xEV-DO, DVB-T/H, DTMB (CTTB), ISDB-T, CMMB, LTE, LTETDD, Digital Cable TV, WLAN, MSR
Remote Command	:DISP:WAVEform:VIEW[1] 2:WINDow[1]:TRACe:X[:SCALE]:RPOSition LEFT CENTER RIGHT :DISP:WAVEform:VIEW[1] 2:WINDow[1]:TRACe:X[:SCALE]:RPOSition?
Example	DISP:WAV:VIEW:WIND:TRAC:X:RPOS LEFT DISP:WAV:VIEW:WIND:TRAC:X:RPOS?
Notes	Allows you to set the reference position to Left, Ctr (center) or Right. You must be in a mode that includes the Waveform measurement to use this command. Use INSTRument:SElect to set the mode.
Preset	LEFT

State Saved	Saved in instrument state.
Range	Left Ctr Right
Initial S/W Revision	Prior to A.02.00
Modified at S/W Revision	A.03.00

Auto Scaling

Toggles the scale coupling function between On and Off.

Key Path	SPAN X Scale
Mode	BASIC, PN, WCDMA, C2K, GSM, WIMAX OFDMA, TD-SCDMA, 1xEV-DO, DVB-T/H, DTMB (CTTB), ISDB-T, CMMB, LTE, LTETDD, Digital Cable TV, WLAN, MSR
Remote Command	:DISPlay:WAVEform:VIEW[1] 2:WINDow[1]:TRACe:X[:SCALe]:COUPle 0 1 OFF ON :DISPlay:WAVEform:VIEW[1] 2:WINDow[1]:TRACe:X[:SCALe]:COUPle?
Example	DISP:WAV:VIEW:WIND:TRAC:X:COUP ON DISP:WAV:VIEW:WIND:TRAC:X:COUP?
Notes	You must be in a mode that includes the Waveform measurement to use this command. Use INSTRument:SElect to set the mode.
Couplings	When Auto Scaling is On and the Restart front-panel key is pressed, this function automatically determines the scale per division and reference values based on the measurement results. When you set a value to either Scale/Div or Ref Value manually, Auto Scaling automatically changes to Off.
Preset	1
State Saved	Saved in instrument state.
Range	On Off
Initial S/W Revision	Prior to A.02.00
Modified at S/W Revision	A.03.00

Sweep/Control

Accesses the Sweep menu that allows you to pause and restart the measurement.

For more information, see [“Sweep/Control” on page 1564](#).

Key Path	Front-panel key
Initial S/W Revision	Prior to A.02.00

Pause and Resume

Pauses a measurement after the current data acquisition is complete. When Paused, the label on the key changes to Resume. Pressing the Resume key resumes the measurement at the point it was at when paused.

For more information, see [“Pause/Resume” on page 1577](#).

Key Path	Sweep/Control
Initial S/W Revision	Prior to A.02.00

Trace/Detector

There is no Trace/Detector functionality supported in the Waveform measurement. The front-panel key displays a blank menu when pressed.

Key Path	Front-panel key
Initial S/W Revision	Prior to A.02.00

Trigger

Accesses a menu of functions that enable you to select and control the trigger source for the current measurement

For more information, see [“Trigger” on page 1595](#).

Key Path	Front-panel key
Initial S/W Revision	Prior to A.02.00

View/Display

Accesses a menu of functions that enable you to set up and control the display parameters for the current measurement.

This topic contains the following sections:

[“View Selection by name \(Remote Command Only\)” on page 1335](#)

[“View Selection by number \(Remote Command Only\)” on page 1335](#)

View Selection by name (Remote Command Only)

Selects the results view.

Key Path	View/Display
Mode	BASIC, PN, WCDMA, C2K, GSM, WIMAX OFDMA, TD-SCDMA, 1xEV-DO, DVB-T/H, DTMB (CTTB), ISDB-T, CMMB, LTE, LTETDD, Digital Cable TV, WLAN, MSR
Remote Command	:DISPlay:WAVeform:VIEW[:SElect] RFENvelope IQ :DISPlay:WAVeform:VIEW[:SElect]?
Example	DISP:WAV:VIEW RFEN DISP:WAV:VIEW?
Notes	You must be in a mode that includes the Waveform measurement to use this command. Use INSTRument:SElect to set the mode.
Preset	RFENveloper
State Saved	Saved in instrument state.
Range	RF Envelope IQ Waveform
Initial S/W Revision	Prior to A.02.00
Modified at S/W Revision	A.03.00

View Selection by number (Remote Command Only)

Displays the numeric values of the measurement results.

Mode	BASIC, PN, WCDMA, C2K, GSM, WIMAX OFDMA, TD-SCDMA, 1xEV-DO, DVB-T/H, DTMB (CTTB), ISDB-T, CMMB, LTE, LTETDD, Digital Cable TV, WLAN, MSR
Remote Command	:DISPlay:WAVeform:VIEW:NSElect <integer> :DISPlay:WAVeform:VIEW:NSElect?
Example	DISP:WAV:VIEW:NSEL 1 DISP:WAV:VIEW:NSEL?

Waveform Measurement

View/Display

Notes	You must be in a mode that includes the Waveform measurement to use this command. Use INSTRument:SElect to set the mode.
Preset	1
State Saved	Saved in instrument state.
Min	1
Max	2
Initial S/W Revision	Prior to A.02.00
Modified at S/W Revision	A.03.00

Key Path	Front-panel key
Initial S/W Revision	Prior to A.02.00

Display

Accesses a menu of functions that enable you to set the display parameters.

For more information, see [“Display” on page 1646](#).

Key Path	View/Display
Initial S/W Revision	Prior to A.02.00

RF Envelope

This view shows an example of the RF Envelope result for the waveform (time domain) measurements in the graph window. The measured values for the mean power and peak-to-mean power are shown in the text window.

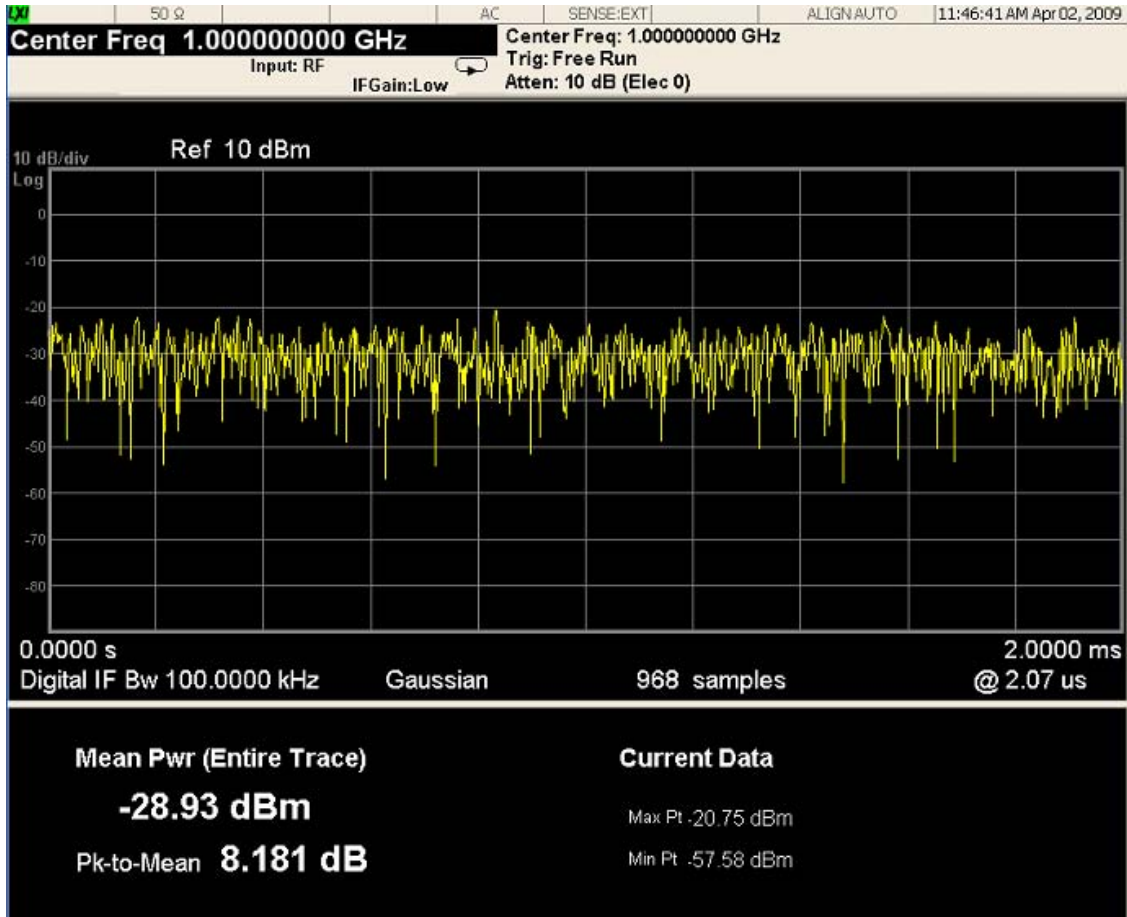

Numeric Results

Name	Type	Description	Unit	Format
Mean Pwr	Float64	The mean power (dBm). This is either the power across the entire trace, or the power between markers if the markers are enabled.	dBm	XX.XX dBm
Pk-to-Mean	Float64	This is the ratio of the maximum signal level to the mean power.	dB	XX.XX dB
Max Pt	Float64	The maximum of the most recently acquired data.	dBm	XX.XX dBm
Min Pt	Float64	The minimum of the most recently acquired data.	dBm	XX.XX dBm

Key Path	View/Display
Initial S/W Revision	Prior to A.02.00

I/Q Waveform

This view shows the I and Q signal waveforms in parameters of voltage versus time.



Key Path	View/Display
Initial S/W Revision	Prior to A.02.00

The CEVM measurement allows you to measure LTE signals according to 3GPP TS 36.211. The measurement supports all LTE bandwidths plus all modulation formats and sequences for both downlink (OFDMA) and uplink (SC-FDMA) analysis. Once you have configured the measurement, you can use these commands to initiate the measurement and retrieve the measurement results.

For information on how to make measurement using the X-Series Signal Analyzer, see:

Measurement Guide [n9080-90006.pdf].

[“Measurement Commands for CEVM ” on page 1339](#)

[“Remote Command Results for CEVM Measurement” on page 1339](#)

Measurement Commands for CEVM

This section details remote commands and results. For the front-panel configuration and results, see [“View/Display” on page 1372](#).

```
:CONFigure:CEVM
:CONFigure:CEVM:NDEFault
:FETCh:CEVM[n]?
:INITiate:CEVM
:MEASure:CEVM[n]?
:READ:CEVM[n]?
```

See [“Remote SCPI Commands and Data Queries” on page 1789](#) and [“Data” on page 1730](#) in Common Functions for more measurement SCPI commands.

Remote Command Results for CEVM Measurement

The following table denotes the Conformance EVM specific results returned from the (FETCh|MEASure|READ):CEVM commands, indexed by subopcode. MEASure:CEVM<n> is equivalent to CONF:CEVM;INIT:IMM:FETCh:CEVM<n>, which gets you the default measurement,

that is, 5 MHz downlink with auto detection of allocations.

N	Results Returned (Downlink)
<p>Not specified or n=1</p>	<p>The total result length is variable. The returned contents may change depending on the result values' enable/disable setting described in “Result Values” on page 1356. By default, it returns 28 comma-separated scalar results, corresponding exactly to the items shown at Result Metrics View.</p> <ol style="list-style-type: none"> 1. EVM (%rms) 2. EVM Sym Time Adjust 3. EVM Pk (%) 4. EVM Pk Index 5. EVM Peak Sub Car Index 6. Data EVM (%rms) – Not available when Detection is Manual and no User is added. 7. 3GPP-defined QPSK EVM (%rms) 8. 3GPP-defined 16QAM EVM (%rms) 9. 3GPP-defined 64QAM EVM (%rms) 10. RS EVM (%rms) 11. RS Tx. Power (dBm). 12. OFDM Sym. Tx. Power (dBm) 13. Freq Error (Hz) 14. Sync Corr (%) 15. Sync Type 16. Common Tracking Error (%rms) 17. Symbol Clock Error (ppm) 18. Time Offset (s) 19. IQ Offset (dB) 20. IQ Gain Imbalance (dB) 21. IQ Quad Error (deg) 22. IQ Timing Skew (s) 23. CP Length Mode 24. Cell ID. 25. Cell ID Group/Sector 26. RS-OS/PRS 27. Reference Signal Rx Power (Avg) 28. Reference Signal Rx Quality

N	Results Returned (Uplink)
<p>Not specified or n=1</p>	<p>The total result length is variable. The returned contents may change depending on the result values' enable/disable setting described in “Result Values” on page 1356. By default, it returns 23 comma-separated scalar results, corresponding exactly to the items shown at Result Metrics View.</p> <ol style="list-style-type: none"> 1. EVM (%rms) 2. EVM Sym Time Adjust 3. EVM Pk (%) 4. EVM Pk Index 5. EVM Peak Sub Car Index 6. Data EVM (%rms) – Not available when Detection is Manual and no User is added. 7. 3GPP-defined QPSK EVM (%rms) 8. 3GPP-defined 16QAM EVM (%rms) 9. 3GPP-defined 64QAM EVM (%rms) 10. RS EVM (%rms) 11. -999.0 returned. 12. -999.0 returned. 13. Freq Error (Hz) 14. Sync Corr (%) 15. Sync Type 16. Common Tracking Error (%rms) 17. Symbol Clock Error (ppm) 18. Time Offset (s) 19. IQ Offset (dB) 20. IQ Gain Imbalance (dB) 21. IQ Quad Error (deg) 22. IQ Timing Skew (s) 23. CP Length Mode
<p>n=2</p>	<p>Returns result of Eq Chan Freq Resp Per Slot. The result length varies depending on the Bandwidth and Measurement Interval.</p> <p>For example, BW=5MHz and Result Length & Meas Interval Slot = 20 slots, 6000 points are returned. The first 300 points are the EQ response of Slot 0 from the lowest to the highest frequency, and the second 300 points are that of Slot 1, and so on. Each slot (=EC(f)) is divided into EC_1(f) for Range1 and EC_2(f) for Range2, and then RP1, RP2, RP12 or RP21 is calculated in each region.</p>

Key Path	Meas
----------	------

Conformance EVM

Mode	LTE, LTETDD
Initial S/W Revision	A.06.30
Modified at S/W Revision	A.10.01

Amplitude (AMPTD) Y Scale

See AMPTD Y Scale, “[AMPTD Y Scale](#)” on page 1379 for details.

Key Path	Front-panel key
----------	-----------------

Attenuation

See AMPTD Y Scale, “[Attenuation](#)” on page 1381 for details.

Presel Center

See AMPTD Y Scale, “[Presel Center](#)” on page 1396 for details.

Presel Adjust

See AMPTD Y Scale, “[Preselector Adjust](#)” on page 1398.

μ W Path Control

See “ [\$\mu\$ W Path Control](#)” on page 1405 under AMPTD Y Scale for details.

Internal Preamp

See AMPTD Y Scale, “[Internal Preamp](#)” on page 1410 for details.

Auto Couple

See AMPTD Y Scale, “[Auto Couple](#)” on page 1412 for details.

Key Path	Front-panel key
----------	------------------------

BW

Info BW is a SCPI only parameter. No softkey is available.

Key Path	Front-panel key
----------	-----------------

Info BW

Sets the information bandwidth. SCPI only.

Key Path	SCPI only
Mode	LTE, LTETDD
Remote Command	[:SENSe] :CEVM:IFBW <freq> [:SENSe] :CEVM:IFBW?
Example	CEVM:IFBW 5MHZ CEVM:IFBW?
Notes	SCPI only. Some DIFs only have discrete IF BW settings. In that case, the closest wider BW the HW provides is selected as the Info BW. Info BW is optimized for the measurement speed. Although the user can change this, it could cause a measurement speed degradation especially in DIF cases with Opt.DP2.
Couplings	Info BW is automatically overwritten whenever Demod Bandwidth is changed. The following shows the relation between Demod Bandwidth in Mode Parameter and Info BW. Demod BandwidthInfo BW 1.4 MHz3.072 MHz 3 MHz6.144 MHz 5 MHz6.144 MHz 10 MHz12.288 MHz 15 MHz24.576 MHz 20 MHz24.576 MHz
Preset	6.144 MHz
State Saved	Saved in instrument state.
Min	1kHz
Max	Lower value of either Digital IF max value or 49.152MHz.
Initial S/W Revision	A.06.30

Cont (Continuous)

See “[Cont \(Continuous Measurement/Sweep\)](#)” on page 1413 for details.

Key Path	Front-panel key
----------	------------------------

FREQ Channel

See “FREQ Channel” on page 1414 for details.

Key Path	Front-panel key
----------	-----------------

Center Freq

See “Center Freq” on page 1415 for details.

CF Step

See “CF Step” on page 1421 for details.

Input/Output

See “[Input/Output](#)” on page 1422 for details.

Key Path	Front-panel key
----------	-----------------

Marker

There is no Marker functionality implemented in this measurement.

Key Path	Front-panel key
----------	-----------------

Marker Fctn

There is no Marker functionality implemented in this measurement.

Key Path	Front-panel key
----------	-----------------

Marker > (Marker To)

There is no Marker To functionality implemented in this measurement.

Key Path	Front-panel key
----------	-----------------

Meas

See “[Meas](#)” on page 1520 for details.

Key Path	Front-panel key
----------	-----------------

Meas Setup

Only Copy from Mod Analysis and Meas Preset are available in the Meas Setup menu. The other functions are performed using Remote Commands documented in the following sections, or via setup tables, using the front-panel keys or a mouse and keyboard.

For more information on the measurement setup table screens, see:

Section “[Measurement List view](#)” on page 1372 and

Section “[Parameter List view](#)” on page 1373

Key Path	Front-panel key
Initial S/W Revision	A.06.30

Meas Method (PXA with option B1X or B1Y only)

Selects the desired method for the CEVM measurement. This feature is only available on PXA with 140 MHz or 160 MHz analysis bandwidth option.

- NORMal – Measurement speed is not optimized.
- FAST – Measurement speed is optimized and faster than NORMal. However, measurement settings are limited even in the valid combination of the parameter values. The limitations of Fast mode, see “[Fast Mode Limitation](#)” on page 1353.

Key Path	Meas Setup
Mode	LTE, LTETDD
Remote Command	[:SENSe] :CEVM:METHod NORMal FAST [:SENSe] :CEVM:METHod?
Example	CEVM:METH FAST CEVM:METH?
Dependencies	This parameter is available only when the Wideband DIF (B1X) hardware is installed in the instrument.
State Saved	Saved in instrument state.
Range	Normal Fast
Initial S/W Revision	A.10.01

Fast Mode Limitation

- For downlink signals, Fast mode can only be used for E-UTRA test models, the setup files can be recalled by using Recall, Data, EVM Setup.
- For uplink signals, fast mode only supports channel configuration for PUSCH, other channels such as

Conformance EVM
Meas Setup

PUCCH are not supported. Multiple users are not supported for Fast Mode. The auto function of the parameters must be OFF and see the table below for parameter values, others must be preset value.

Name	SCPI	Fast Mode
RB Auto Detection	[:SENSe]:CEVM:PROFile:AUTO[:DETEct]	OFF
Analysis Boundary	[:SENSe]:CEVM:TIME:ASBoundary	FRAMe
Meas Interval/Offset	[:SENSe]:CEVM:TIME:INTerval:SLOT [:SENSe]:CEVM:TIME:INTerval:SYMBOL [:SENSe]:CEVM:TIME:OFFSet:SLOT [:SENSe]:CEVM:TIME:OFFSet:SYMBOL	Same as Normal Mode
Sync Type	[:SENSe]:CEVM:ULINK:SYNC:TYPE	RS
Cyclic Prefix Length	[:SENSe]:CEVM:ULINK:SYNC:CPLength	NORMAL
Add User	[:SENSe]:CEVM:ULINK:PROFile:ADD:USER	Only USER[1] is valid.
Include PUSCH	[:SENSe]:CEVM:ULINK:PROFile:USER:PUSCh	INCLude
PUSCH Active	[:SENSe]:CEVM:ULINK:PROFile:USER:PUSCh:ACTive	ON
Include PUSCH DMRS	[:SENSe]:CEVM:ULINK:PROFile:USER:PUSCh:DMRS	INCLude
PUSCH Auto Calc Params	[:SENSe]:CEVM:ULINK:PROFile:USER:PUSCh:DMRS:PARams	Same as Normal Mode
PUSCH n DMRS (1)	[:SENSe]:CEVM:ULINK:PROFile:USER:PUSCh:DMRS:ONE	Same as Normal Mode
PUSCH n DMRS (2)	[:SENSe]:CEVM:ULINK:PROFile:USER:PUSCh:DMRS:TWO	Same as Normal Mode
Delta SS	[:SENSe]:CEVM:ULINK:PROFile:USER:PUSCh:DSS	Same as Normal Mode
Add PUSCH Slot	[:SENSe]:CEVM:ULINK:PROFile:USER:PUSCh:ADD:SLOT	Same as Normal Mode
User PUSCH RB Start	[:SENSe]:CEVM:ULINK:PROFile:USER:PUSCh:RB:START	Same as Normal Mode
PUSCH Start RB Couple	[:SENSe]:CEVM:ULINK:PROFile:USER:PUSCh:RB:START:COUple	Same as Normal Mode
PUSCH Common RB End	[:SENSe]:CEVM:ULINK:PROFile:USER:PUSCh:RB:END	Same as Normal Mode
PUSCH End RB Couple	[:SENSe]:CEVM:ULINK:PROFile:USER:PUSCh:RB:END:COUple	Same as Normal Mode

PUSCH Sync Slot	[:SENSe] :CEVM:ULINK:PROFile:USER:P USCh:SSLot	Same as Normal Mode
PUSCH Sync Slot Auto	[:SENSe] :CEVM:ULINK:PROFile:USER:P USCh:SSLot:AUTO	OFF
PUSCH Common Mod Type	[:SENSe] :CEVM:ULINK:PROFile:USER1 50:PUSCh:MODulation:TYPE	Same as Normal Mode
Frequency Hopping	[:SENSe] :CEVM:ULINK:PROFile:USER:P USCh:FHOPping	OFF
Group Hopping	[:SENSe] :CEVM:ULINK:PROFile:USER:H OPping:GROup	Same as Normal Mode
Seq Hopping	[:SENSe] :CEVM:ULINK:PROFile:USER1 50:HOPping:SEQuence	Same as Normal Mode
Equalizer Training	[:SENSe] :CEVM:EQualizer:TRaining	RSData

Copy from Mod Analysis Measurement

This immediate action key provides parameter copy function from Mod Analysis Measurement to CEVM.

NOTE This immediate action copies LTE demodulation parameters from the Mod Analysis Measurement to Conformance EVM Measurement. Note that the other parameters such as Attenuation(Range), Trigger, averaging parameters, IFBW, etc. are NOT copied from Mod Analysis Measurement.

Key Path	Meas Setup
Mode	LTE, LTETDD
Remote Command	[:SENSe] :CEVM:EVM:COpy[:IMMediate]
Example	CEVM:EVM:COpy
Initial S/W Revision	A.06.30

Meas Preset

This immediately sets all measurement parameters to their Preset values. For more information, see the Preset key in the System Functions section.

Key Path	Meas Setup
Mode	LTE, LTETDD
Initial S/W Revision	A.06.30

Result Values

In CEVM, the user can select results displayed in the Result Metrics View. These results are synchronized with the remote SCPI query results for index n=1.

Downlink Result Output Selection

The following table shows the mapping of the Array index and Result parameters.

Index	Result Parameter
1	EVM (%rms)
2	EVM Sym Time Adjust 1: Window Start, 2: Window End, 3: Center, 4: Custom
3	EVM Pk (%)
4	EVM Pk Index
5	EVM Peak Sub Car Index
6	Data EVM (%rms)
7	3GPP-defined QPSK EVM (%rms)
8	3GPP-defined 16QAM EVM (%rms)
9	3GPP-defined 64QAM EVM (%rms)
10	RS EVM (%rms)
11	RS Tx. Power (dBm)
12	OFDM Sym. Tx. Power (dBm)
13	Freq Error (Hz)
14	Sync Corr (%)
15	Sync Type 1: P-SS, 20: Ant Port 0 RS, 21: Ant Port 1 RS, 22: Ant Port 2 RS, 23: Ant Port 3 RS
16	Common Tracking Error (%rms)
17	Symbol Clock Error (ppm)
18	Time Offset (s)
19	IQ Offset (dB)
20	IQ Gain Imbalance (dB)
21	IQ Quad Error (deg)
22	IQ Timing Skew (s)

Conformance EVM
Meas Setup

Index	Result Parameter
6	Data EVM (%rms)
7	3GPP-defined QPSK EVM (%rms)
8	3GPP-defined 16QAM EVM (%rms)
9	3GPP-defined 64QAM EVM (%rms)
10	RS EVM (%rms)
11	RS Tx. Power (dBm) Always returns -999.0.
12	OFDM Sym. Tx. Power (dBm) Always returns -999.0.
13	Freq Error (Hz)
14	Sync Corr (%)
15	Sync Type 2: PUSCH-DMRS, 3: PUCCH-DMRS, 4: SRS, 5: PRACH
16	Common Tracking Error (%rms)
17	Symbol Clock Error (ppm)
18	Time Offset (s)
19	IQ Offset (dB)
20	IQ Gain Imbalance (dB)
21	IQ Quad Error (deg)
22	IQ Timing Skew (s)
23	CP Length Mode 1: Normal, 2: Extended

Key Path	SCPI only
Mode	LTE, LTETDD
Remote Command	[:SENSE]:CEVM:ULINK:RESult ON OFF 0 1,... [:SENSE]:CEVM:ULINK:RESult?
Example	CEVM:ULIN:RES 1,0,0 CEVM:ULIN:RES?
Notes	Refer to the above table to see the mapping of the index and result parameter. The array length might be expanded for future enhancement.

Mode

See “[Mode](#)” on page 1534 for details.

Key Path	Front-panel key
----------	-----------------

Mode Setup

See “Mode Setup” on page 1553 for details.

Key Path	Front-panel key
----------	-----------------

Peak Search

There is no Peak Search functionality implemented in this measurement.

Key Path	Front-panel key
----------	-----------------

Recall

See “Recall” on page 194 for details.

Key Path	Front-panel key
----------	-----------------

Restart

See “Restart” on page 1558 for details.

Key Path	Front-panel key
----------	-----------------

Save

See [“Save” on page 207](#) for details.

Key Path	Front-panel key
----------	-----------------

Single

See “[Single \(Single Measurement/Sweep\)](#)” on page 1563 for details.

Key Path	Front-panel key
----------	------------------------

Source

See [“Source” on page 1564](#) for details.

Key Path	Front-panel key
----------	-----------------

SPAN X Scale

There is no Span X Scale functionality implemented for this measurement.

Key Path	Front-panel key
----------	------------------------

Sweep/Control

There is no Sweep/Control functionality implemented in this measurement.

Key Path	Front-panel key
----------	-----------------

Trace/Detector

There is no Trace/Detector functionality implemented for this measurement.

Key Path	Front-panel key
----------	-----------------

Trigger

Operation of this key is identical across several measurements. For details about this key, see [“Trigger” on page 1595](#).

Key Path	Front-panel key
----------	-----------------

View/Display

Allows you to select the desired measurement view from the following selections:

- MLISt – “Measurement List view” on page 1372
- PARAmeter – “Parameter List view” on page 1373
- RESult - “Result Metrics view” on page 1374
- RFENvelope - “RF Envelope view” on page 1375

Key Path	View/Display
Mode	LTE,LTETDD
Remote Command	:DISPlay:CEVM:VIEW[:SElect] MLISt PARAmeter RESult RFENvelope :DISPlay:CEVM:VIEW[:SElect]?
Example	DISP:CEVM:VIEW RES DISP:CEVM:VIEW?
Preset	RESult
State Saved	Saved in instrument state.
Range	Measurement List Parameter List Result Metrics RF Envelope
Initial S/W Revision	A.06.30

Display

See “Display” on page 1646 for more information.

Measurement List view

By default, this view shows the current status of enabled measurements and results.

When “Show All Items” parameter is enabled from the soft key, all available measurements and items are displayed. The measurement name and items which belong to the unavailable measurements are grayed out.

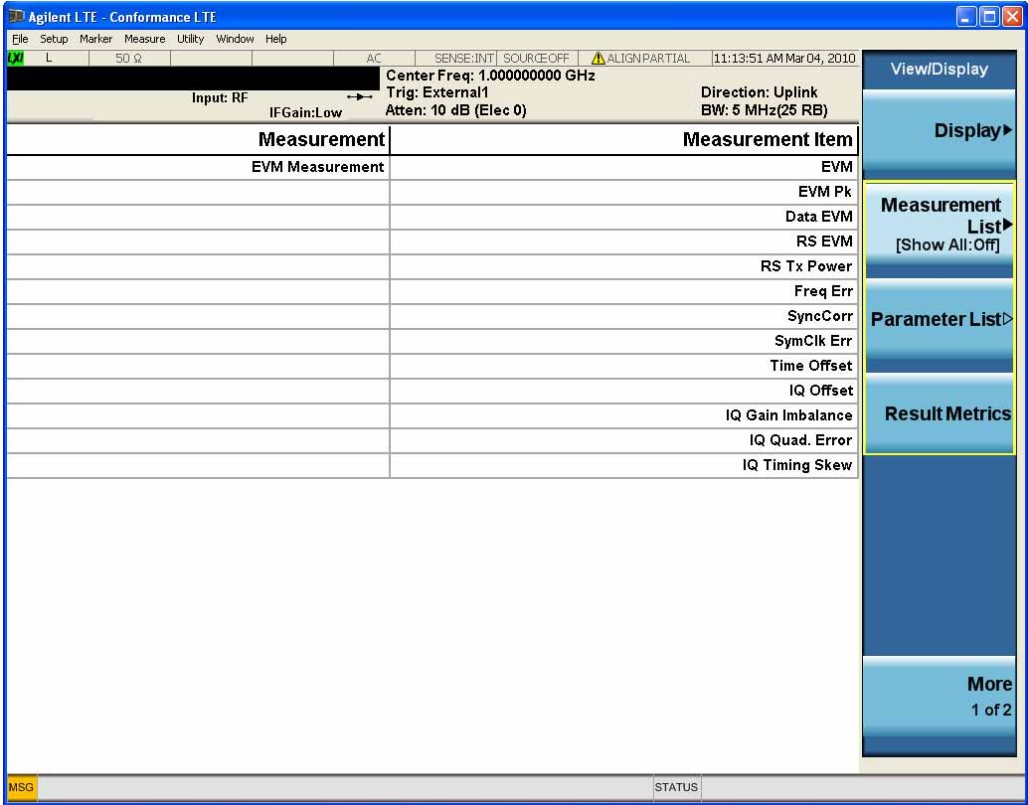

Key Path	View/Display
Initial S/W Revision	A.06.30

Show All Items

When “Show All Items” is enabled, all available measurements and items are displayed. The measurement name and items which belong to the unavailable measurements are grayed out.

Key Path	View/Display, Measurement List
Initial S/W Revision	A.06.30

Parameter List view

This view shows name, remote command and value of available commands for this measurement. You can verify and change values by using the menu, the front panel keys or by using a mouse and keyboard.

Conformance EVM
View/Display

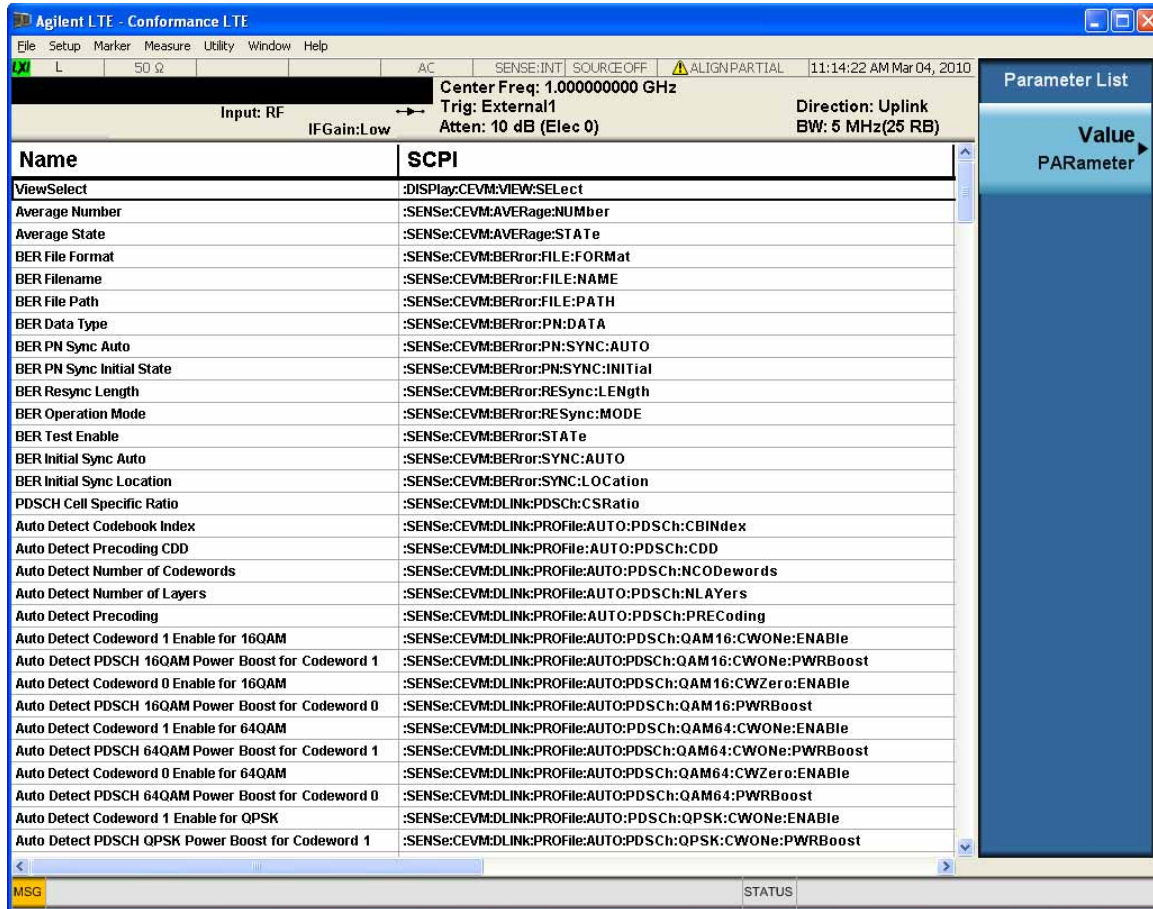

Key Path	View/Display
Initial S/W Revision	A.06.30

Value

Allows you to refer to and modify the value on the selected row.

Key Path	View/Display, Parameter List
Initial S/W Revision	A.06.30

Result Metrics view

This view shows measurement results in the same order as the remote command measurement results returned when index (n=1) is sent.



Key Path	View/Display
Initial S/W Revision	A.06.30

RF Envelope view

For diagnostic purposes, the RF Envelope view shows a time-domain magnitude plot of each frequency.

Conformance EVM
View/Display

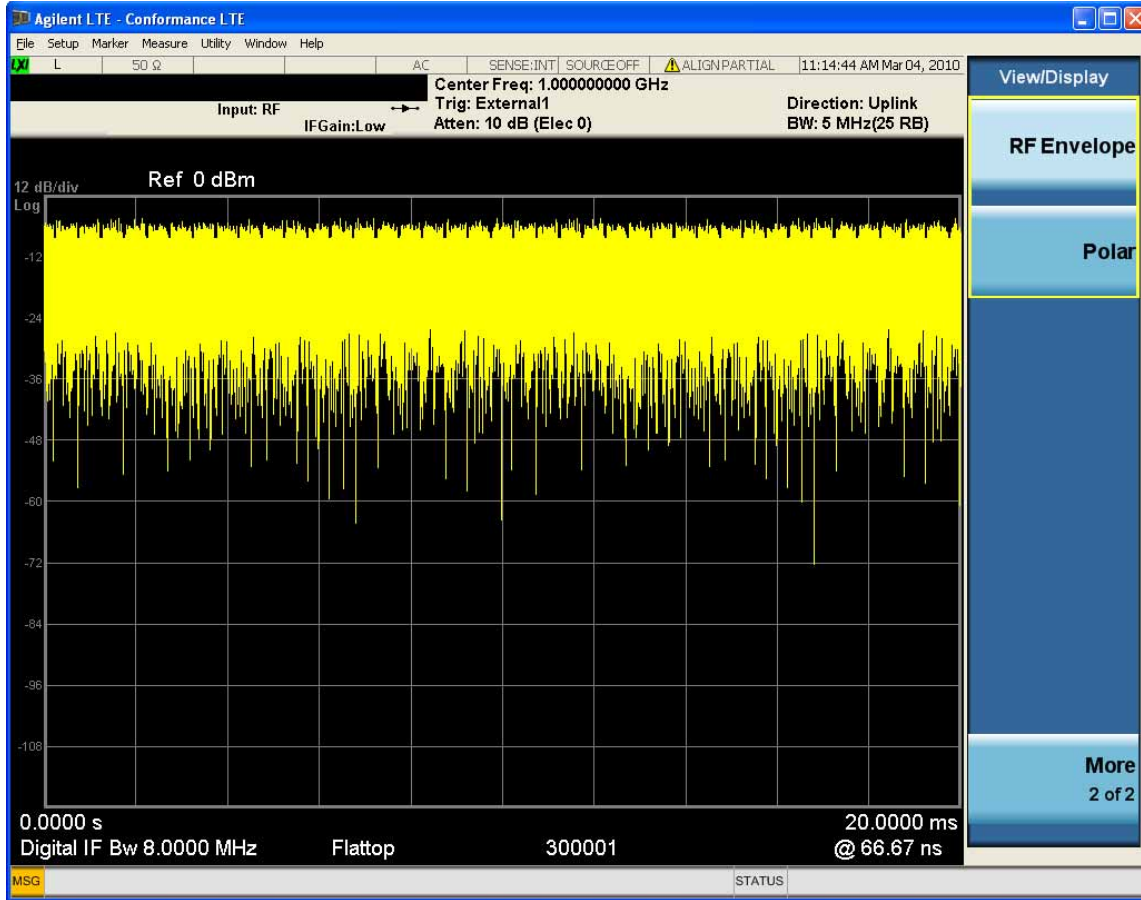

Key Path	View/Display
Initial S/W Revision	A.06.30

The key and command descriptions in this section describe functions that operate the same in multiple measurements and/or modes. This section is a library of functions that is referenced by many measurements and modes

To find the exact description and parameters for functions in a specific measurement, always look in the measurement section of this documentation. Pressing the front-panel key or softkey and then pressing the green Help key also provides the correct information.

NOTE

If you want to print the documentation, be sure to select this section and the measurement of interest to ensure having all the information you need. See [“Printing Acrobat Files” on page 141](#) for further instructions about printing.

Common Measurement Functions 1

The key and command descriptions in this section describe functions that operate identically in multiple measurements and/or modes. This section is a library of functions that is referenced by many measurements and modes.

To find the exact description and parameters for functions in a specific measurement, always look in the measurement section of this documentation. Pressing the front-panel key or softkey and then pressing the green Help key also provides the correct information.

NOTE If you want to print the documentation, be sure to select this section and the measurement of interest to ensure having all the information you need. See [“Printing Acrobat Files” on page 141](#) for further instructions about printing.

AMPTD Y Scale

The Amplitude front-panel key activates the Amplitude menu and selects Reference Level or Reference Value (depending on the measurement) as the active function.

Some features in the Amplitude menu apply to multiple measurements; others apply only to specific measurements. Keys that only apply to some measurements are blanked or grayed out in measurements in which they are not supported.

Key Path	Front-panel key
Initial S/W Revision	Prior to A.02.00

Reference Level

The Reference Level specifies the amplitude represented by the topmost graticule line.

Changing the reference level does not restart a measurement, because it is a display function only; instead it vertically ‘pans’ all displayed traces and markers to the new value. If a change to the reference level changes the attenuation value (e.g. through an auto coupling), then the measurement will be restarted.

See [“Amplitude Representations” on page 1380](#)

Key Path	AMPTD Y Scale
Remote Command	:DISPlay:WINDow[1]:TRACe:Y[:SCALE]:RLEVel <real> :DISPlay:WINDow[1]:TRACe:Y[:SCALE]:RLEVel?
Example	DISP:WIND:TRAC:Y:RLEV 20 dBm Sets the reference level to 20 dBm, which displays in the current Y axis unit. For example, if the Y axis unit is dB μ V, then 126.99 dB μ V will be displayed.

Common Measurement Functions 1

Couplings	If you reduce the attenuation, the analyzer may have to lower the reference level to keep it below its allowed maximum. This allowed maximum level is specified in the “Max” row, below, along with other variables which affect it. When you increase attenuation, the reference level does not change.
Preset	0 dBm
State Saved	Saved in instrument state
Min	$\text{RefLevelMin} = -170 \text{ dBm} + \text{RefLevelOffset} - \text{ExtGain}$.
Max	The maximum Ref Level is typically: +30 dBm + RL Offset – External Gain (for MXA and PXA) +23 dBm + RL Offset – External Gain (for EXA and CXA) This maximum value is determined by the maximum power that can be safely applied to the input circuitry. The actual maximum value at any given time may be even less than this, depending on other values including Mech Atten, Int Preamp Gain, Swept IF Gain, FFT IF Gain, Max Mixer Level, and the total attenuation currently available. Note that the maximum reference level is unaffected by the input choice of external mixing.
Default Unit	Depends on the current selected Y axis unit
Backwards Compatibility Notes	In PSA, there was a restriction on Ref Level Max which was that it could not exceed 0 dBm when the preamp was on. This restriction does not apply to X-Series. Ref Level – Ref Level is a display function, not a measurement control function, so a change in the setting does not start a new sweep (unless attenuation changes). This behavior differs from that of legacy analyzers
Initial S/W Revision	Prior to A.02.00

Amplitude Representations

The following is an illustration of the reference level and Y Axis scales under various conditions:

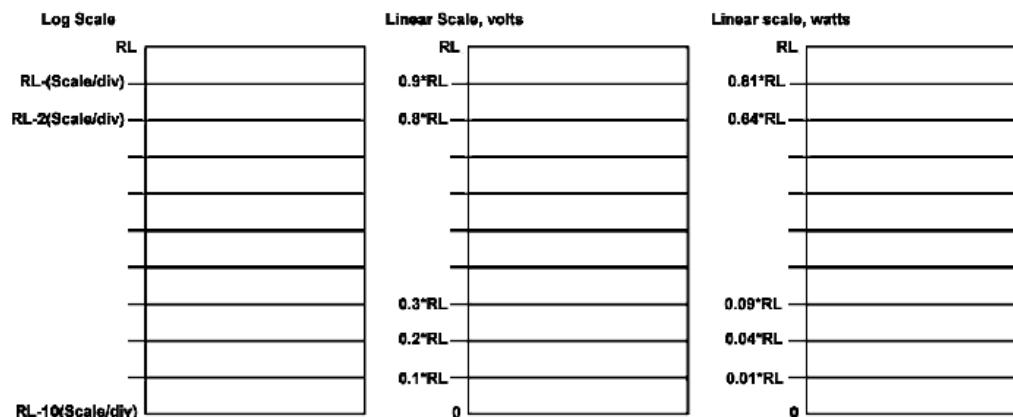

Attenuation

This menu controls the attenuator functions and interactions between the attenuation system components.

There are two attenuator configurations in the X-Series. One is a dual attenuator configuration consisting of a mechanical attenuator and an optional electronic attenuator. The other configuration uses a single attenuator with combined mechanical and electronic sections that controls all the attenuation functions. Different models in the X-Series come with different configurations.

See “Dual Attenuator Configuration:” on page 1381.

See “Single Attenuator Configuration:” on page 1381

Most Attenuation settings are the same for all measurements – they do not change as you change measurements. Settings like these are called “Meas Global” and are unaffected by Meas Preset.

Key Path	AMPTD Y Scale
Scope	Meas Global
Dependencies	In measurements which support the I/Q inputs, this key is unavailable when I/Q is the selected input, and is replaced by the Range key in that case.
Readback Line	Contains a summary in [] brackets of the current total attenuation. See the descriptions of the “(Mech) Atten ” on page 1382, “Enable Elec Atten” on page 1384, and “Elec Atten” on page 1387 keys for more detail on the contributors to the total attenuation. Note that when "Pre-Adjust for Min Clip" is on, this value can change at the start of every measurement.
Initial S/W Revision	Prior to A.02.00
Modified at S/W Revision	A.03.00

Dual Attenuator Configuration:

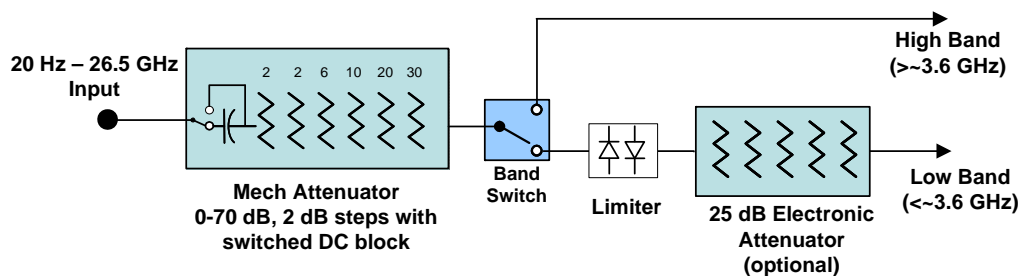

Single Attenuator Configuration:

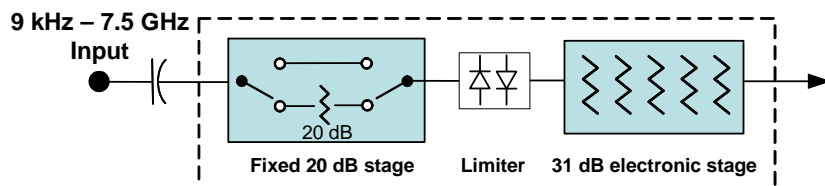

Common Measurement Functions 1

You can tell which attenuator configuration you have by pressing the Attenuation key, which (in most Modes) opens up the Attenuation menu. If the first key in the Attenuation menu says **Mech Atten** you have the dual attenuator configuration. If the first key says **Atten** you have the single attenuator configuration.

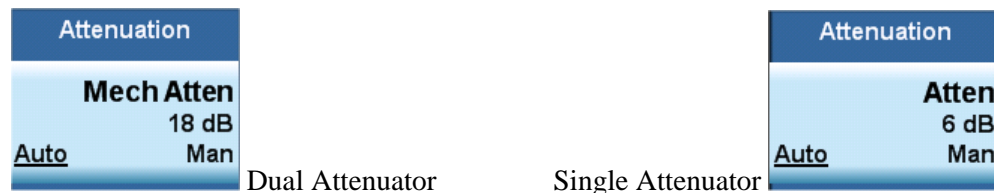

In the single attenuator configuration, you control the attenuation with a single control, as the fixed stage has only two states. In the dual attenuator configuration, both stages have significant range so you are given separate control of the mechanical and electronic attenuator stages.

When you have the dual attenuator configuration, you may still have only a single attenuator, because unless you purchase the Electronic Attenuator option you will only have the mechanical attenuator.

(Mech) Atten

This key is labeled **Mech Atten** in dual attenuator models and **Atten** in single attenuator models. In the dual attenuator configuration, this key only affects the mechanical attenuator.

This key lets you modify the attenuation applied to the RF input signal path. This value is normally auto coupled to the Ref Level, the Internal Preamp Gain, any External Gain that is entered, and the Max Mixer Level, as described in the table below.

See [“Attenuator Configurations and Auto/Man” on page 1384](#)

Key Path	AMPTD Y Scale, Attenuation
Remote Command	<pre>[:SENSe]:POWer[:RF]:ATTenuation <rel_amp1> [:SENSe]:POWer[:RF]:ATTenuation? [:SENSe]:POWer[:RF]:ATTenuation:AUTO OFF ON 0 1 [:SENSe]:POWer[:RF]:ATTenuation:AUTO?</pre>
Example	<p>POW:ATT 20</p> <p>Dual attenuator configuration: sets the mechanical attenuator to 20 dB</p> <p>Single attenuator mode: sets the main attenuation to 20 dB (see below for definition of “main” attenuation).</p> <p>If the attenuator was in Auto, it sets it to Manual.</p>

<p>Dependencies</p>	<p>Some measurements do not support the Auto setting of (Mech) Atten. In these measurements, the Auto/Man selection is not available, and the Auto/Man line on the key disappears.</p> <p>In dual attenuator configurations, when the electronic attenuator is enabled, the mechanical attenuator has no auto setting and the Auto/Man line on the key disappears. The state of Auto/Man is remembered and restored when the electronic attenuator is once again disabled. This is described in more detail in the “Enable Elec Atten” on page 1384 key description.</p> <p>See “Attenuator Configurations and Auto/Man” on page 1384 for more information on the Auto/Man functionality of Attenuation.</p>
<p>Couplings</p>	<p>When (Mech) Atten is in Auto, it uses the following algorithm to determine a value:</p> $\text{Atten} = \text{ReferenceLevel} + \text{PreAmpGain} + \text{ExternalGain} - \text{RefLevelOffset} - \text{MaxMixerLevel} + \text{IF Gain}.$ <p>Limit this value to be between 6 dB and the Max value. No value below 6 dB can ever be chosen by Auto.</p> <p>The resulting value is rounded up to the largest value possible given the attenuation step setting. That is, 50.01 dB would change to 60 dB (for a 10 dB attenuation step).</p> <p>The “IF Gain” term in the equation above is either 0 dB or +10 dB, depending on the settings of FFT IF Gain, Swept IF Gain, max Ref Level and the Auto/Man setting of Mech Atten.</p> <p>In External Mixing and BBIQ, where the Attenuator is not in the signal path, the Attenuator setting changes as described above when (Mech) Atten is in Auto, but no changes are made to the actual attenuator hardware setting until the input is changed back to the RF Input.</p>
<p>Preset</p>	<p>The preset for Mech Attenuation is “Auto.”</p> <p>The Auto value of attenuation is: CXA, EXA, MXA and PXA: 10 dB</p>
<p>State Saved</p>	<p>Saved in instrument state</p>
<p>Min</p>	<p>0 dB</p> <p>The attenuation set by this key cannot be decreased below 6 dB with the knob or step keys. To get to a value below 6 dB it has to be directly entered from the keypad or via SCPI. This protects from adjusting the attenuation to a dangerously small value which can put the instrument at risk of damage to input circuitry. However, if the current mechanical attenuation is below 6 dB it can be increased with the knob and step keys, but not decreased.</p>

Common Measurement Functions 1

Max	CXA: 50 dB EXA: 60 dB MXA and PXA: 70 dB In the single attenuator configuration, the total of ATT and EATT cannot exceed 50 dB, so if the EATT is set to 24 dB first, the main attenuation cannot be greater than 26 dB and will be reduced accordingly; if the main attenuator is set to 40 dB first, EATT cannot be greater than 10 dB.
Initial S/W Revision	Prior to A.02.00
Modified at S/W Revision	A.03.00

Attenuator Configurations and Auto/Man

As described in the Attenuation key description, there are two distinct attenuator configurations available in the X-Series, the single attenuator and dual attenuator configurations. In dual attenuator configurations, we have the mechanical attenuation and the electronic attenuation, and the current total attenuation is the sum of the electronic + mechanical attenuation. In single attenuator configurations, we refer to the attenuation set using the **(Mech) Atten** key (or POW:ATT SCPI) as the “main” attenuation; and the attenuation that is set by the SCPI command POW:EATT as the “soft” attenuation (the POW:EATT command is honored even in the single attenuator configuration, for compatibility purposes). Then the current total attenuation is the sum of the main + soft attenuation. See the **Elec Atten** key description for more on “soft” attenuation.

In the dual attenuator configuration, when the electronic attenuator is enabled, there is no Auto/Man functionality for the mechanical attenuator, and the third line of the key label (the Auto/Man line) disappears:

Mech Atten
0 dB
Auto Man

Mech Atten
0 dB

Mech Atten when elec atten disabled
--

Mech Atten when elec atten enabled

vsd05

Enable Elec Atten

Enables the Electronic Attenuator in dual attenuator configurations. This key does not appear in single attenuator configurations, as in the single attenuator configuration there is no “electronic attenuator” there is only a single integrated attenuator (which has both a mechanical and electronic stage).

The electronic attenuator offers finer steps than the mechanical attenuator, has no acoustical noise, is faster, and is less subject to wear. These advantages primarily aid in remote operation and are negligible for front panel use. See [“Using the Electronic Attenuator: Pros and Cons” on page 1386](#) for a detailed discussion of the pros and cons of using the electronic attenuator.

For the single attenuator configuration, for SCPI backwards compatibility, the “soft” attenuation feature replaces the dual attenuator configuration’s electronic attenuator. All the same couplings and limitations apply. See [“Attenuator Configurations and Auto/Man” on page 1384](#)

See “More Information” on page 1385

Key Path	AMPTD Y Scale, Attenuation
Remote Command	[:SENSe]:POWer[:RF]:EATTenuation:STATe OFF ON 0 1 [:SENSe]:POWer[:RF]:EATTenuation:STATe?
Example	POW:EATT:STAT ON
Dependencies	<p>This key only appears in the dual attenuator configuration. However, in the single attenuator configuration, EATT SCPI commands are accepted for compatibility with other X-series instruments and set a “soft” attenuation as described in “Attenuator Configurations and Auto/Man” on page 1384</p> <p>The electronic attenuator (and the “soft” attenuation function provided in single attenuator configurations) is unavailable above 3.6 GHz. Therefore, if the Stop Frequency of the analyzer is > 3.6 GHz then the Enable Elec Atten key will be OFF and grayed out.</p> <p>If the Internal Preamp is on, meaning it is set to Low Band or Full, the electronic attenuator (and the “soft” attenuation function provided in single attenuator configurations) is unavailable. In this case the Enable Elec Atten key will be OFF and grayed out.</p> <p>If either of the above is true, if the SCPI command is sent, an error indicating that the electronic attenuator is unavailable will be sent.</p> <p>If the electronic/soft Attenuator is enabled, then the Stop Freq of the analyzer is limited to 3.6 GHz and the Internal Preamp is unavailable.</p> <p>The SCPI-only “soft” electronic attenuation for the single-attenuator configuration is not available in all measurements; in particular, it is not available in the Swept SA measurement.</p>
Couplings	Enabling and disabling the Electronic Attenuator affects the setting of the Mechanical Attenuator (in dual attenuator configurations). This is described in more detail below this table.
Preset	OFF for Swept SA measurement; ON for all other measurements that support the electronic attenuator
State Saved	Saved in instrument state
Initial S/W Revision	Prior to A.02.00
Modified at S/W Revision	A.03.00

More Information

When the Electronic Attenuator is enabled, the Mechanical Attenuator transitions to a state in which it has no Auto function. Here are the rules for transitioning the Mechanical Attenuator:

When the Electronic Attenuation is enabled:

- In the dual attenuator configuration, the Mechanical Attenuator is initialized to 10 dB (this is its optimal performance setting). You can then set it as desired with SCPI, numeric keypad, step keys, or knob, and it behaves as it normally would in manual mode

Common Measurement Functions 1

- The Auto/Man state of (Mech) Atten is saved
- The Auto/Man line on the (Mech) Atten key disappears and the auto rules are disabled
- In the dual attenuator configuration, the Electronic Attenuator is set to 10 dB less than the previous value of the Mechanical Attenuator, within the limitation that it must stay within the range of 0 to 24 dB of attenuation.

Examples in the dual attenuator configuration:

- Mech Atten at 20 dB. Elec Atten enabled, Mech Atten set to 10 dB, and Elec Atten set to 10 dB. New total attenuation equals the value before Elec Atten enabled.
- Mech Atten at 0 dB. Elec Atten enabled, Mech Atten set to 10 dB, and Elec Atten set to 0 dB. New total attenuation does not equal the value before Elec Atten enabled.
- Mech Atten at 40 dB. Elec Atten enabled, Mech Atten set to 10 dB, and Elec Atten set to 24 dB. New total attenuation does not equal the value before Elec Atten enabled.

When the Electronic Attenuation is disabled:

- In the dual attenuator configuration, the Elec Atten key is grayed out (it never displays in the single attenuator configuration)
- The Auto/Man state of (Mech) Atten is restored
- If now in Auto, (Mech) Atten recouples
- If now in Man, (Mech) Atten is set to the value of total attenuation that existed before the Elec Atten was disabled. The resulting value is rounded up to the smallest value possible given the (Mech) Atten Step setting - (That is, 57 dB changes to 58 dB when (Mech) Atten Step is 2 dB.)

Using the Electronic Attenuator: Pros and Cons

The electronic attenuator offers finer steps than the mechanical attenuator, has no acoustical noise, is faster, and is less subject to wear.

The “finer steps” advantage of the electronic attenuator is beneficial in optimizing the alignment of the analyzer dynamic range to the signal power in the front panel as well as remote use. Thus, you can achieve improved relative signal measurement accuracy. Compared to a mechanical attenuator with 2 dB steps, the 1 dB resolution of the electronic attenuator only gives better resolution when the odd-decibel steps are used. Those odd-decibel steps are less accurately calibrated than the even-decibel steps, so one tradeoff for this superior relative accuracy is reduced absolute amplitude accuracy.

Another disadvantage of the electronic attenuator is that the spectrum analyzer loses its “Auto” setting, making operation less convenient.

Also, the relationship between the dynamic range specifications (TOI, SHI, compression and noise) and instrument performance are less well-known with the electrical attenuator. With the mechanical attenuator, TOI, SHI and compression threshold levels increase dB-for-dB with increasing attenuation, and the noise floor does as well. With the electronic attenuator, there is an excess attenuation of about 1 to 3 dB between 0 and 3.6 GHz, making the effective TOI, SHI, and so forth, less well known. Excess attenuation is the actual attenuation relative to stated attenuation. Excess attenuation is accounted for in the analyzer calibration

Elec Atten

Controls the Electronic Attenuator in dual attenuator configurations. This key does not appear in single attenuator configurations, as the control of both the mechanical and electronic stages of the single attenuator is integrated into the single **Atten** key.

Key Path	AMPTD Y Scale, Attenuation
Remote Command	[:SENSe]:POWer[:RF]:EATTenuation <rel_ampl> [:SENSe]:POWer[:RF]:EATTenuation?
Notes	Electronic Attenuation's spec is defined only when Mechanical Attenuation is 6 dB.
Dependencies	This key only appears in the dual attenuator configuration. However, in the single attenuator configuration, EATT SCPI commands are accepted for compatibility with other X-series instruments and set a "soft" attenuation as described in " Attenuator Configurations and Auto/Man " on page 1384 . The "soft" attenuation is treated as an addition to the "main" attenuation value set by the Atten softkey or the POW:ATT SCPI command and affects the total attenuation displayed on the Attenuation key and the Meas Bar. When Enable Elec Atten is off, the Elec Atten key is grayed out.
Preset	0 dB
State Saved	Saved in instrument state
Min	0 dB
Max	Dual attenuator configuration: 24 dB Single attenuator configuration: the total of ATT and EATT cannot exceed 50 dB, so if the EATT is set to 24 dB first, the main attenuation cannot be greater than 26 dB and will be reduced accordingly; if the main attenuator is set to 40 dB first, EATT cannot be greater than 10 dB
Initial S/W Revision	Prior to A.02.00
Modified at S/W Revision	A.03.00

Adjust Atten for Min Clip

Sets the combination of mechanical and electronic attenuation based on the current measured signal level so that clipping will be at a minimum.

This is an "immediate action" function, that is, it executes once, when the key is pressed.

This key is grayed out in measurements that do not support this functionality. The spectrum analyzer measurement, Swept SA, does not support this functionality.

Key Path	AMPTD Y Scale, Attenuation
Remote Command	[:SENSe]:POWer[:RF]:RANGe:OPTimize IMMEDIATE
Initial S/W Revision	Prior to A.02.00

Common Measurement Functions 1

Modified at S/W Revision	A.03.00
--------------------------	---------

Pre-Adjust for Min Clip

If this function is on, it does the adjustment described under [“Adjust Atten for Min Clip” on page 1387](#) each time a measurement restarts. Therefore, in Continuous measurement mode, it only executes before the first measurement.

In dual attenuator models, you can set **Elec+Mech Atten**, in which case both attenuators participate in the autoranging, or **Elec Atten Only**, in which case the mechanical attenuator does not participate in the autoranging. This latter case results in less wear on the mechanical attenuator and is usually faster.

This key is grayed out in measurements that do not support this functionality. The spectrum analyzer measurement, Swept SA, does not support this functionality.

Key Path	AMPTD Y Scale, Attenuation
Remote Command	[:SENSe]:POWer[:RF]:RANGe:OPTimize:ATTenuation OFF ELECTrical COMBined [:SENSe]:POWer[:RF]:RANGe:OPTimize:ATTenuation?
Notes	The SCPI parameter ELECTrical sets this function to On in single attenuator models. The SCPI parameter COMBined is mapped to ELECTrical in single attenuator models; if you send COMBined, it sets the function to On and returns ELEC to a query.
Preset	OFF for Swept SA measurement; ON for all other measurements that support Pre-Adjust for Min Clip
State Saved	Saved in instrument state
Range	Dual attenuator models: Off Elec Atten Only Mech + Elec Atten Single attenuator models: Off On
Initial S/W Revision	Prior to A.02.00
Modified at S/W Revision	A.03.00

Remote Command	[:SENSe]:POWer[:RF]:RANGe:AUTO ON OFF 1 0 [:SENSe]:POWer[:RF]:RANGe:AUTO?
Notes	ON aliases to "Elec Atten Only" (:POW:RANG:OPT:ATT ELEC) OFF aliases to "Off" (:POW:RANG:OPT:ATT OFF) The query :POW:RANG:AUTO? returns true if :POW:RANG:OPT:ATT is not "Off"
Initial S/W Revision	Prior to A.02.00

(Mech) Atten Step

This controls the step size used when making adjustments to the input attenuation.

This key is labeled **Mech Atten Step** in dual attenuator models and **Atten Step** in single attenuator models. In the dual attenuator configuration, this key only affects the step size of the mechanical attenuator.

Key Path	AMPTD Y Scale, Attenuation
Remote Command	[:SENSE] :POWER [:RF] :ATTenuation :STEP [:INCRement] 10 dB 2 dB [:SENSE] :POWER [:RF] :ATTenuation :STEP [:INCRement] ?
Example	POW:ATT:STEP 2
Notes	This feature works like a 1-N choice from the front panel, but it takes a specific value (in dB) when used remotely. The only valid values are 2 and 10.
Dependencies	Blanked in CXA and EXA if option FSA (2 dB steps) is not present. If blanked, attempts to set it via SCPI will yield an error.
Couplings	When the attenuation step size changes, the current mechanical attenuation value is adjusted (if necessary) to be quantized to the new step size. That is, if step is set to 10 dB, mech atten is increased if necessary so it is a multiple of 10 dB
Preset	PXA and MXA: 2 dB EXA and CXA: 10 dB (2 dB with option FSA)
State Saved	Saved in instrument state
Initial S/W Revision	Prior to A.02.00
Modified at S/W Revision	A.03.00

Max Mixer Level

Controls the limitation on the Ref Level for a given attenuation setting, and therefore also interacts with the Auto rules for selecting the attenuation as a coupling from the reference level.

Key Path	AMPTD Y Scale, Attenuation
Remote Command	[:SENSE] :POWER [:RF] :MIXer :RANGe [:UPPer] <real> [:SENSE] :POWER [:RF] :MIXer :RANGe [:UPPer] ?
Example	POW:MIX:RANG -15 dBm
Preset	-10 dBm
State Saved	Saved in instrument state
Min	-50 dBm
Max	-10 dBm

Common Measurement Functions 1

Default Unit	Depends on the current selected Y axis unit, see Swept SA discussion of Y Axis Unit
Initial S/W Revision	Prior to A.02.00

Range

This key is only available when I/Q is the selected input. It replaces the Attenuation key in that case.

Each input channel (I and Q) has four internal gain ranges. The maximum allowed voltage in each gain range is slightly more than the nominal value, so the break point between ranges is a couple of millivolts higher than the nominal (setting a peak voltage of 0.502 mV will still map to the 0.5 V Peak range).

Gain Setting	Volts RMS	Volts Peak	Volts Peak - Peak	dBm (50W)	Break Point
0 dB	0.7071	1.0	2.0	10	n/a
6 dB	0.3536	0.5	1.0	4	0.502 V Peak
12 dB	0.1768	0.25	0.5	-2	0.252 V Peak
18 dB	0.0884	0.125	0.25	-8	0.127 V Peak

Key Path	AMPTD Y Scale
Notes	Visible only when the selected input is I/Q.
State Saved	No
Readback Text	When Range is Auto, "[Auto]" When Range is Man and I & Q are the same, "[<range value>]" When Range is Man and I & Q are different: "[I: <I range value> Q: <Q range value>]" See I Range and Q Range for the <range value> enumeration definition.
Initial S/W Revision	Prior to A.02.00

Range Auto/Man

The Auto setting for Range causes the range to be set based on the Y Scale settings. When Range is "Auto", the I & Q Range are set based on the top of the Y Scale when the Y scale is in dB units (for example, power), or to the max(abs(top), abs(bottom)) when the Y scale reference is not at the top of the screen.

Not all measurements support Range Auto/Man. If Auto is not supported in the current measurement, this key is grayed out and shows "Man" and MAN is returned to a SCPI query; but this does NOT change the Auto/Man setting for Range. When you go to a measurement that supports Auto, it goes back to Auto if it was previously in Auto mode.

Key Path	AMPTD Y Scale, Range
----------	-----------------------------

Scope	Meas Global
Remote Command	[:SENSE] :VOLTage : IQ :RANGe :AUTO OFF ON 0 1 [:SENSE] :VOLTage : IQ :RANGe :AUTO ?
Example	Put the I Range and Q Range in manual. VOLT:IQ:RANG:AUTO OFF
Dependencies	If Auto is not supported, sending the SCPI command will generate an error.
Couplings	When in Auto, both I Range and Q Range are set to the same value, computed as follows: Maximum absolute value is computed for the Y Scale. The top and bottom of the graph are computed based on Ref Value, Scale/Div, and Ref Position. Formula: YMax = max(abs(top), abs(bottom)). The I Range and Q Range are then set to YMax.
Preset	ON
State Saved	Saved in instrument state
Range	Auto Man
Initial S/W Revision	Prior to A.02.00

Remote Command	[:SENSE] :POWER : IQ :RANGe :AUTO OFF ON 0 1 [:SENSE] :POWER : IQ :RANGe :AUTO ?
Example	Put the I Range and Q Range in manual. POW:IQ:RANG:AUTO OFF
Notes	The POW:IQ:RANG:AUTO is an alternate form of the VOLT:IQ:RANG:AUTO command. This is to maintain consistency with I Range and Q Range, which support both the POWER and VOLTage forms of the command.
Preset	ON
Range	Auto Man
Initial S/W Revision	Prior to A.02.00

I Range

This is the internal gain range for the I channel when Input Path is I Only or Ind I/Q, and it is used for both the I and Q channels when the Input Path is I+jQ. See [“I/Q Gain Ranges” on page 1395](#).

Key Path	AMPTD Y Scale, Range
Remote Command	[:SENSE] :VOLTage : IQ [: I] :RANGe [:UPPer] <voltage> [:SENSE] :VOLTage : IQ [: I] :RANGe [:UPPer] ?

Common Measurement Functions 1

Example	Set the I Range to 0.5 V Peak VOLT:IQ:RANG 0.5 V
Notes	The numeric entries are mapped to the smallest gain range whose break point is greater than or equal to the value, or 1 V Peak if the value is greater than 1 V.
Couplings	When Q Same as I is On, the I Range value will be copied to the Q Range. Changing the value will also set Range = Man.
Preset	1 V Peak
State Saved	Saved in instrument state
Range	1 V Peak 0.5 V Peak 0.25 V Peak 0.125 V Peak
Initial S/W Revision	Prior to A.02.00

Remote Command	[:SENSE]:POWER:IQ[:I]:RANGE[:UPPER] <ampl> [:SENSE]:POWER:IQ[:I]:RANGE[:UPPER]?
Example	Set the I Range to 0.5 V Peak when Reference Z is 50Ω, and to 1.0 V Peak when Reference Z is 75Ω POW:IQ:RANG 4 dBm
Notes	The POWER form of the command is provided for convenience. It maps to the same underlying gain range parameter as the VOLTage form of the command. The Reference Z (not the I channel Input Z) is used to convert the power to peak voltage, which is then used to set the I Range as with the VOLTage form of the command. The power values of the 4 range states (1V Peak, 0.5V Peak, 0.25V Peak, and 0.125V Peak) will vary with Reference Z. Here are some examples: 50Ω: 10, 4, -2, -8 75Ω: 8.2, 2.2, -3.8, -9.8 600Ω: -0.8, -6.8, -12.8, -18.9
Preset	10.0 dBm
Range	-20 dBm to 10 dBm
Min	-20 dBm
Max	10 dBm
Initial S/W Revision	Prior to A.02.00

Q Range

Accesses the Q Range menu.

Key Path	AMPTD Y Scale, Range
----------	-----------------------------

Readback Text	Q Same as I 1 V Peak 0.5 V Peak 0.25 V Peak 0.125 V Peak When Q Same as I is On, the readback is "Q Same as I", otherwise it is the Q Range value.
Initial S/W Revision	Prior to A.02.00

Q Same as I

Many, but not all, usages require the I and Q channels to have an identical setup. To simplify channel setup, the Q Same as I will cause the Q channel range to be mirrored from the I channel. That way you only need to set up one channel (the I channel). The I channel values are copied to the Q channel, so at the time Q Same as I is Off, the I and Q channel setups will be identical.

Key Path	AMPTD Y Scale, Range, Q Range
Remote Command	[:SENSe] :VOLtagE POWer : IQ : MIRRored OFF ON 0 1 [:SENSe] :VOLtagE POWer : IQ : MIRRored ?
Example	Turn off the mirroring of I Range to Q Range. VOLT:IQ:MIRR OFF POW:IQ:MIRR OFF
Couplings	When On, the I Range value is mirrored (copied) to the Q Range.
Preset	On
State Saved	Saved in instrument state.
Range	On Off
Readback Text	"Q Same as I" when On, otherwise none.
Initial S/W Revision	Prior to A.02.00

Q Range Value

This is the internal gain range for the Q channel. See [“I/Q Gain Ranges” on page 1395](#)

. The Q Range only applies to Input Path Q Only and Ind I/Q. For input I+jQ the I Range determines both I and Q channel range settings.

Key Path	AMPTD Y Scale, Range
Remote Command	[:SENSe] :VOLtagE : IQ : Q : RANGe [:UPPer] <voltage> [:SENSe] :VOLtagE : IQ : Q : RANGe [:UPPer] ?
Example	Set the Q Range to 0.5 V Peak VOLT:IQ:Q:RANG 0.5 V

Common Measurement Functions 1

Notes	<p>The numeric entries are mapped to the smallest gain range whose break point is greater than or equal to the value, or 1 V Peak if the value is greater than 1 V.</p> <p>The Q Range is only used for Input Path Q Only and Ind I/Q. For input I+jQ the I Range determines both I and Q channel range settings.</p>
Couplings	<p>When Q Same as I is On, the I Range value will be copied to the Q Range and the range value keys are disabled.</p> <p>Changing the value will also set Range = Man.</p>
Preset	1 V Peak
State Saved	Saved in instrument state
Range	1 V Peak 0.5 V Peak 0.25 V Peak 0.125 V Peak
Initial S/W Revision	Prior to A.02.00

Remote Command	<pre>[:SENSe]:POWER:IQ:Q:RANGe[:UPPer] <ampl></pre> <pre>[:SENSe]:POWER:IQ:Q:RANGe[:UPPer]?</pre>
Example	<p>Will set the Q Range to 0.5 V Peak when Reference Z is 50Ω, and to 1.0 V Peak when Reference Z is 75Ω</p> <p>POW:IQ:Q:RANG 4 dBm</p>
Notes	<p>The POWER form of the command is provided for convenience. It maps to the same underlying gain range parameter as the VOLTage form of the command.</p> <p>The Reference Z (not the Q channel Input Z) is used to convert the power to peak voltage, which is then used to set the Q Range as with the VOLTage form of the command. The power values of the 4 range states (1V Peak, 0.5V Peak, 0.25V Peak, and 0.125V Peak) will vary with Reference Z. Here are some examples:</p> <p>50Ω: 10, 4, -2, -8 75Ω: 8.2, 2.2, -3.8, -9.8 600Ω: -0.8, -6.8, -12.8, -18.9</p>
Preset	10.0 dBm
Range	-20 dBm to 10 dBm
Min	-20 dBm
Max	10 dBm
Initial S/W Revision	Prior to A.02.00

I/Q Gain Ranges

1 V Peak

Set the channel gain state to 1 Volt Peak.

Key Path	AMPTD Y Scale, I Range Q Range
Initial S/W Revision	Prior to A.02.00

0.5 V Peak

Set the channel gain state to 0.5 Volt Peak.

Key Path	AMPTD Y Scale, I Range Q Range
Initial S/W Revision	Prior to A.02.00

0.25 V Peak

Set the channel gain state to 0.25 Volt Peak.

Key Path	AMPTD Y Scale, I Range Q Range
Initial S/W Revision	Prior to A.02.00

0.125 V Peak

Set the channel gain state to 0.125 Volt Peak.

Key Path	AMPTD Y Scale, I Range Q Range
Initial S/W Revision	Prior to A.02.00

Scale / Div

Sets the units per vertical graticule division on the display. This function is only available when Scale Type (Log) is selected and the vertical scale is power. When Scale Type (Lin) is selected, Scale/Div is grayed out.

Key Path	AMPTD Y Scale
Remote Command	:DISPlay:WINDow[1]:TRACe:Y[:SCALe]:PDIVision <rel_ampl> :DISPlay:WINDow[1]:TRACe:Y[:SCALe]:PDIVision?
Example	DISP:WIND:TRAC:Y:PDIV 5 DB
Dependencies	Scale/Div is grayed out in linear Y scale. Sending the equivalent SCPI command does change the Scale/Div, though it has no affect while in Lin.
Preset	10.00 dB / Div
State Saved	Saved in instrument state
Min	0.10 dB

Common Measurement Functions 1

Max	20 dB
Initial S/W Revision	Prior to A.02.00

Scale Type

Chooses a linear or logarithmic vertical scale for the display and for remote data readout.

When Scale Type (Log) is selected, the vertical graticule divisions are scaled in logarithmic units. The top line of the graticule is the Reference Level and uses the scaling per division Scale/Div to assign values to the other locations on the graticule.

When Scale Type (Lin) is selected, the vertical graticule divisions are linearly scaled with the reference level value at the top of the display and zero volts at the bottom. Each vertical division of the graticule represents one-tenth of the Reference Level.

NOTE The Y Axis Unit used for each type of display is set by pressing Y Axis Unit. The analyzer remembers separate Y Axis Unit settings for both Log and Lin.

Key Path	AMPTD Y Scale
Remote Command	:DISPlay:WINDow[1]:TRACe:Y[:SCALe]:SPACing LINear LOGarithmic :DISPlay:WINDow[1]:TRACe:Y[:SCALe]:SPACing?
Example	DISP:WIND:TRAC:Y:SPAC LOG DISP:WIND:TRAC:Y:SPAC?
Dependencies	If Normalize is on, Scale Type forced to Log and is grayed out.
Couplings	Changing the Scale Type always sets the Y Axis unit to the last unit specified for the current amplitude scale. In other words, we restore the Y Axis unit setting appropriate per log/lin.
Preset	LOG
State Saved	Saved in instrument state
Initial S/W Revision	Prior to A.02.00

Presel Center

When this key is pressed, the centering of the preselector filter is adjusted to optimize the amplitude accuracy at the frequency of the selected marker. If the selected marker is not on when Presel Center is pressed, the analyzer will turn on the selected marker, perform a peak search, and then perform centering on the marker's center frequency. If the selected marker is already on and between the start and stop frequencies of the analyzer, the analyzer performs the preselector calibration on that marker's frequency. If the selected marker is already on, but outside the frequency range between Start Freq and Stop Freq, the analyzer will first perform a peak search, and then perform centering on the marker's center frequency.

The value displayed on the **Presel Adjust** key will change to reflect the new preselector tuning (see **Presel Adjust**).

A number of considerations should be observed to ensure proper operation. See [“Proper Preselector Operation” on page 1397](#).

Key Path	AMPTD Y Scale
Remote Command	[:SENSe] :POWer [:RF] :PCENter
Example	POW:PCEN
Notes	Note that the rules outlined above under the key description apply for the remote command as well as the key. The result of the command is dependent on marker position, and so forth. Any message shown by the key press is also shown in response to the remote command.
Dependencies	<ul style="list-style-type: none"> • Grayed out if the microwave preselector is off.) • If the selected marker’s frequency is below Band 1, advisory message 0.5001 is generated and no action is taken. • Grayed out if entirely in Band 0. • Blank in models that do not include a preselector, such as option 503. If the SCPI is sent in these instruments, it is accepted without error, and the query always returns 0. • Grayed out in the Spectrogram View.
Couplings	The active marker position determines where the centering will be attempted. If the analyzer is in a measurement such as averaging when centering is initiated, the act of centering the preselector will restart averaging but the first average trace will not be taken until the centering is completed.
Status Bits/OPC dependencies	When centering the preselector, *OPC will not return true until the process is complete and a subsequent measurement has completed, nor will results be returned to a READ or MEASure command. The Measuring bit should remain set while this command is operating and should not go false until the subsequent sweep/measurement has completed.
Initial S/W Revision	Prior to A.02.00
Modified at S/W Revision	A.03.00

Proper Preselector Operation

A number of considerations should be observed to ensure proper operation:

If the selected marker is off, the analyzer will turn on a marker, perform a peak search, and adjust the preselector using the selected marker’s frequency. It uses the "highest peak" peak search method unqualified by threshold or excursion, so that there is no chance of a ‘no peak found’ error. It continues with that peak, even if it is the peak of just noise. Therefore, for this operation to work properly, there should be a signal on screen in a preselected range for the peak search to find.

If the selected marker is already on, the analyzer will attempt the centering at that marker’s frequency.

Common Measurement Functions 1

There is no preselector for signals below about 3.6 GHz, therefore if the marker is on a signal below 3.6 GHz, no centering will be attempted and an advisory message generated

In some models, the preselector can be bypassed. If it is bypassed, no centering will be attempted in that range and a message will be generated.

Preselector Adjust

Allows you to manually adjust the preselector filter frequency to optimize its response to the signal of interest. This function is only available when “[Presel Center](#)” on page 1396 is available.

For general purpose signal analysis, using Presel Center is recommended. Centering the filter minimizes the impact of long-term preselector drift. Presel Adjust can be used instead to manually optimize the preselector. One application of manual optimization would be to peak the preselector response, which both optimizes the signal-to-noise ratio and minimizes amplitude variations due to small (short-term) preselector drifting.

Key Path	AMPTD Y Scale
Scope	Meas Global
Remote Command	[:SENSE]:POWER[:RF]:PADJust <freq> [:SENSE]:POWER[:RF]:PADJust?
Example	POW:PADJ 100KHz POW:PADJ?
Notes	The value on the key reads out to 0.1 MHz resolution.
Dependencies	<ul style="list-style-type: none"> • Grayed out if microwave preselector is off.) • Grayed out if entirely in Band 0. • Blank in models that do not include a preselector, such as option 503. If the SCPI is sent in these instruments, it is accepted without error, and the query always returns 0. • Grayed out in the Spectrogram View.
Preset	0 MHz
State Saved	The Presel Adjust value set by Presel Center , or by manually adjusting Presel Adjust , is not saved in Instrument State, and does not survive a Preset or power cycle.
Min	–500 MHz
Max	500 MHz
Default Unit	Hz
Backwards Compatibility SCPI	[:SENSE]:POWER[:RF]:MW:PADJust [:SENSE]:POWER[:RF]:MMW:PADJust PSA had multiple preselectors, but the X-Series has only one. These commands simply alias to [:SENSE]:POWER[:RF]:PADJust

Initial S/W Revision	Prior to A.02.00
Modified at S/W Revision	A.03.00

Remote Command	[:SENSE] :POWER [:RF] :PADJust :PRESelector MWAVE MMWave EXTERNAL [:SENSE] :POWER [:RF] :PADJust :PRESelector?
Notes	PSA had multiple preselectors, and you could select which preselector to adjust. Since the X-Series has only one mm/uW preselector, the preselector selection softkey is no longer available. However, in order to provide backward compatibility, we accept the legacy remote commands. The command form has no effect, the query always returns MWAVE
Initial S/W Revision	Prior to A.02.00

Y Axis Unit

Displays the menu keys that enable you to change the vertical (Y) axis amplitude unit. The analyzer retains the entered Y Axis Unit separately for both Log and Lin amplitude scale types. For example, if Scale Type has been set to Log, and you set Y Axis Unit to dBm, pressing Scale Type (Log) sets the Y Axis Unit to dBm. If Scale Type has been set to Lin and you set Y Axis Unit to V, pressing Scale Type (Lin) sets the Y Axis Unit to V. Pressing Scale Type (Log) again sets the Y axis unit back to dBm.

NOTE The units of current (A, dBmA, dBuA) are calculated based on 50 ohms input impedance.

 All four of the EMI units (dBμA/m, dBμV/m, dBG, dBpT) are treated by the instrument exactly as though they were dBuV. The user must load an appropriate correction factor using Amplitude Corrections for accurate and meaningful results.

 If a SCPI command is sent to the analyzer that uses one of the EMI units as a terminator, the analyzer treats it as though DBUV had been sent as the terminator.

Key Path	AMPTD Y Scale
Mode	SA
Scope	Meas Global
Remote Command	:UNIT:POWer DBM DBMV DBMA V W A DBUV DBUA DBUVM DBUAM DBPT DBG :UNIT:POWer?
Example	UNIT:POW dBmV UNIT:POW?

Common Measurement Functions 1

Notes	The Y axis unit has either logarithmic or linear characteristics. The set of units that is logarithmic consists of dBm, dBmV, dBmA, dB μ V, dB μ A, dB μ V/m, dB μ A/m, dBpT, and dBG. The set if units that is linear consists of V, W, and A. The chosen unit will determine how the reference level and all the amplitude-related outputs like trace data, marker data, etc. read out.
Notes	<p>The settings of Y Axis Unit and Scale Type, affect how the data is read over the remote interface. When using the remote interface no unit is returned, so you must know what the Y axis unit is to interpret the results:</p> <p>Example 1, set the following:</p> <p>Scale Type (Log)</p> <p>Y Axis Unit, dBm</p> <p>Scale/Div, 1 dB</p> <p>Ref Level, 10 dBm</p> <p>This sets the top line to 10 dBm with each vertical division representing 1 dB. Thus, if a point on trace 1 is on the fifth graticule line from the top, it represents 5 dBm and will read out remotely as 5.</p> <p>Example 2, set the following:</p> <p>Scale Type (Lin)</p> <p>Y Axis Unit, Volts</p> <p>Ref Level, 100 mV (10 mV/div)</p> <p>This sets the top line to 100 mV and the bottom line to 0 V, so each vertical division represents 10 mV. Thus, if a point on trace 1 is on the fifth graticule line from the top, it represents 50 mV and will read out remotely as 50.</p>
Dependencies	<p>If an amplitude correction with an Antenna Unit other than None is applied and enabled, then that antenna unit is forced and the key with that unit is the only Y Axis Unit available. All other Y Axis Unit keys are grayed out.</p> <p>If an amplitude correction with an Antenna Unit other than None is applied and enabled, and you then turn off that correction or set Apply Corrections to No, the Y Axis Unit that existed before the Antenna Unit was applied is restored.</p>
Couplings	The analyzer retains the entered Y Axis Unit separately for both Log and Lin amplitude scale types
Preset	dBm for log scale, V for linear. The true 'preset' value is dBm, since at preset the Y Scale type is set to logarithmic.
State Saved	Saved in instrument state
Readback line	1-of-N selection
Initial S/W Revision	Prior to A.02.00
Modified at S/W Revision	A.02.00, A.04.00

dBm

Sets the amplitude unit for the selected amplitude scale (log/lin) to dBm.

Key Path	AMPTD Y Scale, Y Axis Unit
Example	UNIT:POW DBM
Dependencies	Grayed out if an Amplitude Correction with an Antenna Unit is ON.
Readback	dBm
Initial S/W Revision	Prior to A.02.00
Modified at S/W Revision	A.02.00

dBmV

Sets the amplitude unit for the selected amplitude scale (log/lin) to dBmV.

Key Path	AMPTD Y Scale, Y Axis Unit
Example	UNIT:POW DBMV
Dependencies	Grayed out if an Amplitude Correction with an Antenna Unit is ON.
Readback	dBmV
Initial S/W Revision	Prior to A.02.00
Modified at S/W Revision	A.02.00

dBmA

Sets the amplitude unit for the selected amplitude scale (log/lin) to dBmA.

Key Path	AMPTD Y Scale, Y Axis Unit
Example	UNIT:POW DBMA
Dependencies	Grayed out if an Amplitude Correction with an Antenna Unit is ON.
Readback	dBmA
Initial S/W Revision	Prior to A.02.00
Modified at S/W Revision	A.02.00

W

Sets the amplitude unit for the selected amplitude scale (log/lin) to watt.

Key Path	AMPTD Y Scale, Y Axis Unit
Example	UNIT:POW W
Dependencies	Grayed out if an Amplitude Correction with an Antenna Unit is ON.

Common Measurement Functions 1

Readback	W
Initial S/W Revision	Prior to A.02.00
Modified at S/W Revision	A.02.00

V

Sets the amplitude unit for the selected amplitude scale (log/lin) to volt.

Key Path	AMPTD Y Scale, Y Axis Unit
Example	UNIT:POW V
Dependencies	Grayed out if an Amplitude Correction with an Antenna Unit is ON.
Readback	V
Initial S/W Revision	Prior to A.02.00
Modified at S/W Revision	A.02.00

A

Sets the amplitude unit for the selected amplitude scale (log/lin) to Ampere.

Key Path	AMPTD Y Scale, Y Axis Unit
Example	UNIT:POW A
Dependencies	Grayed out if an Amplitude Correction with an Antenna Unit is ON.
Readback	A
Initial S/W Revision	Prior to A.02.00
Modified at S/W Revision	A.02.00

dB μ V

Sets the amplitude unit for the selected amplitude scale (log/lin) to dB μ V.

Key Path	AMPTD Y Scale, Y Axis Unit
Example	UNIT:POW DBUV
Dependencies	Grayed out if an Amplitude Correction with an Antenna Unit is ON.
Readback	dB μ V
Initial S/W Revision	Prior to A.02.00
Modified at S/W Revision	A.02.00

dB μ A

Sets the amplitude unit for the selected amplitude scale (log/lin) to dB μ A.

Key Path	AMPTD Y Scale, Y Axis Unit
Example	UNIT:POW DBUA
Dependencies	Grayed out if an Amplitude Correction with an Antenna Unit is ON.
Readback	dB μ A
Initial S/W Revision	Prior to A.02.00
Modified at S/W Revision	A.02.00

dB μ V/m

Sets the amplitude unit for the selected amplitude scale (log/lin) to dB μ V/m. This is an antenna unit, and this key is grayed out unless a Correction with this Antenna Unit selected is ON. If this is the case, all of the other Antenna Units are grayed out.

Key Path	AMPTD Y Scale, Y Axis Unit
Example	UNIT:POW DBUVM
Dependencies	Grayed out if no Amplitude Correction with an Antenna Unit is on.
Readback	dB μ V/m
Initial S/W Revision	A.02.00

dB μ A/m

Sets the amplitude unit for the selected amplitude scale (log/lin) to dB μ A/m. This is an antenna unit, and this key is grayed out unless a Correction with this Antenna Unit selected is ON. If this is the case, all of the other Antenna Units are grayed out.

Key Path	AMPTD Y Scale, Y Axis Unit
Example	UNIT:POW DBUAM
Dependencies	Grayed out if no Amplitude Correction with an Antenna Unit is on.
Readback	dB μ A/m
Initial S/W Revision	A.02.00

dBpT

Sets the amplitude unit for the selected amplitude scale (log/lin) to dBpT. This is an antenna unit, and this key is grayed out unless a Correction with this Antenna Unit selected is ON. If this is the case, all of the other Antenna Units are grayed out.

Key Path	AMPTD Y Scale, Y Axis Unit
----------	-----------------------------------

Common Measurement Functions 1

Example	UNIT:POW DBPT
Dependencies	Grayed out if no Amplitude Correction with an Antenna Unit is on.
Readback	dBpT
Initial S/W Revision	A.02.00

dBG

Sets the amplitude unit for the selected amplitude scale (log/lin) to dBG. This is an antenna unit, and this key is grayed out unless a Correction with this Antenna Unit selected is ON. If this is the case, all of the other Antenna Units are grayed out.

Key Path	AMPTD Y Scale, Y Axis Unit
Example	UNIT:POW DBG
Dependencies	Grayed out if no Amplitude Correction with an Antenna Unit is on.
Readback	DBG
Initial S/W Revision	A.02.00

Reference Level Offset

Adds an offset value to the displayed reference level. The reference level is the absolute amplitude represented by the top graticule line on the display.

See [“More Information” on page 1405](#)

Key Path	AMPTD Y Scale
Mode	SA
Scope	Meas Global
Remote Command	:DISPlay:WINDow[1]:TRACe:Y[:SCALe]:RLEVel:OFFSet <rel_ampl> :DISPlay:WINDow[1]:TRACe:Y[:SCALe]:RLEVel:OFFSet?
Example	DISP:WIND:TRAC:Y:RLEV:OFFS 12.7 Sets the Ref Level Offset to 12.7 dB. The only valid suffix is dB. If no suffix is sent, dB will be assumed.
Preset	0 dBm
State Saved	Saved in instrument state
Min	The range for Ref Lvl Offset is variable. It is limited to values that keep the reference level within the range of -327.6 dB to 327.6 dB.
Max	327.6 dB

Backwards Compatibility Notes	In pre-X-Series instruments, Ref Level Offset could not be adjusted by the knob or step keys. That is no longer the case. In ESA and PSA, Ref Level Offset was applied to the data as it was acquired; thus if the Offset changed the new offset was not applied until new trace data was taken. In X-Series, the offset is applied as the data is displayed/queried, so if you change the offset, it will change the data immediately.
Initial S/W Revision	Prior to A.02.00
Modified at S/W Revision	A.04.00

More Information

Offsets are used when gain or loss occurs between a device under test and the analyzer input. Thus, the signal level measured by the analyzer may be thought of as the level at the input of an external amplitude conversion device. Entering an offset does not affect the trace position or attenuation value, just the value of the top line of the display and the values represented by the trace data. Thus, the values of exported trace data, queried trace data, marker amplitudes, trace data used in calculations such as N dB points, trace math, peak threshold, and so forth, are all affected by Ref Level Offset.

NOTE Changing the offset causes the analyzer to immediately stop the current sweep and prepare to begin a new sweep, but the data will not change until the trace data updates, because the offset is applied to the data as it is taken. If a trace is exported with a nonzero Ref Level Offset, the exported data will contain the trace data with the offset applied.

The maximum reference level available is dependent on the reference level offset. That is, Ref Level - Ref Level Offset must be in the range -170 to $+30$ dBm. For example, the reference level value range can be initially set to values from -170 dBm to 30 dBm with no reference level offset. If the reference level is first set to -20 dBm, then the reference level offset can be set to values of -150 to $+50$ dB.

If the reference level offset is first set to -30 dB, then the reference level can be set to values of -200 dBm to 0 dBm. In this case, the reference level is “clamped” at 0 dBm because the maximum limit of $+30$ dBm is reached with a reference level setting of 0 dBm with an offset of -30 dB. If instead, the reference level offset is first set to 30 dB, then the reference level can be set to values of -140 to $+60$ dBm.

μ W Path Control

The **μ W Path Control** functions include the **μ W Preselector Bypass** (Option MPB) and **Low Noise Path** (Option LNP) controls in the High Band path circuits.

When the μ W Preselector is bypassed, the user has better flatness, but will be subject to spurs from out of band interfering signals. When the Low Noise Path is enabled, the analyzer automatically switches around certain circuitry in the high frequency bands which can contribute to noise, when it is appropriate based on other analyzer settings.

For most applications, the preset state is Standard Path, which gives the best remote-control throughput, minimizes acoustic noise from switching and minimizes the risk of wear out in the hardware switches. For applications that utilize the wideband IF paths, the preset state is the μ W Preselector Bypass path, if option MPB is present. This is because, when using a wideband IF such as the 140 MHz IF, the μ W

Common Measurement Functions 1

Preselector's bandwidth can be narrower than the available IF bandwidth, causing degraded amplitude flatness and phase linearity, so it is desirable to bypass the preselector in the default case.

Users may choose Low Noise Path Enable. It gives a lower noise floor, especially in the 21–26.5 GHz region, though without improving many measures of dynamic range, and without giving the best possible noise floor. The preamp, if purchased and used, gives better noise floor than does the Low Noise Path, however its compression threshold and third-order intercept are much poorer than that of the non-preamp Low Noise Path. There are some applications, typically for signals around 30 dBm, for which the third-order dynamic range of the standard path is good enough, but the noise floor is not low enough even with 0 dB input attenuation. When the third-order dynamic range of the preamp path is too little and the noise floor of the standard path is too high, the Low Noise Path can provide the best dynamic range.

Key Path	AMPTD Y Scale
Mode	SA, BASIC, PNOISE, VSA , LTE, LTETDD
Scope	Meas Global
Remote Command	[:SENSE] :POWER[:RF] :MW:PATH STD LNPath MPBypass FULL [:SENSE] :POWER[:RF] :MW:PATH?
Example	:POW:MW:PATH LNP Enables the Low Noise path
Notes	<p>If a Presel Center is performed, the analyzer will momentarily switch to the Standard Path, regardless of the setting of µW Path Control</p> <p>The DC Block will always be switched in when the low noise path is switched in, to protect succeeding circuitry from DC. Note that this does not mean “when the low noise path is enabled” but when, based on the Low Noise Path rules, the path is actually switched in. This can happen when the selection is Low Noise Path Enable . In the case where the DC Block is switched in the analyzer is now AC coupled. However, if the user has selected DC coupling, the UI will still behave as though it were DC coupled, including all annunciation, warnings, status bits, and responses to SCPI queries. This is because, based on other settings, the analyzer could switch out the low noise path at any time and hence go back to being DC coupled.</p> <p>Alignment switching ignores the settings in this menu, and restores them when finished.</p>
Dependencies	Unavailable in BBIQ and External Mixing
Preset	All modes other than IQ Analyzer mode and VXA: STD IQ Analyzer and VXA: MPB option present and licensed: MPB MPB option not present and licensed: STD
State Saved	Save in instrument state
Readback	Value selected in the submenu
Initial S/W Revision	A.04.00

Standard Path

This path gives the best remote-control throughput, minimizes acoustic noise from switching and minimizes the risk of wear in the hardware switches, particularly in remote test scenarios where both low band and high band setups will follow in rapid succession.

In this path, the bypass of the low band/high band switch and microwave preamp is never activated, which can cause some noise degradation but preserves the life of the bypass switch.

Key Path	AMPTD Y Scale, μW Path Control
Example	:POW:MW:PATH STD
Readback Text	Standard Path
Initial S/W Revision	A.04.00

Low Noise Path Enable

You may choose Low Noise Path Enable, which gives a lower noise floor under some circumstances, particularly when operating in the 21–26.5 GHz region. With the Low Noise Path enabled, the low band/high band switch and microwave preamp are bypassed whenever all of the following are true:

- The analyzer is not in the Low Band, meaning:
- the start frequency is above 3.5 GHz and
- the stop frequency is above 3.6 GHz.
- the internal preamp is not installed or (if installed) is set to **Off** or **Low Band**

Note that this means that, when any part of a sweep is done in Low Band, the Low Noise Path is not used, whether or not the **Low Noise Path Enable** is selected in the user interface. Also, if the preamp is turned on, the Low Noise Path is not used, whether or not the **Low Noise Path Enable** is selected in the user interface. The only time the Low Noise Path is used is when **Low Noise Path Enable** is selected, the sweep is completely in High Band (> 3.6 GHz) and no preamp is in use.

See [“More Information” on page 1408](#)

Key Path	AMPTD Y Scale, μW Path Control
Measurement	Swept SA
Example	:POW:MW:PATH LNP
Notes	<p>For measurements that use IQ acquisition, the low noise path is used when the Center Frequency is in High Band (> 3.6 GHz) and no preamp is in use.</p> <p>In other words, the rules above are modified to use only the center frequency to qualify which path to switch in.</p> <p>This is not the case for FFT's in the Swept SA measurement; they use the same rules as swept measurements.</p>

Common Measurement Functions 1

Dependencies	Key is blanked if current mode does not support it. Key is grayed out if mode supports it but current measurement does not support it. Unless Option LNP is present and licensed, key is blank and if SCPI command sent, error -241, "Hardware missing; Option not installed" is generated.
Readback Text	Low Noise Path Enable
Initial S/W Revision	A.04.00

More Information

The user should understand that the Low Noise Path, while giving improved DANL, has the disadvantage of decreased TOI performance and decreased gain compression performance relative to the standard path.

The user should also understand that the bypass switch is a mechanical switch and has finite life; so if the **Low Noise Path** is enabled, it is possible to cause frequent cycling of this switch by frequently changing analyzer settings such that the above conditions hold true only some of the time. A user making tests of this nature should consider opting for the **Standard Path**, which will never throw the bypass switch, at the expense of some degraded noise performance.

The low noise path is useful for situations where the signal level is so low that the analyzer performance is dominated by noise even with 0 dB attenuation, but still high enough that the preamp option would have excessive third-order intermodulation or compression. The preamp, if purchased and used, gives better noise floor than does the "Low Noise Path." However, its compression threshold and third-order intercept are much poorer than that of the non-preamp path. There are some applications, typically for signals around 30 dBm, for which the third-order dynamic range of the standard path is good enough, but the noise floor is not low enough even with 0 dB input attenuation. When the third-order dynamic range of the preamp path is too little and the noise floor of the standard path is too high, the Low Noise Path can provide the best dynamic range

The graph below illustrates the concept. It shows, in red, the performance of an analyzer at different attenuation settings, both with the preamp on and off, in a measurement that is affected by both analyzer noise and analyzer TOI. The green shows the best available dynamic range, offset by 0.5 dB for clarity. The blue shows how the best available dynamic range improves for moderate signal levels with the low noise path switched in. In this illustration, the preamp improves the noise floor by 15 dB while degrading the third-order intercept by 30 dB, and the low noise path reduces loss by 8 dB. The attenuator step size is 2 dB.

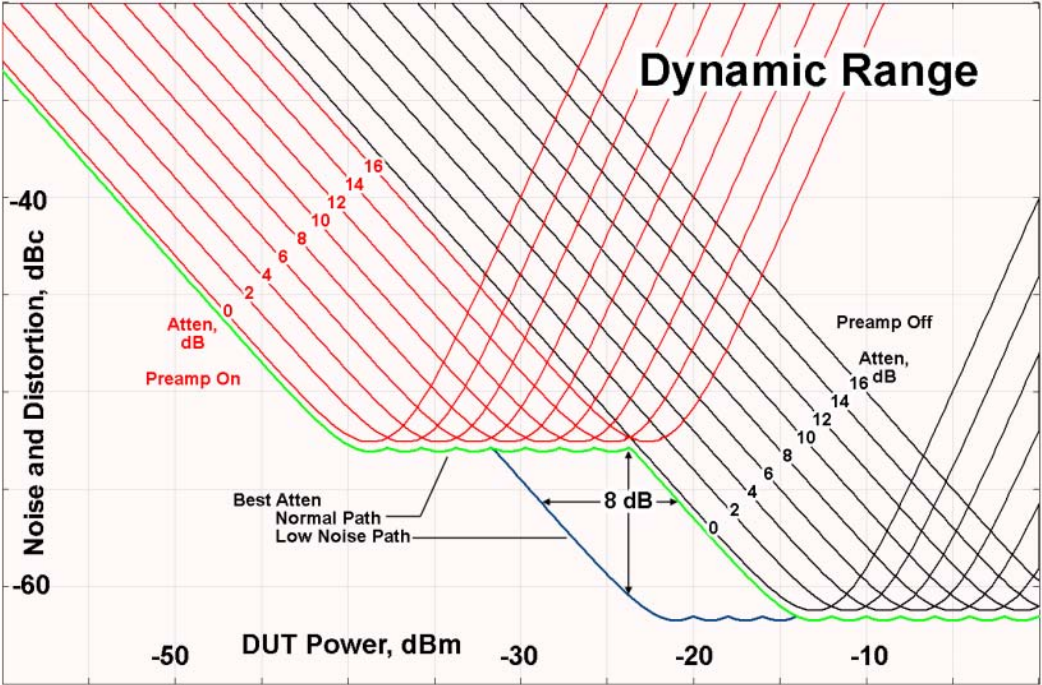

There are other times where selecting the low noise path improves performance, too. Compression-limited measurements such as finding the nulls in a pulsed-RF spectrum can profit from the low noise path in a way similar to the TOI-limited measurement illustrated. Accuracy can be improved when the low noise path allows the optimum attenuation to increase from a small amount like 0, 2 or 4 dB to a larger amount, giving better return loss at the analyzer input. Harmonic measurements, such as second and third harmonic levels, are much improved using the low noise path because of the superiority of that path for harmonic (though not intermodulation) distortion performance.

µW Preselector Bypass

This key toggles the preselector bypass switch for band 1 and higher. When the microwave preselector is on, the signal path is preselected. When the microwave preselector is off, the signal path is not preselected. The preselected path is the normal path for the analyzer.

The preselector is a tunable bandpass filter which prevents signals away from the frequency of interest from combining in the mixer to generate in-band spurious signals (images). The consequences of using a preselector filter are its limited bandwidth, the amplitude and phase ripple in its passband, and any amplitude and phase instability due to center frequency drift.

Option MPB or pre-selector bypass provides an unpreselected input mixer path for certain X-Series signal analyzers with frequency ranges above 3.6 GHz. This signal path allows a wider bandwidth and less amplitude variability, which is an advantage when doing modulation analysis and broadband signal analysis. The disadvantage is that, without the preselector, image signals will be displayed. Another disadvantage of bypassing the preselector is increased LO emission levels at the front panel input port.

Key Path	AMPTD Y Scale, µW Path Control
Example	:POW:MW:PATH MPB

Common Measurement Functions 1

Dependencies	Key is blanked if current mode does not support it. Key is grayed out if mode supports it but current measurement does not support it. Key is blank unless Option MPB is present and licensed. If SCPI command sent when MPB not present, error -241, "Hardware missing; Option not installed" is generated.
Readback Text	μ W Preselector Bypass
Initial S/W Revision	A.04.00

Remote Command	[:SENSe]:POWer[:RF]:MW:PRESelector[:STATe] ON OFF 0 1 [:SENSe]:POWer[:RF]:MW:PRESelector[:STATe]?
Example	:POW:MW:PRES OFF Bypasses the microwave preselector
Notes	The ON parameter sets the STD path (:POW:MW:PATH STD) The OFF parameter sets path MPB (:POW:MW:PATH MPB)
Preset	ON

Internal Preamp

Accesses a menu of keys that control the internal preamps. Turning on the preamp gives a better noise figure, but a poorer TOI to noise floor dynamic range. You can optimize this setting for your particular measurement.

The instrument takes the preamp gain into account as it sweeps. If you sweep outside of the range of the preamp the instrument will also account for that. The displayed result will always reflect the correct gain.

Key Path	AMPTD Y Scale
Scope	Meas Global
Remote Command	[:SENSe]:POWer[:RF]:GAIN[:STATe] OFF ON 0 1 [:SENSe]:POWer[:RF]:GAIN[:STATe]?
Dependencies	Preamp is not available on all hardware platforms. If the preamp is not present or is unlicensed, the key is not shown. The preamp is not available when the electronic/soft attenuator is enabled.
Preset	OFF
State Saved	Saved in instrument state
Initial S/W Revision	Prior to A.02.00

Key Path	AMPTD Y Scale, Internal Preamp
----------	---------------------------------------

Scope	Meas Global
Remote Command	[:SENSe]:POWer[:RF]:GAIN:BAND LOW FULL [:SENSe]:POWer[:RF]:GAIN:BAND?
Dependencies	Preamp is not available on all hardware platforms. If the preamp is not present or is unlicensed, the key is not shown. If a POW:GAIN:BAND FULL command is sent when a low band preamp is available, the preamp band parameter is to LOW instead of FULL, and an "Option not installed" message is generated.
Preset	LOW
State Saved	Saved in instrument state
Initial S/W Revision	Prior to A.02.00

Off

Turns the internal preamp off

Key Path	AMPTD Y Scale, Internal Preamp
Example	:POW:GAIN OFF
Readback	Off
Initial S/W Revision	Prior to A.02.00

Low Band

Sets the internal preamp to use only the low band.

The frequency range of the installed (optional) low-band preamp is displayed in square brackets on the **Low Band** key label.

Key Path	AMPTD Y Scale, Internal Preamp
Example	:POW:GAIN ON :POW:GAIN:BAND LOW
Readback	Low Band
Initial S/W Revision	Prior to A.02.00

Full Range

Sets the internal preamp to use its full range. The low band (0–3.6 GHz or 0–3GHz, depending on the model) is supplied by the low band preamp and the frequencies above low band are supplied by the high band preamp.

The frequency range of the installed (optional) preamp is displayed in square brackets on the **Full Range**

Common Measurement Functions 1

key label. If the high band option is not installed the Full Range key does not appear.

Key Path	AMPTD Y Scale, Internal Preamp
Example	:POW:GAIN ON :POW:GAIN:BAND FULL
Readback	Full Range
Initial S/W Revision	Prior to A.02.00

Auto Couple

The Auto Couple feature provides a quick and convenient way to automatically couple multiple instrument settings. This helps ensure accurate measurements and optimum dynamic range. When the Auto Couple feature is activated, either from the front panel or remotely, all parameters of the current measurement which have an Auto/Manual mode are set to Auto mode and all measurement settings dependent on (or coupled to) the Auto/Man parameters are automatically adjusted for optimal performance.

However, the Auto Couple keyactions are confined to the current measurement only. It does not affect other measurements in the mode, and it does not affect markers, marker functions, or trace or display attributes.

See [“More Information” on page 1412](#)

Key Path	Front-panel key
Remote Command	:COUPle ALL NONE
Example	:COUP ALL
Notes	:COUPle ALL puts all Auto/Man parameters in Auto mode (equivalent to pressing the Auto Couple key). :COUPLE NONE puts all Auto/Man parameters in manual mode. It decouples all the coupled instrument parameters and is not recommended for making measurements.
Initial S/W Revision	Prior to A.02.00

More Information

There are two types of functions that have Auto/Manual modes.

Auto/Man Active Function keys

An Auto/Man toggle key controls the binary state associated with an instrument parameter by toggling between "Auto" (where the parameter is automatically coupled to the other parameters it is dependent upon) and "Man" (where the parameter is controlled independent of the other parameters), as well as making the parameter the active function. The current mode is indicated on the softkey with either "Auto" or "Man" underlined as illustrated below.

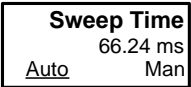

vsd07

Auto/Man 1-of-N keys

An Auto/Man 1-of-N key allows you to manually pick from a list of parameter values, or place the function in "Auto" in which case the value is automatically selected (and indicated) as shown below. If in Auto, Auto is underlined on the calling key. If in manual operation, manual is indicated on the calling key. But the calling key does not actually toggle the function, it simply opens the menu.

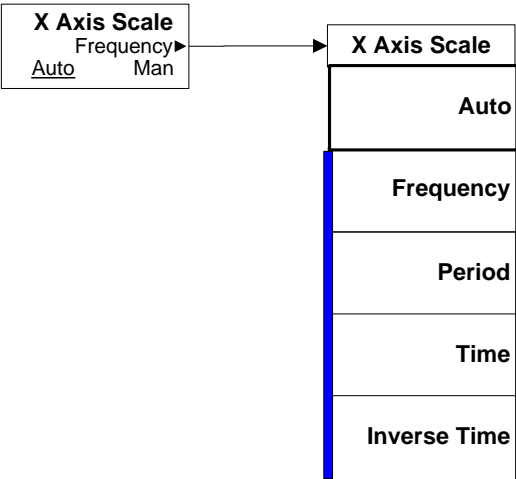

vsd08

Cont (Continuous Measurement/Sweep)

Sets the analyzer for Continuous measurement operation. The single/continuous state is Meas Global so the setting will affect all measurements. If you are Paused, pressing **Cont** does a Resume.

Key Path:	Front panel key
Remote Command:	:INITiate:CONTinuous OFF ON 0 1 :INITiate:CONTinuous?
Example:	:INIT:CONT 0 puts analyzer in Single measurement operation. :INIT:CONT 1 puts analyzer in Continuous measurement operation
Preset:	ON (Note that SYST:PRESet sets INIT:CONT to ON but *RST sets INIT:CONT to OFF)
State Saved:	Saved in instrument state

Common Measurement Functions 1

Backwards Compatibility Notes:	<p>For Spectrum Analysis mode in ESA and PSA, there is no Cont hardkey, instead there is a Sweep Single/Cont softkey. In these analyzers, switching the Sweep Single/Cont softkey from Single to Cont restarts averages (displayed average count reset to 1), but does not restart Max Hold and Min Hold.</p> <p>The X-Series has Single and Cont hardkeys in place of the Sweep Single Cont softkey. In the X-Series, if in single measurement, the Cont hardkey (and INIT:CONT ON) switches to continuous measurement, but never restarts a measurement and never resets a sweep.</p>
Initial S/W Revision:	Prior to A.02.00

In Swept SA Measurement (Spectrum Analysis Mode):

The analyzer takes repetitive sweeps, averages, measurements, etc., when in Continuous mode. When the average count reaches the Average/Hold Number the count stops incrementing, but the analyzer keeps sweeping. See the Trace/Detector section for the averaging formula used both before and after the Average/Hold Number is reached. The trigger condition must be met prior to each sweep. The type of trace processing for multiple sweeps, is set under the Trace/Detector key, with choices of **Trace Average**, **Max Hold**, or **Min Hold**.

In Other Measurements/Modes:

With **Avg/Hold Num** (in the **Meas Setup** menu) set to **Off** or set to **On** with a value of 1, a sweep is taken after the trigger condition is met; and the analyzer continues to take new sweeps after the current sweep has completed and the trigger condition is again met. However, with **Avg/Hold Num** set to **On** with a value >1, multiple sweeps (data acquisitions) are taken for the measurement. The trigger condition must be met prior to each sweep. The sweep is not stopped when the average count k equals the number N set for Avg/Hold Num is reached, but the number k stops incrementing. A measurement average usually applies to all traces, marker results, and numeric results. But sometimes it only applies to the numeric results.

If the analyzer is in Single measurement, pressing the **Cont** key does not change k and does not cause the sweep to be reset; the only action is to put the analyzer into Continuous measurement operation.

If it is already in continuous sweep:

the INIT:CONT 1 command has no effect

the INIT:CONT 0 command will place the analyzer in Single Sweep but will have no effect on the current sequence until $k = N$, at which point the current sequence will stop and the instrument will go to the idle state.

FREQ Channel

Accesses a menu of keys that allow you to control the Frequency and Channel parameters of the instrument.

Some features in the Frequency menu are the same for all measurements – they do not change as you change measurements. Settings like these are called “Meas Global” and are unaffected by Meas Preset. For example, the Center Freq setting is the same for all measurements - it does not change as you change

measurements.

Key Path	Front-panel key
Initial S/W Revision	Prior to A.02.00

Center Freq

Sets the frequency that corresponds to the horizontal center of the graticule (when frequency Scale Type is set to linear). While adjusting the Center Frequency the Span is held constant, which means that both Start Frequency and Stop Frequency will change.

Pressing Center Freq also sets the frequency entry mode to Center/Span. In Center/Span mode, the center frequency and span values are displayed below the graticule, and the default active function in the Frequency menu is **Center Freq**.

The center frequency setting is the same for all measurements within a mode, that is, it is Meas Global. Some modes are also able to share a Mode Global center frequency value. If this is the case, the Mode will have a **Global Settings** key in its **Mode Setup** menu.

The **Center Freq** function sets (and queries) the Center Frequency for the currently selected input. If your analyzer has multiple inputs, and you select another input, the Center Freq changes to the value for that input. SCPI commands are available to directly set the Center Freq for a specific input.

Center Freq is remembered as you go from input to input. Thus you can set a Center Freq of 10 GHz with the RF Input selected, change to BBIQ and set a Center Freq of 20 MHz, then switch to External Mixing and set a Center Freq of 60 GHz, and when you go back to the RF Input the Center Freq will go back to 10 GHz; back to BBIQ and it is 20 MHz; back to External Mixing and it is 60 GHz.

See [“RF Center Freq” on page 1418](#)

See [“Ext Mix Center Freq” on page 1419](#)

See [“I/Q Center Freq” on page 1420](#)

See [“Center Frequency Presets” on page 1416](#)

Key Path	FREQ Channel
Scope	Meas Global
Remote Command	[:SENSe] :FREQuency:CENTer <freq> [:SENSe] :FREQuency:CENTer?
Example	FREQ:CENT 50 MHz FREQ:CENT UP changes the center frequency to 150 MHz if you use FREQ:CENT:STEP 100 MHz to set the center frequency step size to 100 MHz FREQ:CENT?

Common Measurement Functions 1

Notes	<p>This command sets either the RF or I/Q Center Frequency depending on the selected input.</p> <p>For RF input it is equivalent to <code>FREQ:RF:CENT</code></p> <p>For I/Q input it is equivalent to <code>FREQ:IQ:CENT</code></p> <p>Preset and Max values are dependent on Hardware Options (5xx)</p> <p>If no terminator (e.g. MHz) is sent the terminator Hz is used. If a terminator with unit other than Frequency is used, an invalid suffix error message is generated.</p>
Dependencies	The Center Frequency can be limited by Start or Stop Freq limits, if the Span is so large that Start or Stop hit their limit.
Couplings	When operating in “swept span”, any value of the Center Frequency or Span that is within the frequency range of the analyzer is allowed when the value is being set through the front panel numeric key pad or the SCPI command. The other parameter is forced to a different value if needed, to keep the Start and the Stop Frequencies within the analyzer’s frequency range
Preset	<p>Depends on instrument maximum frequency, mode, measurement, and selected input.</p> <p>See REF T_CF_CFPresets \h *CHARFORMAT - and REF T_RFCF_MoreInformation \h *CHARFORMAT - and HYPERLINK \l "T_ExtMixCF_MoreInformation" - and REF T_IQCF_MoreInformation \h *CHARFORMAT -.</p>
State Saved	Saved in instrument state
Min	<p>Depends on instrument maximum frequency, mode, measurement, and selected input..</p> <p>See “Center Frequency Presets” on page 1416 and “RF Center Freq” on page 1418 and “I/Q Center Freq” on page 1420.</p>
Max	<p>Depends on instrument maximum frequency, mode, measurement, and selected input..</p> <p>See “Center Frequency Presets” on page 1416 and “RF Center Freq” on page 1418 and “I/Q Center Freq” on page 1420.</p>
Default Unit	Hz
Status Bits/OPC Dependencies	non-overlapped
Initial S/W Revision	Prior to A.02.00

Center Frequency Presets

The following table provides the Center Frequency Presets for the Spectrum Analyzer mode, and the Max Freq, for the various frequency options:

Freq Option	CFafter Mode Preset	Stop Freq after Mode Preset	Max Freq(can't tune above)
-------------	---------------------	-----------------------------	----------------------------

503 (all but N9000A)	1.805 GHz	3.6 GHz	3.7 GHz
503 (N9000A)	1.505 GHz	3.0 GHz	3.08 GHz
507 (all but N9000A)	3.505 GHz	7.0 GHz	7.1 GHz
507 (N9000A)	3.755 GHz	7.5 GHz	7.58 GHz
508 (all but N9038A)	1.805 GHz	3.6 GHz	8.5 GHz
508 (N9038A)	4.205 GHz	8.4 GHz	8.5 GHz
513	6.805 GHz	13.6 GHz	13.8 GHz
526 (all but N9038A)	13.255 GHz	26.5 GHz	27.0 GHz
526 (N9038A)	1.805 GHz	3.6 GHz	27.0 GHz
543	21.505 GHz	43.0 GHz	TBD
544	22.005 GHz	44.0 GHz	44.5 GHz
550	25.005 GHz	50.0 GHz	51 GHz

N9038A, Input 2:

5xx	505 MHz	1 GHz	1.000025 GHz
-----	---------	-------	--------------

Tracking Generator Frequency Limits (N9000A only):

Tracking Generator Option	Min Freq (clips to this freq when turn TG on and can't tune below while TG on)	If above this Freq, Stop Freq clipped to this Freq when TG turned on	Max Freq (can't tune above) while TG on
T03	9 kHz	3.0 GHz	3.08 GHz
T06	9 kHz	6.0 GHz	6.05 GHz

Common Measurement Functions 1

The following table shows the Center Frequency Presets for modes other than Spectrum Analyzer:

Mode	CF Preset for RF
WCDMA	1 GHz
WIMAXOFDMA,	1 GHz
BASIC	1 GHz
ADEMOD	1 GHz
VSA	1 GHz
TDSCDMA	1 GHz
PNOISE	1 GHz
LTE	1 GHz
LTETDD	1 GHz
MSR	1 GHz
GSM	935.2 MHz
NFIGURE	1.505 GHz

RF Center Freq

SCPI command for specifying the RF Center Frequency. This command will set the Center Frequency to be used when the RF input is selected, even if the RF input is not the input which is selected at the time the command is sent. Note that the **Center Freq** function in the **Frequency** menu on the front panel always applies to the currently selected input.

Scope	Meas Global
Remote Command	[:SENSe] :FREQuency:RF:CENTer <freq> [:SENSe] :FREQuency:RF:CENTer?
Example	FREQ:RF:CENT 30 MHz
Notes	This command is the same in all modes, but the parameter is Measurement Global. So the value is independent in each mode and common across all the measurements in the mode.

Dependencies	<p>If the electronic/soft attenuator is enabled, any attempt to set Center Frequency such that the Stop Frequency would be >3.6 GHz fails and results in an advisory message. If the equivalent SCPI command is sent, this same message is generated as part of a “-221, Settings conflict” warning.</p> <p>If Source Mode is set to Tracking, and the Max or Min Center Freq is therefore limited by the limits of the source, a warning message is generated, “Data out of range;clipped to source max/min” if these limits are exceeded. Note that for an external source, these limits can be affected by the settings of Source Numerator, Source Denominator and Power Sweep.</p>
Preset	See table above
State Saved	Saved in instrument state.
Min	-79.999995 MHz, unless Source Mode is set to Tracking, in which case it is limited by the minimum frequency of the Source
Max	<p>See table above. Basically instrument maximum frequency – 5 Hz. Note that, if the Source Mode is set to Tracking, the effective instrument maximum frequency may be limited by the source maximum frequency.</p> <p>If the knob or step keys are being used, also depends on the value of the other three interdependent parameters Span, Start Frequency and Stop Frequency</p>
Initial S/W Revision	Prior to A.02.00
Modified at S/W Revision	A.03.00

Ext Mix Center Freq

SCPI command for specifying the External Mixer Center Frequency. This command will set the Center Frequency to be used when the External Mixer is selected, even if the External Mixer input is not the input which is selected at the time the command is sent. Note that the **Center Freq** function in the **Frequency** menu on the front panel always applies to the currently selected input.

Scope	Meas Global
Remote Command	<pre>[:SENSe] :FREQuency :EMIXer :CENTer <freq> [:SENSe] :FREQuency :EMIXer :CENTer ?</pre>
Example	<pre>:FREQ:EMIX:CENT 60 GHz :FREQ:EMIX:CENT ?</pre>
Notes	This command is the same in all modes, but the parameter is Measurement Global. So the value is independent in each mode and common across all the measurements in the mode.

Common Measurement Functions 1

Couplings	When returning to External Mixing after having been switched to one of the other inputs (e.g., RF), you will come back into the settings that you had when you left External Mixing. So you will come back to the band you were in with the Center Frequency that you had. However, Span is not an input-dependent parameter, therefore you will bring the span over from the other input. Therefore, the analyzer comes back with the span from the previous input, limited as necessary by the current mixer setup.
Preset	<p>When a Mode Preset is performed while in External Mixing, the Start frequency of the current Mode is set to the nominal Min Freq of the lowest harmonic range in the Harmonic Table for the current mixer setup. Similarly, the Stop frequency of the current Mode is set to the nominal Max Freq of the highest harmonic range in the Harmonic Table. The Center Freq thus presets to the point arithmetically equidistant from these two frequencies.</p> <p>NOTE: if the current measurement has a limited Span available to it, and cannot achieve the Span shown in the table (Span=Stop Freq – Start Freq), the analyzer uses the maximum Span the measurement allows, and still sets the Center Freq to the midpoint of the Start and Stop Freq values in the Harmonic Table.</p> <p>When Restore Input/Output Defaults is performed, the mixer presets to the 11970A, whose Start and Stop frequencies are 26.5 and 40 GHz respectively. The center of these two frequencies is 33.25 GHz.</p> <p>Therefore, after a Restore Input/Output Defaults, if you go into External Mixing and do a Mode Preset while in the Spectrum Analyzer Mode, the resulting Center Freq is 33.25 GHz.</p>
State Saved	Saved in instrument state.
Min	The minimum frequency in the currently selected mixer band + 5 Hz
Max	<p>The maximum frequency in the currently selected mixer band – 5 Hz</p> <p>If the knob or step keys are being used, also depends on the value of the other three interdependent parameters Span, Start Frequency and Stop Frequency</p>
Initial S/W Revision	A.08.01

I/Q Center Freq

SCPI command for specifying the I/Q Center Frequency. This command will set the Center Frequency to be used when the I/Q input is selected, even if the I/Q input is not the input which is selected at the time the command is sent. Note that the **Center Freq** function in the **Frequency** menu on the front panel always applies to the currently selected input.

Scope	Meas Global
Remote Command	<pre>[:SENSe] :FREQuency :IQ :CENTer <freq></pre> <pre>[:SENSe] :FREQuency :IQ :CENTer?</pre>

Example	FREQ:IQ:CENT: 30 MHz
Notes	This command is the same in all modes, but the parameter is Measurement Global. So the value is independent in each mode and common across all the measurements in the mode.
Preset	0 Hz
State Saved	Saved in instrument state.
Min	-40.049995 MHz
Max	40.049995 MHz
Initial S/W Revision	Prior to A.02.00

CF Step

Changes the step size for the center frequency and start and stop frequency functions. Once a step size has been selected and the center frequency function is active, the step keys (and the UP|DOWN parameters for Center Frequency from remote commands) change the center frequency by the step-size value. The step size function is useful for finding harmonics and sidebands beyond the current frequency span of the analyzer.

Note that the start and stop frequencies also step by the CF Step value.

Key Path	FREQ Channel
Remote Command	[:SENSE] :FREQuency:CENTer:STEP[: INCRement] <freq> [:SENSE] :FREQuency:CENTer:STEP[: INCRement]? [:SENSE] :FREQuency:CENTer:STEP:AUTO OFF ON 0 1 [:SENSE] :FREQuency:CENTer:STEP:AUTO?
Example	FREQ:CENT:STEP:AUTO ON FREQ:CENT:STEP 500 MHz FREQ:CENT UP increases the current center frequency value by 500 MHz FREQ:CENT:STEP? FREQ:CENT:STEP:AUTO?
Notes	Preset and Max values are depending on Hardware Options (503, 507, 508, 513, 526)
Notes	Preset and Max values are dependent on Hardware Options (5xx)
Dependencies	Freq Offset is not available in External Mixing. In this case the Freq Offset key is grayed out and shows a value of zero. It will once again be available, and show the previously set value, when you return to the RF Input.

Common Measurement Functions 1

Dependencies	Span, RBW, Center frequency If the electronic/soft attenuator is enabled, any attempt to change the value of the center frequency >3.6 GHz by pressing the Up-arrow key, fails and results in an advisory message. If the equivalent SCPI command is sent, this same message is generated as part of a “-221, Settings conflict” warning.
Couplings	When auto-coupled in a non-zero span, the center frequency step size is set to 10% of the span. When auto-coupled in zero span, the center frequency step size is set to the equivalent -3 dB RBW value.
Preset	Auto ADEMOD: 1 MHz ON
State Saved	Saved in instrument state
Min	- (the maximum frequency of the instrument). That is, 27 GHz max freq instrument has a CF step range of +/- 27 GHz. Note that this is the maximum frequency given the current settings of the instrument, so in External Mixing, for example, it is the maximum frequency of the current mixer band.
Max	the maximum frequency of the instrument. That is, 27 GHz max freq instrument has a CF step range of +/- 27 GHz. Note that this is the maximum frequency given the current settings of the instrument, so in External Mixing, for example, it is the maximum frequency of the current mixer band.
Default Unit	Hz
Status Bits/OPC dependencies	non-overlapped
Initial S/W Revision	Prior to A.02.00
Modified at S/W Revision	A.03.00

Input/Output

The Input/Output features are common across multiple Modes and Measurements. These common features are described in this section. See the Measurement description for information on features that are unique.

The Input/Output key accesses the softkeys that control the Input/Output parameters of the instrument. In general, these are functions associated with external connections to the analyzer, either to the inputs or the outputs. Since these connections tend to be fairly stable within a given setup, in general, the input/output settings do not change when you Preset the analyzer.

Other functions related to the input/output connections, but which tend to change on a measurement by measurement basis, can be found under the **Trigger** and **AMPTD Y Scale** keys. In addition, some of the digital I/O bus configurations can be found under the **System** key.

NOTE The functions in the Input/Output menu are "global" (common) to all Modes (applications). But individual Input/Output functions only appear in a Mode if they apply to that Mode. Functions that apply to a Mode but not to all

measurements in the Mode may be grayed-out in some measurements.

[“Input/Output variables - Preset behavior” on page 1425](#)

The Input Port selection is the first menu under the **Input/Output** key:

Remote Command:	[:SENSe] :FEED RF AIQ EMIXer [:SENSe] :FEED?
Example:	:FEED RF :FEED?
Couplings:	The [:SENSe]:FEED RF command turns the calibrator OFF
Preset:	This setting is unaffected by a Preset or power cycle. It survives a Mode Preset and mode changes. It is set to RF on a "Restore Input/Output Defaults" or "Restore System Defaults->All"
State Saved:	Saved in instrument state
Backwards Compatibility SCPI:	[:SENSe]:FEED AREFERENCE In the PSA the calibrator was one of the inputs and selected using the AREF parameter to the same :FEED command that switched the inputs. In the X-Series it is controlled in a separate menu and overrides the input selection. For code compatibility the [:SENSe]:FEED AREFERENCE command is provided, and is aliased to [SENSe]:FEED:AREF REF50, which causes the input to be switched to the 50 MHz calibrator. The [:SENSe]:FEED RF command switches the input back to the RF port and turns the calibrator OFF, thus providing full compatibility with the PSA calibrator function. Note that after sending this, the query [:SENSe]:FEED? will NOT return “AREF” but instead the currently selected input.
Backwards Compatibility SCPI:	[:SENSe]:FEED IQ IONLy QONLy [:SENSe]:FEED? The parameters IQ IONLy QONLy are supported for backwards compatibility with the E44406A. [:SENSe]:FEED IQ aliases to [:SENSe]:FEED:IQ:TYPE IQ [:SENSe]:FEED IONLy aliases to [:SENSe]:FEED:IQ:TYPE IONLy [:SENSe]:FEED QONLy aliases to [:SENSe]:FEED:IQ:TYPE QONLy The query [:SENSe]:FEED? will always returns AIQ whatever the type of legacy parameters IQ IONLy QONLy has been used.

Common Measurement Functions 1

Backwards Compatibility Notes:	<p>Most of the settings in the X-Series Input/Output system, including External Gain, Amplitude Corrections settings and data, etc., are shared by all modes and are not changed by a mode switch. Furthermore, most variables in the Input/Output system key are not affected by Mode Preset. Both of these behaviors represent a departure from legacy behavior.</p> <p>In the X-Series. Input/Output settings are reset by using the "Restore Input/Output Defaults" function. They can also be reset to their default values through the System->Restore System Defaults-> In/Out Config key or through the System ->Restore System Defaults -> All key (and corresponding SCPI).</p> <p>While this matches most use cases better, it does create some code compatibility issues. For example, Amplitude Corrections are no longer turned off by a Mode Preset, but instead by using the "Restore Input/Output Defaults" key/SCPI.</p> <p>Although Input/Output settings are not part of each Mode's State, they are saved in the Save State files, so that all of the instrument settings can be recalled with Recall State, as in legacy instruments.</p>
Initial S/W Revision:	Prior to A.02.00

Remote Command:	<pre>:INPut:MIXer EXTernal INTernal :INPut:MIXer?</pre>
Example:	<pre>INP:MIX INT INP:MIX?</pre>
Notes:	<p>In legacy analyzers you choose between the Internal mixer or an External Mixer. In the X-Series, the External Mixer is one of the choices for the Input and hence is selected using the FEED command (:SENSe:FEED EXTMixer).</p> <p>For compatibility, the INPut:MIXer EXTernal INTernal legacy command is mapped as follows:</p> <ol style="list-style-type: none"> 1. When INPut:MIXer EXTernal is received, SENSe:FEED EMIXer is executed. 2. When INPut:MIXer INTernal is received, SENSe:FEED RF is executed. 3. When INPut:MIXer? is received, the response will be INT if any input other than the external mixer is selected and EXT if the external mixer is selected
Preset:	INT
Backwards Compatibility Notes:	<p>PSA supports the following SCPI Command :</p> <pre>:INPut:MIXer:TYPE PRESelected UNPReselect :INPut:MIXer:TYPE?</pre> <p>PXA does not support the :INPut:MIXer:TYPE command.</p>
Initial S/W Revision:	A.08.01

Input/Output variables - Preset behavior

Virtually all the input/output settings are NOT a part of mode preset. They can be set to their default value by one of the three ways - by using the Restore Input/Output Defaults key on the first page of the input/output menu, by using the System->Restore System Defaults->Input/Output Settings or by using the System -> Restore System Defaults->All. Also, they survive a Preset and a Power cycle.

A very few of the Input/Output settings do respond to a Mode Preset; for example, if the Calibrator is on it turns off on a Preset, and if DC coupling is in effect it switches to AC on a Preset. These exceptions are made in the interest of reliability and usability, which overrides the need for absolute consistency. Exceptions are noted in the SCPI table for the excepted functions.

RF Input

Selects the front-panel RF input port to be the analyzer signal input. If RF is already selected, pressing this key accesses the RF input setup functions.

Key Path:	Input/Output
Example:	[[:SENSE]:FEED RF
Readback:	The RF input port, RF coupling, and current input impedance settings appear on this key as: "XX, YY, ZZ" where XX is RF, RF2, RFIO1, RFIO2, depending on what input is selected (only appears on analyzers with multiple RF inputs) YY is AC or DC ZZ is 50 or 75
Initial S/W Revision:	Prior to A.02.00

Input Z Correction

Sets the input impedance for unit conversions. This affects the results when the y-axis unit is voltage or current units (dBmV, dBμV, dBμA, V, A), but not when it is power units (dBm, W). The impedance you select is for computational purposes only, since the actual impedance is set by internal hardware to 50 ohms. Setting the computational input impedance to 75 ohms is useful when using a 75 ohm to 50 ohm adapter to measure a 75 ohm device on an analyzer with a 50 ohm input impedance.

There are a variety ways to make 50 to 75 ohm transitions, such as impedance transformers or minimum loss pads. The choice of the solution that is best for your measurement situation requires balancing the amount of loss that you can tolerate with the amount of measurement frequency range that you need. If you are using one of these pads/adaptors with the **Input Z Corr** function, you might also want to use the **Ext Gain** key. This function is used to set a correction value to compensate for the gain (loss) through your pad. This correction factor is applied to the displayed measurement values.

Key Path:	Input/Output, RF Input
Remote Command:	[[:SENSE]:CORRection:IMPedance[:INPut][[:MAGNitude] 50 75 [:SENSE]:CORRection:IMPedance[:INPut][[:MAGNitude]?

Common Measurement Functions 1

Example:	CORR:IMP 75 sets the input impedance correction to 75 ohms. CORR:IMP?
Preset:	This is unaffected by a Preset but is set to 50 ohms on a "Restore Input/Output Defaults" or "Restore System Defaults->All" Some instruments/options may have 75 ohms available.
State Saved:	Saved in instrument state
Readback:	50 Ω or 75 Ω Current setting reads back to the RF key.
Initial S/W Revision:	Prior to A.02.00

RF Coupling

Specifies alternating current (AC) or direct current (DC) coupling at the analyzer RF input port. Selecting AC coupling switches in a blocking capacitor that blocks any DC voltage present at the analyzer input. This decreases the input frequency range of the analyzer, but prevents damage to the input circuitry of the analyzer if there is a DC voltage present at the RF input.

In AC coupling mode, you can view signals below the corner frequency of the DC block, but below a certain frequency the amplitude accuracy is not specified. The frequency below which specifications do not apply is:

X-Series Model	Lowest Freq for meeting specs when AC coupled	Lowest Freq for meeting specs when DC coupled
N9000A	100 kHz	n/a
N9010A	10 MHz	9 kHz
N9020A	10 MHz	3 Hz
N9030A	10 MHz	3 Hz

Some amplitude specifications apply only when coupling is set to DC. Refer to the appropriate amplitude specifications and characteristics for your analyzer.

When operating in DC coupled mode, ensure protection of the analyzer input circuitry by limiting the DC part of the input level to within 200 mV of 0 Vdc. In AC or DC coupling, limit the input RF power to +30 dBm (1 Watt).

Key Path:	Input/Output, RF Input
Remote Command:	:INPut:COUPling AC DC :INPut:COUPling?
Example:	INP:COUP DC

Dependencies:	<p>This key does not appear in models that are always AC coupled. When the SCPI command to set DC coupling is sent to these models, it results in the error “Illegal parameter value;This model is always AC coupled” In these models, the SCPI query INP:COUP? always returns AC.</p> <p>This key does not appear in models that are always DC coupled. When the SCPI command to set AC coupling is sent to these models, it results in the error “Illegal parameter value;This instrument is always DC coupled” In these models, the SCPI query INP:COUP? always returns DC.</p>
Preset:	<p>AC on models that support AC coupling</p> <p>On models that are always DC coupled, such as millimeter wave models (frequency ranges 30 GHz and above), the preset is DC.</p>
State Saved:	Saved in instrument state.
Initial S/W Revision:	Prior to A.02.00
Modified at S/W Revision:	A.03.00

RF Input Port

Specifies the RF input port used. The RF Input Port key only appears on units with multiple inputs, and lets you switch between the two inputs.

Switching from the RF input port to one of the RFIO ports, on units which have them, changes the receiver performance of the instrument.

Key Path:	Input/Output, RF Input
Remote Command:	<p>[:SENSe] :FEED:RF:PORT [:INPut] RFIN RFIN2 RFIO1 RFIO2</p> <p>[:SENSe] :FEED:RF:PORT [:INPut] ?</p>
Example:	:FEED:RF:PORT RFIN
Dependencies:	<p>This key only appears in models that support multiple inputs. If the SCPI command is sent with unsupported parameters in any other model, an error is generated, -221.1900, “Settings conflict;option not installed”</p> <p>When any input is selected in a measurement that does not support it, the "No result; Meas invalid with this input" error condition occurs, and the measurement returns invalid data when queried.</p>
Preset:	This is unaffected by Mode Preset but is set to RF on a "Restore Input/Output Defaults" or "Restore System Defaults -> All"
State Saved:	Saved in State
Backwards Compatibility SCPI:	<p>INPut<1 2>:TYPE INPUT1 INPUT2</p> <p>INPut<1 2>:TYPE?</p> <p>included for R&S ESU compatibility. In the MXE, the INPUT1 parameter is aliased to RFIN and the INPUT2 parameter is aliased to RFIN2</p>
Initial S/W Revision:	A.05.01

Common Measurement Functions 1

Read Back:	The current RF Input Port selected is read back to this key
------------	---

RF Input

Specifies using the main RF port for the current measurement

Key Path:	Input/Output, RF Input, RF Input Port
Example:	:FEED:RF:PORT RFIN
ReadBack:	RF Input
Initial S/W Revision:	A.05.01

RF Input 2

Specifies using the second RF port, if supported, for the current measurement. Note that in some cases (for example, the N9038A) the second input has a lower maximum frequency than the main RF port (input 1).

N9038A: the second input has a maximum frequency of 1 GHz. For your convenience, the actual “Max Freq” value is allowed to go slightly higher than 1 GHz, to 1.000025 GHz. So in the coupling equations shown in the table below, use 1.000025 GHz for Max Freq and 10 Hz for Min Span. Thus, in the N9038A, when switching from Input 1 to Input 2:

- If the Stop Freq is above 1.000025 GHz, it is set to 1.000025 GHz, otherwise it does not change.
- If the Start Freq is above 1.000024990 Hz, Start Freq is set to 1.000024990 Hz and Span to 10 Hz, otherwise nothing changes.

Key Path:	Input/Output, RF Input, RF Input Port
Example:	:FEED:RF:PORT RFIN2
Couplings:	<p>When switching from Input 1 to Input 2:</p> <ul style="list-style-type: none"> • If the Stop Freq is above the Max Freq, it is set to the Max Freq, otherwise it does not change. • If the Start Freq is above (Max Freq – Min Span), it is set to (Max Freq – Min Span), otherwise it does not change. <p>When switching from Input 2 to Input 1, neither the Start Freq nor the Stop Freq change.</p> <p>For the Swept SA measurement, Min Span is 10 Hz. This may vary from measurement to measurement.</p>
ReadBack:	RF Input 2
Initial S/W Revision:	A.05.01

RFIO1

Specifies using the RFIO 1 port, if supported, for the current measurement

Key Path:	Input/Output, RF Input, RF Input Port
-----------	--

Example:	:FEED:RF:PORT RFIO1
Dependencies:	Only available in EXT
ReadBack:	RFIO 1
Initial S/W Revision:	A.05.01

RFIO2

Specifies using the RFIO 2 port, if supported, for the current measurement

Key Path:	Input/Output, RF Input, RF Input Port
Example:	:FEED:RF:PORT RFIO2
Dependencies:	Only available in EXT
ReadBack:	RFIO 2
Initial S/W Revision:	A.05.01

RF Preselector

In models that support the RF Preselector, such as MXE (N9038A), this key allows you to turn the preselector on and off.

Key Path:	Input-Output, RF Setup
Mode:	All
Remote Command:	[:SENSE]:POWER[:RF]: RFPSelector [:STATE] 1 0 ON OFF [:SENSE]:POWER[:RF]: RFPSelector [:STATE]?
Example:	:POW:RFPS 1
Example:	:INP:PRES:STAT ON
Notes:	[:SENSE]:POWER[:RF]: RFPSelector [:STATE] 1 ON. Sets to full compliance measurement. [:SENSE]:POWER[:RF]: RFPSelector [:STATE] 0 OFF. Sets to pre-compliance measurement.

Common Measurement Functions 1

Dependencies:	<p>The RF Preselector is not available in all measurements. The key is grayed out in measurements that do not support it, unless you are in a Mode in which no measurements support it, in which case the key does not appear at all. If the preselector is unavailable it is forced to Off. Attempting to turn it on or off in measurements that do not support it generates an error message:</p> <p>–221.3200, Settings conflict; Feature not supported for this measurement.</p> <p>The RF Preselector is not available when FFT Sweep Type is manually selected. Attempting to turn it on or off when this is the case generates an error message:</p> <p>“–221, Settings conflict; RF Presel unavailable when Sweep Type=Manual FFT”.</p> <p>When using the preselector, if your measurement starts below 3.6 GHz and finishes above 3.6 GHz, the preselector bypass switch will have to switch in and out for every measurement. When this is the case, a warning message is displayed: “Settings Alert:Mechanical switch cycling”. You are advised to avoid such setups as much as possible, to minimize switch wear.</p> <p>This key only appears in Modes that support the RF Preselector, in other Modes, setting or querying the SCPI will generate an error.</p> <p>This key only appears in models that support the RF Preselector, in other models, setting or querying the SCPI will generate an error.</p>
Preset:	It is set to Off when mode selected is SA. If mode is EMI Receiver, then it will be set to On.
Backwards Compatibility SCPI:	<p>INPut<1 2>:PRESelection[:STATe] ON OFF</p> <p>INPut<1 2>:PRESelection[:STATe]?</p> <p>included for R&S ESU compatibility</p>

External Mixer

The **External Mixer** key allows you to choose an External Mixer through which to apply signal input to the analyzer. When **External Mixer** is chosen, the LO/IF port becomes the input to the analyzer.

External Mixing requires option EXM. The External Mixer key will not appear unless option EXM is installed. The presence of the LO/IF connector alone does not indicate that you have Option EXM licensed; you can verify that option EXM is installed by pressing **System, Show, System**.

When **External Mixer** is selected, the **Center Freq** key controls the setting of Center Freq in external mixing, which is separate from the settings of **Center Freq** for the RF Input or BBIQ. Each input retains its unique settings for **Center Freq**. A unique SCPI command is provided solely for the external mixing Center Freq (see the **Center Freq** key description) which only affects the External Mixer CF; although sending the generic Center Freq command while External Mixer is selected also controls the External Mixer CF.

See [“More Information” on page 1431](#)

Key Path:	Input/Output
Example:	:FEED EMIX

Notes:	Not all measurements support the use of the External Mixer input. When External Mixer is selected in a measurement that does not support it, the "No result; Meas invalid with Ext Mixing" error condition occurs.
Dependencies:	Unless option EXM is present, the External Mixer key is blanked, and all SCPI commands associated with menus accessed by this key return an error Manual FFT mode is available with external mixing, but not with Signal ID.
Preset:	All settings under this key are returned to their default state when Restore Input/Output Defaults is pressed.
State Saved:	All settings under this key, and all Frequency settings, are remembered when you go out of External Mixer, so that when External Mixer is chosen again, all the external mixer functions will retain their previous settings, with the exception of Signal ID which is set to OFF (Signal ID is also set to Off unless External Mixer is the selected Input).
Readback Text:	The readback text on this key shows the currently selected mixer, in square brackets.
Backwards Compatibility Notes:	Unlike PSA, all external mixer settings including Center Frequency are retained when you go in and out of External Mixing. Also, Preset does not take you out of External Mixing (Restore Input/Output Defaults does).
Initial S/W Revision:	A.08.01

More Information

X-series analyzers have a combined LO Out/IF In connection, whereas earlier analyzers used separate ports for the LO Out and the IF in. Internal duplexers in the analyzer and the mixer simplify the connection for the user – only a single SMA cable is required.

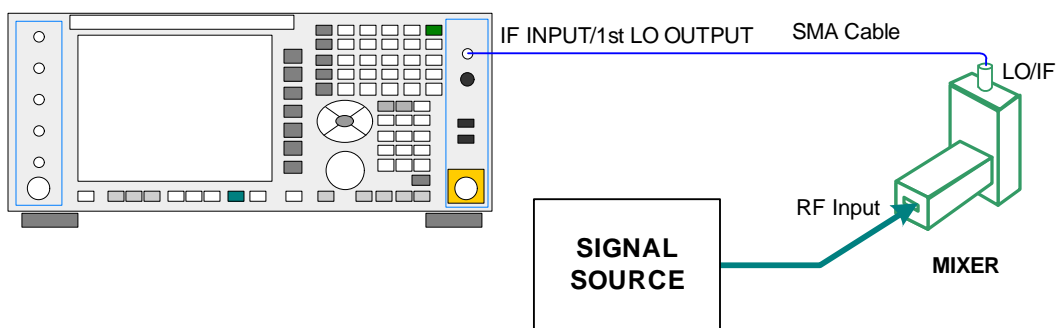

Legacy HP/Agilent and some third party mixers have separate LO In and IF out connections. This requires you to use an external diplexer to connect these mixers. A diplexer can easily be purchased for this purpose (for example, Diplexer Model # DPL.26 or # DPL.313B from OML Inc., Morgan Hill CA)

The connection diagram for such a legacy mixer is:

Common Measurement Functions 1

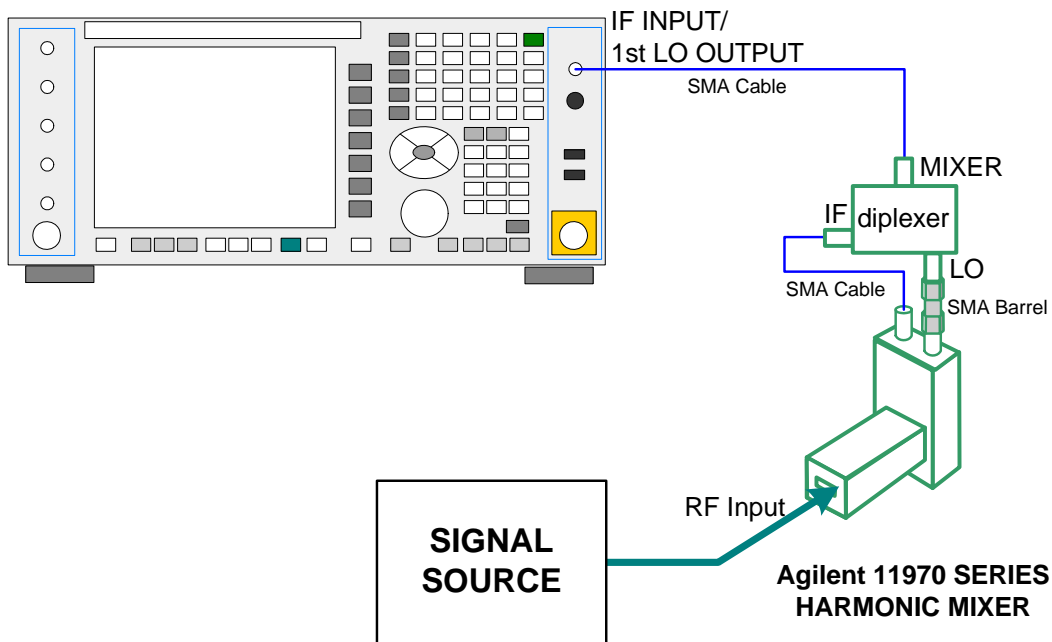

In addition, External Mixing in the X-Series supports the new Agilent M1970 series of Waveguide Harmonic Mixers, which provide a USB connection for download of calibration data and additional control.

The connection diagram for one of the Agilent USB mixers is:

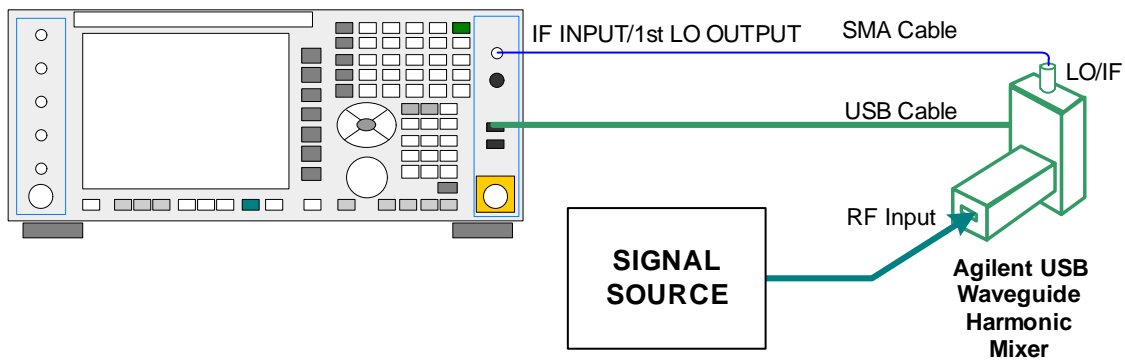

External Mixing is only supported in certain Modes and Measurements in the X-Series, as shown in the table below:

Mode	Measurements	Sig ID (Image Suppress only)
Spectrum Analyzer	Swept SA	Y*
	TOI	Y
	Harmonics	N
	Spurious Emissions	Y
	Channel Power	Y

Mode	Measurements	Sig ID (Image Suppress only)
	Occupied BW	Y
	ACP	Y
	Spectrum Emissions Mask	Y
	CCDF	N
	Burst Power	N
	List Sweep	N
Phase Noise	Monitor Spectrum	Y
	Log Plot	Y
	Spot Frequency	N
	Waveform	N
I/Q Analyzer	Complex Spectrum	N
	Waveform	N

- * the Swept SA measurement also supports Image Shift

Ext Mix Setup

This menu lets you select the mixer type, and lets you configure your mixer (if necessary). While in this menu, and any of its submenus, the External Mixer Setup screen appears, showing you the current settings for the selected mixer. These settings may be dependent on which IF path is currently in use, whether a + or – harmonic is currently selected, etc.

To apply any amplitude correction factors needed to correct mixer flatness, you enter values into one of the Correction tables (under Input/Output, Corrections). The correction conversion loss values can be extracted from data supplied with the mixer or from manual measurements you make to determine the conversion loss. Note that the correction applied by the Correction tables is global to the analyzer; therefore you should make sure to turn off the External Mixer corrections when you are not using the External Mixer input.

NOTE The Agilent USB Mixers automatically give their flatness data to the analyzer, and the correction is applied internally. No correction needs to be entered by the user, and the correction does not appear in the user-accessible Corrections tables. The user is free to enter additional corrections into the Correction tables under Input/Output, Corrections.

Key Path:	Input/Output, External Mixer
State Saved:	All settings in the Mixer Setup are part of the Input/Output system, and hence are saved whenever State is saved.

Common Measurement Functions 1

Readback Text:	The readback line on this key shows the currently selected mixer, in square brackets.
Initial S/W Revision:	A.08.01
Modified at S/W Revision:	A.08.50

The External Mixer Setup screen looks like this

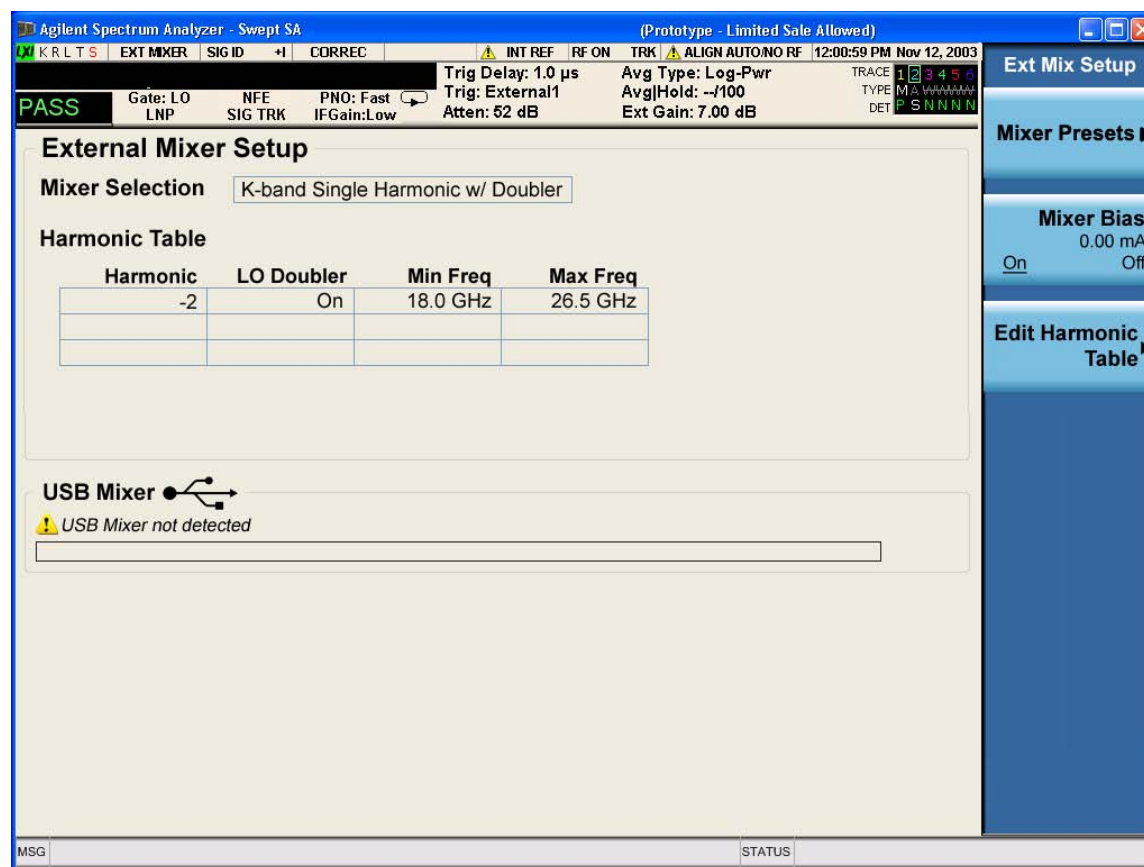

The current Mixer selection (the current or most recently connected USB Mixer, or the most recent Mixer Preset, or “Custom” if the user has modified the setup) reads out at the top of this screen.

The Harmonic Table currently being used reads out below the Mixer Selection. It shows each range being used for the current mixer. Note that a band may be made up of up to 3 ranges. Each range represents a choice of mixer harmonic and doubler state. When you select a Mixer Preset, it sets the analyzer Start and Stop frequency to the values shown in the Harmonic Table; Start Freq is set to the Min Freq for the bottom range, and Stop Freq is set to the Max Freq for the top range. In many cases you can exceed these nominal values; the absolute maximum and minimum frequency for each preset are shown in the tables that accompany the key descriptions for the Mixer Presets.

NOTE

If the current measurement has a limited Span available to it, and cannot achieve the Span shown in the table (Span=Stop Freq – Start Freq), the analyzer uses the maximum Span the measurement allows, and sets the Center Freq to the midpoint

of the Start and Stop Freq values in the Harmonic Table.

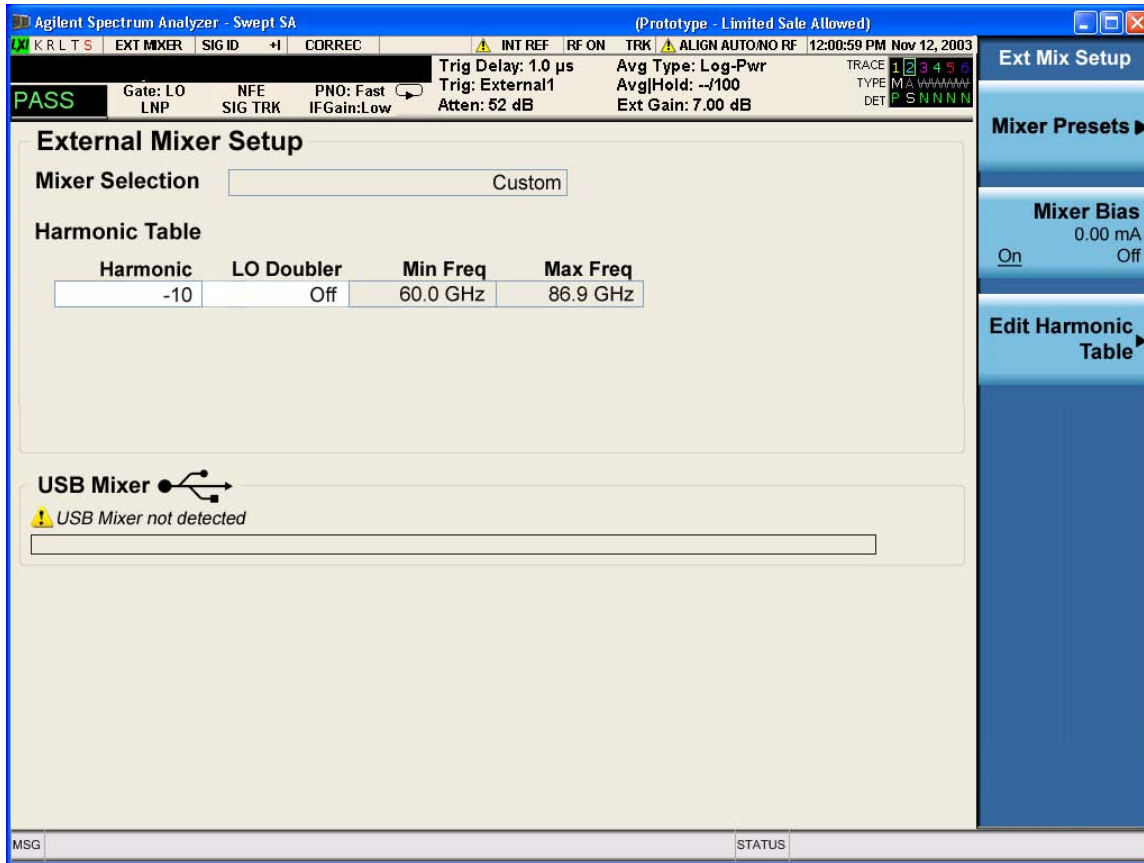

You may customize the Harmonic Table, but when you do this the analyzer goes into “single harmonic” mode. You may enter the harmonic number and whether to use the doubler or not, but now range switching is not supported, so you can only have one harmonic.

When you edit the Harmonic Table, the Mixer Selection changes to “Custom.” To change it back you must go back into the Mixer Presets menu and select a Preset.

When you edit the Harmonic Table, the nominal Min Freq and Max Freq that are available will usually be different than the Preset you were using; and the absolute frequency limits will change as well. This may result in a change to your Start and/or Stop Freq, if the current values fall outside the new range, requiring you to retune your Center Freq to get your signal back in the center.

The analyzer supports the new Agilent M1970 Series Waveguide Harmonic Mixers with USB connection. While in External Mixing, if one of these mixers is plugged in to a USB port, it is automatically detected and displayed in the “USB Mixer” area of the setup screen, including its model number and serial number. As long as it is connected to the USB, the analyzer assumes that this is the mixer you want to use.

The analyzer assumes that if you plug a mixer into the USB, that is the mixer you want to use. Therefore:

If a USB mixer is connected to the USB port, the Mixer Presets menu is grayed out, as none of the presets make sense with a USB Mixer connected. Note that once the analyzer has acquired the USB Mixer, the mixer selection will remain if it is subsequently unplugged from the USB, allowing you to

Common Measurement Functions 1

plug it back in with no change to your settings. However, once you unplug it, the Mixer Presets key will stop being grayed out, allowing you to preset to a different mixer.

When **Restore Input/Output Defaults** is performed, if an Agilent USB Mixer is plugged into the analyzer's USB port, the Mixer Selection remains unchanged.

When recalling an instrument state, if an Agilent USB Mixer is plugged into the analyzer's USB port, and the Mixer Selection in the recalled state is for a USB Mixer which does not match the mixer that is currently plugged in, you will have to unplug your mixer and then plug it back in to get the analyzer to recognize your mixer.

As long as the selection in Ext Mixer Setup shows one of the USB mixers, both the **Mixer Bias** and **Edit Harmonic Table** keys will be grayed out.

Agilent Spectrum Analyzer - Swept SA (Prototype - Limited Sale Allowed) 12:00:59 PM Nov 12, 2003

Gate: LO NFE PNO: Fast Trig Delay: 1.0 μ s Avg Type: Log-Pwr
LNP SIG TRK IFGain:Low Trig: External1 Atten: 52 dB AvgHold: -/100
Ext Gain: 7.00 dB

External Mixer Setup

Mixer Selection

Harmonic Table

Harmonic	LO Doubler	Min Freq	Max Freq
-10	Off	60.0 GHz	86.9 GHz
-8	On	66.0 GHz	90.0 GHz

USB Mixer 

USB Mixer detected

Agilent: XXXXXX: Extended V Band Mixer: YYYY

MSG STATUS

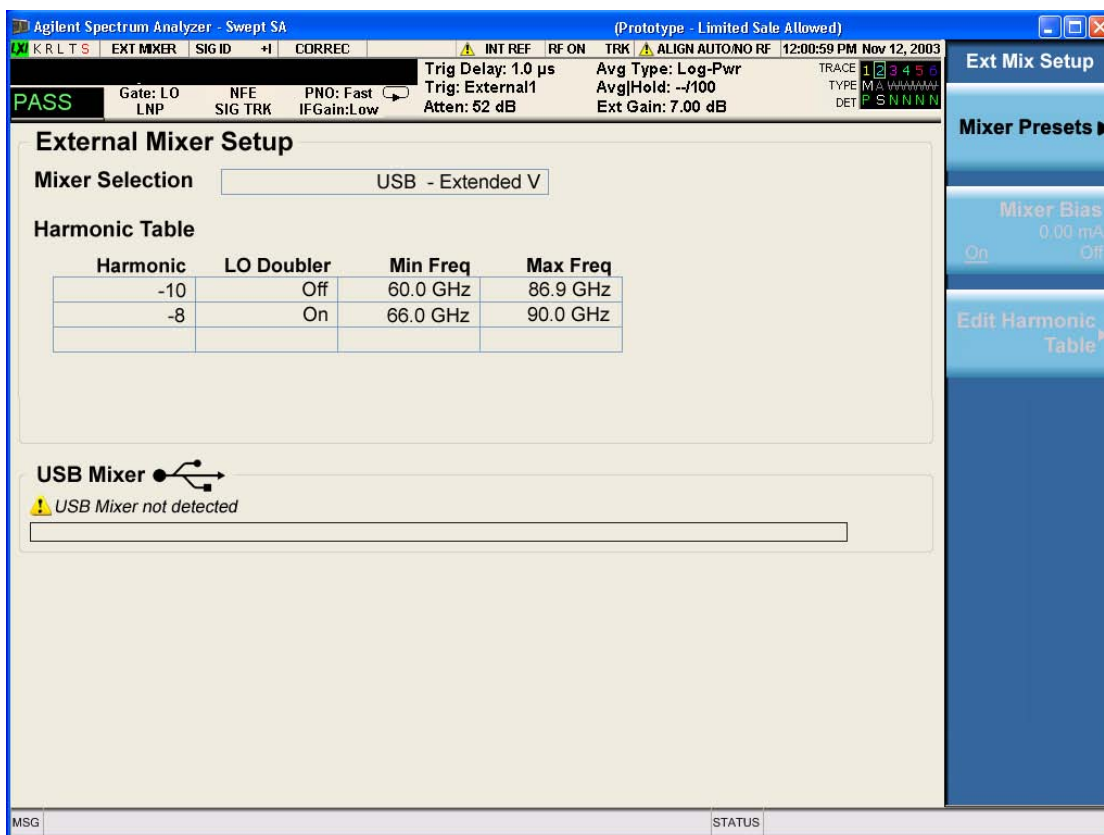

Only one USB Mixer is supported at a time. To switch to a different USB Mixer, disconnect the one that is no longer being used prior to connecting a new one.

The Mixer Selection displayed and softkey readback for the Agilent M1970 series mixers is:

Mixer Model	Mixer Selection display on Setup Screen	Readback on softkeys
Agilent M1970V Option 001: 50 to 75 GHz Waveguide Harmonic Mixer	USB - M1970V-001 V-Band	USB Mixer V-Band
Agilent M1970V Option 002: 50 to 80 GHz Waveguide Harmonic Mixer	USB - M1970V-002 Extended V-Band	USB Mixer Extended V
Agilent M1970W: 75 to 110 GHz Waveguide Harmonic Mixer	USB - M1970W W-Band	USB Mixer W-Band

Connecting the mixer to the USB port on the analyzer switches you to External Mixing, aborts the current measurement, and initiates an alignment of the mixer. A popup message, “USB Mixer connected” appears on the display. This message is removed once the alignment begins. When the alignment begins, an “Aligning” popup goes onto the display. When a USB mixer and the LO/IF cable are connected the alignment is performed. When the alignment completes, the current measurement restarts.

Common Measurement Functions 1

The Agilent USB mixer essentially acts as a “remote front end” and is fully calibrated over the specified frequency range, without user interaction required. This is particularly useful at high mm-wave frequencies, where cable loss is typically quite large, and it is desirable to bring the front end right up to the device under test, rather than bringing the mm-wave signal to the more bulky analyzer via a lossy and uncalibrated cable or waveguide connection.

Mixer Presets

This menu lets you preset the mixer setup for the particular type of mixer that you are using.

These presets are divided into four groups, one for Agilent legacy mixers, and three for general purpose mixers. Note that the IF/LO port provides 3.8–14 GHz LO in two bands: 3.8–8.7 (LO fundamental), and 8.6–14 GHz (doubled LO). The presets that use a single harmonic and no doubling are provided as one group of presets; presets that use a single harmonic but double the LO are another group; and presets that use multiple harmonics are a fourth group.

In most cases, once you have executed the preset, you will not need to adjust any further settings.

Key Path:	Input/Output, External Mixer, Ext Mix Setup
Remote Command:	[:SENSE] :MIXer :BAND A Q U V W NA ND NE NF NG NJ NK NQ NU NV NW NY NEXT DD D F DG DJ DK DQ DV DW DY DEXT MA ME MU MCOAX [:SENSE] :MIXer :BAND?
Example:	:MIX:BAND A :MIX:BAND?

<p>Notes:</p>	<p>A Q U V W select Agilent 11970 mixer presets</p> <p>NA ND NE NF NG NJ NK NQ NU NV NW NY NEXT select single harmonic, non-doubled LO presets</p> <p>DD DF DG DJ DK DQ DV DW DY DEXT select single harmonic, doubled LO presets</p> <p>MA ME MU MCOAX select multiple harmonic presets</p> <p>All of these presets are detailed in their respective key descriptions</p> <p>The query form of this command returns the most recent preset, UNLESS the harmonic table has been edited after the preset was executed. If the harmonic table has been edited it returns CUSTOM</p> <p>The query form of this command returns the following if an Agilent USB Mixer is plugged into the analyzer's USB port:</p> <p>USBV Agilent V-Band USB Mixer</p> <p>USBVEXT Agilent Extended V-Band USB Mixer</p> <p>USBWAgilent W-Band USB Mixer</p> <p>Note that the parameters CUSTOM, USBV, USBVEXT, and USBW are query responses only, and cannot be sent TO the analyzer.</p> <p>The following cross-reference matches the mixer band designators used by Agilent to the EIA waveguide designations:</p> <p>EIAAgilentFreq Range</p> <p>WR-28 A26.5 – 40 GHz</p> <p>WR-22 Q33 – 50 GHz</p> <p>WR-19 U40 – 60 GHz</p> <p>WR-15 V50 – 75 GHz</p> <p>WR-12 E60 – 90 GHz</p> <p>WR-10 W75 – 110 GHz</p> <p>WR-8 F90 – 140 GHz</p> <p>WR-6 D110 – 170 GHz</p> <p>WR-5 G140 – 220 GHz</p> <p>WR-3 J220 – 325 GHz</p>
<p>Preset:</p>	<p>When Restore Input/Output Defaults is performed, an "A" mixer preset is also issued (11970A band), unless an Agilent USB Mixer is plugged into the analyzer's USB port, in which case the Mixer Selection remains unchanged.</p>
<p>Backwards Compatibility Notes:</p>	<p>The [:SENSe]:MIXer:BAND command was used in PSA and ESA to select the mixer band. In the X-Series, only the legacy parameters A, Q, U, V, and W are honored, and they preset the analyzer to match the corresponding Agilent 11970 legacy mixer. Parameters D, E, F, G, J, K, Y, which were accepted in ESA and PSA, return an error if sent. If you are using a mixer in one of these bands, you should study the tables of presets and choose the appropriate preset to match your application. Also the USER parameter is no longer accepted, as the control model for mixer customization is very different in the X-Series.</p>
<p>Initial S/W Revision:</p>	<p>A.08.01</p>

Common Measurement Functions 1

Agilent 11970

This menu allows you to preset for one of the models in the HP/Agilent 11970 series.

Because the X-Series has an LO range of 3.8 – 14 GHz, and older analyzers had an LO range of 3.0 – 6.8 GHz, the harmonic numbers used in the X-Series may differ from those used on older analyzers for the same mixers. Additionally, some of the 11970 mixers cannot be operated over their full range with the X-Series without switching harmonics. Consequently, you will find that some of the bands (A-Band, for example) are broken into two ranges for use with the X-Series.

See [“More Information” on page 1440](#)

Key Path:	Input/Output, External Mixer, Ext Mix Setup, Mixer Presets
Example:	MIX:BAND A
Initial S/W Revision:	A.08.01

More Information

Below are the 11970A presets. The 11970U and the 11970W use a single harmonic. The other three switch harmonics mid-band. Both harmonic ranges are shown in the table. None of these mixers use LO doubling.

The 11970 K-band mixer and the 11974 preselected mixer series are not supported.

Preset	Readout in setup screen	Readback on softkeys	Range	Harm #	RF start	RF stop	RF center
A-band	Agilent 11970A	Agilent 11970A	1	-6	26.5	30.45	28.475
			2	-8	30.35	40	35.175
Q-band	Agilent 11970Q	Agilent 11970Q	1	-8	33	40.8	36.9
			2	-10	39.8	50	44.9
U-band	Agilent 11970U	Agilent 11970U	...	-10	40	60	50
V-band	Agilent 11970V	Agilent 11970V	1	-12	50	66	58
			2	-14	53	75	64
W-band	Agilent 11970W	Agilent 11970W	..	-18	75	110	92.5

Single Harmonic

These presets choose a setup that uses a single harmonic and no doubling for the LO.

Key Path:	Input/Output, External Mixer, Ext Mix Setup, Mixer Presets
Example:	MIX:BAND NA
Initial S/W Revision:	A.08.01

These are the presets for single harmonic operation with no doubler:

Mixer	Readout in setup screen	Readback on softkeys	Harm #	RF start	RF stop	RF center
K-band	K-band Single Harmonic, no doubler	Sngl harm LOx1 K-band	-4	18	26.5	22.25
A-band	A-band Single Harmonic, no doubler	Sngl harm LOx1 A-band	-6	26.5	40	33.25
D-band	D-band Single Harmonic, no doubler	Sngl harm LOx1 D-band	-20	110	170	140
E-band	E-band Single Harmonic, no doubler	Sngl harm LOx1 E-band	-12	60	90	75
F-band	F-band Single Harmonic, no doubler	Sngl harm LOx1 F-band	-18	90	140	115
Q-band	Q-band Single Harmonic, no doubler	Sngl harm LOx1 Q-band	-6	33	50	41.5
U-band	U-band Single Harmonic, no doubler	Sngl harm LOx1 U-band	-8	40	60	50
V-band	V-band Single Harmonic, no doubler	Sngl harm LOx1 V-band	-10	50	75	62.5
W-band	W-band Single Harmonic, no doubler	Sngl harm LOx1 W-band	-14	75	110	92.5
G-band	G-band Single Harmonic, no doubler	Sngl harm LOx1 G-band	-26	140	220	180
Y-band	Y-band Single Harmonic, no doubler	Sngl harm LOx1 Y-band	-30	170	260	215
J-band	J-band Single Harmonic, no doubler	Sngl harm LOx1 J-band	-38	220	325	272.5
Extended	Extended Single Harmonic, no doubler	Sngl harm LOx1 Extended	-40	155	345	250

Common Measurement Functions 1

Single Harmonic w/doubler

These presets choose a setup that uses a single harmonic and no doubling for the LO.

Key Path:	Input/Output, External Mixer, Ext Mix Setup, Mixer Presets
Example:	MIX:BAND DW
Initial S/W Revision:	A.08.01

These are the presets for single harmonic operation with no doubler:

Mixer	Readout in setup screen	Readback on softkeys	Harm #	RF start	RF stop	RF center
D-band	D-band Single Harmonic w/doubler	Sngl harm LOx2 K-band	-14	110	170	140
F-band	F-band Single Harmonic w/doubler	Sngl harm LOx2 A-band	-10	90	140	115
G-band	G-band Single Harmonic w/doubler	Sngl harm LOx2 A-band	-16	140	220	180
J-band	J-band Single Harmonic w/doubler	Sngl harm LOx2 A-band	-24	220	325	272.5
K-band	K-band Single Harmonic w/doubler	Sngl harm LOx2 A-band	-2	18	26.5	22.25
Q-band	Q-band Single Harmonic w/doubler	Sngl harm LOx2 A-band	-4	33	50	41.5
V-band	V-band Single Harmonic w/doubler	Sngl harm LOx2 A-band	-6	50	75	62.5
W-band	W-band Single Harmonic w/doubler	Sngl harm LOx2 A-band	-8	75	110	92.5
Y-band	Y-band Single Harmonic w/doubler	Sngl harm LOx2 A-band	-20	170	260	215
Extended	Extended Single Harmonic w/doubler	Sngl harm LOx2 A-band	-28	245	390	317.5

Multiple Harmonics

These presets choose a setup that uses multiple harmonics and may or may not use doubling for the LO.

Key Path:	Input/Output, External Mixer, Ext Mix Setup, Mixer Presets
Example:	MIX:BAND MA
Initial S/W Revision:	A.08.01

These are the presets for multiple harmonic operation:

Mixer	Readout in setup screen	Readback on softkeys	Range	Harm #	Dblr ?	RF start	RF stop	RF Center
A-band	A-band Multiple Harmonic	Multi harm A-band	1	-4	N	26.5	34.1	30.3
			2	-4	Y	33.1	40	36.55
E-band	E-band Multiple Harmonic	Multi harm E-band	1	-6	Y	60	83	71.5
			2	-8	Y	65	90	77.5
U-band	U-band Multiple Harmonic	Multi harm U-band	1	-6	N	40	51.5	45.75
			2	-6	Y	49.5	60	54.75
Coaxial	Coaxial Multiple Harmonic	Multi harm Coaxial	1	-4	N	26.5	34	30.25
			2	-4	Y	32.5	55	43.75
			3	-6	Y	50	70	60

Mixer Bias

Adjusts an internal bias source for use with external mixers. The bias signal is present on the center conductor of the IF input connector on the front panel. The shunt current range is from -10 mA to 10 mA and it can be set whether Mixer Bias state is On or Off, but it will only be applied if it is On.

The bias remains as set if the user switches to another input (e.g., the RF Input).

Key Path:	Input/Output, External Mixer, Ext Mix Setup
Remote Command:	<pre>[:SENSe]:MIXer:BIAS <real> [:SENSe]:MIXer:BIAS? [:SENSe]:MIXer:BIAS:STATE OFF ON 0 1 [:SENSe]:MIXer:BIAS:STATE?</pre>
Example:	<pre>:MIX:BIAS 0 :MIX:BIAS? MIX:BIAS:STAT 0 MIX:BIAS:STAT?</pre>

Common Measurement Functions 1

Preset:	This is unaffected by Preset but is set to OFF and 0 on a "Restore Input/Output Defaults"
State Saved:	Saved in state
Min:	-10 mA
Max:	10 mA
Initial S/W Revision:	A.08.01

Edit Harmonic Table

This menu lets you directly configure the Harmonic number and LO Doubler state of your mixer by editing the Harmonic Table. The Harmonic Table can be configured as either a single row (meaning only one harmonic number is used and the LO Doubler is either on or off), two rows where the harmonic number switches between the first row and the second, or two rows where the LO Doubler state switches between the first row and the second.

When you press the Edit Harmonic Table softkey, a dialog pops up on the display informing you that when you edit the Harmonic Table you will go into Custom mixer mode, and that to undo your changes you must go to the Mixer Presets menu and choose the preset appropriate for your mixer. You may cancel out of this dialog and not enter the Edit Harmonic Table menu. If you choose to enter the menu, the Mixer Selection changes to "Custom".

In Custom mode, your maximum start and stop frequencies are strictly set by the LO range and the harmonic number you have chosen. The undoubled LO range is approximately 3.8 – 8.7 GHz, and (for LO's that support doubling) the doubled range is approximately 8.0 – 14.0 GHz. That range times the harmonic you have selected will determine your tuning range. If your frequency is currently outside that range when you edit the Harmonic Table, your frequency will be changed to fall at the edge of the range. To change it back you must go into the Mixer Presets menu and select a Preset.

Whenever you are in the **Edit Harmonic Table** menu, the editable fields in the table have a white background, indicating that they can be edited. These fields vary depending on the Table Type. For the Single Row Table Type, both the Harmonic and LO Doubler cells are white. For Harmonic Switching both the Harmonic and LO Doubler cells are white, but only in the first row, as only the first row can be edited. For Doubler Switching, only the Harmonics cell in the first row is white, as this is the only cell you can edit.

Note that you cannot add or delete rows from the table; you can only modify the rows that are already there.

Key Path:	Input/Output, External Mixer, Ext Mix Setup
Initial S/W Revision:	A.08.01
Modified at S/W Revision:	A.10.01

Table Type

This parameter determines which type of configuration you want the Custom Mixer to be. You can choose Single Row, Harmonic Switching, or Doubler Switching. See detail under each of these keys.

Key Path:	Input/Output, External Mixer, Ext Mix Setup, Edit Harmonic Table
Remote Command:	[:SENSE]:MIXer:TTYPe SINGLE HARMonic DOUbler [:SENSE]:MIXer:TTYPe?
Example:	:MIX:TTYP SING

Couplings:	When you change the Table Type, the Mixer Selection changes to “Custom”
Preset:	Depends on the current Mixer Preset. This is unaffected by Mode Preset, but on a "Restore Input/Output Defaults" the Mixer is preset to 11970A, for which the Table Type is Harmonic Switching
State Saved:	Saved in State
Initial S/W Revision:	A.10.01

Single Row

In the Single Row type, the External Mixer always stays in the same Harmonic Number and the LO Doubler is either on or off and does not change state during a sweep. You may change the Harmonic Number and you may change the state of the Doubler.

Key Path:	Input/Output, External Mixer, Ext Mix Setup, Edit Harmonic Table, Table Type
Example:	:MIX:TTYP SING
State Saved:	Saved in State
Initial S/W Revision:	A.10.01

Harmonic Switching

In the Harmonic Switching type, the External Mixer switches Harmonic Number in the middle of the sweep. The Lo Doubler may be on or off but it is the same for both Harmonic Numbers. You can set the initial Harmonic Number, and when it switches it decrements by two when the harmonic is negative and increments by two when the harmonic is positive. For example, if you set the initial number to -6, when it switches it will go to -8. If you set the harmonic number to 8 when it switches it will go to 10.

Key Path:	Input/Output, External Mixer, Ext Mix Setup, Edit Harmonic Table, Table Type
Example:	:MIX:TTYP HARM
State Saved:	Saved in State
Initial S/W Revision:	A.10.01

Doubler Switching

In the Doubler Switching type, the External Mixer switches the doubler from Off to On in the middle of the sweep. You can set the Harmonic Number but it stays the same for the Doubler Off state as for the Doubler On state. The LO Doubler key is grayed out in this table type.

Key Path:	Input/Output, External Mixer, Ext Mix Setup, Edit Harmonic Table, Table Type
Example:	:MIX:TTYP DOUB
State Saved:	Saved in State
Initial S/W Revision:	A.10.01

Common Measurement Functions 1

Harmonic

This lets you enter the Harmonic value with its associated sign (mixing mode).

The harmonic number is a signed integer, where the sign has the meaning of choosing between positive and negative mixing products. Desired mixing products occur at an IF frequency which equals the difference between the RF frequency (f_{RF}) and the LO frequency (Nf_{LO}). When this difference is positive, we can say $f_{IF} = f_{RF} - Nf_{LO}$. When this difference is negative, we can say $f_{IF} = Nf_{LO} - f_{RF}$. Thus, a negative harmonic means the analyzer will be tuned such that the harmonic of the LO is higher than the indicated frequency by the frequency of the first IF. A positive harmonic means the analyzer will be tuned such that the harmonic of the LO is lower than the indicated frequency by the frequency of the first IF.

Key Path:	Input/Output, External Mixer, Ext Mix Setup, Edit Harmonic Table
Remote Command:	[:SENSE]:MIXer:HARMonic <integer> [:SENSE]:MIXer:HARMonic?
Example:	:MIX:HARM -28 :MIX:HARM?
Notes:	The query returns the harmonic value of the first row of the harmonic table.
Couplings:	When you set a value for the Harmonic via SCPI, the Mixer Selection changes to "Custom"
Preset:	This is unaffected by Mode Preset, but on a "Restore Input/Output Defaults" editing is turned off, the Harmonic Table returns to normal, and the Mixer is preset to 11970A, which has -6 in the first row of its Harmonic Table
State Saved:	Saved in State
Min:	-400
Max:	400
Initial S/W Revision:	A.08.01
Modified at S/W Revision:	A.10.01

LO Doubler

This lets you enter the LO Doubler setting. The LO Doubler setting controls the choice of the LO doubler state for LO's which support doubled operation.

In LO's which support doubling, the fundamental band is approximately 3.8 – 8.7 GHz, and the doubled band is approximately 8.0 – 14 GHz. The higher LO frequency can result in a lower mixer harmonic and reduced mixer conversion loss.

Key Path:	Input/Output, External Mixer, Ext Mix Setup, Edit Harmonic Table
Remote Command:	[:SENSE]:MIXer:LODoubler ON OFF 0 1 [:SENSE]:MIXer:LODoubler?
Example:	:MIX:LOD 0 :MIX:LOD?

Notes:	The query returns the doubler value of the first row of the harmonic table.
Dependencies:	This key is grayed out and set to Off when Table Type is set to Doubler Switching.
Couplings:	When you set a value for the doubler setting via SCPI, the Mixer Selection changes to "Custom"
Preset:	This is unaffected by Mode Preset, but on a "Restore Input/Output Defaults" editing is turned off, the Harmonic Table returns to normal, and the Mixer is preset to 11970A, which has the doubler Off in the first row of its Harmonic Table
State Saved:	Saved in state
Initial S/W Revision:	A.08.01
Modified at S/W Revision:	A.10.01

Signal ID On/Off

Activates or deactivates an algorithm which aids with the identification of multiple responses

Toggles the Signal ID (signal identification) function On or Off. This function lets you identify multiple responses of a single input signal that are generated when using un-preselected external mixers. The use of mixers without pre-selecting filters offers the advantage of improved receiver sensitivity because of the absence of the filter insertion loss, but results in multiple responses due to images and undesired harmonic mixing products.

While in Signal ID, basic spectrum analyzer functions work normally (for example, you can change Span normally) but some functions are disabled (for example, some traces are unavailable).

There are two forms of Signal ID, Image Suppress and Image Shift. Choose the one most appropriate for your application. For Image Shift, an LO-shifted and an unshifted trace are taken in Trace 1 and Trace 2 and displayed together. Any peaks that are not the same in both traces are images. For Image Suppress, image cancellation is performed in the background using two hidden traces, and the result displayed in Trace 1, which shows only the valid signals.

Key Path:	Input/Output, External Mixer
Remote Command:	[:SENSE] :SIDentify [:STATe] OFF ON 0 1 [:SENSE] :SIDentify [:STATe] ?
Example:	:SID 0 :SID?
Notes:	Signal ID uses data from two successive sweeps. Therefore, if the analyzer is in single sweep mode, two sweep triggers are used to generate the data needed for signal identification.

Common Measurement Functions 1

Dependencies:	<p>Signal ID is not available in some measurements. If the Signal ID key does not appear or is grayed out while in your measurement, then it is not available.</p> <p>Because Signal ID uses data from two successive sweeps, several trace and sweep functions are grayed out in Signal ID. See the documentation for your measurement for details on which trace keys are grayed out.</p> <p>Signal ID is not available with Signal Track so Signal ID will be grayed out if in Signal Track. Message:</p> <p>Signal ID will be turned off when External Mixer is turned off. Signal ID cannot be turned on when using internal mixing.</p> <p>Rules for auto coupling of the Sweep and FFT keys are changed with Signal ID on. For both the dynamic range case and the speed case, swept is chosen whenever any form of Signal ID is on. If Manual FFT is selected, the Signal ID key is grayed out.</p> <p>Whenever Signal ID is on, a warning message will be generated</p> <p>If Signal ID is selected in a measurement that does not support it, a warning message is generated</p>
Couplings:	The Auto Rules for detector selection select Normal for all active traces when Signal ID is turned on.
Preset:	This is unaffected by Preset but is set to OFF on a "Restore Input/Output Defaults"
Initial S/W Revision:	A.08.01

Signal ID Mode

Let you set which Signal ID mode you will use, either Image Suppress or Image Shift.

Key Path:	Input/Output, External Mixer
Remote Command:	[:SENSE]:SIDentify:MODE ISUPpress IShift [:SENSE]:SIDentify:MODE?
Example:	:SID:MODE ISUP :SID:MODE?
Preset:	This is unaffected by Preset but is set to ISUPpress on a "Restore Input/Output Defaults"
State Saved:	Saved in state
Initial S/W Revision:	A.08.01

Image Suppress

The Image Suppress mode of Signal ID mathematically removes all image and multiple responses of signals present at the mixer input. Two hidden sweeps are taken in succession. The second sweep is offset in LO frequency by $2*IF/N$. For each point in each trace, the smaller amplitude from the two traces is taken and placed in that point in Trace 1. Responses of each trace that lie on top of one another will remain and are valid signals, others are images and are suppressed. The action of taking the smaller of the two traces will make the average noise level

lower in all points that do not have an image, thus reducing the accuracy of the measurement of noise and noise-like signals.

NOTE This function takes control of and uses Trace 1 and Trace 2. Any data in these traces prior to activating Image Suppress will be lost.

Key Path:	Input/Output, External Mixer, Signal ID Mode
Example:	:SID:MODE ISUP
Notes:	In Image Suppress Mode, synchronization is ensured by first turning off Signal ID, initiating a single sweep, then turning on Signal ID followed by two single sweeps.
Couplings:	In Image Suppress the Peak detector is auto-selected to improve the image suppression effectiveness.
Initial S/W Revision:	A.08.01
Modified at S/W Revision:	A.10.01

Image Shift

Like the Image Suppress mode, Image Shift is a two sweep sequence. The data from the first sweep is placed in Trace 1 and the data from the second (LO frequency shifted by $2*IF/N$) sweep is placed in Trace 2. On alternate sweeps, the alternate trace (trace 2) is placed in front of trace 1. This way, you can see a signal at the same place on alternate sweeps, showing in yellow (trace1) and blue (trace2). Signal responses of Trace 1 and Trace 2 that have the same horizontal position are considered to be in the current band and therefore can be analyzed with the amplitude and frequency measurement systems of the SA. All other responses are invalid and should be ignored.

NOTE This function takes control of and uses Trace 1 and Trace 2. Any data in these traces prior to activating Image Shift will be lost.

Key Path:	Input/Output, External Mixer, Signal ID Mode
Example:	:SID:MODE ISH
Notes:	To synchronize in Image Shift Mode, turn off Signal ID and then initiate a single sweep. Then turn on Signal ID and initiate two single sweeps. The results of the first sweep after Signal ID is turned on are available in Trace 1. The next sweep is shifted and the data from that sweep is available in Trace 2. The unshifted and shifted data can then be compared.
Couplings:	Trace 2 is turned off when Image Shift is turned Off.
Initial S/W Revision:	A.08.01

Common Measurement Functions 1

Cable IF Loss

The loss at the IF in the IF/LO cable can be compensated for with this function, by entering the loss in dB for your cable.

The cable loss will depend on the IF frequency. The IF frequency varies depending on which IF path your measurement is using. For best accuracy, characterize your cable's loss for the IF frequency or frequencies you will be using.

IF Frequencies:

10 MHz path: 322.5 MHz

25 MHz path: 322.5 MHz

40 MHz path: 250 MHz

140 MHz path: 300 MHz

Key Path:	Input/Output, External Mixer
Key Path:	Input/Output, External Mixer, Calibrate Mixer
Remote Command:	[:SENSE]:MIXer:CIFLoss <rel_ampl> [:SENSE]:MIXer:CIFLoss?
Example:	:MIX:CIFL 0.23 DB :MIX:CIFL?
Preset:	0.26 dB
State Saved:	Saved in state
Min:	-100
Max:	100
Initial S/W Revision:	A.08.01

I/Q

This feature is not available unless the “[Baseband I/Q \(Option BBA\)](#)” on page 1451 is installed.

Selects the front-panel I/Q input ports to be the analyzer signal input. If I/Q is already selected, pressing this key accesses the I/Q setup menu.

Key Path:	Input/Output
Mode:	BASIC, CDMA2K, EDGE GSM, TDSCMDA, VSA89601, WIMAX OFDMA
Example:	FEED AIQ
Notes:	Not all measurements support the use of the I/Q signal input. When I/Q is selected in a measurement that does not support it, the “No Result; Meas invalid with I/Q inputs” error condition message appears. This is error 135
Initial S/W Revision:	Prior to A.02.00

Baseband I/Q (Option BBA)

The Baseband I/Q functionality is a hardware option. It is option BBA. If the option is not installed, none of the I/Q functionality is enabled.

The Baseband I/Q has four input ports and one output port. The input ports are I, I-bar, Q, and Q-bar. The I and I-bar together compose the I channel and the Q and Q-bar together compose the Q channel. Each channel has two modes of operation, Single-Ended (also called "unbalanced") and Differential Input (also called "balanced"). When in Single-Ended operation, only the main port (I or Q) is used and the complementary port (I-bar or Q-bar) is ignored. When in Differential Input mode, both main and complementary ports are used.

The input settings (range, attenuation, skew, impedance, external gain) apply to the channels, not the individual ports.

The system supports a variety of 1 M Ω input passive probes as well as the Agilent 113x Series active differential probes using the Infinimax probe interface.

The Agilent 113x Series active probes can be used for both single ended and differential measurements. In either case a single connection is made for each channel (on either the I or Q input). The input is automatically configured to 50 Ω single ended and the probe power is supplied through the Infinimax interface. The probe can be configured for a variety of input coupling and low frequency rejection modes. In addition, a wide range of offset voltages and probe attenuation accessories are supported at the probe interface. The active probe has the advantage that it does not significantly load the circuit under test, even with unity gain probing.

With passive 1 M Ω probes, the probe will introduce a capacitive load on the circuit, unless higher attenuation is used at the probe interface. Higher attenuation reduces the signal level and degrades the signal-to-noise-ratio of the measurement. Passive probes are available with a variety of attenuation values for a moderate cost. Most Agilent passive probes can be automatically identified by the system, setting the input impedance setting required as well as the nominal attenuation. For single ended measurements a single probe is used for each channel. Other passive probes can be used, with the attenuation and impedance settings configured manually.

For full differential measurements, the system supports probes on each of the four inputs. The attenuation of the probes should be the same for good common mode rejection and channel match.

Both active and passive probes in single ended and differential configurations can be calibrated. This calibration uses the Cal Out BNC connection and a probe connection accessory. The calibration achieves excellent absolute gain flatness in a probed measurement. It matches both the gain and frequency response of the I and Q channels as well as any delay skew, resulting in high accuracy in derived measurements such as Error Vector Magnitude (EVM).

When a probe is connected a status message will be displayed. The message will indicate if calibration data is available or not. Calibration data is saved for each type of probe (including "none") for each port and will be reapplied whenever that type of probe is re-connected to the same port. For probes with EEPROM identification, the calibration data will be stored based on the unique probe identifier and will reapply data for that particular probe if it is available. The data will not follow a probe from one port to another. For probes without EEPROM identification, the instrument cannot distinguish between different probes of the same type and it will use the data from the last calibration for that probe type on that port.

When in differential mode, both the main and complementary probes are expected to be of the same type.

Common Measurement Functions 1

In some situations, the I and Q channels should be configured identically. In other situations it is convenient to control them independently. Some menus have a "Q Same as I" setting that will cause the Q channel configuration to mirror the I channel configuration, avoiding the overhead of double data entry when the channels should be the same.

The output port is for calibrating the I/Q input ports, although it can also be manually controlled.

There are two types of calibrations available: cable calibration and probe calibration. The cable calibration will guide the user through connecting each input port in turn. All ports must be calibrated together. The probe calibration is done for a specific channel (I or Q). If in Single-Ended mode, only the main port is calibrated. When in Differential Input mode, the user is guided through calibrating both main and complementary ports.

The front panel I/Q port LEDs indicate the current state of that port. On (green) indicates it is active, and off (dark) indicates it is not in use. For example, the Cal Out port LED is on if and only if there is signal coming out of that port.

The input is a context and some parameters have separate values for each context. The SCPI for these parameters has an optional "[:RF|IQ]" node. If the specific context is omitted, the command acts on the current input context's value. Here are the parameters that are input context sensitive:

- Center Frequency
- Trigger Source

It is important to distinguish between the I and Q input ports and the displayed I and Q data values. The I and Q input ports feed into a digital receiver that does digital tuning and filtering. The I and Q data seen by the user (either on the display or through SCPI) corresponds to the real ("I") and the imaginary ("Q") output from the digital receiver. When the input path is I+jQ or I Only and the center frequency is 0 Hz the I input ends up in as the real output from the receiver and appears as "I" data. Likewise, when the input path is I+jQ and the center frequency is 0 Hz, the Q input ends up as the imaginary output from the receiver and appears as "Q" data. However, when the input path is Q Only, the Q input is sent to the receiver as Q+j0, so the receiver output has the Q input coming out on the real output, and so in Q Only, the signal from the Q input port appears as the "I" data. Another situation where the I and Q data do not necessarily correspond directly to the I and Q inputs is when the center frequency is non-zero. The digital processing involved in the tuning is a complex operation. This will result in I Only data appearing as both "I" and "Q" data, the same as that signal would appear if seen through the RF input port.

Baseband I/Q Remote Language Compatibility

For the Agilent E4406A VSA Series Transmitter Tester, Option B7C provided baseband I/Q inputs. Code compatibility has been provided to allow many of the commands for option B7C to function properly with the X-Series. The X-Series has hardware differences and additional capabilities (e.g., E4406A does not have independent settings of I & Q nor does it provide for probe calibrations) which make 100% compatibility impossible.

The following commands are supported:

`:CALibration:IQ:FLATness`

`:INPut:IMPedance:IQ U50|B50|U1M|B1M`

`:INPut:IMPedance:REFerence <integer>`

The `[:SENSe]:FEED RF|IQ|IONLy|QONLy|AREFerence|IFALign` command supports all parameters

except IFALign. The FEED? query will return only RF|AIQ|AREF.

The following commands are not supported:

:CALibration:GIQ

:CALibration:IQ:CMR

:INPut:IQ:ALIGn OFF|ON|0|1

The Rohde & Schwarz FSQ-B71 also provides baseband I/Q inputs. A certain amount of code compatibility is provided in the X-Series, however hardware differences make this a somewhat limited set.

Supported:

The "<1|2>" is supported as "[1]".

INPut<1|2>:IQ:BALanced[:STATe] ON | OFF

INPut<1|2>:IQ:TYPE I | Q | IQ

INPut<1|2>:IQ:IMPedance LOW | HIGH

Not Supported:

INPut<1|2>:SElect AIQ | RF

TRACe<1|2>:IQ:DATA:FORMat COMPatible | IQBLock | IQPair>

TRACe<1|2>:IQ:DATA:MEMory? <offset samples>,<# of samples>

TRACe<1|2>:IQ:DATA?

TRACe<1|2>:IQ:SET <filter type>,<rbw>,<sample rate>,<trigger source>,<trigger slope>,<pretrigger samples>,<# of samples>

TRACe<1|2>:IQ:SRATe 10.0kHz to 81.6MHz

TRACe<1|2>:IQ[:STATe] ON|OFF

The Rohde & Schwarz FMU has the following SCPI which is not supported (these commands start/abort the probe calibration procedure, which is manually interactive from the front panel):

CALibration:ABORt

CALibration:PROBe[:STARt]

I/Q Path

Selects which I/Q input channels are active. The LED next to each I/Q input port will be on when that port is active.

The analysis bandwidth for each channel is the same as that of the instrument. So, for example, the base N9020A has a bandwidth of 10 MHz. With I/Q input the I and Q channels would each have an analysis bandwidth of 10 MHz, giving 20 MHz of bandwidth when the I/Q Path is I+jQ. With option B25, the available bandwidth becomes 25 MHz, giving 25 MHz each to I and Q and 50 MHz to I+jQ.

I/Q voltage to power conversion processing is dependent on the I/Q Path selected.

Common Measurement Functions 1

- With I+jQ input we know that the input signal may not be symmetrical about 0 Hz, because it has a complex component. Therefore, above 0 Hz only the positive frequency information is displayed, and below 0 Hz only the negative frequency information is displayed.
- With all other Input Path selections, the input signal has no complex component and therefore is always symmetrical about 0 Hz. In this case, by convention, the power conversion shows the combined voltage for both the positive and negative frequencies. The information displayed below 0 Hz is the mirror of the information displayed above 0 Hz. This results in a power reading 6.02 dB higher (for both) than would be seen with only the positive frequency voltage. Note also that, in this case the real signal may have complex modulation embedded in it, but that must be recovered by further signal processing.

Key Path:	Input/Output, I/Q
Remote Command:	[:SENSE] :FEED:IQ:TYPE IQ IONLY QONLY INdependent [:SENSE] :FEED:IQ:TYPE?
Example:	Set the input to be both the I and Q channels, combined as $I + j * Q$. FEED:IQ:TYPE IQ
Notes:	The Independent I and Q selection is only available in GPVSA
Preset:	IQ
State Saved:	Yes This is unaffected by a Preset but is set to the default value on a "Restore Input/Output Defaults" or "Restore System Defaults->All"
Range:	I+jQ I Only Q Only Independent I and Q
Readback Text:	I+jQ I Only Q Only Ind I/Q
Initial S/W Revision:	Prior to A.02.00

Remote Command:	: INPut [1] : IQ : TYPE IQ I Q : INPut [1] : IQ : TYPE?
Notes:	For R&S FSQ-B71 compatibility
Preset:	IQ
Initial S/W Revision:	Prior to A.02.00

I+jQ

Sets the signal input to be both the I and Q channels. The I and Q channel data will be combined as $I + j * Q$.

Key Path:	Input/Output, I/Q, I/Q Path
Example:	Set the input to be both the I and Q channels, combined as $I + j * Q$. FEED:IQ:TYPE IQ

Initial S/W Revision:	Prior to A.02.00
-----------------------	------------------

I Only

Sets the signal input to be only the I channel. The Q channel will be ignored. The data collected is still complex. When the center frequency is 0 the imaginary part will always be zero, but for any other center frequency both the real and imaginary parts will be significant.

Key Path:	Input/Output, I/Q, I/Q Path
Example:	Set the input to be only the I channel. FEED:IQ:TYPE IONL
Initial S/W Revision:	Prior to A.02.00

Q Only

Sets the signal input to be only the Q channel. The I channel will be ignored. The Q channel will be sent to the digital receiver block as $Q+j0$. The receiver's output is still complex. When the center frequency is 0 the imaginary part will always be zero, but for any other center frequency both the real and imaginary parts will be significant. Note that since the receiver's real output is displayed as the "I" data, when the center frequency is 0, the Q Only input appears as the "I" data.

Key Path:	Input/Output, I/Q, I/Q Path
Example:	Set the input to be only the Q channel. FEED:IQ:TYPE QONL
Initial S/W Revision:	Prior to A.02.00

Independent I and Q

Sets the signal input to be both the I and Q channels, but as independent inputs. It is equivalent to treating I as channel 1 and Q as channel 2 in an oscilloscope. Each channel's data is still complex. When the center frequency is 0 the imaginary part will always be zero, but for any other center frequency both the real and imaginary parts will be significant.

This selection is only available in VXA.

Key Path:	Input/Output, I/Q, I/Q Path
Example:	Turn on both I and Q channels and treat I as channel 1 and Q as channel 2. FEED:IQ:TYPE IND
Notes:	The Independent I and Q selection is only available in GPVSA
Readback Text:	Ind I/Q
Initial S/W Revision:	Prior to A.02.00

Common Measurement Functions 1

I Setup

Access the channel setup parameters for the I channel.

Key Path:	Input/Output, I/Q
Initial S/W Revision:	Prior to A.02.00

I Differential Input

Selects differential input on or off for the I channel. For differential input (also called balanced input), the analyzer uses both main and complementary ports. When differential input is off (also called single-ended or unbalanced input), the analyzer uses only the main port.

Key Path:	Input/Output, I/Q, I Setup
Remote Command:	:INPut:IQ[:I]:DIFFerential OFF ON 0 1 :INPut:IQ[:I]:DIFFerential?
Example:	Put the I channel in Differential Input mode INP:IQ:DIFF ON
Notes:	When I Differential Input = On, the analyzer will check for attenuation mismatches between the I and I-bar ports. If the difference in attenuation values exceeds 0.5 dB a Settings Alert error condition, error 159 will be set. When I Differential Input = On, and IQ Path is I+jQ, the Q Differential input must also be On. Similarly, when I Differential Input = Off, and IQ Path is I+jQ, the Q Differential input must also be Off. If the states of the two inputs do not match, an error condition message is generated, 159;Settings Alert;I/Q mismatch:Differential.
Couplings:	Some active probes include built-in differential capability. When one of these probes is sensed, this key is disabled. Since the differential capability is handled in the probe, the Analyzer will use only the main port and the key will show that the Analyzer's Differential Input mode is Off (indicating that the complementary port not in use). When Q Same as I is On, the value set for I will also be copied to Q.
Preset:	Off
State Saved:	Yes This is unaffected by a Preset but is set to the default value on a "Restore Input/Output Defaults" or "Restore System Defaults->All"
Range:	Off On
Initial S/W Revision:	Prior to A.02.00

Remote Command:	:INPut[1]:IQ:BALanced[:STATE] OFF ON 0 1 :INPut[1]:IQ:BALanced[:STATE]?
------------------------	--

Notes:	For R&S FSQ-B71 compatibility, with no independent settings for the I and Q channels. Therefore, it is tied only to the I channel and does not provide an equivalent for the Q channel. For proper operation of the backwards compatibility command Q Same as I should be set to On.
Preset:	OFF
Initial S/W Revision:	Prior to A.02.00

I Input Z

Selects the input impedance for the I channel. The impedance applies to both the I and I-bar ports.

The input impedance controls the hardware signal path impedance match. It is not used for converting voltage to power. The voltage to power conversion always uses the Reference Z parameter. The Reference Z parameter applies to both I and Q channels.

Key Path:	Input/Output, I/Q, I Setup
Remote Command:	:INPut [1] : IQ [: I] : IMPedance LOW HIGH :INPut [1] : IQ [: I] : IMPedance?
Example:	Set the I channel input impedance to 1 MΩ INP:IQ:IMP HIGH
Notes:	LOW = 50 Ω, HIGH = 1 MΩ When IQ Path is I+jQ, the I Input Z setting must be the same as the Q Input Z setting. If the settings of the two inputs do not match, an error condition message is generated, 159;Settings Alert;I/Q mismatch:Input Z.
Couplings:	Input impedance is a built-in characteristic of a probe. Therefore, whenever a probe is sensed, this key is disabled and the value is set to match the probe. When no probe is sensed on Q and Q Same as I is On, the value set for I will also be copied to Q.
Preset:	LOW
State Saved:	Yes This is unaffected by a Preset but is set to the default value on a "Restore Input/Output Defaults" or "Restore System Defaults->All"
Range:	50 Ω 1 MΩ
Initial S/W Revision:	Prior to A.02.00

I Skew

Sets the skew factor for the I channel. The skew will shift the channel's data in time. Use this to compensate for differences in the electrical lengths of the input paths due to cabling.

Key Path:	Input/Output, I/Q, I Setup
-----------	-----------------------------------

Common Measurement Functions 1

Remote Command:	<code>[:SENSe]:CORRection:IQ[:I]:SKEW <seconds></code> <code>[:SENSe]:CORRection:IQ[:I]:SKEW?</code>
Example:	Delay the data for the I channel by 10 ns. <code>CORR:IQ:SKEW 10 ns</code>
Preset:	0
State Saved:	Yes This is unaffected by Preset but is set to the default value on a "Restore Input/Output Defaults" or "Restore System Defaults->All"
Range:	0 s to 100 ns
Initial S/W Revision:	Prior to A.02.00

I Probe

Access the probe setup parameters for the I channel. See [“I/Q Probe Setup” on page 1462](#).

Key Path:	Input/Output, I/Q, I Setup
State Saved:	No
Readback Text:	[<I port probe id>] This is reporting the type of probe sensed on the I port. There is no parameter for overriding what is sensed.
Initial S/W Revision:	Prior to A.02.00

Combined Differential/Input Z (Remote Command Only)

This is Remote Command only (no front panel) and is for backwards compatibility only. It combines the Differential Input and Input Z selections into a single SCPI command.

Remote Command:	<code>:INPut:IMPedance:IQ U50 B50 U1M B1M</code> <code>:INPut:IMPedance:IQ?</code>
Example:	<code>:INPut:IMPedance:IQ U50</code> This is equivalent to the following two SCPI commands: <code>:INP:IQ:DIFF OFF</code> <code>:INP:IQ:IMP 50</code>

Notes:	<p>Provided for E4406A code compatibility.</p> <p>The enum values translate as follows:</p> <p>U50: Differential Input = Off, Input Z = 50Ω</p> <p>B50: Differential Input = On, Input Z = 50Ω</p> <p>U1M: Differential Input = Off, Input Z = 1 MΩ</p> <p>B1M: Differential Input = On, Input Z = 1 MΩ</p> <p>This command is for backwards compatibility. It combines the Input Z (50Ω or 1 MΩ) parameter with the Differential Input (Off = "Unbalanced", On = "Balanced") parameter into a single enumeration.</p> <p>This backwards compatibility SCPI command was for an instrument without independent settings for the I and Q channels. Therefore, it is tied only to the I channel and does not provide an equivalent for the Q channel. For proper operation of the backwards compatibility command Q Same as I should be set to On.</p> <p>Also, note the subtle difference between this SCPI command and the backwards compatibility command for Input Z. The Input Z SCPI has "IQ" before "IMP" while this command has that order reversed.</p>
Couplings:	This command does not have an independent parameter, but instead is tied to the Differential Input and Input Z parameters. The coupling for those parameters apply to this command too.
Preset:	U50
Initial S/W Revision:	Prior to A.02.00

Q Setup

Access the channel setup parameters for the Q channel.

Key Path:	Input/Output, I/Q
Readback Text:	When Q Same as I is On the readback is "Q Same as I".
Initial S/W Revision:	Prior to A.02.00

Q Same as I

Many, but not all, usages require the I and Q channels have an identical setup. To simplify channel setup, the Q Same as I will cause the Q channel parameters to be mirrored from the I channel. That way you only need to set up one channel (the I channel). The I channel values are copied to the Q channel, so at the time Q Same as I is turned off the I and Q channel setups will be identical. This does not apply to Probe settings or to parameters that determined by the probe.

Key Path:	Input/Output, I/Q, Q Setup
Remote Command:	:INPut:IQ:MIRRored OFF ON 0 1 :INPut:IQ:MIRRored?

Common Measurement Functions 1

Example:	Turn off the mirroring of parameters from I to Q. INP:IQ:MIRR OFF
Couplings:	Only displayed for the Q channel. When Yes, the I channel values for some parameters are mirrored (copied) to the Q channel. However, when a parameter is determined by the type of probe and a probe is sensed, the probe setting is always used and the I channel setting is ignored. The following parameters are mirrored: Differential Input (when not determined by probe) Input Z (when not determined by probe)
Preset:	This is unaffected by a Preset but is set to the default value (Q Same as I set to "On") on a "Restore Input/Output Defaults" or "Restore System Defaults->All"
State Saved:	Saved in instrument state.
Range:	On Off
Readback Text:	"Q Same as I" when On, otherwise none.
Initial S/W Revision:	Prior to A.02.00

Q Differential Input

Selects differential input on or off for the Q channel. For differential input (also called balanced input), the analyzer uses both the Q and Q-bar ports. When differential input is off (also called single-ended or unbalanced input), the analyzer uses only the Q port.

Key Path:	Input/Output, I/Q, Q Setup
Remote Command:	:INPut:IQ:Q:DIFFerential OFF ON 0 1 :INPut:IQ:Q:DIFFerential?
Example:	Put the Q channel in Differential Input mode INP:IQ:Q:DIFF ON
Notes:	When Differential Input = On, the analyzer will check for attenuation mismatches between the Q and Q-bar ports. If the difference in attenuation values exceeds 0.5 dB a Settings Alert error condition, error 159 will be set. When Q Differential Input = On, and IQ Path is I+jQ, the I Differential input must also be On. Similarly, when Q Differential Input = Off, and IQ Path is I-jQ, the I Differential input must also be Off. If the states of the two inputs do not match, an error condition message is generated, 159;Settings Alert;I/Q mismatch:Differential.

Couplings:	Some active probes include built-in differential capability. When one of these probes is sensed, this key is disabled. Since the differential capability is handled in the probe, the Analyzer will use only the main port and the key will show that the Analyzer's Differential Input mode is Off (indicating that the complementary port not in use). When a differential probe is not sensed and Q Same as I is On, the value set for I will be copied to Q. This key is disabled when Q Same as I is On.
Preset:	Off
State Saved:	On This is unaffected by a Preset but is set to the default value on a "Restore Input/Output Defaults" or "Restore System Defaults->All"
Range:	Off On
Initial S/W Revision:	Prior to A.02.00

Q Input Z

Selects the input impedance for the Q channel. The impedance applies to both the Q and Q-bar ports.

The input impedance controls the hardware signal path impedance match. It is not used for converting voltage to power. The voltage to power conversion always uses the Reference Z parameter. The Reference Z parameter applies to both I and Q channels.

Key Path:	Input/Output, I/Q, Q Setup
Remote Command:	: INPut [1] : IQ : Q : IMPedance LOW HIGH : INPut [1] : IQ : Q : IMPedance?
Example:	Set the Q channel input impedance to 1 MΩ INP:IQ:Q:IMP HIGH
Notes:	LOW = 50 Ω, HIGH = 1 MΩ When IQ Path is I+jQ, the I Input Z setting must be the same as the Q Input Z setting. If the settings of the two inputs do not match, an error condition message is generated, 159;Settings Alert;I/Q mismatch:Input Z.
Couplings:	Input impedance is a built-in characteristic of a probe. Therefore, whenever a probe is sensed, this key is disabled and the value is set to match the probe. When no probe is sensed and Q Same as I is On, the value set for I will also be copied to Q. This key is disabled when Q Same as I is On.
Preset:	LOW
State Saved:	On This is unaffected by Preset but is set to the default value on a "Restore Input/Output Defaults" or "Restore System Defaults->All"
Range:	50 Ω 1 MΩ
Initial S/W Revision:	Prior to A.02.00

Common Measurement Functions 1

Q Skew

Sets the skew factor for the Q channel. The skew will shift the channel's data in time. Use this to compensate for differences in the electrical lengths of the input paths due to cabling and probes.

Key Path:	Input/Output, I/Q, Q Setup
Remote Command:	[:SENSe]:CORRection:IQ:Q:SKEW <seconds> [:SENSe]:CORRection:IQ:Q:SKEW?
Example:	Delay the data for the Q channel by 10 ns. CORR:IQ:Q:SKEW 10 ns
Preset:	0
State Saved:	Yes This is unaffected by a Preset but is set to the default value on a "Restore Input/Output Defaults" or "Restore System Defaults->All"
Range:	0 s to 100 ns
Initial S/W Revision:	Prior to A.02.00

Q Probe

Accesses the probe setup parameters for the Q channel. See "[I/Q Probe Setup](#)" on page 1462.

Key Path:	Input/Output, I/Q, Q Setup
State Saved:	No
Readback Text:	[<Q port probe id>] This is reporting the type of probe sensed on the Q port. There is no parameter for overriding what is sensed.
Initial S/W Revision:	Prior to A.02.00

I/Q Probe Setup

The set of I/Q probe setup parameters will change based on the type of probe that is sensed. All probe types have the Attenuation parameter, and all probe types can be calibrated. The remaining parameters are only available for some probe types and will not be shown when not available. The probe type is determined by and reported for only for the I and Q ports, never the I-bar or Q-bar ports. The menu title will be "<ch>: <probe id>", where "<ch>" is either "I" or "Q" and "<probe id>" is the type of probe. For example, for the I Probe setup with an Agilent 1130A probe connected to the I port, the title will be "I: 1130A".

Probe calibration data is stored for each probe type for each channel. When no probe is sensed, the probe type "Unknown" is used, and this is also treated like a probe type with its own calibration data. When a probe is changed, the calibration data for that probe type for that port is restored. An advisory message will be displayed showing the new probe type and the calibration status. The calibration data is stored permanently (survives a power cycle) and is not affected by a Preset or any of the Restore commands. When the probe has EEPROM identification (most newer Agilent probes have this), the calibration data

is stored by probe serial number and port, so if you have two probes of the same type, the correct calibration data will be used for each. For probes that do not have EEPROM identification, the calibration data is stored by probe type and port and the instrument cannot distinguish between different probes of the same type. In all cases (with or without EEPROM identification), the calibration data is port specific, so it will not follow a specific probe from port to port if the probe is moved.

The "Unknown" probe type is used whenever no probe is sensed. When no calibration data exists for "Unknown" the latest cable calibration data is used (see Section [“I/Q Guided Calibration” on page 1508](#)).

Attenuation

The attenuation is part of the calibration data stored with the probe type and is initially the value that was returned by the last calibration. You can modify this value and any changes will be stored with the calibration data and will survive power cycles and presets. When a probe calibration is performed the attenuation value will be overwritten by the calibration.

Key Path:	Input/Output, I/Q, I Setup Q Setup, I Probe Q Probe
Remote Command:	[:SENSE]:CORRection:IQ:I Q:ATTenuation:RATio <real> [:SENSE]:CORRection:IQ:I Q:ATTenuation:RATio?
Example:	Set the attenuation for the current I probe to 100.00:1. CORR:IQ:I:ATT:RAT 100
Notes:	Each probe type has its own attenuation setting. As probes are changed the attenuation value will reflect the new probe's setting. Changing the attenuation affects only the current probe type's setting and leaves all others unchanged. When the IQ Path is I+jQ, the Q probe attenuation setting must match the I Probe attenuation setting within 1 dB. If this is not the case, an error condition message is generated, 159;Settings Alert;I/Q mismatch:Attenuation.
Preset:	Each probe type has its own default. The default for the "Unknown" probe type is 1:1.
State Saved:	Saved with probe calibration data. It survives a power cycle and is not affected by a Preset or Restore.
Range:	0.001 to 10000
Initial S/W Revision:	Prior to A.02.00

Remote Command:	[:SENSE]:CORRection:IQ:I Q:ATTenuation <rel_ampl> [:SENSE]:CORRection:IQ:I Q:ATTenuation?
Example:	Set the attenuation for the current I probe type to 100.00:1. CORR:IQ:I:ATT 20 dB
Range:	-60 dB to +80 dB
Initial S/W Revision:	Prior to A.02.00

Common Measurement Functions 1

Offset

Some active probes have DC offset capability. When one of these probes is connected this control will be visible. The signal is adjusted for the DC offset before entering the analyzer's port. This allows for removal of a DC offset before hitting the analyzer's input port voltage limits. For example, a signal that varies 1 V peak-to-peak with a DC offset equal to the analyzer's max input voltage would exceed the input limits of the analyzer for half its cycle. Removing the DC offset allows the analyzer to correctly process the entire signal.

Key Path:	Input/Output, I/Q, I Setup Q Setup, I Probe Q Probe
Remote Command:	:INPut:OFFSet:I Q <voltage> :INPut:OFFSet:I Q?
Example:	Remove a DC offset of -0.5 V from the I channel input. INP:OFFS:I -0.5
Notes:	Only some probe types support Offset. For those that do, each probe type has its own Offset setting. As probes are changed the Offset value will reflect the new probe's setting. Changing the Offset affects only the current probe type's setting and leaves all others unchanged.
Preset:	0 V
State Saved:	Saved with probe calibration data. It survives power cycle and is not affected by Preset or Restore.
Range:	-18 V to +18 V
Initial S/W Revision:	Prior to A.02.00

Coupling

Some probe types allow coupling to reject low frequencies. This will filter out the DC component of a signal that is composed of a DC bias plus some AC signal. This control is visible only for probe types that have this capability.

Key Path:	Input/Output, I/Q, I Setup Q Setup, I Probe Q Probe
Remote Command:	:INPut:COUPling:I Q DC LFR1 LFR2 :INPut:COUPling:I Q?
Example:	Set the probe to low frequency rejection below 1.7 Hz. INP:COUP:I LFR1
Notes:	Only some probe types support Coupling. For those that do, each probe type has its own Coupling setting. As probes are changed the Coupling value will reflect the new probe's setting. Changing the Coupling affects only the current probe type's setting and leaves all others unchanged.
Preset:	DC
State Saved:	Saved with probe calibration data. It survives a power cycle and is not affected by a Preset or Restore.
Range:	DC AC 1.7 Hz LFR1 AC 0.14 Hz LFR2

Readback Text:	DC LFR1 LFR2
Initial S/W Revision:	Prior to A.02.00

DC

Turns off low frequency rejection, allowing signals down to DC.

Key Path:	Input/Output, I/Q, I Setup Q Setup, I Probe Q Probe, Coupling
Example:	Turn off low frequency rejection on the I channel INP:COUP:I DC
Initial S/W Revision:	Prior to A.02.00

LFR1

Turns on low frequency rejection, rejecting signal component lower than 1.7 Hz.

Key Path:	Input/Output, I/Q, I Setup Q Setup, I Probe Q Probe, Coupling
Example:	Turn on low frequency rejection on the I channel for frequencies lower than 1.7 Hz INP:COUP:I LFR1
Initial S/W Revision:	Prior to A.02.00

LFR2

Turns on low frequency rejection, rejecting signal component lower than 0.14 Hz.

Key Path:	Input/Output, I/Q, I Setup Q Setup, I Probe Q Probe, Coupling
Example:	Turn on low frequency rejection on the I channel for frequencies lower than 0.14 Hz INP:COUP:I LFR2
Initial S/W Revision:	Prior to A.02.00

Calibrate

Invokes the guided probe calibration. The guided probe calibration is context sensitive and depends on the channel (I or Q) and the Differential Input state. The calibration is only performed on the selected channel. When Differential Input is on, both the probe attached to the main port and the probe attached to the complementary port are calibrated. When Differential Input is off, only the probe attached to the main port is calibrated. See [“I/Q Guided Calibration” on page 1508](#).

Key Path:	Input/Output, I/Q, I Setup Q Setup, I Probe Q Probe, Coupling
-----------	--

Common Measurement Functions 1

Readback Text:	The last calibration date, or if no calibration exists, "(empty)". Last: <cal date> <cal time> Example: Last: 8/22/2007 1:02:49 PM
Initial S/W Revision:	Prior to A.02.00

Clear Calibration

Clears the calibration data for the current port and probe. It does not clear the data for other probe types or other ports. If the sensed probe has EEPROM identification, only the data for that specific probe is cleared. After this command has completed, the probe calibration state will be the same as if no probe calibration had ever been performed for the specified channel and probe. The probe attenuation will be the default value for that probe type and the Cable Calibration frequency response corrections will be used. This command is dependent on the Differential Input state. When Differential Input is on, both the data for the probe attached to the main port and the data for the probe attached to the complementary port are cleared. When Differential Input is off, only data for the probe attached to the main port is cleared.

Key Path:	Input/Output, I/Q, I Setup Q Setup, I Probe Q Probe
Remote Command:	:CALibration:IQ:PROBe:I Q:CLEar
Example:	Clear the calibration data for the I channel and the current probe (with EEPROM identification) or probe type (without EEPROM identification). :CAL:IQ:PROBe:I:CLE
Initial S/W Revision:	Prior to A.02.00

Reference Z

Sets the value of the impedance to be used in converting voltage to power for the I and Q channels. This does not change the hardware's path impedance (see ["I Input Z" on page 1457](#)).

Key Path:	Input/Output, I/Q
Remote Command:	:INPut:IMPedance:REFerence <integer> :INPut:IMPedance:REFerence?
Example:	Set the I/Q reference impedance to 50 Ω INP:IMP:REF 50
Preset:	50 Ω
State Saved:	Yes This is unaffected by a Preset but is set to the default value on a "Restore Input/Output Defaults" or "Restore System Defaults->All"
Range:	1 Ω to 1 M Ω

Initial S/W Revision:	Prior to A.02.00
-----------------------	------------------

I/Q Cable Calibrate...

Invokes the guided cable calibration. The guided cable calibration steps the user through a calibration of all ports (I, I-bar, Q, and Q-bar) using just a cable (no probe attached). See “I/Q Cable Calibrate...” on page 1509 for more information.

Key Path:	Input/Output, I/Q
Initial S/W Revision:	Prior to A.02.00

RF Calibrator

Lets you choose a calibrator signal to look at or turns the calibrator "off".

Key Path:	Input/Output
Remote Command:	[:SENSE] :FEED:AREFERENCE REF50 REF4800 OFF [:SENSE] :FEED:AREFERENCE?
Example:	FEED:AREF REF50 selects the 50 MHz amplitude reference as the signal input. FEED:AREF REF4800 selects the 4.8 GHz amplitude reference as the signal input FEED:AREF OFF turns the calibrator "off" (switches back to the selected input – RF or I/Q)
Dependencies:	Selecting an input (RF or I/Q) turns the Calibrator OFF. This is true whether the input is selected by the keys or with the [:SENSE]:FEED command. The 4.8 GHz internal reference is only available in some models and frequency range options. If the 4.8 GHz reference is not present, the 4.8 GHz softkey will be blanked, and if the REF4800 parameter is sent, the analyzer will generate an error.
Couplings:	When one of the calibrator signals is selected, the analyzer routes that signal (an internal amplitude reference) to the analyzer, and changes the main input selection to RF so the calibrator signal can be seen. When you turn the calibrator off it does not switch back to the previously selected input.
Preset:	OFF
State Saved:	Saved in instrument state
Readback:	Off, 50 MHz, 4.8 GHz
Initial S/W Revision:	Prior to A.02.00

Remote Command:	:CALibration:SOURce:STATE OFF ON 0 1 :CALibration:SOURce:STATE?
------------------------	--

Common Measurement Functions 1

Notes:	<p>For ESA backwards compatibility.</p> <p>In the ESA the calibrator was a separate output which you connected to the input and switched on with this command.</p> <p>In the X-Series, the ON parameter is aliased to the [SENSe]:FEED:AREF REF50 command and the OFF parameter is aliased to [SENSe]:FEED:AREF OFF.</p> <p>When CALibration:SOURce:STATe? is received, 1 will be returned if any of the references is selected and 0 if the Calibrator is "Off"</p>
Preset:	OFF
Initial S/W Revision:	Prior to A.02.00

50 MHz

Selects the 50 MHz internal reference as the input signal.

Key Path:	Input/Output, RF Calibrator
Example:	:FEED:AREF REF50
Readback:	50 MHz
Initial S/W Revision:	Prior to A.02.00

4.8 GHz

Selects the 4.8 GHz internal reference as the input signal.

Key Path:	Input/Output, RF Calibrator
Example:	:FEED:AREF REF4800
Dependencies:	The 4.8 GHz internal reference is only available in some models and frequency range options. If the 4.8 GHz reference is not present, the 4.8 GHz softkey will be blanked, and if the REF4800 parameter is sent, the analyzer will generate an error.
Readback:	4.8 GHz
Initial S/W Revision:	Prior to A.02.00
Modified at S/W Revision:	A.03.00

Off

Switches the input back to the selected input (RF or I/Q)

Key Path:	Input/Output, RF Calibrator
Example:	:FEED:AREF OFF
Readback:	Off

Initial S/W Revision:	Prior to A.02.00
-----------------------	------------------

External Gain

Compensates for gain or loss in the measurement system outside the spectrum analyzer. The External Gain is subtracted from the amplitude readout (or the loss is added to the amplitude readout). So, the displayed signal level represents the signal level at the output of the device-under-test, which can be the input of an external device that provides gain or loss.

Entering an External Gain value does not affect the Reference Level, therefore the trace position on screen changes, as do all of values represented by the trace data. Thus, the values of exported trace data, queried trace data, marker amplitudes, trace data used in calculations such as N dB points, trace math, peak threshold, etc., are all affected by External Gain. Changing the External Gain, even on a trace which is not updating, will immediately change all of the above, without new data needing to be taken.

NOTE	Changing the External Gain causes the analyzer to immediately stop the current sweep and prepare to begin a new sweep. The data will not change until the trace data updates because the offset is applied to the data as it is taken. If a trace is exported with a nonzero External Gain, the exported data will contain the trace data with the offset applied.
-------------	--

In the Spectrum Analyzer mode, a Preamp is the common external device providing gain or loss. In a measurement application mode like GSM or W-CDMA, the gain or loss could be from a BTS (Base Transceiver Station) or an MS (Mobile Station). So in the Spectrum Analyzer mode MS and BTS would be grayed out and the only choice would be Ext Preamp. Similarly in some of the digital communications applications, Ext Preamp will be grayed out and you would have a choice of MS or BTS.

Key Path:	Input/Output
Couplings:	The Ext Preamp, MS, and BS keys may be grayed out depending on which measurement is currently selected. If any of the grayed out keys are pressed, or the equivalent SCPI command is sent, an advisory message is generated.
Readback:	1-of-N selection [variable]
Initial S/W Revision:	Prior to A.02.00

Ext Preamp

This function is similar to the reference level offset function. Both affect the displayed signal level. Ref Lvl Offset is a mathematical offset only, no analyzer configuration is affected. Ext Preamp gain is used when determining the auto-coupled value of the Attenuator. The External Gain value and the Maximum Mixer Level settings are both part of the automatic setting equation for the RF attenuation setting. (10 dB of Attenuation is added for every 10 dB of External Gain.)

Note that the Ref Lvl Offset and Maximum Mixer Level are described in the Amplitude section. They are reset by the instrument Preset. The External Preamp Gain is reset by the "Restore Input/Output Defaults" or "Restore System Defaults->All functions.. The External Gain is subtracted from the amplitude readout so that the displayed signal level represents the signal level at the output of the

Common Measurement Functions 1

device-under-test, which is the input of the external device that is providing gain or loss.

Key Path:	Input/Output, External Gain
Remote Command:	[:SENSe]:CORRection:SA[:RF]:GAIN <rel_amp1> [:SENSe]:CORRection:SA[:RF]:GAIN?
Example:	CORR:SA:GAIN 10 sets the Ext Gain value to 10 dB CORR:SA:GAIN -10 sets the Ext Gain value to -10 dB (that is, an attenuation of 10 dB)
Notes:	Does not auto return.
Dependencies:	The reference level limits are determined in part by the External Gain/Atten, Max Mixer Level, and RF Atten. This key is grayed out in Modes that do not support External Gain
Preset:	This is unaffected by Preset but is set to 0 dB on a "Restore Input/Output Defaults" or "Restore System Defaults->All"
State Saved:	Saved in instrument state
Min:	-120 dB
Max:	120 dB
Readback:	Preamp Gain, <Ext Gain value> dB
Backwards Compatibility SCPI:	[:SENSe]:CORRection:OFFSet[:MAGNitude] The legacy "Ext Preamp Gain" key is now called "Ext Gain" and the sub-menu has choices of Ext Preamp MS BTS for backwards compatibility.
Initial S/W Revision:	Prior to A.02.00

MS

Sets an external gain/attenuation value for MS (Mobile Station) tests.

Key Path:	Input/Output, External Gain
Remote Command:	[:SENSe]:CORRection:MS[:RF]:GAIN <rel_amp1> [:SENSe]:CORRection:MS[:RF]:GAIN?
Example:	CORR:MS:GAIN 10 sets the Ext Gain value to 10 dB CORR:MS:GAIN -10 sets the Ext Gain value to -10 dB (that is, a loss of 10 dB.)
Notes:	Does not auto return.

Dependencies:	The reference level limits are determined in part by the External Gain, Max Mixer Level, RF Atten This key is grayed out in modes that do not support MS.
Preset:	This is unaffected by a Preset but is set to 0 dB on a "Restore Input/Output Defaults" or "Restore System Defaults->All"
State Saved:	Saved in instrument state.
Min:	-100 dB
Max:	100 dB
Readback:	MS, <Ext Gain value> dB
Initial S/W Revision:	Prior to A.02.00

Remote Command:	[:SENSE] :CORRection:MS[:RF] :LOSS <rel_ampl> [:SENSE] :CORRection:MS[:RF] :LOSS?
Example:	CORR:MS:LOSS 10 sets the Ext Gain value to -10 dB, and subsequently querying :LOSS will give 10 dB CORR:MS:LOSS -10 sets the Ext Gain value to 10 dB, and subsequently querying :LOSS will give -10 dB
Notes:	A positive value of <rel_ampl> in the above command means a loss and a negative value indicates a gain. Anytime :LOSS is set it sets :GAIN to the negative value of the parameter sent. Anytime :LOSS is queried it gives the negative of :GAIN
Preset:	This is unaffected by a Preset but is set to 0 dB on a "Restore Input/Output Defaults" or "Restore System Defaults->All"
Min:	100 dB
Max:	-100 dB
Initial S/W Revision:	Prior to A.02.00

BTS

Sets an external attenuation value for BTS (Base Transceiver Station) tests.

Key Path:	Input/Output, External Gain
Remote Command:	[:SENSE] :CORRection:BTS[:RF] :GAIN <rel_ampl> [:SENSE] :CORRection:BTS[:RF] :GAIN?

Common Measurement Functions 1

Example:	CORR:BTS:GAIN 10 sets the Ext Gain value to 10 dB CORR:BTS:GAIN -10 sets the Ext Gain value to -10 dB (that is, a loss of 10 dB.)
Notes:	Does not auto return.
Dependencies:	The reference level limits are determined in part by the External Gain, Max Mixer Level, RF Atten This key is grayed out in modes that do not support BTS.
Preset:	This is unaffected by a Preset but is set to 0 dB on a "Restore Input/Output Defaults" or "Restore System Defaults->All"
State Saved:	Saved in instrument state.
Min:	-100 dB
Max:	100 dB
Readback:	BTS, <Ext Gain value> dB
Initial S/W Revision:	Prior to A.02.00

Remote Command:	[:SENSE]:CORRection:BTS[:RF]:LOSS <rel_ampl> [:SENSE]:CORRection:BTS[:RF]:LOSS?
Example:	CORR:BTS:LOSS 10 sets the Ext Gain value to -10 dB, and subsequently querying :LOSS will give 10 dB CORR:BTS:LOSS -10 sets the Ext Gain value to 10 dB, and subsequently querying :LOSS will give -10 dB
Notes:	A positive value of <rel_ampl> in the above command means a loss and a negative value indicates a gain. Anytime :LOSS is set it sets :GAIN to the negative value of the parameter sent. Anytime :LOSS is queried it gives the negative of :GAIN
Preset:	This is unaffected by a Preset but is set to 0 dB on a "Restore Input/Output Defaults" or "Restore System Defaults->All"
Min:	100 dB
Max:	-100 dB
Initial S/W Revision:	Prior to A.02.00

I Ext Gain

This function affects only the I channel input, except when the Input Path is I+jQ. In I+jQ this setting is applied to both I and Q channel inputs. It is not available unless the Baseband I/Q option (BBA) is

installed.

Key Path:	Input/Output, External Gain
Remote Command:	[:SENSE]:CORRection:IQ:I:GAIN <rel_ampl> [:SENSE]:CORRection:IQ:I:GAIN?
Example:	Set the I Ext Gain to 10 dB CORR:IQ:I:GAIN 10 Set the I Ext Gain to -10 dB (that is, a loss of 10 dB.) CORR:IQ:I:GAIN -10
Notes:	Not available unless option BBA is installed
Preset:	0 dB This is unaffected by a Preset but is set to 0 dB on a "Restore Input/Output Defaults" or "Restore System Defaults->All"
State Saved:	Saved in instrument state.
Min:	-100 dB
Max:	100 dB
Readback Text:	I Gain, <I Ext Gain> dB
Initial S/W Revision:	Prior to A.02.00

Q Ext Gain

This function affects only the Q channel input and only when the Input Path is not I+jQ. It is not available unless the Baseband I/Q option (BBA) is installed.

Key Path:	Input/Output, External Gain
Remote Command:	[:SENSE]:CORRection:IQ:Q:GAIN <rel_ampl> [:SENSE]:CORRection:IQ:Q:GAIN?
Example:	Set the Q Ext Gain to 10 dB CORR:IQ:Q:GAIN 10 Set the Q Ext Gain to -10 dB (that is, a loss of 10 dB.) CORR:IQ:Q:GAIN -10
Notes:	Not available unless option BBA is installed.
Preset:	0 dB This is unaffected by a Preset but is set to 0 dB on a "Restore Input/Output Defaults" or "Restore System Defaults->All"
State Saved:	Saved in instrument state.
Min:	-100 dB

Common Measurement Functions 1

Max:	100 dB
Readback Text:	Q Gain, <I Ext Gain> dB
Initial S/W Revision:	Prior to A.02.00

Restore Input/Output Defaults

This selection causes the group of settings and data associated with the **Input/Output** key to be a reset to their default values. In addition, when a Source is installed, licensed and selected, Restore Input/Output defaults will initiate a Source Preset.

This level of Restore System Defaults does not affect any other system settings or mode settings and does not cause a mode switch. All the features described in this section are reset using this key, including Input Corrections and Data (described in the Corrections section).

Key Path:	Input/Output
Example:	:SYST:DEF INP presets all the Input/Output variables to their factory default values.
Notes:	Refer to the Utility Functions for information about Restore System Defaults and the complete description of the :SYSTem:DEFault INPut: command.
Initial S/W Revision:	Prior to A.02.00

Data Source

Gives you the choice of either using a hardware input signal as the input or raw data stored in a data storage buffer from an earlier acquisition. You can also share raw data across certain measurements that support this feature. The measurements must be capable of storing raw data. There are three choices under this menu. You can select "Inputs" which is the same as selecting one of the inputs from the input port, for example RF, AREF, I/Q, or IFALign. Selecting "Capture Buffer" allows you to use data that has been stored earlier in the same measurement or from a previous measurement using the "Current Meas -> Capture Buffer" feature. Selecting "Recorded Data" allows you to playback long data capture records stored in the record buffer.

When you make a recording (see [“Record Data Now” on page 1476](#)) or when you recall a recording (see the Recall section) the data source is automatically set to Recorded Data. You can toggle the data source between Inputs and the current Recording (if there is one). That is, the recording remains in memory until it is replaced by a new recording, or the application is closed.

Key Path:	Input/Output
Remote Command:	[:SENSe] :FEED:DATA INPut STORed RECorded [:SENSe] :FEED:DATA?
Example:	FEED:DATA REC FEED:DATA?

Notes:	INPutS = Inputs STORed = Capture Buffer RECOred = Record Data Buffer
Dependencies:	Not all inputs are available in all modes. Unavailable keys are grayed out.
Preset:	This is unaffected by Preset but is set to INPut on a "Restore Input/Output Defaults" or "Restore System Defaults->All"
State Saved:	Saved in instrument state
Readback:	Variable
Backwards Compatibility SCPI:	[:SENSe]:FEED:SOURce INPut STORed [:SENSe]:FEED:SOURce?
Initial S/W Revision:	Prior to A.02.00

Inputs

Sets the measurement to use the input selections (RF, AREF, I/Q)

Key Path:	Input/Output, Data Source
Example:	FEED:DATA INP causes the measurement to look at the input selection
Notes:	Does not auto return.
Readback:	Inputs
Initial S/W Revision:	Prior to A.02.00

Capture Buffer

Some WCDMA and demod measurements support this feature. This allows sharing of the raw data across certain measurements. If you want to make another measurement on the same signal, you would store that raw data using the "Current Meas -> Capture Buffer" key. Then the data is available for the next measurement to use. You must have raw data stored in the instrument memory before the Capture Buffer choice is available for use.

Key Path:	Input/Output, Data Source
Example:	FEED:DATA STOR causes stored measurement data to be used with a different measurement that supports this.
Notes:	Does not auto return. This key is grayed out when you switch to a measurement that does not support this feature.
Dependencies:	If you switch to a measurement that does not support this feature, then the instrument switches to use "Inputs" and grays out this key. If the grayed out key is pressed, it generates a message.
Readback:	Stored Data

Common Measurement Functions 1

Initial S/W Revision:	Prior to A.02.00
-----------------------	------------------

Recorded Data

Directs the instrument to get data from the record data buffer in the measurement, rather than from the RF Input Signal.

Key Path:	Input/Output, Data Source
Example:	FEED:DATA REC causes the measurement to extract data from the record data buffer.
Notes:	Does not auto return.
Dependencies:	Grayed out in the SA measurement.
Readback:	Recorded Data
Initial S/W Revision:	Prior to A.02.00

Current Meas -> Capture Buffer

Pressing this key stores the raw data of one measurement in the internal memory of the instrument where it can then be used by a different measurement by pressing "Stored Data". When raw data is stored, then the data source selection switch automatically changes to "Stored Data". Stored raw data cannot be directly accessed by a user. There is no save/recall function to save the raw data in an external media. However if you want to get the stored raw data, you must first perform a measurement using the stored raw data. Now you can access the used raw data, which is the same as stored raw data, using the FETCh or READ commands.

Key Path:	Input/Output, Data Source
Remote Command:	[:SENSE] :FEED:DATA:STORe
Example:	FEED:DATA:STOR stores recorded data
Notes:	This is command only, there is no query
Dependencies:	Grayed out in the SA measurement.
Backwards Compatibility SCPI:	[:SENSE]:FEED:SOURce:STORe
Initial S/W Revision:	Prior to A.02.00

Record Data Now

This causes the data source to change to Inputs (if it is not already set) and a recording is made with the current instrument setup. The length of the recording must be specified in advance.

This key changes to **Abort Recording** once the recording process has started. It changes back when the recording is complete.

The following dialogs show the progress of the recording:

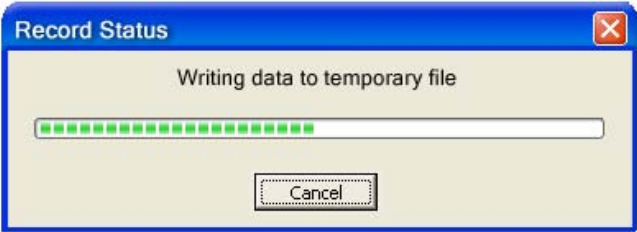
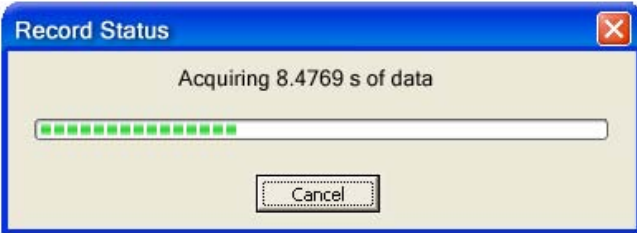

This key is also available in the Sweep/Control menu.

Key Path:	Input/Output, Data Source
Mode:	VSA
Remote Command:	[:SENSe] :RECOrding :INITiate [:IMMediate]
Example:	REC:INIT
Notes:	This is command only, there is no query. See the Recall functionality to access previously saved data.
Dependencies:	Grayed out in the SA measurement.
Couplings:	Changes Data source to Recorded Data.
Initial S/W Revision:	Prior to A.02.00

Key Path:	Input/Output, Data Source
Remote Command:	[:SENSe] :RECOrding :ABORt
Example:	REC:ABOR
Notes:	This is command only, there is no query. The command does nothing if it is sent when there is no recording in progress.
Initial S/W Revision:	Prior to A.02.00

Record Length

This specifies the length of the next recording. (You cannot use this to modify the length of the current recording.) The length defaults to seconds, but you can also specify it in points at the current sample rate, or in time records at the current time record length.

Key Path:	Input/Output, Data Source
-----------	----------------------------------

Common Measurement Functions 1

Mode:	VSA
Remote Command:	[:SENSe]:RECOrding:LENGth <real>,SECOnds RECOrds POINts [:SENSe]:RECOrding:LENGth:STATe MAX MANual [:SENSe]:RECOrding:LENGth:STATe?
Example:	REC:LENG 20,REC REC:LENG 4.1E-4,SEC REC:LENG:STAT MAX REC:LENG:STAT?
Notes:	There is no default unit. The unit must be specified. The length command does not have a query form. Length information is queried using the two commands following this table. If set to MAX, all of the available "recording memory" us used.
Preset:	50 Records, Manual
State Saved:	No
Min:	0
Max:	Depends on memory available.
Readback:	<value><Seconds Points Records>
Initial S/W Revision:	Prior to A.02.00

Mode:	VSA
Remote Command:	[:SENSe]:RECOrding:LENGth:VALue?
Example:	REC:LENG:VAL?
Notes:	Query Only Returns the first (numeric) parameter of the most recent [:SENSe]:RECOrding:LENGth command.
Preset:	50 Records
Initial S/W Revision:	Prior to A.02.00

Mode:	VSA
Remote Command:	[:SENSe]:RECOrding:LENGth:UNIT?
Example:	REC:LENG:UNIT?

Notes:	Query Only Returns the second parameter of the most recent [:SENSe]:RECORDing:LENGth command. Possible values are SEC REC POIN. If no second parameter was sent, then the return value is SEC.
Preset:	RECORDs
Initial S/W Revision:	Prior to A.02.00

Corrections

This key accesses the Amplitude Corrections menu.

Amplitude Corrections arrays can be entered, sent over SCPI, or loaded from a file. They allow you to correct the response of the analyzer for various use cases. The X-series supports four separate Corrections arrays, each of which can contain up to 2000 points. They can be turned on and off individually and any or all can be on at the same time.

Trace data is in absolute units and corrections data is in relative units, but we want to be able to display trace data at the same time as corrections data. Therefore we establish a reference line to be used while building or editing a Corrections table. The reference line is halfway up the display and represents 0 dB of correction. It is labeled “0 dB CORREC”. It is drawn in blue.

Corrections data is always in dB. Whatever dB value appears in the correction table represents the correction to be applied to that trace at that frequency. So if a table entry shows 30 dB that means we ADD 30 dB to each trace to correct it before displaying it.

In zero span, where the frequency is always the center frequency of the analyzer, we apply the (interpolated) correction for the center frequency to all points in the trace. In the event where there are two correction amplitudes at the center frequency, we apply the first one in the table.

Note that the corrections are applied as the data is taken; therefore, a trace in **View** (Update Off) will not be affected by changes made to the corrections table after the trace is put in **View**.

Key Path:	Input/Output, Corrections
Mode:	SA, DVB-T/H, DTMB, SEQAN, TDSCDMA
Dependencies:	This key will only appear if you have the proper option installed in your instrument. Amplitude correction may not be available in all modes; if a mode does not support amplitude correction, the Corrections key should be blanked while in that mode. If an application supports corrections but the current measurement does not, then the key should be grayed out in that measurement
Preset:	Corrections arrays are reset (deleted) by Restore Input/Output Defaults. They survive shutdown and restarting of the analyzer application, which means they will survive a power cycle.
Initial S/W Revision:	A.02.00

Common Measurement Functions 1

Select Correction

Specifies the selected correction. The term "selected correction" is used throughout this document to specify which correction will be affected by the functions.

Key Path:	Input/Output, Corrections
Mode:	SA
Notes:	The selected correction is remembered even when not in the correction menu.
Preset:	Set to Correction 1 by Restore Input/Output Defaults
Readback:	Correction 1 Correction 2 Correction 3 Correction 4 Correction 5 Correction 6
Initial S/W Revision:	A.02.00

Correction On/Off

Turning the Selected Correction on allows the values in it to be applied to the data. This also automatically turns on "Apply Corrections" (sets it to ON), otherwise the correction would not take effect.

A new sweep is initiated if an amplitude correction is switched on or off. Note that changing, sending or loading corrections data does NOT directly initiate a sweep, however in general these operations will turn corrections on, which DOES initiate a sweep.

Key Path:	Input/Output, Corrections
Remote Command:	[:SENSE]:CORREction:CSET[1] 2 3 4 5 6[:STATE] ON OFF 1 0 [:SENSE]:CORREction:CSET[1] 2 3 4 5 6[:STATE]?
Example:	SENS:CORR:CSET1 ON
Dependencies:	Turning this on automatically turns on "Apply Corrections" Only the first correction array (Correction 1) supports antenna units. When this array is turned on, and it contains an Antenna Unit other than "None", the Y Axis Unit of the analyzer is forced to that Antenna Unit. All other Y Axis Unit choices are grayed out. Note that this means that a correction file with an Antenna Unit can only be loaded into the Corrections 1 register. Consequently only for Correction 1 does the dropdown in the Recall dialog include.ant, and if an attempt is made to load a correction file into any other Correction register which DOES contain an antenna unit, a Mass Storage error is generated. This command will generate an "Option not available" error unless you have the proper option installed in your instrument.
Preset:	Not affected by a Preset. Set to OFF by Restore Input/Output Defaults
State Saved:	Saved in instrument state.

Backwards Compatibility Notes:	Unlike legacy analyzers, Preset does not turn Corrections off (Restore Input/Output Defaults does).
Initial S/W Revision:	A.02.00

Properties

Accesses a menu that lets you set the properties of the selected correction.

Key Path:	Input/Output, Corrections
Initial S/W Revision:	A.02.00

Select Correction

Specifies the selected correction. The term "selected correction" is used throughout this document to specify which correction will be affected by the functions.

Key Path:	Input/Output, Corrections, Properties
Notes:	The selected correction is remembered even when not in the correction menu.
Preset:	Set to Correction 1 by Restore Input/Output Defaults.
Readback:	Correction 1 Correction 2 Correction 3 Correction 4 Correction 5 Correction 6
Initial S/W Revision:	A.02.00

Antenna Unit

For devices (like antennae) which make measurements of field strength or flux density, the correction array should contain within its values the appropriate conversion factors such that, when the data on the analyzer is presented in dBµV, the display is calibrated in the appropriate units. The "Antenna Unit" used for the conversion is contained within the corrections array database. It may be specified by the user or loaded in from an external file or SCPI.

When an array with an Antenna Unit other than "None" is turned on, the Y Axis Unit of the analyzer is forced to that unit. When this array is turned on, and it contains an Antenna Unit other than "None", the Y Axis Unit of the analyzer is forced to that Antenna Unit., and all other Y Axis Unit choices are grayed out.

Antenna Unit does not appear in all Modes that support Corrections. Only the modes listed in the Mode row of the table below support Antenna Units.

Key Path:	Input/Output, Corrections, Properties
Mode:	SA
Remote Command:	[:SENSE]:CORRection:CSET[1] 2 3 4:ANTenna[:UNIT] GAUSS PTES1a UVM UAM NOConversion [:SENSE]:CORRection:CSET[1] 2 3 4:ANTenna[:UNIT]?
Example:	CORR:CSET:ANT GAUS

Common Measurement Functions 1

Dependencies:	Only the first correction array (Correction 1) supports antenna units. Note that this means that a correction file with an Antenna Unit can only be loaded into the Corrections 1 register. Consequently only for Correction 1 does the dropdown in the Recall dialog include.ant, and if an attempt is made to load a correction file into any other Correction register which DOES contain an antenna unit, a Mass Storage error is generated.
Preset:	Unaffected by Preset. Set to NOC by Restore Input/Output Defaults
State Saved:	Saved in State
Initial S/W Revision:	A.02.00

dB μ V/m

Sets the antenna unit to dB μ V/m. If this correction is turned on, and Apply Corrections is on, the Y Axis Unit will then be forced to dB μ V/m and all other Y Axis Unit selections will be grayed out.

Key Path:	Input/Output, Corrections, Properties, Antenna Unit
Example:	:CORR:CSET2:ANT UVM
Readback:	"dB μ V/m"
Initial S/W Revision:	A.02.00

dB μ A/m

Sets the antenna unit to dB μ A/m. If this correction is turned on, and Apply Corrections is on, the Y Axis Unit will then be forced to dB μ A/m and all other Y Axis Unit selections will be grayed out.

Key Path:	Input/Output, Corrections, Properties, Antenna Unit
Example:	:CORR:CSET2:ANT UVA
Readback:	" dB μ A/m"
Initial S/W Revision:	A.02.00

dBpT

Sets the antenna unit to dBpT. If this correction is turned on, and Apply Corrections is on, the Y Axis Unit will then be forced to dBpT and all other Y Axis Unit selections will be grayed out.

Key Path:	Input/Output, Corrections, Properties, Antenna Unit
Example:	:CORR:CSET3:ANT PTES
Readback:	"dBpT"
Initial S/W Revision:	A.02.00

DBG

Sets the antenna unit to DBG. If this correction is turned on, and Apply Corrections is on, the Y Axis Unit will then

be forced to dBG and all other Y Axis Unit selections will be grayed out.

Key Path:	Input/Output, Corrections, Properties, Antenna Unit
Example:	:CORR:CSET:ANT GAUS
Readback:	" dBG"
Initial S/W Revision:	A.02.00

None

Selects no antenna unit for this Correction set. Thus no Y Axis unit will be forced.

Key Path:	Input/Output, Corrections, Properties, Antenna Unit
Example:	:CORR:CSET4:ANT NOC
Readback:	"None"
Initial S/W Revision:	A.02.00

Frequency Interpolation

This setting controls how the correction values per-bucket are calculated. We interpolate between frequencies in either the logarithmic or linear scale.

This setting is handled and stored individually per correction set.

See [“Interpolation” on page 1483](#)

Key Path:	Input/Output, Corrections, Properties
Remote Command:	[:SENSE] :CORRection:CSET[1] 2 3 4 5 6 :X:SPACing LINear LOGarithmic [:SENSE] :CORRection:CSET[1] 2 3 4 5 6 :X:SPACing?
Example:	CORR:CSET:X:SPAC LIN
Preset:	Unaffected by a Preset. Set to Linear by Restore Input/Output Defaults.
State Saved:	Saved in instrument state.
Initial S/W Revision:	A.02.00

Interpolation

For each bucket processed by the application, all of the correction factors at the frequency of interest (center frequency of each bucket) are summed and added to the amplitude. All trace operations and post processing treat this post-summation value as the true signal to use.

To effect this correction, the goal, for any particular start and stop frequency, is to build a correction trace, whose number of points matches the current Sweep Points setting of the instrument, which will be used to apply corrections on a bucket by bucket basis to the data traces.

For amplitudes that lie between two user specified frequency points, we interpolate to determine the amplitude value. You may select either linear or logarithmic interpolation between the frequencies.

Common Measurement Functions 1

If we interpolate on a log scale, we assume that the line between the two points is a straight line on the log scale. For example, let's say the two points are (2,4) and (20,1). A straight line between them on a log scale looks like:

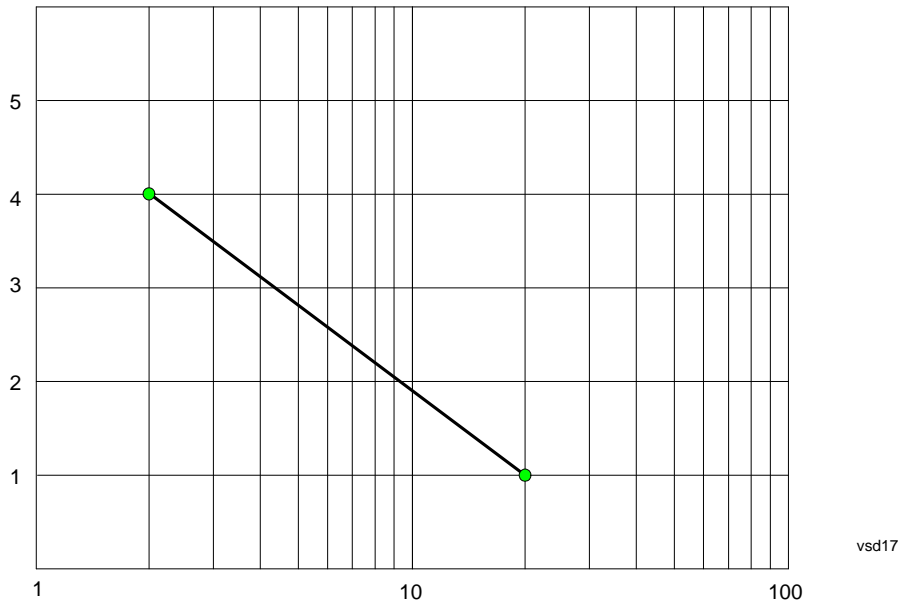

On a linear scale (like that of the spectrum analyzer), this translates to:

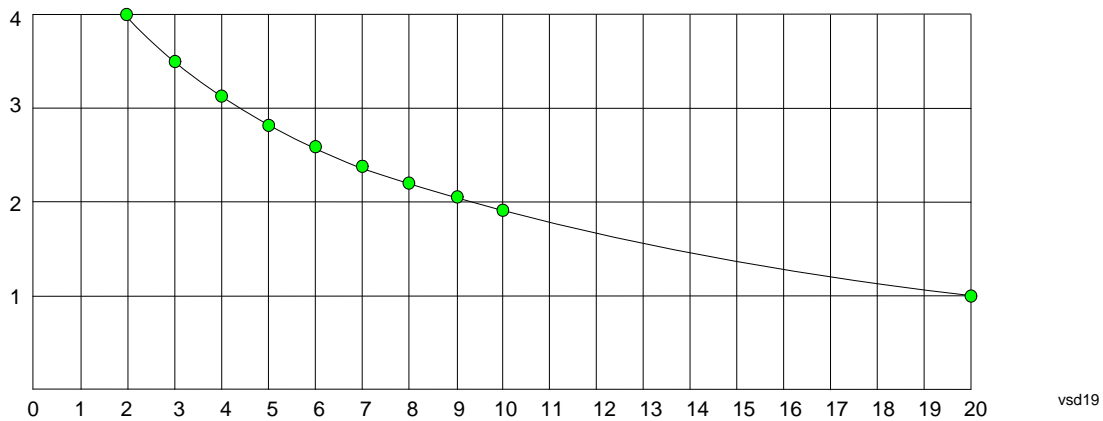

On the other hand, if we interpolate on a linear scale, we assume that the two points are connected by a straight line on the linear scale, as below:

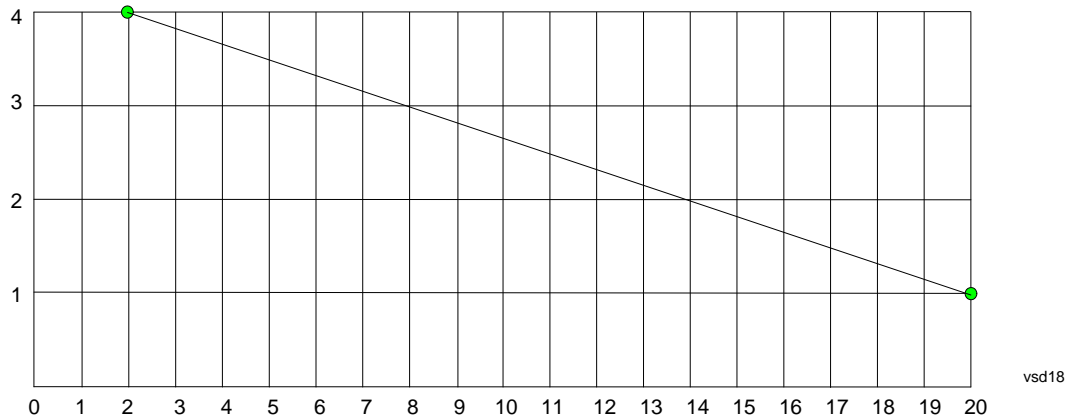

The correction to be used for each bucket is taken from the interpolated correction curve at the center of the bucket.

Description

Sets an ASCII description field which will be stored in an exported file. Can be displayed in the active function area by selecting as the active function, if desired to be in a screen dump.

Key Path:	Input/Output, Corrections, Properties
Remote Command:	[:SENSE] :CORRection:CSET[1] 2 3 4 5 6 :DESCRiption "text" [:SENSE] :CORRection:CSET[1] 2 3 4 5 6 :DESCRiption?
Example:	:CORR:CSET1:DESC "11941A Antenna correction"
Notes:	45 chars max; may not fit on display if max chars used
Preset:	Unaffected by a Preset. Set to empty by Restore Input/Output Defaults
State Saved:	Saved in instrument state.
Initial S/W Revision:	A.02.00

Comment

Sets an ASCII comment field which will be stored in an exported file. Can be displayed in the active function area by selecting as the active function, if desired to be in a screen dump.

Key Path:	Input/Output, Corrections, Properties
Remote Command:	[:SENSE] :CORRection:CSET[1] 2 3 4 5 6 :COMMent "text" [:SENSE] :CORRection:CSET[1] 2 3 4 5 6 :COMMent?
Example:	:CORR:CSET1:COMM "this is a comment"
Notes:	45 chars max; may not fit on display if max chars used
Preset:	Unaffected by Preset. Set to empty by Restore Input/Output Defaults
State Saved:	Saved in instrument state
Initial S/W Revision:	A.02.00

Common Measurement Functions 1

Edit

Invokes the integrated editing facility for this correction set.

When entering the menu, the editor window turns on, the selected correction is turned **On**, **Apply Corrections** is set to **On**, the amplitude scale is set to **Log**, and the Amplitude Correction (“Ampcor”) trace is displayed. The actual, interpolated correction trace is shown in green for the selected correction. Note that since the actual interpolated correction is shown, the correction trace may have some curvature to it. This trace represents only the correction currently being edited, rather than the total, accumulated amplitude correction for all amplitude corrections which are currently on, although the total, accumulated correction for all corrections which are turned on is still applied to the data traces.

Because corrections data is always in dB, but the Y-axis of the analyzer is in absolute units, it is necessary to establish a reference line for display of the Corrections data. The reference line is halfway up the display and represents 0 dB of correction. It is labeled “0 dB CORREC”. It is drawn in blue.

Corrections data is always in dB. Whatever dB value appears in the correction table represents the correction to be applied to that trace at that frequency. So if a table entry shows 30 dB that means we ADD 30 dB to each trace to correct it before displaying it. By definition all points are connected. If a gap is desired for corrections data, enter 0 dB.

Note that a well-designed Corrections array should start at 0 dB and end at 0 dB. This is because whatever the high end point is will be extended to the top frequency of the instrument, and whatever the low end point is will be extended down to 0 Hz. So for a Corrections array to have no effect outside its range, you should start and end the array at 0 dB.

NOTE The table editor will only operate properly if the analyzer is sweeping, because its updates are tied to the sweep system. Thus, you should not try to use the editor in single sweep, and it will be sluggish during compute-intensive operations like narrow-span FFT sweeps.

When exiting the edit menu (by using the **Return** key or by pressing an instrument front-panel key), the editor window turns off and the Ampcor trace is no longer displayed; however, **Apply Corrections** remains **On**, any correction that was on while in the editor remains on, and the amplitude scale returns to its previous setting.

Corrections arrays are not affected by a Preset, because they are in the Input/Output system. They also survive shutdown and restarting of the analyzer application, which means they will survive a power cycle.

Key Path:	Input/Output, Corrections
Initial S/W Revision:	A.02.00

Navigate

Lets you move through the table to edit the desired point.

Key Path:	Input/Output, Corrections, Edit
Notes:	There is no value readback on the key

Min:	1
Max:	2000
Initial S/W Revision:	A.02.00

Frequency

Lets you edit the frequency of the current row.

Key Path:	Input/Output, Corrections, Edit
Notes:	There is no value readback on the key.
Min:	0
Max:	1 THz
Initial S/W Revision:	A.02.00

Amplitude

Lets you edit the Amplitude of the current row.

Key Path:	Input/Output, Corrections, Edit
Notes:	There is no value readback on the key.
Min:	-1000 dB
Max:	1000 dB
Initial S/W Revision:	A.02.00

Insert Point Below

Inserts a point below the current point. The new point is a copy of the current point and becomes the current point. The new point is not yet entered into the underlying table, and the data in the row is displayed in light gray.

Key Path:	Input/Output, Corrections, Edit
Initial S/W Revision:	A.02.00

Delete Point

Deletes the currently-selected point, whether or not that point is being edited, and selects the Navigate functionality. The point following the currently-selected point (or the point preceding if there is none) will be selected.

Key Path:	Input/Output, Corrections, Edit
Initial S/W Revision:	A.02.00

Scale X Axis

Matches the X Axis to the selected Correction, as well as possible. Sets the Start and Stop Frequency to contain the

Common Measurement Functions 1

minimum and maximum Frequency of the selected Correction. The range between Start Frequency and Stop Frequency is 12.5% above the range between the minimum and maximum Frequency, so that span exceeds this range by one graticule division on either side. If in zero-span, or there is no data in the Ampcor table, or the frequency range represented by the table is zero, no action is taken. Standard clipping rules apply if the value in the table is outside the allowable range for the X axis.

Key Path:	Input/Output, Corrections, Edit
Dependencies:	If either the first or last point in the array is outside the frequency range of the current input, an error message is generated: “-221. Settings conflict; Start or Stop Freq out of range for current input settings”
Initial S/W Revision:	A.02.00

Delete Correction

Deletes the correction values for this set. When this key is pressed a prompt is placed on the screen that says “Please press Enter or OK key to delete correction. Press ESC or Cancel to close this dialog.” The deletion is only performed if you press OK or Enter.

Key Path:	Input/Output, Corrections
Remote Command:	[:SENSe]:CORRection:CSET[1] 2 3 4 5 6:DELeTe
Example:	CORR:CSET:DEL CORR:CSET1:DEL CORR:CSET4:DEL
Notes:	Pressing this key when no corrections are present is accepted without error.
Initial S/W Revision:	A.02.00

Apply Corrections

Applies amplitude corrections which are marked as ON to the measured data. If this is set to OFF, then no amplitude correction sets will be used, regardless of their individual on/off settings. If set to ON, the corrections that are marked as ON (see [“Correction On/Off” on page 1480](#)) are used.

Key Path:	Input/Output, Corrections
Remote Command:	[:SENSe]:CORRection:CSET:ALL[:STATe] ON OFF 1 0 [:SENSe]:CORRection:CSET:ALL[:STATe]?
Example:	SENS:CORR:CSET:ALL OFF This command makes sure that no amplitude corrections are applied, regardless of their individual on/off settings.
Preset:	Not affected by Preset. Set to OFF by Restore Input/Output Defaults
State Saved:	Saved in instrument state.
Initial S/W Revision:	A.02.00

Delete All Corrections

Erases all correction values for all 4 Amplitude Correction sets.

When this key is pressed a prompt is placed on the screen that says “Please press Enter or OK key to delete all corrections. Press ESC or Cancel to close this dialog.” The deletion is only performed if you press OK or Enter.

Key Path:	Input/Output, Corrections
Remote Command:	[:SENSE]:CORRection:CSET:ALL:DELeTe
Example:	CORR:CSET:ALL:DEL
Initial S/W Revision:	A.02.00

Remote Correction Data Set Commands

Set (Replace) Data (Remote Command Only)

The command takes an ASCII series of alternating frequency and amplitude points, each value separated by commas.

The values sent in the command will totally replace all existing correction points in the specified set.

An Ampcor array can contain 2000 points maximum.

Remote Command:	[:SENSE]:CORRection:CSET[1] 2 3 4 5 6:DATA <freq>, <ampl>, . . . [:SENSE]:CORRection:CSET[1] 2 3 4 5 6:DATA?
Example:	CORR:CSET1:DATA 10000000,-1.0,20000000,1.0 This defines two correction points at (10 MHz, -1.0 dB) and (20 MHz, 1.0 dB) for correction set 1.
Preset:	Empty after Restore Input/Output Defaults. Survives a shutdown or restart of analyzer application (including a power cycle).
State Saved:	Saved in instrument state.
Min:	Freq: 0 Hz Amptd: -1000 dBm
Max:	Freq: 1 THz Amptd: +1000 dBm
Initial S/W Revision:	A.02.00

Merge Correction Data (Remote Command Only)

The command takes an ASCII series of alternating frequency and amplitude points, each value separated by commas. The difference between this command and Set Data is that this merges new correction points into an existing set.

Any new point with the same frequency as an existing correction point will replace the existing point’s amplitude with that of the new point.

Common Measurement Functions 1

An Ampcor array can contain 2000 total points, maximum.

Remote Command:	[:SENSE]:CORRection:CSET[1] 2 3 4 5 6 :DATA:MERGe <freq>, <ampl>, ...
Example:	CORR:CSET1:DATA:MERGE 15000000,-5.0,25000000,5.0 This adds two correction points at (15 MHz, -5.0 dB) and (25 MHz, 5.0 dB) to whatever values already exist in correction set 1.
Preset:	Empty after Restore Input/Output Defaults. Survives shutdown/restart of analyzer application (including power cycle)
Min:	Freq: 0 Hz Amptd: -1000 dBm
Max:	Freq: 1 THz Amptd: +1000 dBm
Initial S/W Revision:	A.02.00

Freq Ref In

Specifies the frequency reference as being the internal reference, external reference or sensing the presence of an external reference.

When the frequency reference is set to internal, the internal 10 MHz reference is used even if an external reference is connected.

When the frequency reference is set to external, the instrument will use the external reference. However, if there is no external signal present, or it is not within the proper amplitude range, a condition error message is generated. When the external signal becomes valid, the error is cleared.

If Sense is selected, the instrument checks whether a signal is present at the external reference connector and will automatically switch to the external reference when a signal is detected. When no signal is present, it automatically switches to the internal reference. No message is generated as the reference switches between external and internal. The monitoring of the external reference occurs approximately on 1 millisecond intervals, and never occurs in the middle of a measurement acquisition, only at the end of the measurement (end of the request).

If for any reason the instrument's frequency reference is not able to obtain lock, Status bit 2 in the Questionable Frequency register will be true and a condition error message is generated. When lock is regained, Status bit 2 in the Questionable Frequency register will be cleared and the condition error will be cleared.

If an external frequency reference is being used, you must enter the frequency of the external reference if it is not exactly 10 MHz. The External Ref Freq key is provided for this purpose.

Key Path:	Input/Output
Remote Command:	[:SENSE]:ROSCillator:SOURce:TYPE INTernal EXTernal SENSE [:SENSE]:ROSCillator:SOURce:TYPE?

Preset:	This is unaffected by a Preset but is set to SENSE on a "Restore Input/Output Defaults" or "Restore System Defaults->All".
State Saved:	Saved in instrument state.
Status Bits/OPC dependencies:	STATUS:QUESTIONable:FREQUENCY bit 2 set if unlocked.
Backwards Compatibility Notes:	Freq Ref In was not saved in state in the legacy instruments. It is a part of state in the X-Series.
Initial S/W Revision:	Prior to A.02.00

Remote Command:	[:SENSe] :ROSCillator :SOURce?
Notes:	<p>The query [SENSe]:ROSCillator:SOURce? returns the current switch setting. This means:</p> <ol style="list-style-type: none"> 1. If it was set to SENSE but there is no external reference so the instrument is actually using the internal reference, then this query returns INTERNAL and not SENSE. 2. If it was set to SENSE and there is an external reference present, the query returns EXTERNAL and not SENSE. 3. If it was set to EXTERNAL, then the query returns "EXTERNAL" 4. If it was set to INTERNAL, then the query returns "INTERNAL"
Preset:	SENSE
Backwards Compatibility Notes:	<p>The query [:SENSe]:ROSCillator:SOURce? was a query-only command in ESA which always returned whichever reference the instrument was using. The instrument automatically switched to the ext ref if it was present.</p> <p>In PSA (which had no sensing) the command [:SENSe]:ROSCillator:SOURce set the reference (INT or EXT), so again its query returned the actual routing.</p> <p>Thus the query form of this command is 100% backwards compatible with both instruments.</p>
Initial S/W Revision:	Prior to A.02.00

Remote Command:	[:SENSe] :ROSCillator :SOURce INTERNAL EXTERNAL
Notes:	For PSA compatibility the command form is provided and is directly mapped to [:SENSe]:ROSCillator:SOURce:TYPE
Initial S/W Revision:	Prior to A.02.00

Sense

The external reference is used if a valid signal is sensed at the Ext Ref input. Otherwise the internal reference is used.

Key Path:	Input/Output, Freq Ref In
Example:	:ROSC:SOUR:TYPE SENS

Common Measurement Functions 1

Readback:	Sense
Initial S/W Revision:	Prior to A.02.00

Internal

The internal reference is used.

Key Path:	Input/Output, Freq Ref In
Example:	:ROSC:SOUR:TYPE INT
Readback:	Internal
Initial S/W Revision:	Prior to A.02.00

External

The external reference is used.

Key Path:	Input/Output, Freq Ref In
Example:	:ROSC:SOUR:TYPE EXT
Readback:	External
Initial S/W Revision:	Prior to A.02.00

Ext Ref Freq

This key tells the analyzer the frequency of the external reference. When the external reference is in use (either because the reference has been switched to External or because the Reference has been switched to Sense and there is a valid external reference present) this information is used by the analyzer to determine the internal settings needed to lock to that particular external reference signal.

For the instrument to stay locked, the value entered must be within 5 ppm of the actual external reference frequency. So it is important to get it close, or you risk an unlock condition.

Note that this value only affects the instrument's ability to lock. It does not affect any calculations or measurement results. See "Freq Offset" in the Frequency section for information on how to offset frequency values.

Key Path:	Input/Output, Freq Ref In
Remote Command:	[:SENSe]:ROSCillator:EXTernal:FREQuency <freq> [:SENSe]:ROSCillator:EXTernal:FREQuency?
Example:	ROSC:EXT:FREQ 20 MHz sets the external reference frequency to 20 MHz, but does not select the external reference. ROSC:SOUR:TYPE EXT selects the external reference.
Notes:	Still available with Internal selected, to allow setup for when External is in use.

Preset:	This is unaffected by a Preset but is set to 10 MHz on a "Restore Input/Output Defaults" or "Restore System Defaults->All"
Min:	CXA: 10 MHz EXA: 10 MHz or 13 MHz, depending on whether N9010A-R13 is licensed MXA: 1 MHz PXA: 1 MHz
Max:	CXA: 10 MHz EXA: 10 MHz MXA: 50 MHz PXA: 50 MHz
Default Unit:	Hz
Initial S/W Revision:	Prior to A.02.00

External Reference Lock BW

This control lets you adjust the External Reference phase lock bandwidth. This control is available in some models of the X-Series.

The PXA variable reference loop bandwidth allows an external reference to be used and have the analyzer close-in phase noise improved to match that of the reference. This could result in an improvement of tens of decibels. The choice of "Wide" or "Narrow" affects the phase noise at low offset frequencies, especially 4 to 400 Hz offset. When using an external reference with superior phase noise, we recommend setting the external reference phase-locked-loop bandwidth to wide (60 Hz), to take advantage of that superior performance. When using an external reference with inferior phase noise performance, we recommend setting that bandwidth to narrow (15 Hz). In these relationships, inferior and superior phase noise are with respect to 134 dBc/Hz at 30 Hz offset from a 10 MHz reference. Because most reference sources have phase noise behavior that falls off at a rate of 30 dB/decade, this is usually equivalent to 120 dBc/Hz at 10 Hz offset.

Key Path:	Input/Output, Freq Ref In
Scope:	Mode Global
Remote Command:	[:SENSe]:ROSCillator:BANDwidth WIDE NARROW [:SENSe]:ROSCillator:BANDwidth?
Example:	ROSC:BAND WIDE
Dependencies:	This key only appears in analyzers equipped with the required hardware.
Preset:	This is unaffected by a Preset but is set to Narrow on a "Restore Input/Output Defaults" or "Restore System Defaults -> All"
State Saved:	Saved in Input/Output state.
Initial S/W Revision:	A.04.00

Common Measurement Functions 1

External Ref Coupling

Only appears with option ERC installed and licensed.

This function lets you couple the sweep system of the analyzer to the state of the External Reference. If **Normal** is selected, data acquisition proceeds regardless of the state of the External Reference. When you select **Ext Ref Out Of Range Stops Acquisition**, the data acquisition (sweep or measurement) stops when either the "521, External ref out of range" or the "503, Frequency Reference unlocked" error message is asserted. Note that this will only take place if the **Freq Ref In** selection is **External**.

With the acquisition stopped, the data display will stop updating (even if this occurs in the middle of a sweep or measurement) and no data will be returned to a READ? or MEASure? query; that is, these queries will not complete because the analyzer will not respond to them. Furthermore, no response will be generated to a *WAI? or *OPC? query.

Proper SCPI sequences are shown below, which will always fail to return if the acquisition stops during the requested sweep or measurement. Note that, for predictable operation of this function, it is best to operate the analyzer in single measurement mode (INIT:CONT OFF), because if operating in continuous mode, the analyzer may respond to the above queries even after the acquisition stops, with data left over from the previous acquisition.

```
:INIT:CONT OFF
```

```
:INIT:IMM;*OPC?
```

```
--
```

```
:INIT:CONT OFF
```

```
:INIT:IMM;*WAI?
```

```
--
```

```
:INIT:CONT OFF
```

```
:READ?
```

```
--
```

```
:INIT:CONT OFF
```

```
:MEASure?
```

When the acquisition ceases, in addition to the error condition(s) described above, a popup error message will be generated informing you that the acquisition has ceased due to an invalid external reference. This message will stay on the screen while the acquisition is suspended.

External reference problem.
 Data acquisition suspended.
 To resume data acquisition, fix the
 problem and press the Restart key
 OR
 Press the following keys:
 Input/Output, More 1 of 2, Freq Ref In,
 External Ref Coupling, Normal
 OR
 Input/Output, More 1 of 2,
 Freq Ref In, Internal

If you press the Restart key this message will be taken off the screen and a new acquisition will be attempted; if the External Reference problem persists the message will go right back up. You can also take the message down by changing back to the **Normal** setting of Sweep/Ext Ref Coupling, or by pressing **Freq Ref In, Internal**, or **Freq Ref In, Sense**, or **Restore Input/Output Defaults**.

The setting of **External Ref Coupling** is persistent across power-cycling and is not reset with a Preset. It is reset to the default state (**Normal**) when **Restore Input/Output Defaults** is invoked, which will also restart normal data acquisition.

The detection of invalid external reference is under interrupt processing. If the external reference becomes invalid then returns to valid in too short a time, no error condition will be detected or reported and therefore the acquisition will not be stopped.

Key Path:	Input/Output, Freq Ref In
Mode:	All
Remote Command:	[:SENSE]:ROSCillator:COUPling NORMAl NACquisition [:SENSE]:ROSCillator:COUPling?
Preset:	This setting is persistent: it survives power-cycling or a Preset and is reset with Restore Input/Output defaults.
State Saved:	Not saved in instrument state
Readback:	Normal Stop Acq
Initial S/W Revision:	A.02.00

Output Config

Accesses keys that configure various output settings, like the frequency reference output, trigger output and analog output.

Key Path:	Input/Output
-----------	---------------------

Common Measurement Functions 1

Backwards Compatibility Notes:	In ESA there was not a user interface to enable the Video Output (Analog Output), Trigger Output, or Gate Output. In the X-Series each of these physical connectors requires configuration, thus the user interface has been added for X-Series, along with the potential for an output you think is always on to be switched off.
Initial S/W Revision:	Prior to A.02.00

Trig Out (1 and 2)

Select the type of output signal that will be output from the rear panel Trig 1 Out or Trig 2 Out connectors.

Key Path:	Input/Output, Output Config
Remote Command:	:TRIGger TRIGger1 TRIGger2 [:SEQuence] :OUTPut HSWP MEASuring MAIN GATE GTRigger OEVEN SPOint SSweep S SETtled S1Marker S2Marker S3Marker S4Marker OFF :TRIGger TRIGger1 TRIGger2 [:SEQuence] :OUTPut?
Example:	TRIG:OUTP HSWP TRIG2:OUTP GATE
Dependencies:	The second Trigger output (Trig 2 Out) does not appear in all models; in models that do not support it, the Trig 2 Out key is blanked, and sending the SCPI command for this output generates an error, "Hardware missing; Not available for this model number" In models that do not support the Trigger 2 output, this error is returned if trying to set Trig 2 Out and a query of Trig 2 Out returns OFF.
Preset:	Trigger 1: Sweeping (HSWP) Trigger 2: Gate This is unaffected by a Preset but is preset to the above values on a "Restore Input/Output Defaults" or "Restore System Defaults->All"
State Saved:	Saved in instrument state
Initial S/W Revision:	Prior to A.02.00

Off

Selects no signal to be output to the Trig 1 Out or Trig 2 Out connector.

Key Path:	Input/Output, Output Config, Trig 1/2 Output
Example:	TRIG1:OUTP OFF
Readback:	Off
Initial S/W Revision:	Prior to A.02.00

Polarity

Sets the output to the Trig 1 Out or Trig 2 Out connector to trigger on either the positive or negative polarity.

Key Path:	Input/Output, Output Config, Trig 1/2 Output
Remote Command:	:TRIGger TRIGger1 TRIGger2[:SEQuence]:OUTPut:POLarity POSitive NEGative :TRIGger TRIGger1 TRIGger2[:SEQuence]:OUTPut:POLarity?
Example:	TRIG1:OUTP:POL POS
Preset:	This is unaffected by a Preset but is set to POSitive on a "Restore Input/Output Defaults" or "Restore System Defaults->All"
State Saved:	Saved in instrument state
Initial S/W Revision:	Prior to A.02.00

Sweeping (HSWP)

Selects the Sweeping Trigger signal to be output to the Trig 1 Out or Trig 2 Out connector when a measurement is made. This signal has historically been known as "HSWP" (High = Sweeping), and is 5 V TTL level with 50 ohm output impedance."

Key Path:	Input/Output, Output Config, Trig 1/2 Output
Example:	TRIG1:OUTP HSWP
Readback:	Sweeping
Initial S/W Revision:	Prior to A.02.00

Measuring

Selects the Measuring trigger signal to be output to the Trig 1 Out or Trig 2 Out connector. This signal is true while the Measuring status bit is true.

Key Path:	Input/Output, Output Config, Trig 1/2 Output
Example:	TRIG1:OUTP MEAS
Readback:	Measuring
Initial S/W Revision:	Prior to A.02.00

Main Trigger

Selects the current instrument trigger signal to be output to the Trig 1 Out or Trig 2 Out connector.

Key Path:	Input/Output, Output Config, Trig 1/2 Output
Example:	TRIG1:OUTP MAIN
Readback:	Main Trigger

Common Measurement Functions 1

Initial S/W Revision:	Prior to A.02.00
-----------------------	------------------

Gate Trigger

Selects the gate trigger signal to be output to the Trig 1 Out or Trig 2 Out connector. This is the source of the gate timing, not the actual gate signal.

Key Path:	Input/Output, Output Config, Trig 1/2 Output
Example:	TRIG1:OUTP GTR
Readback:	Gate Trigger
Initial S/W Revision:	Prior to A.02.00

Gate

Selects the gate signal to be output to the Trig 1 Out or Trig 2 Out connector. The gate signal has been delayed and its length determined by delay and length settings. When the polarity is positive, a high on the Trig 1 Out or Trig 2 Out represents the time the gate is configured to pass the signal.

Key Path:	Input/Output, Output Config, Trig 1/2 Output
Example:	TRIG1:OUTP GATE
Readback:	Gate
Initial S/W Revision:	Prior to A.02.00

Odd/Even Trace Point

Selects either the odd or even trace points as the signal to be output to the Trig 1 Out or Trig 2 Out connector when performing swept spectrum analysis. When the polarity is positive, this output goes high during the time the analyzer is sweeping past the first point (Point 0) and every other following trace point. The opposite is true if the polarity is negative.

Key Path:	Input/Output, Output Config, Trig 1/2 Output
Example:	TRIG1:OUTP OEV
Readback:	Odd/Even
Initial S/W Revision:	Prior to A.02.00

Analog Out

This menu lets you control which signal is fed to the “Analog Out” connector on the analyzer rear panel.

See [“More Information” on page 1499](#)

Key Path:	Input/Output, Output Config
Remote Command:	:OUTPut:ANALog OFF SVIDeo LOGVideo LINVideo DAUDio :OUTPut:ANALog?

Example:	OUTP:ANAL SVIDeo causes the analog output type to be Screen Video
Preset:	OFF
Preset:	This is unaffected by Preset but is set to DAUDio on a "Restore Input/Output Defaults" or "Restore System Defaults->All
State Saved:	Saved in Input/Output State
Readback line:	1-of-N selection [variable]
Backwards Compatibility Notes:	<p>Prior to A.04.00, OFF was the default functionality except when in the Analog Demod application or with Tune and Listen, in which case it was DAUDio, and there was no selection menu. So for backwards compatibility with earlier X-Series firmware versions, Auto (:OUTP:ANAL:AUTO ON) will duplicate the prior behavior.</p> <p>The DNWB and SANalyzer parameters, which were legal in PSA but perform no function in the X-Series, are accepted without error.</p>
Initial S/W Revision:	A.04.00

More Information

The table below gives the range for each output.

Analog Out	Nominal Range exc. (10% overrange)	Scale Factor	Notes
Off	0 V		
Screen Video	0 – 1 V open circuit	10%/division	8566 compatible
Log Video	0 – 1 V terminated	1/(192.66 dB/V)	dB referenced to mixer level, 1V out for –10 dBm at the mixer.
Linear Video	0 – 1 V terminated	100%/V	Linear referenced to Ref Level, 1 V out for RF envelope at the Ref Level.
Demod Audio	(varies with analyzer setting)		

Auto

Selects the Auto state for the Analog Output menu. In this state, the Analog Output will automatically be set to the most sensible setting for the current mode or measurement.

If you make a selection manually from the Analog Out menu, this selection will remain in force until you change it (or re-select Auto), even if you go to a mode or measurement for which the selected output does not apply.

Key Path:	Input/Output, Output Config, Analog Out
Remote Command:	OUTPut:ANALog:AUTO OFF ON 0 1 OUTPut:ANALog:AUTO?

Common Measurement Functions 1

Example:	OUTP:ANAL:AUTO ON
Preset:	ON
State Saved:	Saved in Input/Output State
Initial S/W Revision:	A.04.00

Off

Turns off the analog output.

Key Path:	Input/Output, Output Config, Analog Out
Example:	OUTP:ANAL OFF causes the analog output to be off
Readback Text:	Off
Initial S/W Revision:	A.04.00

Screen Video

Selects the analog output to be the screen video signal. In this mode, the pre-detector data is output to the Analog Out connector. The output looks very much like the trace displayed on the analyzer's screen, and depends on the Log/Lin display Scale, Reference Level, and dB per division, but is not influenced by the selected detector or any digital flatness corrections or trace post-processing (like Trace Averaging).

Note that this mode is similar to the Analog Output of the HP 8566 family and the Video Out (opt 124) capability of the Agilent PSA analyzer (E444x), although there are differences in the behavior.

Key Path:	Input/Output, Output Config, Analog Out
Example:	OUTP:ANAL SVID

Dependencies:	<p>Because the Screen Video output uses one of the two IF processing channels, only one detector is available while Screen Video is selected. All active traces will change to use the same detector as the selected trace when Screen Video is activated.</p> <p>Screen Video output is not available while any EMI Detector is selected (Quasi Peak, RMS Average or EMI Average), because these detectors use both IF processing channels. Consequently, if the user chooses an EMI Detector, there will be no Screen Video output.</p> <p>The output holds at its last value during an alignment and during a marker count. After a sweep:</p> <ul style="list-style-type: none"> • If a new sweep is to follow (as in Continuous sweep mode), the output holds at its last value during the retrace before the next sweep starts. If the analyzer is in zero-span, there is no retrace, as the analyzer remains tuned to the Center Frequency and does not sweep. Therefore, in zero-span, the output simply remains live between display updates. • If no new sweep is to follow (as in Single sweep mode), the output remains live, and continues to show the pre-detector data. <p>This function depends on optional capability; the key will be blanked and the command will generate an “Option not available” error unless you have Option YAV or YAS licensed in your instrument.</p>
Couplings:	Screen Video output changes while in FFT Sweeps, so for measurements that use exclusively FFT Sweeps, or if the user manually chooses FFT Sweeps, the Screen Video output will look different than it does in swept mode.
Readback Text:	Screen Video
Backwards Compatibility Notes:	See “Backwards Compatibility:” on page 1501 , below.
Initial S/W Revision:	A.04.00

Backwards Compatibility:

The Screen Video function is intended to be very similar to the 8566 Video Output and the PSA Option 124. However, unlike the PSA, it is not always on; it must be switched on by the Screen Video key. Also, unlike the PSA, there are certain dependencies (detailed above) – for example, the Quasi Peak Detector is unavailable when Screen Video is on.

Furthermore, the PSA Option 124 hardware was unipolar and its large range was padded to be exactly right for use as a Screen Video output. In the X-Series, the hardware is bipolar and has a wider range to accommodate the other output choices. Therefore, the outputs won’t match up exactly and users may have to modify their setup when applying the X-Series in a PSA application.

Log Video (RF Envelope, Ref=Mixer Level)

Selects the analog output to be the log of the video signal. In this mode, the pre-detector data is output to the Analog Out connector with a Log scaling. The output is referenced to the current level at the mixer, does not depend on display settings like Reference Level or dB per division, and it is not influenced by the selected detector or any digital flatness corrections or trace post-processing (like Trace Averaging), but does change with input attenuation.

The output is designed so that full scale (1 V) corresponds to –10 dBm at the mixer. The full range (0–1 V) covers

Common Measurement Functions 1

192.66 dB; thus, 0 V corresponds to –202.66 dBm at the mixer.

Key Path:	Input/Output, Output Config, Analog Out
Example:	OUTP:ANAL LOGV
Dependencies:	<p>Because the Log Video output uses one of the two IF processing channels, only one detector is available while Screen Video is selected. All active traces will change to use the same detector as the selected trace when Log Video is activated.</p> <p>Log Video output is not available while any EMI Detector is selected (Quasi Peak, RMS Average or EMI Average), because these detectors use both IF processing channels. Consequently, if the user chooses an EMI Detector, there will be no Log Video output.</p> <p>The output holds at its last value during an alignment, during a marker count, and during retrace (after a sweep and before the next sweep starts).</p> <p>This function depends on optional capability. The key will be blanked and the command will generate an “Option not available” error unless you have Option YAV licensed in your instrument.</p>
Couplings:	Log Video output changes while in FFT Sweeps, so for measurements that use exclusively FFT Sweeps, or if the user manually chooses FFT Sweeps, the Log Video output will look different than it does in swept mode.
Readback Text:	Log Video
Initial S/W Revision:	A.04.00

Linear Video (RF Envelope, Ref=Ref Level)

Selects the analog output to be the envelope signal on a linear (voltage) scale. In this mode, the pre-detector data is output to the Analog Out connector with a Linear scaling. The output is based on the current Reference Level, and is not influenced by the selected detector or any digital flatness corrections or trace post-processing (like Trace Averaging).

The scaling is set so that 1 V output occurs with an instantaneous video level equal to the reference level, and 0 V occurs at the bottom of the graticule. This scaling gives you the ability to control the gain without having another setup control for the key. But it requires you to control the look of the display (the reference level) in order to control the analog output.

This mode is ideal for looking at Amplitude Modulated signals, as the linear envelope effectively demodulates the signal.

Key Path:	Input/Output, Output Config, Analog Out
Example:	OUTP:ANAL LINV

Dependencies:	<p>Because the Linear Video output uses one of the two IF processing channels, only one detector is available while Linear Video is selected. All active traces will change to use the same detector as the selected trace when Log Video is activated.</p> <p>Linear Video output is not available while any EMI Detector is selected (Quasi Peak, RMS Average or EMI Average), because these detectors use both IF processing channels. Consequently, if the user chooses an EMI Detector, there will be no Linear Video output.</p> <p>The output holds at its last value during an alignment and during a marker count and during retrace (after a sweep and before the next sweep starts).</p> <p>This function depends on optional capability; the key will be blanked and the command will generate an “Option not available” error unless you have Option YAV licensed in your instrument.</p>
Couplings:	Linear Video output changes while in FFT Sweeps, so for measurements that use exclusively FFT Sweeps, or if the user manually chooses FFT Sweeps, the Linear Video output will look different than it does in swept mode.
Readback Text:	Linear Video
Initial S/W Revision:	A.04.00

Demod Audio

Selects the analog output to be the demodulation of the video signal.

When Demod Audio is selected, the demodulated audio signal appears at this output whenever the Analog Demod application is demodulating a signal or when **Analog Demod Tune and Listen** is operating in the Swept SA measurement.

When Analog Out is in the Auto state, this output is auto-selected when in the Analog Demod mode or when **Analog Demod Tune and Listen** is operating in the Swept SA measurement.

If any other Analog Output is manually selected when in the Analog Demod mode or when **Analog Demod Tune and Listen** is operating in the Swept SA measurement, a condition warning message appears.

Key Path:	Input/Output, Output Config, Analog Out
Example:	OUTP:ANAL DAUD
Dependencies:	<p>This key only appears if the Analog Demod application (N9063A), the N6141A or W6141A application, or Option EMC is installed and licensed, otherwise the key will be blanked and the command will generate an “Option not available” error.</p> <p>The output holds at its last value during an alignment and during a marker count. It is not held between sweeps, in order for Tune and Listen to work properly.</p> <p>When Demod Audio is the selected Analog Output:</p> <ul style="list-style-type: none"> • all active traces are forced to use the same detector. • CISPR detectors (QPD, EMI Avg, RMS Avg) are unavailable
Readback Text:	Demod Audio

Common Measurement Functions 1

Initial S/W Revision:	Prior to A.02.00 (this was the default functionality, and there was no selection)
Modified at S/W Revision:	A.04.00

Digital Bus

This menu allows you to configure the LVDS connector located on the rear panel of the instrument. It is a unidirectional link of real time data at a 90 MSa/s rate. The ADC is sampling a 22.5 MHz IF.

The data that appears on this port is raw, uncorrected ADC samples, unless you have option RTL. With option RTL, you get fully corrected I/Q data.

This connector will only be active when the Narrowband IF Path is currently in use.

Key Path:	Input/Output, Output Config, Digital Out
Initial S/W Revision:	A.04.00

I/Q Cal Out

The Baseband I/Q "Cal Out" port can be turned on with either a 1 kHz or a 250 kHz square wave. This can be turned on independent of the input selection. A Preset will reset this to Off.

Key Path:	Input/Output, Output Config
Remote Command:	:OUTPut : IQ:OUTPut IQ1 IQ250 OFF :OUTPut : IQ:OUTPut ?
Example:	OUTP:IQ:OUTP IQ1
Couplings:	An I/Q Cable Calibration or an I/Q Probe Calibration will change the state of the Cal Out port as needed by the calibration routine. When the calibration is finished the I/Q Cal Out is restored to the pre-calibration state.
Preset:	Off
State Saved:	Saved in instrument state.
Range:	1 kHz Square Wave 250 kHz Square Wave Off
Readback Text:	1 kHz 250 kHz Off
Initial S/W Revision:	Prior to A.02.00
Saved State:	Saved in instrument state

1 kHz Square Wave

Turns on the 1 kHz square wave signal at the Cal Out port. This choice is only available with option BBA.

Key Path:	Input/Output, Output Config, I/Q Cal Out
Readback:	I/Q 1kHz
Initial S/W Revision:	Prior to A.02.00

250 kHz Square Wave

Turns on the 250 kHz square wave signal at the Cal Out port. This choice is only available with option BBA.

Key Path:	Input/Output, Output Config, I/Q Cal Out
Readback:	I/Q 250kHz
Initial S/W Revision:	Prior to A.02.00

Off

Turns off the signal at the Cal Out port. This choice is only available with option BBA.

Key Path:	Input/Output, Output Config, I/Q Cal Out
Readback:	Off
Initial S/W Revision:	Prior to A.02.00

Bus Out On/Off

When Bus Out is on, all acquisitions are streamed to the output port including acquisitions for internal purposes such as Alignment; internal processing and routing of acquisitions continues as usual and is unaffected by the state of Bus Out.

When Bus Out is off, no signal appears on the LVDS port.

Key Path:	Input/Output, Output Config, Digital Out, Digital Bus
Scope:	Mode Global
Remote Command:	:OUTPut:DBUS[1][:STATe] ON OFF 1 0 :OUTPut:DBUS[1][:STATe]?
Example:	OUTP:DBUS ON
Preset:	This is unaffected by a Preset but is set to Off on a "Restore Input/Output Defaults" or "Restore System Defaults -> All"
State Saved:	Saved in Input/Output State
Initial S/W Revision:	Prior to A.02.00
Modified at S/W Revision:	A.04.00

Aux IF Out

This menu controls the signals that appear on the SMA output on the rear panel labeled "AUX IF OUT"

The Aux IF Out functionality is only valid for RF and External Mixer inputs. When using the External Mixing path, the Aux IF Out levels (for all three Options CR3, CRP, and ALV) will be uncalibrated because the factory default Aux IF level was set to accommodate the expected IF levels for the RF path.

Key Path:	Input/Output, Output Config
-----------	------------------------------------

Common Measurement Functions 1

Remote Command:	:OUTPut:AUX SIF AIF LOGVideo OFF :OUTPut:AUX?
Dependencies:	The softkey does not appear in models that do not support the Aux IF Out.
Preset:	This is unaffected by a Preset but is set to OFF on a "Restore Input/Output Defaults" or "Restore System Defaults->All"
State Saved:	Saved in Input/Output state
Readback line:	1-of-N selection [variable]
Backwards Compatibility Notes:	In the PSA, the IF output has functionality equivalent to the "Second IF" function in the X-Series' Aux IF Out menu. In the X-Series, it is necessary to switch the Aux IF Out to "Second IF" to get this functionality, whereas in PSA it is always on, since there are no other choices. Hence a command to switch this function to "Second IF" will have to be added by customers migrating from PSA who use the IF Output in PSA.
Initial S/W Revision:	A.04.00

Second IF

In this mode the 2nd IF output is routed to the rear panel connector. The annotation on the key shows the current 2nd IF frequency in use in the analyzer.

The frequency of the 2nd IF depends on the current IF signal path as shown in the table below:

IF Path Selected	Frequency of "Second IF" Output
10 MHz	322.5 MHz
25 MHz	322.5 MHz
40 MHz	250 MHz
140 MHz	300 MHz

The signal quality, such as signal to noise ratio and phase noise, are excellent in this mode.

Key Path:	Input/Output, Output Config, Aux IF Out
Example:	OUTP:AUX SIF causes the aux output type to be Second IF
Dependencies:	Does not appear unless Option CR3 is installed.
Readback Text:	Second IF
Initial S/W Revision:	A.04.00

Arbitrary IF

In this mode the 2nd IF output is mixed with a local oscillator and mixer to produce an arbitrary IF output between

10 MHz and 75 MHz with 500 kHz resolution. The phase noise in this mode will not be as good as in **Second IF** mode.

The IF output frequency is adjustable, through an active function which appears on the Arbitrary IF selection key, from 10 MHz to 75 MHz with 500 kHz resolution.

The bandwidth of this IF output varies with band and center frequency, but is about 40 MHz at the -3 dB width. When the output is centered at lower frequencies in its range, signal frequencies at the bottom of the bandwidth will “fold”. For example, with a 40 MHz bandwidth (20 MHz half-bandwidth), and a 15 MHz IF center, a signal -20 MHz relative to the spectrum analyzer center frequency will have a relative response of about -3 dB with a frequency 20 MHz below the 15 MHz IF center. This -5 MHz frequency will fold to become a +5 MHz signal at the IF output. Therefore, lower IF output frequencies are only useful with known band-limited signals.

Key Path:	Input/Output, Output Config, Aux IF Out
Example:	OUTP:AUX AIF causes the aux output type to be the Arbitrary IF
Dependencies:	Does not appear unless Option CRP is installed.
Readback Text:	Arbitrary IF
Initial S/W Revision:	A.04.00

Key Path:	Input/Output, Output Config, Aux IF Out
Scope:	Mode Global
Remote Command:	:OUTPut:AUX:AIF <value> :OUTPut:AUX:AIF?
Example:	:OUTP:AUX:AIF 50 MHZ
Preset:	This is unaffected by a Preset but is set to 70 MHz on a "Restore Input/Output Defaults" or "Restore System Defaults->All"
State Saved:	Saved in Input/Output State
Min:	10 MHz
Max:	75 MHz
Default Unit:	Hz
Initial S/W Revision:	A.04.00

Fast Log Video

In this mode the 2nd IF output is passed through a log amp and the log envelope of the IF signal is sent to the rear panel. The open circuit output level varies by about 25 mV per dB, with a top-of-screen signal producing about 1.6 Volts. The output impedance is nominally 50 ohms.

This mode is intended to meet the same needs as Option E4440A-H7L Fast Rise Time Video Output on the Agilent E4440A PSA Series, allowing you to characterize pulses with fast rise times using standard measurement suites on

Common Measurement Functions 1

modern digital scopes.

Key Path:	Input/Output, Output Config, Aux IF Out
Example:	OUTP:AUX LOGVideo causes the aux output type to be Fast Log Video
Dependencies:	Does not appear unless Option ALV is installed. The output is off during an alignment but not during a marker count, and is not blanked during retrace (after a sweep and before the next sweep starts).
Readback Text:	Fast Log Video
Initial S/W Revision:	A.04.00

Off

In this mode nothing comes out of the “AUX IF OUT” connector on the rear panel. The connector appears as an open-circuit (that is, it is not terminated in any way).

Key Path:	Input/Output, Output Config, Aux IF Out
Example:	OUTP:AUX OFF causes the aux output type to be off
Readback Text:	Off
Initial S/W Revision:	A.04.00

I/Q Guided Calibration

Calibrating the Baseband I/Q ports requires several steps and manual connections. The Guided Calibration will interactively step a user through the required steps, displaying diagrams to help with the connections. The steps will vary depending on the setup.

In the Guided Calibration windows, the date and time of the last calibration are displayed. If any of the items listed are displayed in yellow, this indicates that the calibration for that item is inconsistent with the latest calibration, and you should complete the entire calibration process before you exit the calibration.

I/Q Isolation Calibration

The I/Q Isolation Calibration must be run before calibrating any port with either the I/Q Cable Calibration or I/Q Probe Calibration. This calibration is performed with nothing connected to any of the front panel I/Q ports. This is the first step in both the I/Q Cable Calibration and the I/Q Probe Calibration.

Next

Perform the I/Q Isolation calibration.

Key Path:	Input/Output, I/Q, I/Q Cable Calibration
Remote Command:	:CALibration:IQ:ISOLation

Example:	CAL:IQ:ISOL
Notes:	All front panel I/Q ports must not be connected to anything.
Notes:	All cables and probes should be disconnected from the I/Q ports before issuing the SCPI command.
State Saved:	No.
Initial S/W Revision:	Prior to A.02.00

Exit

Exits the calibration procedure. All ports calibrated before pressing Exit will use the newly acquired calibration data.

Key Path:	Input/Output, I/Q, I/Q Cable Calibration
Notes:	Using the Exit button will not restore the calibration data to the state prior to entering the guided calibration. Once a port is calibrated the data is stored immediately and the only way to change it is to redo the calibration step. When the calibration may be left in an inconsistent state, a confirmation dialog will be displayed (see “Exit Confirmation” on page 1520).
Initial S/W Revision:	Prior to A.02.00

I/Q Isolation Calibration Time (Remote Command Only)

Returns the last date and time that the I/Q Isolation Calibration was performed. This is a remote query command only.

Remote Command:	:CALibration:IQ:ISOLation:TIME?
Example:	:CAL:IQ:ISOL:TIME?
Notes:	This returns 6 integer values: year, month, day, hour, minute, second. When no calibration has been performed, all values will be 0.
Initial S/W Revision:	A.02.00

I/Q Cable Calibrate...

The I/Q cable calibration creates correction data for each of the front panel I/Q ports. This calibration data is used whenever no probe specific calibration data is available. It is important that all ports are calibrated using the same short BNC cable so that the data is comparable from port to port.

The guided calibration (front panel only) will show connection diagrams and guide the user through the isolation calibration and calibrating each port. The calibration data for each port is stored separately, so as soon as a port is calibrated that data is saved and will be used. If a user presses "Exit" to exit the calibration process, the data for the ports already completed will still be used. It is recommended that a calibration be completed once started, or if exited, that it be properly done before the next use of the I/Q ports. The "Next" button will perform the calibration for the current port and then proceed to the next step in the calibration procedure. The "Back" button will return to the prior port in the procedure. Both softkeys and dialog buttons are supplied for ease of use. The dialog buttons are for mouse use and the

Common Measurement Functions 1

softkeys for front panel use.

The calibration can also be done via SCPI, but no connection diagrams will be shown. The user will have to make the correct connections before issuing each port calibration command. Again, it is recommended that all ports be calibrated at the same time.

The instrument state remains as it was prior to entering the calibration procedure except while a port is actually being calibrated. Once a port is calibrated it returns to the prior state. A port calibration is in process only from the time the "Next" button is pressed until the next screen is shown. For SCPI, this corresponds to the time from issuing the CAL:IQ:FLAT:I|IB|Q|QB command until the operation is complete.

For example, if the prior instrument state is Cal Out = Off, Input = I+jQ, and Differential = Off, then up until the time the "Next" button is pressed the I Input and Q Input LEDs are on and the Cal Out, I-bar Input and Q-bar Input LEDs are off. Once the "Next" button is pressed for the I port calibration, only the Cal Out and I Input LEDs will be on and the others will be off. When the screen progresses to the next step ("Next" button again enabled), the prior state is restored and only the I Input and Q Input LEDs are on (Cal Out is off again).

The last calibration date and time for each port will be displayed. Any calibrations that are more than a day older than the most recent calibration will be displayed with the color amber.

Key Path:	Input/Output, I/Q
Initial S/W Revision:	Prior to A.02.00

I Port

The I port calibration is performed with the front panel's I port connected via a short BNC cable to the Cal Out port. The guided calibration will show a diagram of the required connections.

Back

Return to the prior step in the calibration procedure.

Key Path:	Input/Output, I/Q, Q Setup, Q Probe, Calibrate
Initial S/W Revision:	Prior to A.02.00

Next

Perform the I port calibration.

Key Path:	Input/Output, I/Q, I/Q Cable Calibrate...
Remote Command:	:CALibration:IQ:FLATness:I
Example:	CAL:IQ:FLAT:I
Notes:	The recommended procedure is to use the same BNC cable to calibrate all I/Q ports. All I/Q ports should be calibrated sequentially during the procedure. The calibration data is saved as soon as the port is calibrated and will survive power cycles. It is not reset by any preset or restore data commands.

Notes:	The I port must be connected to the Cal Out port before issuing the SCPI command.
State Saved:	No.
Initial S/W Revision:	Prior to A.02.00

Exit

Exit the calibration procedure. All ports calibrated before pressing Exit will use the newly acquired calibration data.

Key Path:	Input/Output, I/Q, I/Q Cable Calibrate...
Notes:	Using the Exit button will not restore the calibration data to the state prior to entering the guided calibration. Once a port is calibrated the data is stored immediately and the only way to change it is to redo the calibration step. When the calibration may be left in an inconsistent state, a confirmation dialog will be displayed (see “Exit Confirmation” on page 1520).
Initial S/W Revision:	Prior to A.02.00

I-bar Port

The I-bar port calibration is performed with the front panel's I-bar port connected via a short BNC cable to the Cal Out port. The guided calibration will show a diagram of the required connections.

Back

Return to the prior step in the calibration procedure.

Key Path:	Input/Output, I/Q, I/Q Cable Calibration
Notes:	Using the Back button will not restore the calibration data to a prior state. Once a port is calibrated the data is stored immediately and the only way to change it is to redo the calibration step. The Back button allows the user to go back to a prior step to redo that calibration step.
Initial S/W Revision:	Prior to A.02.00

Next

Perform the I-bar port calibration.

Key Path:	Input/Output, I/Q, I/Q Cable Calibrate...
Remote Command:	:CALibration:IQ:FLATness:IBAR
Example:	CAL:IQ:FLAT:IBAR
Notes:	The recommended procedure is to use the same BNC cable to calibrate all I/Q ports. All I/Q ports should be calibrated sequentially during the procedure. The calibration data is saved as soon as the port is calibrated and will survive power cycles. It is not reset by any preset or restore data commands.

Common Measurement Functions 1

Notes:	The I-bar port must be connected to the Cal Out port before issuing the SCPI command.
State Saved:	No
Initial S/W Revision:	Prior to A.02.00

Exit

Exit the calibration procedure. All ports calibrated before pressing Exit will use the newly acquired calibration data.

Key Path:	Input/Output, I/Q, I/Q Cable Calibrate...
Notes:	Using the Exit button will not restore the calibration data to the state prior to entering the guided calibration. Once a port is calibrated the data is stored immediately and the only way to change it is to redo the calibration step. When the calibration may be left in an inconsistent state, a confirmation dialog will be displayed (see “Exit Confirmation” on page 1520).
Initial S/W Revision:	Prior to A.02.00

Q Port

The Q port calibration is performed with the front panel's Q port connected via a short BNC cable to the Cal Out port. The guided calibration will show a diagram of the required connections.

Back

Return to the prior step in the calibration procedure.

Key Path:	Input/Output, I/Q, I/Q Cable Calibrate...
Notes:	Using the Back button will not restore the calibration data to a prior state. Once a port is calibrated the data is stored immediately and the only way to change it is to redo the calibration step. The Back button allows the user to go back to a prior step to redo that calibration step.
Initial S/W Revision:	Prior to A.02.00

Next

Perform the Q port calibration.

Key Path:	Input/Output, I/Q, I/Q Cable Calibrate...
Remote Command:	<code>:CALibration:IQ:FLATness:Q</code>
Example:	<code>CAL:IQ:FLAT:Q</code>
Notes:	The recommended procedure is to use the same BNC cable to calibrate all I/Q ports. All I/Q ports should be calibrated sequentially during the procedure. The calibration data is saved as soon as the port is calibrated and will survive power cycles. It is not reset by any preset or restore data commands.

Notes:	The Q port must be connected to the Cal Out port before issuing the SCPI command.
State Saved:	No
Initial S/W Revision:	Prior to A.02.00

Exit

Exit the calibration procedure. All ports calibrated before pressing Exit will use the newly acquired calibration data.

Key Path:	Input/Output, I/Q, I/Q Cable Calibrate...
Notes:	Using the Exit button will not restore the calibration data to the state prior to entering the guided calibration. Once a port is calibrated the data is stored immediately and the only way to change it is to redo the calibration step. When the calibration may be left in an inconsistent state, a confirmation dialog will be displayed (see “Exit Confirmation” on page 1520).
Initial S/W Revision:	Prior to A.02.00

Q-bar Port

The Q-bar port calibration is performed with the front panel's Q-bar port connected via a short BNC cable to the Cal Out port. The guided calibration will show a diagram of the required connections.

Back

Return to the prior step in the calibration procedure.

Key Path:	Input/Output, I/Q, I/Q Cable Calibrate...
Notes:	Using the Back button will not restore the calibration data to a prior state. Once a port is calibrated the data is stored immediately and the only way to change it is to redo the calibration step. The Back button allows the user to go back to a prior step to redo that calibration step.
Initial S/W Revision:	Prior to A.02.00

Next

Perform the Q-bar port calibration.

Key Path:	Input/Output, I/Q, I/Q Cable Calibrate...
Remote Command:	:CALibration:IQ:FLATness:QBAR
Example:	CAL:IQ:FLAT:QBAR
Notes:	The recommended procedure is to use the same BNC cable to calibrate all I/Q ports. All I/Q ports should be calibrated sequentially during the procedure. The calibration data is saved as soon as the port is calibrated and will survive power cycles. It is not reset by any preset or restore data commands.

Common Measurement Functions 1

Notes:	The Q-bar port must be connected to the Cal Out port before issuing the SCPI command.
State Saved:	No
Initial S/W Revision:	Prior to A.02.00

Exit

Exit the calibration procedure. All ports calibrated before pressing Exit will use the newly acquired calibration data.

Key Path:	Input/Output, I/Q, I/Q Cable Calibrate...
Notes:	Using the Exit button will not restore the calibration data to the state prior to entering the guided calibration. Once a port is calibrated the data is stored immediately and the only way to change it is to redo the calibration step. When the calibration may be left in an inconsistent state, a confirmation dialog will be displayed (see “Exit Confirmation” on page 1520).
Initial S/W Revision:	Prior to A.02.00

I/Q Cable Calibration Time (Remote Command Only)

Returns the last date and time that the I/Q Cable Calibration was performed for a specific port. This is a remote query command only.

Remote Command:	:CALibration:IQ:FLATness:I IBAR Q QBAR:TIME?
Example:	:CAL:IQ:FLAT:I:TIME?
Notes:	This returns 6 integer values: year, month, day, hour, minute, second. When no calibration has been performed, all values will be 0.
Initial S/W Revision:	A.02.00

I/Q Probe Calibration

The I/Q probe calibration creates correction data for one of the front panel I/Q channels. When the probe has EEPROM identification, the data is unique to that specific probe. When the probe does not have EEPROM identification, the data will be used for all probes of the same type. The data is also unique to the channel, so calibration data for the I channel will not be used for the Q channel and vice versa.

The guided calibration (front panel only) will show connection diagrams and guide the user through the I/Q Isolation Calibration and through calibrating each port. The calibration data for each port is stored separately, so as soon as a port is calibrated that data is saved and will be used. If a user presses "Exit" to exit the calibration process, the data for the port already completed will still be used. It is recommended that a calibration be completed once started, or if exited, that it be properly done before the next use of the probe. The "Next" button will perform the calibration for the current port and then proceed to the next step in the calibration procedure. The "Back" button will return to the prior port in the procedure. Both softkeys and dialog buttons are supplied for ease of use. The dialog buttons are for mouse use and the softkeys for front panel use.

The calibration can also be done via SCPI, but no connection diagrams will be shown. The user will have

to make the correct connections before issuing each port calibration command. Again, it is recommended that all ports be calibrated at the same time.

For Active probes or when Differential is Off, only the main port is calibrated, otherwise both the main and complementary ports are calibrated.

The instrument state remains as it was prior to entering the calibration procedure except while a port is actually being calibrated. Once a port is calibrated it returns to the prior state. A port calibration is in process only from the time the "Next" button is pressed until the next screen is shown. For SCPI, this corresponds to the time from issuing the CAL:IQ:PROB:I|IB|Q|QB command until the operation is complete.

For example, if the prior instrument state is Cal Out = Off, Input = I+jQ, and Differential = Off, then up until the time the "Next" button is pressed the I Input and Q Input LEDs are on and the Cal Out, I-bar Input and Q-bar Input LEDs are off. Once the "Next" button is pressed for the I port calibration, only the Cal Out and I Input LEDs will be on and the others will be off. When the screen progresses to the next step ("Next" button again enabled), the prior state is restored and only the I Input and Q Input LEDs are on (Cal Out is off again).

The last calibration date and time for each relevant port will be displayed. For passive probes with Differential On, any calibration that is more than a day older than the most recent calibration will be displayed with the color amber.

I Port

The I port calibration is performed with the probe body attached to the front panel's I port and the probe tip connected via an adapter to the Cal Out port. The guided calibration will show a diagram of the required connections.

Show Adapter

Show a connection diagram and instructions for the probe and adapter. See ["Show Adapter Screen" on page 1519](#).

Key Path:	Input/Output, I/Q, I Setup, I Probe, Calibrate
Notes:	Either a passive or an active probe adapter diagram will be shown, depending on the type of probe attached.
Initial S/W Revision:	Prior to A.02.00

Back

Return to the prior step in the calibration procedure.

Key Path:	Input/Output, I/Q, Q Setup, Q Probe, Calibrate
Initial S/W Revision:	Prior to A.02.00

Next

Perform the I port calibration.

Key Path:	Input/Output, I/Q, I Setup, I Probe, Calibrate
Remote Command:	:CALibration:IQ:PROBe:I

Common Measurement Functions 1

Example:	CAL:IQ:PROB:I
Notes:	The I port must be connected to the Cal Out port before issuing the SCPI command. The calibration data is saved as soon as the port is calibrated and will survive power cycles. It is not reset by any preset or restore data commands.
State Saved:	No
Initial S/W Revision:	Prior to A.02.00

Exit

Exit the calibration procedure. All ports calibrated before pressing Exit will use the newly acquired calibration data.

Key Path:	Input/Output, I/Q, I Setup, I Probe, Calibrate
Notes:	Using the Exit button will not restore the calibration data to the state prior to entering the guided calibration. Once a port is calibrated the data is stored immediately and the only way to change it is to redo the calibration step. When the calibration may be left in an inconsistent state, a confirmation dialog will be displayed (see “Exit Confirmation” on page 1520).
Initial S/W Revision:	Prior to A.02.00

I-bar Port

The I-bar port calibration is performed with the probe body attached to the front panel's I-bar port and the probe tip connected via an adapter to the Cal Out port. The I-bar probe calibration is only available for passive probes with Differential On. The guided calibration will show a diagram of the required connections.

Show Adapter

Show a connection diagram and instructions for the probe and adapter. See [“Show Adapter Screen” on page 1519](#).

Key Path:	Input/Output, I/Q, I Setup, I Probe, Calibrate
Notes:	Either a passive or an active probe adapter diagram will be shown, depending on the type of probe attached.
Initial S/W Revision:	Prior to A.02.00

Back

Return to the prior step in the calibration procedure.

Key Path:	Input/Output, I/Q, I Setup, I Probe, Calibrate
Notes:	Using the Back button will not restore the calibration data to a prior state. Once a port is calibrated the data is stored immediately and the only way to change it is to redo the calibration step. The Back button allows the user to go back to a prior step to redo that calibration step.
Initial S/W Revision:	Prior to A.02.00

Next

Perform the I-bar port calibration.

Key Path:	Input/Output, I/Q, I Setup, I Probe, Calibrate
Remote Command:	:CALibration:IQ:PROBe:IBar
Example:	CAL:IQ:PROB:IB
Notes:	The I-bar port must be connected to the Cal Out port before issuing the SCPI command. The calibration data is saved as soon as the port is calibrated and will survive power cycles. It is not reset by any preset or restore data commands.
State Saved:	No
Initial S/W Revision:	Prior to A.02.00

Exit

Exit the calibration procedure. All ports calibrated before pressing Exit will use the newly acquired calibration data.

Key Path:	Input/Output, I/Q, I Setup, I Probe, Calibrate
Notes:	Using the Exit button will not restore the calibration data to the state prior to entering the guided calibration. Once a port is calibrated the data is stored immediately and the only way to change it is to redo the calibration step. When the calibration may be left in an inconsistent state, a confirmation dialog will be displayed (see “Exit Confirmation” on page 1520).
Initial S/W Revision:	Prior to A.02.00

Q Port

The Q port calibration is performed with the probe body attached to the front panel's Q port and the probe tip connected via an adapter to the Cal Out port. The guided calibration will show a diagram of the required connections.

Show Adapter

Show a connection diagram and instructions for the probe and adapter. See [“Show Adapter Screen”](#) on page 1519.

Key Path:	Input/Output, I/Q, Q Setup, Q Probe, Calibrate
Notes:	Either a passive or an active probe adapter diagram will be shown, depending on the type of probe attached.
Initial S/W Revision:	Prior to A.02.00

Common Measurement Functions 1

Back

Return to the prior step in the calibration procedure.

Key Path:	Input/Output, I/Q, Q Setup, Q Probe, Calibrate
Initial S/W Revision:	Prior to A.02.00

Next

Perform the Q port calibration.

Key Path:	Input/Output, I/Q, Q Setup, Q Probe, Calibrate
Remote Command:	:CALibration:IQ:PROBe:Q
Example:	CAL:IQ:PROB:Q
Notes:	The Q port must be connected to the Cal Out port before issuing the SCPI command. The calibration data is saved as soon as the port is calibrated and will survive power cycles. It is not reset by any preset or restore data commands.
State Saved:	No
Initial S/W Revision:	Prior to A.02.00

Exit

Exit the calibration procedure. All ports calibrated before pressing Exit will use the newly acquired calibration data.

Key Path:	Input/Output, I/Q, Q Setup, Q Probe, Calibrate
Notes:	Using the Exit button will not restore the calibration data to the state prior to entering the guided calibration. Once a port is calibrated the data is stored immediately and the only way to change it is to redo the calibration step. When the calibration may be left in an inconsistent state, a confirmation dialog will be displayed (see “Exit Confirmation” on page 1520).
Initial S/W Revision:	Prior to A.02.00

Q-bar Port

The Q-bar port calibration is performed with the probe body attached to the front panel's Q-bar port and the probe tip connected via an adapter to the Cal Out port. The Q-bar probe calibration is only available for passive probes with Differential On. The guided calibration will show a diagram of the required connections.

Show Adapter

Show a connection diagram and instructions for the probe and adapter. See [“Show Adapter Screen” on page 1519](#).

Key Path:	Input/Output, I/Q, Q Setup, Q Probe, Calibrate
-----------	---

Notes:	Either a passive or an active probe adapter diagram will be shown, depending on the type of probe attached.
Initial S/W Revision:	Prior to A.02.00

Back

Return to the prior step in the calibration procedure.

Key Path:	Input/Output, I/Q, Q Setup, Q Probe, Calibrate
Notes:	Using the Back button will not restore the calibration data to a prior state. Once a port is calibrated the data is stored immediately and the only way to change it is to redo the calibration step. The Back button allows the user to go back to a prior step to redo that calibration step.
Initial S/W Revision:	Prior to A.02.00

Next

Perform the Q-bar port calibration.

Key Path:	Input/Output, I/Q, Q Setup, Q Probe, Calibrate
Remote Command:	:CALibration:IQ:PROBe:QBar
Example:	CAL:IQ:PROB:QB
Notes:	The Q-bar port must be connected to the Cal Out port before issuing the SCPI command. The calibration data is saved as soon as the port is calibrated and will survive power cycles. It is not reset by any preset or restore data commands.
State Saved:	No
Initial S/W Revision:	Prior to A.02.00

Exit

Exit the calibration procedure. All ports calibrated before pressing Exit will use the newly acquired calibration data.

Key Path:	Input/Output, I/Q, Q Setup, Q Probe, Calibrate
Notes:	Using the Exit button will not restore the calibration data to the state prior to entering the guided calibration. Once a port is calibrated the data is stored immediately and the only way to change it is to redo the calibration step. When the calibration may be left in an inconsistent state, a confirmation dialog will be displayed (see “Exit Confirmation” on page 1520).
Initial S/W Revision:	Prior to A.02.00

Show Adapter Screen

When one of the Probe Calibration Show Adapter buttons is pressed, a diagram of the probe with its adapter will be

Common Measurement Functions 1

shown. Depending on the type of probe attached, either the Passive Probe Adapter or the Active Probe Adapter diagram will be shown.

I/Q Probe Calibration Time (Remote Command Only)

Return the last date and time that the I/Q Probe Calibration was performed for a specific port. This is a remote query command only.

Remote Command:	:CALibration:IQ:PROBE:I IBAR Q QBAR:TIME?
Example:	:CAL:IQ:PROB:I:TIME?
Notes:	This returns 6 integer values: year, month, day, hour, minute, second. When no calibration has been performed, all values will be 0. The value is specific to both the port and probe, so the value will change as probes are connected or disconnected.
Initial S/W Revision:	A.02.00

Exit Confirmation

When Exit is pressed during one of the calibration routines, the calibration may be in an inconsistent state with some of the ports having newly measured calibration data and others with old data. If this is the case, a dialog box will appear to confirm that the user really wants to exit. A "Yes" answer will exit the calibration procedure, leaving potentially inconsistent calibration data in place. A "No" answer will return to the calibration procedure.

Meas

The information in this section is common to all measurements. For key and remote command information for a specific measurement, refer to the section that describes the measurement of interest.

Measurements available under the Meas key are specific to the current Mode.

When viewing Help for measurements, note the following:

NOTE	Operation for some keys differs between measurements. The information displayed in Help pertains to the current measurement. To see how a key operates in a different measurement, exit Help (press the Cancel Esc key), select the measurement, then reenter Help (press the Help key) and press that key.
-------------	---

Key Path:	Front-panel key
Initial S/W Revision:	Prior to A.02.00

Remote Measurement Functions

This section contains the following topics:

[“Measurement Group of Commands” on page 1522](#)

“Current Measurement Query (Remote Command Only) ” on page 1524

“Limit Test Current Results (Remote Command Only)” on page 1525

“Data Query (Remote Command Only)” on page 1525

“Calculate/Compress Trace Data Query (Remote Command Only)” on page 1525

“Calculate Peaks of Trace Data (Remote Command Only)” on page 1530

“Format Data: Numeric Data (Remote Command Only)” on page 1532

“Format Data: Byte Order (Remote Command Only)” on page 1534

Initial S/W Revision:	Prior to A.02.00
-----------------------	------------------

Common Measurement Functions 1

Measurement Group of Commands

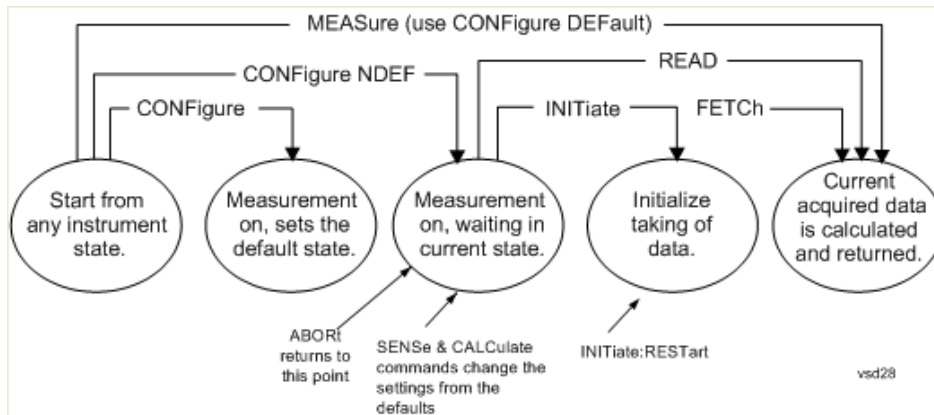

Measure Commands:

:MEASure:<measurement>[n]?

This is a fast single-command way to make a measurement using the factory default instrument settings. These are the settings and units that conform to the Mode Setup settings (e.g. radio standard) that you have currently selected.

- Stops the current measurement (if any) and sets up the instrument for the specified measurement using the factory defaults
- Initiates the data acquisition for the measurement
- Blocks other SCPI communication, waiting until the measurement is complete before returning results.
- If the function does averaging, it is turned on and the number of averages is set to 10.
- After the data is valid it returns the scalar results, or the trace data, for the specified measurement. The type of data returned may be defined by an [n] value that is sent with the command. The scalar measurement results will be returned if the optional [n] value is not included, or is set to 1. If the [n] value is set to a value other than 1, the selected trace data results will be returned. See each command for details of what types of scalar results or trace data results are available.

ASCII is the default format for the data output. (Older versions of Spectrum Analysis and Phase Noise mode measurements only use ASCII.) The binary data formats should be used for handling large blocks of data since they are smaller and faster than the ASCII format. Refer to the FORMat:DATA command for more information.

If you need to change some of the measurement parameters from the factory default settings you can set up the measurement with the CONFIgure command. Use the commands in the SENSE:<measurement> and CALCulate:<measurement> subsystems to change the settings. Then you can use the READ? command to initiate the measurement and query the results.

If you need to repeatedly make a given measurement with settings other than the factory defaults, you can use the commands in the SENSE:<measurement> and CALCulate:<measurement> subsystems to set up the measurement. Then use the READ? command to initiate the measurement and query results.

Measurement settings persist if you initiate a different measurement and then return to a previous one. Use READ:<measurement>? if you want to use those persistent settings. If you want to go back to the default settings, use MEASure:<measurement>?.

Measure Commands:
Configure Commands:
<p>:CONFigure:<measurement></p> <p>This command stops the current measurement (if any) and sets up the instrument for the specified measurement using the factory default instrument settings. It does not initiate the taking of measurement data unless INIT:CONTInuous is ON. If you change any measurement settings after using the CONFigure command, the READ command can be used to initiate a measurement without changing the settings back to their defaults.</p> <p>In the Swept SA measurement in Spectrum Analyzer mode the CONFigure command also turns the averaging function on and sets the number of averages to 10 for all measurements.</p> <p>:CONFigure:NDEFault<measurement> stops the current measurement and changes to the specified measurement. It does not change the settings to the defaults. It does not initiate the taking of measurement data unless INIT:CONTInuous is ON.</p> <p>The CONFigure? query returns the current measurement name.</p> <p>The CONFigure:CATalog? query returns a quoted string of all measurement names in the current mode. For example, "SAN, CHP, OBW, ACP, PST, TXP, SPUR, SEM, LIST".</p>
Fetch Commands:
<p>:FETCh:<measurement>[n]?</p> <p>This command puts selected data from the most recent measurement into the output buffer. Use FETCh if you have already made a good measurement and you want to return several types of data (different [n] values, for example, both scalars and trace data) from a single measurement. FETCh saves you the time of re-making the measurement. You can only FETCh results from the measurement that is currently active, it will not change to a different measurement. An error message is reported if a measurement other than the current one is specified.</p> <p>If you need to get new measurement data, use the READ command, which is equivalent to an INITiate followed by a FETCh.</p> <p>The scalar measurement results will be returned if the optional [n] value is not included, or is set to 1. If the [n] value is set to a value other than 1, the selected trace data results will be returned. See each command for details of what types of scalar results or trace data results are available. The binary data formats should be used for handling large blocks of data since they are smaller and transfer faster than the ASCII format. (FORMat:DATA)</p> <p>FETCh may be used to return results other than those specified with the original READ or MEASure command that you sent.</p>
INITiate Commands:

Common Measurement Functions 1

Measure Commands:	
:INITiate:<measurement>	
This command is not available for measurements in all the instrument modes:	
<ul style="list-style-type: none">• Initiates a trigger cycle for the specified measurement, but does not output any data. You must then use the FETCh<meas> command to return data. If a measurement other than the current one is specified, the instrument will switch to that measurement and then initiate it.• For example, suppose you have previously initiated the ACP measurement, but now you are running the channel power measurement. If you send INIT:ACP? it will change from channel power to ACP and will initiate an ACP measurement.• Does not change any of the measurement settings. For example, if you have previously started the ACP measurement and you send INIT:ACP? it will initiate a new ACP measurement using the same instrument settings as the last time ACP was run.• If your selected measurement is currently active (in the idle state) it triggers the measurement, assuming the trigger conditions are met. Then it completes one trigger cycle. Depending upon the measurement and the number of averages, there may be multiple data acquisitions, with multiple trigger events, for one full trigger cycle. It also holds off additional commands on GPIB until the acquisition is complete.	
READ Commands:	
:READ:<measurement>[n]?	
<ul style="list-style-type: none">• Does not preset the measurement to the factory default settings. For example, if you have previously initiated the ACP measurement and you send READ:ACP? it will initiate a new measurement using the same instrument settings.• Initiates the measurement and puts valid data into the output buffer. If a measurement other than the current one is specified, the instrument will switch to that measurement before it initiates the measurement and returns results.	
For example, suppose you have previously initiated the ACP measurement, but now you are running the channel power measurement. Then you send READ:ACP? It will change from channel power back to ACP and, using the previous ACP settings, will initiate the measurement and return results.	
<ul style="list-style-type: none">• Blocks other SCPI communication, waiting until the measurement is complete before returning the results	
If the optional [n] value is not included, or is set to 1, the scalar measurement results will be returned. If the [n] value is set to a value other than 1, the selected trace data results will be returned. See each command for details of what types of scalar results or trace data results are available. The binary data formats should be used when handling large blocks of data since they are smaller and faster than the ASCII format. (FORMat:DATA)	

Initial S/W Revision:	Prior to A.02.00
-----------------------	------------------

Current Measurement Query (Remote Command Only)

This command returns the name of the measurement that is currently running.

Remote Command:	:CONFigure?
------------------------	-------------

Example:	CONF?
Initial S/W Revision:	Prior to A.02.00

Limit Test Current Results (Remote Command Only)

Queries the status of the current measurement limit testing. It returns a 0 if the measured results pass when compared with the current limits. It returns a 1 if the measured results fail any limit tests.

Remote Command:	:CALCulate:CLIMits:FAIL?
Example:	CALC:CLIM:FAIL? queries the current measurement to see if it fails the defined limits. Returns a 0 or 1: 0 it passes, 1 it fails.
Initial S/W Revision:	Prior to A.02.00

Data Query (Remote Command Only)

Returns the designated measurement data for the currently selected measurement and subopcode.

n = any valid subopcode for the current measurement. See the measurement command results table for your current measurement, for information about what data is returned for the subopcodes.

This command uses the data setting specified by the FORMat:BORDER and FORMat:DATA commands and can return real or ASCII data. (See the format command descriptions under Input/Output in the Analyzer Setup section.)

Remote Command:	:CALCulate:DATA[n]?
Notes:	The return trace depends on the measurement. In CALCulate:<meas>:DATA[n], n is any valid subopcode for the current measurement. It returns the same data as the FETCh:<measurement>? query where <measurement> is the current measurement.
Initial S/W Revision:	Prior to A.02.00

Calculate/Compress Trace Data Query (Remote Command Only)

Returns compressed data for the currently selected measurement and sub-opcode [n].

n = any valid sub-opcode for that measurement. See the MEASure:<measurement>? command description of your specific measurement for information on the data that can be returned.

The data is returned in the current Y Axis Unit of the analyzer. The command is used with a sub-opcode <n> (default=1) to specify the trace. With trace queries, it is best if the analyzer is not sweeping during the query. Therefore, it is generally advisable to be in Single Sweep, or Update=Off.

This command is used to compress or decimate a long trace to extract and return only the desired data. A typical example would be to acquire N frames of GSM data and return the mean power of the first burst

Common Measurement Functions 1

in each frame. The command can also be used to identify the best curve fit for the data.

Remote Command:	:CALCulate:DATA<n>:COMPress? BLOCk CFIT MAXimum MINimum MEAN DMEan RMS RMSCubed SAMP le SDEVIation PPHase [,<soffset>[,<length>[,<roffset>[,<rlimit>]]]]
Example:	To query the mean power of a set of GSM bursts: Supply a signal that is a set of GSM bursts. Select the IQ Waveform measurement (in IQ Analyzer Mode). Set the sweep time to acquire at least one burst. Set the triggers such that acquisition happens at a known position relative to a burst. Then query the mean burst levels using, CALC:DATA2:COMP? MEAN,24e-6,526e-6 (These parameter values correspond to GSM signals, where 526e-6 is the length of the burst in the slot and you just want 1 burst.)
Notes:	The command supports 5 parameters. Note that the last 4 (<soffset>,<length>,<roffset>,<rlimit>) are optional. But these optional parameters must be entered in the specified order. For example, if you want to specify <length>, then you must also specify <soffset>. See details below for a definition of each of these parameters. This command uses the data in the format specified by FORMat:DATA, returning either binary or ASCII data.
Initial S/W Revision:	Prior to A.02.00

- BLOCk or block data - returns all the data points from the region of the trace data that you specify. For example, it could be used to return the data points of an input signal over several timeslots, excluding the portions of the trace data that you do not want. (This is x,y pairs for trace data and I,Q pairs for complex data.)
- CFIT or curve fit - applies curve fitting routines to the data. <soffset> and <length> are required to define the data that you want. <roffset> is an optional parameter for the desired order of the curve equation. The query will return the following values: the x-offset (in seconds) and the curve coefficients ((order + 1) values).

MIN, MAX, MEAN, DME, RMS, RMSC, SAMP, SDEV and PPH return one data value for each specified region (or <length>) of trace data, for as many regions as possible until you run out of trace data (using <roffset> to specify regions). Or they return the number of regions you specify (using <rlimit>) ignoring any data beyond that.

- MINimum - returns the minimum data point (x,y pair) for the specified region(s) of trace data. For I/Q trace data, the minimum magnitude of the I/Q pairs is returned.
- MAXimum - returns the maximum data point (x,y pair) for the specified region(s) of trace data. For I/Q trace data, the maximum magnitude of the I/Q pairs is returned.

NOTE MEAN - returns a single value that is the arithmetic mean of the data point values

(in dB/ dBm) for the specified region(s) of trace data. For I/Q trace data, the mean of the magnitudes of the I/Q pairs is returned. See the following equations.

If the original trace data is in dB, this function returns the arithmetic mean of those log values, not log of the mean power which is a more useful value. The mean of the log is the better measurement technique when measuring CW signals in the presence of noise. The mean of the power, expressed in dB, is useful in power measurements such as Channel Power. To achieve the mean of the power, use the RMS option.

Equation 1

Mean Value of Data Points for Specified Region(s)

$$\text{MEAN} = \frac{1}{n} \sum_{X_i \in \text{region}(s)} X_i \quad \text{vsd27-1}$$

where X_i is a data point value, and n is the number of data points in the specified region(s).

Equation 2

Mean Value of I/Q Data Pairs for Specified Region(s)

$$\text{MEAN} = \frac{1}{n} \sum_{X_i \in \text{region}(s)} |X_i| \quad \text{vsd27-2}$$

where $|X_i|$ is the magnitude of an I/Q pair, and n is the number of I/Q pairs in the specified region(s).

- DMEan - returns a single value that is the mean power (in dB/ dBm) of the data point values for the specified region(s) of trace data. See the following equation:

Equation 3

DMEan Value of Data Points for Specified Region(s)

$$\text{DME} = 10 \times \log_{10} \left(\frac{1}{n} \sum_{X_i \in \text{region}(s)} 10^{\frac{X_i}{10}} \right) \quad \text{vsd27-3}$$

- RMS - returns a single value that is the average power on a root-mean-squared voltage scale (arithmetic rms) of the data point values for the specified region(s) of trace data. See the following equation.

NOTE

For I/Q trace data, the rms of the magnitudes of the I/Q pairs is returned. See the following equation.

This function is very useful for I/Q trace data. However, if the original trace data is in dB, this function returns the rms of the log values which is not usually needed.

Equation 4

Common Measurement Functions 1

RMS Value of Data Points for Specified Region(s)

$$\text{RMS} = \sqrt{\frac{1}{n} \sum_{X_i \in \text{region}(s)} X_i^2}$$

vsd27-4

where X_i is a data point value, and n is the number of data points in the specified region(s).

Equation 5

RMS Value of I/Q Data Pairs for Specified Region(s)

$$\text{RMS} = \sqrt{\frac{1}{n} \sum_{X_i \in \text{region}(s)} X_i X_i^*}$$

vsd27-5

where X_i is the complex value representation of an I/Q pair, X_i^* its conjugate complex number, and n is the number of I/Q pairs in the specified region(s).

Once you have the rms value for a region of trace data (linear or I/Q), you may want to calculate the mean power. You must convert this rms value (peak volts) to power in dBm:

$$10 \times \log[10 \times (\text{rms value})^2]$$

- **SAMPLE** - returns the first data value (x,y pair) for the specified region(s) of trace data. For I/Q trace data, the first I/Q pair is returned.
- **SDEViation** - returns a single value that is the arithmetic standard deviation for the data point values for the specified region(s) of trace data. See the following equation.

For I/Q trace data, the standard deviation of the magnitudes of the I/Q pairs is returned. See the following equation.

Equation 6

Standard Deviation of Data Point Values for Specified Region(s)

$$\text{SDEV} = \sqrt{\frac{1}{n} \sum_{X_i \in \text{region}(s)} (X_i - \bar{X})^2}$$

vsd27-7

where X_i is a data point value, \bar{X} is the arithmetic mean of the data point values for the specified region(s), and n is the number of data points in the specified region(s).

$$\text{SDEV} = \sqrt{\frac{1}{n} \sum_{X_i \in \text{region}(s)} (|X_i| - \bar{X})^2}$$

vsd27-8

where $|X_i|$ is the magnitude of an I/Q pair, \bar{X} is the mean of the magnitudes for the specified region(s), and n is the number of data points in the specified region(s).

- **PPHase** - returns the x,y pairs of both rms power (dBm) and arithmetic mean phase (radian) for every

specified region and frequency offset (Hz). The number of pairs is defined by the specified number of regions. This parameter can be used for I/Q vector (n=0) in Waveform (time domain) measurement and all parameters are specified by data point in PPHase.

The rms power of the specified region may be expressed as:

$$\text{Power} = 10 \times \log [10 \times (\text{RMS I/Q value})] + 10.$$

The RMS I/Q value (peak volts) is:

$$\sqrt{\frac{1}{n} \sum_{X_i \in \text{region}} X_i X_i^*}$$

vsd27-9

where X_i is the complex value representation of an I/Q pair, X_i^* its conjugate complex number, and n is the number of I/Q pairs in the specified region.

The arithmetic mean phase of the specified region may be expressed as:

$$\frac{1}{n} \sum_{Y_i \in \text{region}} Y_i$$

vsd27-10

where Y_i is the unwrapped phase of I/Q pair with applying frequency correction and n is the number of I/Q pairs in the specified region.

The frequency correction is made by the frequency offset calculated by the arithmetic mean of every specified region's frequency offset. Each frequency offset is calculated by the least square method against the unwrapped phase of I/Q pair.

Sample Trace Data - Constant Envelope

(See below for explanation of variables.)

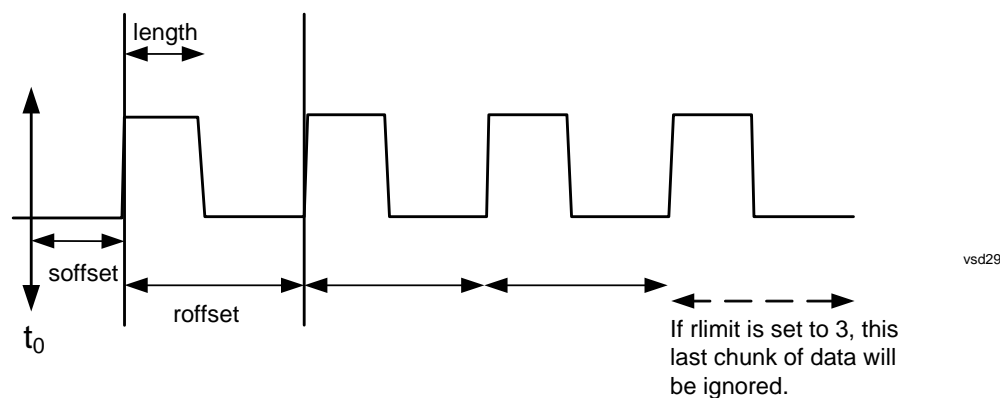

Sample Trace Data - Not Constant Envelope

(See below for explanation of variables.)

Common Measurement Functions 1

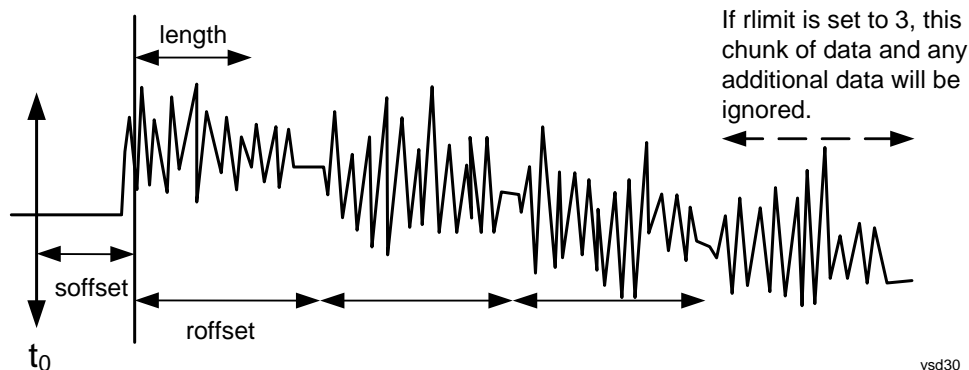

<soffset> - start offset is an optional real number. (It is in seconds for time-domain traces, and is a dimensionless index 0 to Npoints - 1, for frequency-domain traces). It specifies the amount of data at the beginning of the trace that will be ignored before the decimation process starts. It is the time or frequency change from the start of the trace to the point where you want to start using the data. The default value is zero.

<length> - is an optional real number. (It is in seconds for time-domain traces, and is a dimensionless index 0 to Npoints - 1, for frequency-domain traces). It defines how much data will be compressed into one value. This parameter has a default value equal to the current trace length.

<roffset> - repeat offset is an optional real number. (It is in seconds for time-domain traces, and is a dimensionless index 0 to Npoints - 1, for frequency-domain traces). It defines the beginning of the next field of trace elements to be compressed. This is relative to the beginning of the previous field. This parameter has a default value equal to the <length> variable. Note that this parameter is used for a completely different purpose when curve fitting (see CFIT above).

<rlimit> - repeat limit is an optional integer. It specifies the number of data items that you want returned. It will ignore any additional items beyond that number. You can use the Start offset and the Repeat limit to pick out exactly what part of the data you want to use. The default value is all the data.

Calculate Peaks of Trace Data (Remote Command Only)

Returns a list of all the peaks for the currently selected measurement and sub-opcode [n]. The peaks must meet the requirements of the peak threshold and excursion values.

n = any valid sub-opcode for the current measurement. See the MEASure:<measurement> command description of your specific measurement for information on the data that can be returned.

The command can only be used with specific sub-opcodes with measurement results that are trace data. Both real and complex traces can be searched, but complex traces are converted to magnitude in dBm. In many measurements the sub-opcode n=0, is the raw trace data which cannot be searched for peaks. And Sub-opcode n=1, is often calculated results values which also cannot be searched for peaks.

This command uses the data setting specified by the FORMat:BORDER and FORMat:DATA commands and can return real or ASCII data. If the format is set to INT,32, it returns REAL,32 data.

The command has four types of parameters:

- Threshold (in dBm)
- Excursion (in dB)

- Sorting order (amplitude, frequency, time)
- Optional in some measurements: Display line use (all, > display line, < display line)

<p>Remote Command:</p>	<p>For Swept SA measurement:</p> <pre>:CALCulate:DATA[1] 2 3 4 5 6 :PEAKs? <threshold> , <excursion> [, AMPLitude FREQuency TIME [, ALL GTDLine LTDLine]]</pre> <p>For most other measurements:</p> <pre>:CALCulate:DATA[1] 2 3 4 5 6 :PEAKs? <threshold> , <excursion> [, AMPLitude FREQuency TIME]</pre>
<p>Example:</p>	<p>Example for Swept SA measurement in Spectrum Analyzer Mode:</p> <p>CALC:DATA4:PEAK? -40,10,FREQ,GTDL This will identify the peaks of trace 4 that are above -40 dBm, with excursions of at least 10 dB. The peaks are returned in order of increasing frequency, starting with the lowest frequency. Only the peaks that are above the display line are returned.</p> <p>Query Results 1:</p> <p>With FORMat:DATA REAL,32 selected, it returns a list of floating-point numbers. The first value in the list is the number of peak points that are in the following list. A peak point consists of two values: a peak amplitude followed by its corresponding frequency (or time).</p> <p>If no peaks are found the peak list will consist of only the number of peaks, (0).</p>

Common Measurement Functions 1

Notes:	<p><n> - is the trace that will be used</p> <p><threshold> - is the level below which trace data peaks are ignored. Note that the threshold value is required and is always used as a peak criterion. To effectively disable the threshold criterion for this command, provide a substantially low threshold value such as -200 dBm. Also note that the threshold value used in this command is independent of and has no effect on the threshold value stored under the Peak Criteria menu.</p> <p><excursion> - is the minimum amplitude variation (rise and fall) required for a signal to be identified as peak. Note that the excursion value is required and is always used as a peak criterion. To effectively disable the excursion criterion for this command, provide the minimum value of 0.0 dB. Also note that the excursion value used in this command is independent of and has no effect on the excursion value stored under the Peak Criteria menu.</p> <p>Values must be provided for threshold and excursion. The sorting and display line parameters are optional (defaults are AMPLitude and ALL).</p> <p>Note that there is always a Y-axis value for the display line, regardless of whether the display line state is on or off. It is the current Y-axis value of the display line which is used by this command to determine whether a peak should be reported</p> <p>Sorting order:</p> <p>AMPLitude - lists the peaks in order of descending amplitude, with the highest peak first (default if optional parameter not sent)</p> <p>FREQUENCY - lists the peaks in order of occurrence, left to right across the x-axis.</p> <p>TIME - lists the peaks in order of occurrence, left to right across the x-axis.</p> <p>Peaks vs. Display Line:</p> <p>ALL - lists all of the peaks found (default if optional parameter not sent).</p> <p>GTDLIne (greater than display line) - lists all of the peaks found above the display line.</p> <p>LTDLine (less than display line) - lists all of the peaks found below the display line.</p>
Initial S/W Revision:	Prior to A.02.00

Format Data: Numeric Data (Remote Command Only)

This command specifies the format of the trace data input and output. It specifies the formats used for trace data during data transfer across any remote port. It affects only the data format for setting and querying trace data for the :TRACe[:DATA], TRACe[:DATA]?, :CALCulate:DATA[n]? and FETCh:SANalyzer[n]? commands and queries.

Remote Command:	<pre>:FORMat [:TRACe] [:DATA] ASCii INTeger, 32 REAL, 32 REAL, 64 :FORMat [:TRACe] [:DATA] ?</pre>
------------------------	--

Notes:	<p>The query response is:</p> <p>ASCii: ASC,8</p> <p>REAL,32: REAL,32</p> <p>REAL,64: REAL,64</p> <p>INTeger,32: INT,32</p> <p>When the numeric data format is REAL or ASCii, data is output in the current Y Axis unit. When the data format is INTeger, data is output in units of m dBm (.001 dBm).</p> <p>The INT,32 format returns binary 32-bit integer values in internal units (m dBm), in a definite length block.</p>
Dependencies:	<p>Sending a data format spec with an invalid number (for example, INT,48) generates no error. The analyzer simply uses the default (8 for ASCii, 32 for INTeger, 32 for REAL).</p> <p>Sending data to the analyzer which does not conform to the current FORMat specified, results in an error. Sending ASCII data when a definite block is expected generates message -161 "Invalid Block Data" and sending a definite block when ASCII data is expected generates message -121 "Invalid Character in Number".</p>
Preset:	ASCii
Backwards Compatibility Notes:	Note that the INT,32 format is only applicable to the command, TRACe:DATA. This preserves backwards compatibility for the Swept SA measurement. For all other commands/queries which honor FORMat:DATA, if INT,32 is sent the analyzer will behave as though it were set to REAL,32.
Initial S/W Revision:	Prior to A.02.00

The specs for each output type follow:

ASCii - Amplitude values are in ASCII, in the current Y Axis Unit, one ASCII character per digit, values separated by commas, each value in the form:

SX.YYYYYEsZZ

Where:

S = sign (+ or -)

X = one digit to left of decimal point

Y = 5 digits to right of decimal point

E = E, exponent header

s = sign of exponent (+ or -)

ZZ = two digit exponent

REAL,32 - Binary 32-bit real values in the current Y Axis Unit, in a definite length block.

REAL,64 - Binary 64-bit real values in the current Y Axis Unit, in a definite length block.

Common Measurement Functions 1

Format Data: Byte Order (Remote Command Only)

This command selects the binary data byte order for data transfer and other queries. It controls whether binary data is transferred in normal or swapped mode. This command affects only the byte order for setting and querying trace data for the :TRACe[:DATA], TRACe[:DATA]? , :CALCulate:DATA[n]? and FETCh:SANalyzer[n]? commands and queries.

By definition any command that says it uses FORMat:DATA uses any format supported by FORMat:DATA.

The NORMal order is a byte sequence that begins with the most significant byte (MSB) first, and ends with the least significant byte (LSB) last in the sequence: 1|2|3|4. SWAPped order is when the byte sequence begins with the LSB first, and ends with the MSB last in the sequence: 4|3|2|1.

Remote Command:	:FORMat:BORDER NORMal SWAPped :FORMat:BORDER?
Preset:	NORMal
Initial S/W Revision:	Prior to A.02.00

Mode

The Mode key allows you to select the available measurement applications or “Modes”. Modes are a collection of measurement capabilities packaged together to provide an instrument personality that is specific to your measurement needs. Each application software product is ordered separately by Model Number and must be licensed to be available. Once an instrument mode is selected, only the commands that are valid for that mode can be executed.

NOTE Key operation can be different between modes. The information displayed in Help is about the current mode.

To access Help for a different Mode you must first exit Help (by pressing the Cancel (Esc) key). Then select the desired mode and re-access Help.

For more information on Modes, preloading Modes, and memory requirements for Modes, see [“More Information” on page 1535](#)

Key Path:	Front panel key
Remote Command:	:INSTrument [:SElect] SA SEQAN EMI BASIC WCDMA EDGEgSM WIMAXOFDMA VSA PNOISE NFIGURE ADEMOD BT TDSCDMA CDMA2K CDMA1XEV LTE LTETDD DV B DTMB DCATV ISDBT CMMB CWLAN CWIMAXOFDM WIMAXFIXED IDE N RLC SCPILC VSA89601 :INSTrument [:SElect]?
Example:	:INST SA

Notes:	The available parameters are dependent upon installed and licensed applications resident in the instrument. Parameters given here are an example, specific parameters are in the individual Application. A list of the valid mode choices is returned with the INST:CAT? Query.
Preset:	Not affected by Preset. Set to SA following Restore System Defaults, if SA is the default mode.
State Saved:	Saved in instrument state
Backwards Compatibility SCPI:	:INSTrument[:SElect] GSM provided for backwards compatibility. Mapped to EDGE GSM.
Backwards Compatibility SCPI:	:INSTrument[:SElect] SANalyzer provided for ESU compatibility. When this command is received, the analyzer aliases it to the following: INST:SEL SCILC This results in the analyzer being placed in SCPI Language Compatibility Mode, in order to emulate the ESU Spectrum Analyzer Mode.
Backwards Compatibility SCPI:	:INSTrument[:SElect] REceiver provided for ESU compatibility. When this command is received, the analyzer aliases it to the following: :INST:SEL EMI :CONF FSC This results in the analyzer being placed in the EMI Receiver Mode, running the Frequency Scan measurement, in order to emulate the ESU Receiver Mode.
Initial S/W Revision:	Prior to A.02.00
Modified at S/W Revision:	A.10.01

Example:	:INST 'SA'
Notes:	The query is not a quoted string. It is an enumeration as indicated in the Instrument Select table above. The command must be sequential: i.e. continued parsing of commands cannot proceed until the instrument select is complete and the resultant SCPI trees are available.
Backwards Compatibility SCPI:	:INSTrument[:SElect] 'SA' 'PNOISE' 'EDGE' 'GSM' 'BASIC'
Initial S/W Revision:	Prior to A.02.00

More Information

The Mode name appears on the banner after the word “Agilent” followed by the Measurement Title. For example, for the Spectrum Analyzer mode with the Swept SA measurement running:

It is possible to specify the order in which the Modes appear in the Mode menu, using the Configure Applications utility (**System, Power On, Configure Applications**). It is also possible, using the same utility, to specify a subset of the available applications to load into memory at startup time, which can significantly decrease the startup time of the analyzer. During runtime, if an application that is not loaded into memory is selected (by either pressing that applications Mode key or sending that applications :INST:SEL command over SCPI), there will be a pause while the Application is loaded. During this pause a message box that says “Loading application, please wait...” is displayed.

Each application (Mode) that runs in the X-Series signal analyzers consumes virtual memory. The various applications consume varying amounts of virtual memory, and as more applications run, the memory consumption increases. Once an application is run, some of its memory remains allocated even when it is not running, and is not released until the analyzer program (xSA.exe) is shut down.

Agilent characterizes each Mode and assigns a memory usage quantity based on a conservative estimate. There is a limited amount of virtual memory available to applications (note that this is virtual memory and is independent of how much physical RAM is in the instrument). The instrument keeps track of how much memory is being used by all loaded applications – which includes those that preloaded at startup, and all of those that have been run since startup.

When you request a Mode that is not currently loaded, the instrument looks up the memory estimate for that Mode, and adds it to the residual total for all currently loaded Modes. If there is not enough virtual memory to load the Mode, a dialog box and menu will appear that gives you four options:

Close and restart the analyzer program without changing your configured preloads. This may free up enough memory to load the requested Mode, depending on your configured preloads

Clear out all preloads and close and restart the analyzer program with only the requested application preloaded, and with that application running. This choice is guaranteed to allow you to run the requested application; but you will lose your previously configured preloads. In addition, there may be little or no room for other applications, depending on the size of the requested application.

Bring up the Configure Applications utility in order to reconfigure the preloaded apps to make room for the applications you want to run (this will then require restarting the analyzer program with your new configuration). This is the recommended choice because it gives you full flexibility to select exactly what you want.

Exit the dialog box without doing anything, which means you will be unable to load the application you requested.

In each case except 4, this will cause the analyzer software to close, and you will lose all unsaved traces and results.

If you attempt to load a mode via SCPI that will exceed memory capacity, the Mode does not load and an error message is returned:

```
-225, "Out of memory;Insufficient resources to load Mode (mode name)"
```

where “mode name” is the SCPI parameter for the Mode in question, for example, SA for Spectrum Analyzer Mode.

Application Mode Number Selection (Remote Command Only)

Select the measurement mode by its mode number. The actual available choices depend upon which applications are installed in your instrument. The modes appear in this table in the same order they appear in the Mode menu (if the order is not changed by the Configure Applications utility found in the **System, Power On** menu). See [“Detailed List of Modes” on page 1542](#) for Mode details.

The Mode Number is the parameter for use with the :INSTrument:NSElect command. The Mode Parameter is the parameter for use with the :INSTrument[:SElect] command.

Mode	Mode Number	Mode Parameter
Spectrum Analyzer	1	SA
Sequence Analyzer	400	SEQAN
EMI Receiver	141	EMI
I/Q Analyzer (Basic)	8	BASIC
WCDMA with HSPA+	9	WCDMA
GSM/EDGE/EDGE Evo	13	EDGE GSM
802.16 OFDMA (WiMAX/WiBro)	75	WIMAX OFDMA
Vector Signal Analyzer (VXA)	100	VSA
Phase Noise	14	PNOISE
Noise Figure	219	NFIGURE
Analog Demod	234	ADEMODO
Bluetooth	228	BT
TD-SCDMA with HSPA/8PSK	211	TDSCDMA
cdma2000	10	CDMA2K
1xEV-DO	15	CDMA1XEV
LTE	102	LTE
LTE TDD	105	LTETDD
MSR	106	MSR
DVB-T/H with T2	235	DVB
DTMB (CTTB)	236	DTMB
Digital Cable TV	238	DCATV
ISDB-T	239	ISDBT
CMMB	240	CMMB
WLAN	217	WLAN

Common Measurement Functions 1

Mode	Mode Number	Mode Parameter
Combined WLAN	19	CWLAN
Combined Fixed WiMAX	81	CWIMAXOFDM
802.16 OFDM (Fixed WiMAX)	104	WIMAXFIXED
iDEN/WiDEN/MotoTalk	103	IDEN
Remote Language Compatibility	266	RLC
SCPI Language Compatibility	270	SCPILC
89601 VSA	101	VSA89601

Remote Command:	:INSTRument:NSElect <integer> :INSTRument:NSElect?
Example:	:INST:NSEL 1
Notes:	SA mode is 1 The command must be sequential: i.e. continued parsing of commands cannot proceed until the instrument select is complete and the resultant SCPI trees are available.
Preset:	Not affected by Preset. Set to default mode (1 for SA mode) following Restore System Defaults.
State Saved:	Saved in instrument state
Initial S/W Revision:	Prior to A.02.00

Application Mode Catalog Query (Remote Command Only)

Returns a string containing a comma separated list of names of all the installed and licensed measurement modes (applications). These names can only be used with the :INSTRument[:SElect] command.

Remote Command:	:INSTRument:CATalog?
Example:	:INST:CAT?
Notes:	Query returns a quoted string of the installed and licensed modes separated with a comma. Example: "SA,PNOISE,WCDMA"

Backwards Compatibility Notes:	VSA (E4406A) :INSTRument:CATalog? returned a list of installed INSTRument:SELECT items as a comma separated list of string values: "BASIC","GSM","EDGEgSM","CDMA","NADC","PDC","WCDMA","CDMA2K","CDMA1XEV","IDEN","WIDEN","WLAN","SERVICE" X-Series uses the ESA/PSA compatible query of a string contain comma separated values: "SA,PNOISE,NFIGURE,BASIC,CDMA,CDMA2K,WCDMA,CDMA1XEV,EDGEgSM,GSM,NADC,PDC,TDSCDMA,DMODULATION,WLAN"
Initial S/W Revision:	Prior to A.02.00

Application Identification (Remote Commands Only)

Each entry in the Mode Menu will have a Model Number and associated information: Version, and Options.

This information is displayed in the Show System screen. The corresponding SCPI remote commands are defined here.

Current Application Model

Returns a string that is the Model Number of the currently selected application (mode).

Remote Command:	:SYSTem:APPLication[:CURRent][:NAME]?
Example:	:SYST:APPL?
Notes:	Query returns a quoted string that is the Model Number of the currently selected application (Mode). Example: "N9060A" String length is 6 characters.
Preset:	Not affected by Preset
State Saved:	Not saved in state, the value will be the selected application when a Save is done.
Initial S/W Revision:	Prior to A.02.00

Current Application Revision

Returns a string that is the Revision of the currently selected application (mode).

Remote Command:	:SYSTem:APPLication[:CURRent]:REVersion?
Example:	:SYST:APPL:REV?

Common Measurement Functions 1

Notes:	Query returns a quoted string that is the Revision of the currently selected application (Mode). Example: "1.0.0.0" String length is a maximum of 23 characters. (each numeral can be an integer + 3 decimal points)
Preset:	Not affected by a Preset
State Saved:	Not saved in state, the value will be the selected application when a Save is done.
Initial S/W Revision:	Prior to A.02.00

Current Application Options

Returns a string that is the Options list of the currently selected application (Mode).

Remote Command:	:SYSTem:APPLication[:CURRent]:OPTion?
Example:	:SYST:APPL:OPT?
Notes:	Query returns a quoted string that is the Option list of the currently selected application (Mode). The format is the name as the *OPT? or SYSTem:OPTion command: a comma separated list of option identifiers. Example: "1FP,2FP" String length is a maximum of 255 characters.
Preset:	Not affected by a Preset
State Saved:	Not saved in state per se, the value will be the selected application when a Save is invoked.
Initial S/W Revision:	Prior to A.02.00

Application Identification Catalog (Remote Commands Only)

A catalog of the installed and licensed applications (Modes) can be queried for their identification.

Application Catalog number of entries

Returns the number of installed and licensed applications (Modes).

Remote Command:	:SYSTem:APPLication:CATalog[:NAME]:COUNT?
Example:	:SYST:APPL:CAT:COUN?
Preset:	Not affected by Preset
State Saved:	Not saved in instrument state.
Initial S/W Revision:	Prior to A.02.00

Application Catalog Model Numbers

Returns a list of Model Numbers for the installed and licensed applications (Modes).

Remote Command:	:SYSTem:APPLication:CATalog[:NAME]?
Example:	:SYST:APPL:CAT?
Notes:	Returned value is a quoted string of a comma separated list of Model Numbers. Example, if SAMS and Phase Noise are installed and licensed: "N9060A,N9068A" String length is COUNT * 7 - 1. (7 = Model Number length + 1 for comma. -1 = no comma for the 1st entry.)
Preset:	Not affected by a Preset
State Saved:	Not saved in instrument state.
Initial S/W Revision:	Prior to A.02.00

Application Catalog Revision

Returns the Revision of the provided Model Number.

Remote Command:	:SYSTem:APPLication:CATalog:REVision? <model>
Example:	:SYST:APPL:CAT:REV? 'N9060A'
Notes:	Returned value is a quoted string of revision for the provided Model Number. The revision will be a null-string ("") if the provided Model Number is not installed and licensed. Example, if SAMS is installed and licensed: "1.0.0.0"
Preset:	Not affected by a Preset.
State Saved:	Not saved in instrument state.
Initial S/W Revision:	Prior to A.02.00

Application Catalog Options

Returns a list of Options for the provided Model Number

Remote Command:	:SYSTem:APPLication:CATalog:OPTion? <model>
Example:	:SYST:APPL:CAT:OPT? 'N9060A'
Notes:	Returned value is a quoted string of a comma separated list of Options, in the same format as *OPT? or :SYSTem:OPTion?. If the provided Model Number is not installed and licensed a null-string ("") will be returned. Example, if SAMS is installed and licensed: "2FP" String length is a maximum of 255 characters.

Common Measurement Functions 1

Preset:	Not affected by a Preset
State Saved:	Not saved in instrument state.
Initial S/W Revision:	Prior to A.02.00

Detailed List of Modes

1xEV-DO

Selects the 1xEV-DO mode for general purpose measurements of signals following this standard. There are several measurements available in this mode.

If you are using the Help feature, this mode must be currently active to access its detailed information. If it is not active, exit the Help feature (Esc key), select the mode, and re-access Help.

Key Path:	Mode
Example:	INST:SEL CDMA1XEV INST:NSEL 15
Initial S/W Revision:	Prior to A.02.00

802.16 OFDMA (WiMAX/WiBro)

Selects the OFDMA mode for general purpose measurements of WiMAX signals. There are several measurements available in this mode.

If you are using the Help feature, this mode must be currently active to access its detailed information. If it is not active, exit the Help feature (Esc key), select the mode, and re-access Help.

Key Path:	Mode
Example:	INST:SEL WIMAXOFDMA INST:NSEL 75
Initial S/W Revision:	Prior to A.02.00

802.16 OFDM (Fixed WiMAX)

Selects the 802.16 OFDM (Fixed WiMAX) mode. This mode allows modulation quality measurements of signals that comply with IEEE 802.16a–2003 and IEEE 802.16–2004 standards, with flexibility to measure nonstandard OFDM formats. Along with the typical digital demodulation measurement results, several additional 802.16 OFDM unique trace data formats and numeric error data results provide enhanced data analysis.

If you are using the Help feature, this mode must be currently active to access its detailed information. If it is not active, exit the Help feature (Esc key), select the mode, and re-access Help.

Key Path:	Mode
Example:	INST:SEL WIMAXFIXED INST:NSEL 104

Initial S/W Revision:	A.02.00
-----------------------	---------

89601 VSA

Selecting the 89601 VSA mode will start the 89600-Series VSA software application. The 89600 VSA software is powerful, PC-based software, offering the industry's most sophisticated general purpose and standards specific signal evaluation and troubleshooting tools for the R&D engineer. Reach deeper into signals, gather more data on signal problems, and gain greater insight.

- Over 30 general-purpose analog and digital demodulators ranging from 2FSK to 1024QAM
- Standards specific modulation analysis including:
 - Cell: GSM, cdma2000, WCDMA, TD-SCDMA and more
 - Wireless networking: 802.11a/b/g, 802.11n, 802.16 WiMAX (fixed/mobile), UWB
 - RFID
 - Digital satellite video and other satellite signals, radar, LMDS
- Up to 400K bin FFT, for the highest resolution spectrum analysis
- A full suite of time domain analysis tools, including signal capture and playback, time gating, and CCDF measurements
- Six simultaneous trace displays and the industry's most complete set of marker functions
- Easy-to-use Microsoft ® Windows ® graphical user interface

For more information see the Agilent 89600 Series VSA web site at www.agilent.com/find/89600

To learn more about how to use the 89600 VSA running in the X-Series, after the 89600 VSA application is running, open the 89600 VSA Help and open the "About Agilent X-Series Signal Analyzers (MXA/EXA) with 89600-Series Software" help topic.

Key Path:	Mode
Example:	INST:SEL VSA89601 INST:NSEL 101
Initial S/W Revision:	Prior to A.02.00

Analog Demod

Selects the Analog Demod mode for making measurements of AM, FM and phase modulated signals.

If you are using the Help feature, this mode must be currently active to access its detailed information. If it is not active, exit the Help feature (Esc key), select the mode, and re-access Help.

Key Path:	Mode
Example:	INST:SEL ADEMOM INST:NSEL 234
Initial S/W Revision:	Prior to A.02.00

Common Measurement Functions 1

Bluetooth

Selects the Bluetooth mode for Bluetooth specific measurements. There are several measurements available in this mode.

If you are using the Help feature, this mode must be currently active to access its detailed information. If it is not active, exit the Help feature (Esc key), select the mode, and re-access Help.

Key Path:	Mode
Example:	INST:SEL BT INST:NSEL 228
Initial S/W Revision:	A.06.01

cdma2000

Selects the cdma2000 mode for general purpose measurements of signals following this standard. There are several measurements available in this mode.

If you are using the Help feature, this mode must be currently active to access its detailed information. If it is not active, exit the Help feature (Esc key), select the mode, and re-access Help.

Key Path:	Mode
Example:	INST:SEL CDMA2K INST:NSEL 10
Initial S/W Revision:	Prior to A.02.00

CMMB

Selects the CMMB mode for measurements of digital video signals using this format. There are several power and demod measurements available in this mode.

If you are using the Help feature, this mode must be currently active to access its detailed information. If it is not active, exit the Help feature (Esc key), select the mode, and re-access Help.

Key Path:	Mode
Example:	INST:SEL CMMB INST:NSEL 240
Initial S/W Revision:	A.03.00

Combined WLAN

Selects the CWLAN mode for general purpose measurements of signals following this standard. There are several measurements available in this mode.

If you are using the Help feature, this mode must be currently active to access its detailed information. If

it is not active, exit the Help feature (Esc key), select the mode, and re-access Help.

Key Path:	Mode
Example:	INST:SEL CWLAN INST:NSEL 19
Initial S/W Revision:	A.02.00

Combined Fixed WiMAX

Selects the Combined Fixed WiMAX mode for general purpose measurements of signals following this standard. There are several measurements available in this mode.

If you are using the Help feature, this mode must be currently active to access its detailed information. If it is not active, exit the Help feature (Esc key), select the mode, and re-access Help.

Key Path:	Mode
Example:	INST:SEL CWIMAXOFDM INST:NSEL 81
Initial S/W Revision:	A.02.00

Digital Cable TV

Selects the Digital Cable TV mode for measurements of digital cable television systems. There are several power and demod measurements available in this mode.

If you are using the Help feature, this mode must be currently active to access its detailed information. If it is not active, exit the Help feature (Esc key), select the mode, and re-access Help.

Key Path:	Mode
Example:	INST:SEL DCATV INST:NSEL 238
Initial S/W Revision:	A.07.00

DTMB (CTTB)

Selects the DTMB (CTTB) mode for measurements of digital video signals using this format. There are several power and demod measurements available in this mode.

If you are using the Help feature, this mode must be currently active to access its detailed information. If it is not active, exit the Help feature (Esc key), select the mode, and re-access Help.

Key Path:	Mode
Example:	INST:SEL DTMB INST:NSEL 236

Common Measurement Functions 1

Initial S/W Revision:	A.02.00
-----------------------	---------

DVB-T/H with T2

Selects the DVB-T/H mode for measurements of digital video signals using this format. There are several power and demod measurements available in this mode.

If you are using the Help feature, this mode must be currently active to access its detailed information. If it is not active, exit the Help feature (Esc key), select the mode, and re-access Help.

Key Path:	Mode
Example:	INST:SEL DVB INST:NSEL 235
Initial S/W Revision:	A.02.00
Modified at S/W Revision:	A.07.00

EMI Receiver

The EMI Receiver Mode makes EMC measurements. Several measurements are provided to aid the user in characterizing EMC performance of their systems, including looking at signals with CISPR-16 compliant detectors, performing scans for interfering signals, and determining and charting interfering signals over time.

If you are using the Help feature, this mode must be currently active to access its detailed information. If it is not active, exit the Help feature (Esc key), select the mode, and re-access Help.

Key Path:	Mode
Example:	INST:SEL EMI INST:NSEL 141
Initial S/W Revision:	A.07.01

GSM/EDGE/EDGE Evo

Selects the GSM with EDGE mode for general purpose measurements of signals following this standard. There are several measurements available in this mode.

If you are using the Help feature, this mode must be currently active to access its detailed information. If it is not active, exit the Help feature (Esc key), select the mode, and re-access Help.

Key Path:	Mode
Example:	INST:SEL EDGEGSM INST:NSEL 13
Initial S/W Revision:	Prior to A.02.00
Modified at S/W Revision:	A.02.00

iDEN/WiDEN/MOTOTalk

Selects the iDEN/WiDEN/MOTOTalk mode for general purpose measurements of iDEN and iDEN-related signals. There are several measurements available in this mode.

If you are using the Help feature, this mode must be currently active to access its detailed information. If it is not active, exit the Help feature (Esc key), select the mode, and re-access Help.

Key Path:	Mode
Example:	INST:SEL IDEN INST:NSEL 103
Initial S/W Revision:	A.02.00

IQ Analyzer (Basic)

The IQ Analyzer Mode makes general purpose frequency domain and time domain measurements. These measurements often use alternate hardware signal paths when compared with a similar measurement in the Signal Analysis Mode using the Swept SA measurement. These frequency domain and time domain measurements can be used to output I/Q data results when measuring complex modulated digital signals.

If you are using the Help feature, this mode must be currently active to access its detailed information. If it is not active, exit the Help feature (Esc key), select the mode, and re-access Help.

Key Path:	Mode
Example:	INST:SEL BASIC INST:NSEL 8
Initial S/W Revision:	Prior to A.02.00

ISDB-T

Selects the ISDB-T mode for measurements of digital video signals using this format. There are several power and demod measurements available in this mode.

If you are using the Help feature, this mode must be currently active to access its detailed information. If it is not active, exit the Help feature (Esc key), select the mode, and re-access Help.

Key Path:	Mode
Example:	INST:SEL ISDBT INST:NSEL 239
Initial S/W Revision:	A.03.00

LTE

Selects the LTE mode for general purpose measurements of signals following the LTE FDD standard. There are several measurements available in this mode.

If you are using the Help feature, this mode must be currently active to access its detailed information. If

Common Measurement Functions 1

it is not active, exit the Help feature (Esc key), select the mode, and re-access Help.

Key Path:	Mode
Example:	INST:SEL LTE INST:NSEL 102
Initial S/W Revision:	Prior to A.02.00

LTE TDD

Selects the LTE TDD mode for general purpose measurements of signals following the LTE TDD standard. There are several measurements available in this mode.

If you are using the Help feature, this mode must be currently active to access its detailed information. If it is not active, exit the Help feature (Esc key), select the mode, and re-access Help.

Key Path:	Mode
Example:	INST:SEL LTETDD INST:NSEL 105
Initial S/W Revision:	A.03.00

MSR

Selects the MSR mode. The MSR mode makes several measurements for Cellular Communication devices that can be configured with multiple radio formats simultaneously following the 3GPP standard of Multi-Standard Radio, including GSM/EDGE, WCDMA/HSPA+ and LTE.

If you are using the Help feature, this mode must be currently active to access its detailed information. If it is not active, exit the Help feature (Esc key), select the mode, and re-access Help.

Key Path:	Mode
Example:	INST:SEL MSR INST:NSEL 106
Initial S/W Revision:	A.10.01

Noise Figure

The Noise Figure mode provides pre-configured measurements for making general purpose measurements of device noise figure.

If you are using the Help feature, this mode must be currently active to access its detailed information. If it is not active, exit the Help feature (Esc key), select the mode, and re-access Help.

Key Path:	Mode
Example:	INST:SEL NFIGURE INST:NSEL 219

Initial S/W Revision:	Prior to A.02.00
-----------------------	------------------

Phase Noise

The Phase Noise mode provides pre-configured measurements for making general purpose measurements of device phase noise.

If you are using the Help feature, this mode must be currently active to access its detailed information. If it is not active, exit the Help feature (Esc key), select the mode, and re-access Help.

Key Path:	Mode
Example:	INST:SEL PNOISE or INST:NSEL 14
Initial S/W Revision:	Prior to A.02.00

Remote Language Compatibility

The Remote Language Compatibility (RLC) mode provides remote command backwards compatibility for the 8560 series of spectrum analyzers, known as legacy spectrum analyzers.

NOTE After changing into or out of this mode, allow a 1 second delay before sending any subsequent commands.

If you are using the Help feature, this mode must be currently active to access its detailed information. If it is not active, exit the Help feature (Esc key), select the mode, and re-access Help.

Key Path:	Mode
Example:	INST:SEL RLC Or INST:NSEL 266
Initial S/W Revision:	Prior to A.02.00

SCPI Language Compatibility

The SCPI Language Compatibility mode provides remote language compatibility for SCPI-based instruments, such as the Rohde and Schwartz FSP and related series of spectrum analyzers.

NOTE After changing into or out of this mode, allow a 1 second delay before sending any subsequent commands.

If you are using the Help feature, this mode must be currently active to access its detailed information. If

Common Measurement Functions 1

it is not active, exit the Help feature (Esc key), select the mode, and re-access Help.

Key Path:	Mode
Example:	INST:SEL SCPILC Or INST:NSEL 270
Initial S/W Revision:	A.06.00

Spectrum Analyzer

Selects the Spectrum Analyzer mode for general purpose measurements. There are several measurements available in this mode. General spectrum analysis measurements, in swept and zero span, can be done using the first key in the Meas menu, labeled Swept SA. Other measurements in the Meas Menu are designed to perform specialized measurement tasks, including power and demod measurements.

If you are using the Help feature, this mode must be currently active to access its detailed information. If it is not active, exit the Help feature (Esc key), select the mode, and re-access Help.

Key Path:	Mode
Example:	INST:SEL SA INST:NSEL 1
Initial S/W Revision:	Prior to A.02.00

TD-SCDMA with HSPA/8PSK

Selects the TD-SCDMA mode for general purpose measurements of signals following this standard. There are several measurements available in this mode.

If you are using the Help feature, this mode must be currently active to access its detailed information. If it is not active, exit the Help feature (Esc key), select the mode, and re-access Help.

Key Path:	Mode
Example:	INST:SEL TDSCDMA INST:NSEL 211
Initial S/W Revision:	Prior to A.02.00

Vector Signal Analyzer (VXA)

The N9064A (formerly 89601X) VXA Vector signal and WLAN modulation analysis application provides solutions for basic vector signal analysis, analog demodulation, digital demodulation and WLAN analysis. The digital demodulation portion of N9064A allows you to perform measurements on standard-based formats such as cellular, wireless networking and digital video as well as general purpose flexible modulation analysis for wide range of digital formats, FSK to 1024QAM, with easy-to-use measurements and display tools such as constellation and eye diagram, EVM traces and up to four simultaneous displays. The WLAN portion of N9064A allows you to make RF transmitter

measurements on 802.11a/b/g/p/j WLAN devices. Analog baseband analysis is available using the MXA with option BBA.

N9064A honors existing 89601X licenses with all features and functionalities found on X-Series software versions prior to A.06.00.

If you are using the Help feature, this mode must be currently active to access its detailed information. If it is not active, exit the Help feature (Esc key), select the mode, and re-access Help.

Key Path:	Mode
Example:	INST:SEL VSA INST:NSEL 100
Initial S/W Revision:	Prior to A.02.00

W-CDMA with HSPA+

Selects the W-CDMA with HSPA+ mode for general purpose measurements of signals following this standard. There are several measurements available in this mode.

If you are using the Help feature, this mode must be currently active to access its detailed information. If it is not active, exit the Help feature (Esc key), select the mode, and re-access Help.

Key Path:	Mode
Example:	INST:SEL WCDMA INST:NSEL 9
Initial S/W Revision:	Prior to A.02.00

WLAN

Selects the WLAN mode for general purpose measurements of signals following this standard. There are several measurements available in this mode.

If you are using the Help feature, this mode must be currently active to access its detailed information. If it is not active, exit the Help feature (Esc key), select the mode, and re-access Help.

Key Path:	Mode
Example:	INST:SEL WLAN INST:NSEL 217
Initial S/W Revision:	A.10.01

Global Settings

Opens up a menu that allows you to switch certain Meas Global parameters to a Mode Global state. These switches apply to all Modes that support global settings. No matter what Mode you are in when

Common Measurement Functions 1

you set the “Global Center Frequency” switch to on, it applies to all Modes that support Global Settings.

Key Path:	Front Panel Key
Initial S/W Revision:	Prior to A.02.00

Global Center Freq

The software maintains a Mode Global value called “Global Center Freq”.

When the **Global Center Freq** key is switched to **On** in any mode, the current mode’s center frequency is copied into the Global Center Frequency, and from then on all modes which support global settings use the Global Center Frequency. So you can switch between any of these modes and the Center Freq will remain unchanged.

Adjusting the Center Freq of any mode which supports Global Settings, while **Global Center Freq** is **On**, will modify the Global Center Frequency.

When **Global Center Freq** is turned **Off**, the Center Freq of the current mode is unchanged, but now the Center Freq of each mode is once again independent.

When **Mode Preset** is pressed while **Global Center Freq** is **On**, the Global Center Freq is preset to the preset Center Freq of the current mode.

This function is reset to Off when the Restore Defaults key is pressed in the Global Settings menu, or when **System, Restore Defaults, All Modes** is pressed.

Key Path:	Mode Setup, Global Settings
Scope:	Mode Global
Remote Command:	:INSTrument:COUPle:FREQuency:CENTer ALL NONE :INSTrument:COUPle:FREQuency:CENTer?
Example:	INST:COUP:FREQ:CENT ALL INST:COUP:FREQ:CENT?
Preset:	Set to Off on Global Settings, Restore Defaults and System, Restore Defaults, All Modes
Range:	On Off
Initial S/W Revision:	Prior to A.02.00

Remote Command:	:GLOBal:FREQuency:CENTer[:STATe] 1 0 ON OFF :GLOBal:FREQuency:CENTer[:STATe]?
Preset:	Off
Initial S/W Revision:	Prior to A.02.00

Restore Defaults

This key resets all of the functions in the Global Settings menu to Off. This also occurs when **System,**

Restore Defaults, All Modes is pressed.

Key Path:	Mode Setup, Global Settings
Remote Command:	:INSTrument:COUPle:DEFault
Example:	INST:COUP:DEF
Backwards Compatibility SCPI:	:GLOBal:DEFault
Initial S/W Revision:	Prior to A.02.00

Mode Setup

Accesses a menu that enables you to select mode parameters. These settings are in effect for all measurements in the current mode.

Key Path	Front Panel
Initial S/W Revision	Prior to A.02.00

Direction

Enables you to set the Direction of the signal being measured. The Sync/Format, Chan Profile, Time and Advanced menus will all change based on the link direction selected. Also, since downlink and uplink signals use OFDMA and SC-FDMA respectively, the list of trace results available and the default traces presented will also change based on the link direction parameter.

Key Path	Mode Setup
Mode	VSA
Remote Command	[:SENSe]:RADio:STANdard:DIRection DLINk ULINk [:SENSe]:RADio:STANdard:DIRection?
Example	RAD:STAN:DIR DLIN
Couplings	Changes in Direction affect many other modulation analysis setup parameters
Preset	DLIN
State Saved	Saved in instrument state.
Range	Downlink Uplink
Initial S/W Revision	Prior to A.02.00

Demod

Accesses a menu that enables you to select parameters used in demodulation measurements.

Key Path	Mode setup
Initial S/W Revision	Prior to A.02.00

Common Measurement Functions 1

Bandwidth

Enables you to set the LTE signal bandwidth (which also determines the total number of resource blocks for Modulation Analysis measurement).

Key Path	Mode Setup, Demod
Mode	LTE
Remote Command	[:SENSE] :RADio:STANdard:BANDwidth B1M4 B3M B5M B10M B15M B20M [:SENSE] :RADio:STANdard:BANDwidth?
Example	RAD:STAN:BAND B5M
Preset	B5M
State Saved	Saved in instrument state.
Range	1.4 MHz (6 RB) 3 MHz (15 RB) 5 MHz (25 RB) 10 MHz (50 RB) 15 MHz (75 RB) 20 MHz (100 RB)
Initial S/W Revision	Prior to A.02.00
Modified at S/W Revision	A.03.00

Spectrum

Determines if the spectrum of the incoming data is mirrored or not. The actual mirroring is accomplished by conjugating the complex time data.

Note that only the Modulation Analysis measurement and Conformance EVM measurement support this feature.

Key Path	Mode Setup, Demod
Mode	LTE
Remote Command	[:SENSE] :SPECtrum NORMal INVert [:SENSE] :SPECtrum?
Example	SPEC INV SPEC?
Preset	NORM
State Saved	Saved in instrument state.
Range	Normal Invert
Initial S/W Revision	Prior to A.02.00
Modified at S/W Revision	A.03.00

Fixed Equalization

Enables you to apply a fixed FIR equalization filter to the time data, before it is used in further analysis.

You define the filter by its frequency response rather than by its impulse response. The frequency response must be stored in a data register.

Note that only the Modulation Analysis measurement supports this feature.

Key Path	Mode Setup, Demod
Mode	LTE
Initial S/W Revision	Prior to A.02.00

Fixed EQ Mode

Enables you to turn fixed equalization off, on in normal mode, or on in inverted mode. The effect of Normal mode is to divide the spectrum of the unequalized data by the frequency response in the data register. Invert mode multiplies instead of divides.

Key Path	Mode Setup, Demod, Fixed Equalization
Mode	LTE
Remote Command	[:SENSE]:CORRection:FEQualizer OFF NORMal INVert [:SENSE]:CORRection:FEQualizer?
Example	CORR:FEQ NORM CORR:FEQ?
Preset	OFF
State Saved	Saved in instrument state.
Range	Off Normal Invert
Initial S/W Revision	Prior to A.02.00
Modified at S/W Revision	A.03.00

Freq Response Register

Enables you to choose a register that contains the frequency response information for fixed equalization.

Key Path	Mode Setup, Demod, Fixed Equalization
Mode	LTE
Remote Command	[:SENSE]:CORRection:FEQualizer:REGister D1 D2 D3 D4 D5 D6 [:SENSE]:CORRection:FEQualizer:REGister?
Example	CORR:FEQ:REG D2 CORR:FEQ:REG?
Preset	D1
State Saved	Saved in instrument state.

Common Measurement Functions 1

Range	Data 1 Data 2 Data 3 Data 4 Data 5 Data 6
Initial S/W Revision	Prior to A.02.00
Modified at S/W Revision	A.03.00

Preset to Standard

Sets the parameters to the LTE standard preset.

Key Path	Mode Setup
Mode	LTE
Remote Command	[:SENSE] :RADio:STANdard:PRESet B1M4 B3M B5M B10M B15M B20M
Example	RAD:STAN:PRES B5M
Couplings	Preset To Standard presets parameter values
Preset	B5M
State Saved	Saved in instrument state.
Range	1.4 MHz (6 RB) 3 MHz (15 RB) 5 MHz (25 RB) 10 MHz (50 RB) 15 MHz (75 RB) 20 MHz (100 RB)
Initial S/W Revision	Prior to A.02.00
Modified at S/W Revision	A.03.00

Noise Reduction

Noise Reduction accesses a menu for configuring the noise compensation of the instrument. This menu only appears in models that support Noise Reduction.

Key Path	Mode Setup
Initial S/W Revision	A.04.00

Noise Floor Extension

Turns on the **Noise Floor Extension** function. When this function is On, the expected noise power of the analyzer (derived from a factory calibration) is subtracted from the trace data. When **Noise Floor Extension** is On, it will usually reduce the apparent noise level by about 10 dB in low band, and 8 dB in high band (>~3.6 GHz).

Noise Floor Extension works with any RBW, VBW, detector, any setting of Average Type, any amount of trace averaging, and any signal type. It is ineffective when the trace is not smoothed (smoothing processes include narrow VBWs, trace averaging, and long sweep times with the detector set to Average or Peak). It works best with extreme amounts of smoothing. It works best with the average detector, with the Average Type set to Power.

In those cases where the cancellation is ineffective, it nonetheless has no undesirable side-effects. There is no significant speed impact to having **Noise Floor Extension** on.

The best accuracy is achieved when substantial smoothing occurs in each point before trace averaging. Thus, when using the average detector, results are better with long sweep times and fewer trace averages. When using the sample detector, the VBW filter should be set narrow with less trace averaging, instead of a wide VBW filter with more trace averaging.

See “[More Information](#)” on page 1557.

Key Path	Mode Setup, Noise Reduction
Scope	Meas Global
Remote Command	[:SENSe]:CORRection:NOISe:FLOOr ON OFF 1 0 [:SENSe]:CORRection:NOISe:FLOOr?
Example	CORR:NOIS:FLO ON
Dependencies	In models that do not support Noise Floor Extension, the SCPI command will be accepted without error but will have no effect.
Preset	Unaffected by Mode Preset. Turned off by Restore Mode Defaults.
State Saved	No
Initial S/W Revision	A.04.00

More Information

The analyzer is characterized in the factory (or during a field calibration) with a model of the noise, referred to the input mixer, versus frequency in each band and path combination. Bands are 0 (low band) and 1 through 4 (high band) in a 26.5 GHz instrument, for example. Paths include normal paths, preamp paths, the electronic attenuator, etc.

In most band/path combinations, the noise can be well characterized based on just two parameters and the analyzer frequency response before compensation for frequency-dependent losses.

After the noise density at the input mixer is estimated, the effects of the input attenuator, RBW, detector, etc. are computed to get the estimated input-port-referred noise level.

In the simplest case, the measured power (signal plus analyzer noise) in each display point (bucket) is compensated by subtracting the estimated noise power, leaving just the signal power. This is the operation when the detector is Average and the Average Type is set to Power.

In other cases, operation is often not quite as good but still highly effective. With peak detection, the noise floor is estimated based on the RBW and the duration of the bucket using the same equations used in the noise marker function. The voltage of the noise is subtracted from the voltage of the observed signal-plus-noise measurement to compute the estimated signal voltage. The peak detector is one example of processing that varies with detector to give good estimates of the signal level without the analyzer noise.

For best operation, the average detector and the power scale are recommended, as already stated. Peak detection for pulsed-RF can still give excellent effectiveness. FFT analysis does not work well, and does not do NFE well, with pulsed-RF signals, so this combination is not recommended. Negative peak detection is not very useful, either. Sample detection works well, but is never better than the average detector because it doesn't smooth as well. The Normal detector is a combination of peak and negative peak behaviors, and works about as well as these.

Common Measurement Functions 1

For best operation, extreme smoothing is desirable, as already stated. Using narrow VBWs works well, but using very long bucket durations and the average detector works best. Reducing the number of trace points will make the buckets longer.

For best operation, the power scale (Average Type = Power) is optimum. When making CW measurements in the presence of noise without NFE, averaging on the decibel scale has the advantage of reducing the effect of noise. When using NFE, the NFE does an even better job than using the log scale ever could. Using NFE with the log scale is not synergistic, though; NFE with the power scale works a little better than NFE with log averaging type.

Restore Mode Defaults

Resets the state for the currently active mode by resetting the mode persistent settings to their factory default values, clearing mode data, and performing a Mode Preset

For more information, see [“Restore Mode Defaults” on page 188](#).

Key Path	Mode setup
Initial S/W Revision	Prior to A.02.00

Global Settings

See [“Global Settings” on page 1551](#).

Global Center Freq

See [“Global Center Freq” on page 1552](#).

Restore Defaults

See [“Restore Defaults” on page 1552](#).

Restart

The Restart function restarts the current sweep, or measurement, or set of averaged/held sweeps or measurements. If you are Paused, pressing Restart does a Resume.

The Restart function is accessed in several ways:

- Pressing the Restart key
- Sending the remote command INIT:IMMediate
- Sending the remote command INIT:REStart

Key Path:	Front panel key
Remote Command:	:INITiate[:IMMediate] :INITiate:REStart

Example:	:INIT:IMM :INIT:REST
Notes:	:INITiate:REStart and :INITiate:IMMediate perform exactly the same function.
Couplings:	Resets average/hold count k. For the first sweep overwrites all active (update=on) traces with new current data. For application modes, it resets other parameters as required by the measurement.
Status Bits/OPC dependencies:	This is an Overlapped command. The STATus:OPERation register bits 0 through 8 are cleared. The STATus:QUEStionable register bit 9 (INTEgrity sum) is cleared. The SWEEPING bit is set. The MEASURING bit is set.
Backwards Compatibility Notes:	For Spectrum Analysis mode in ESA and PSA, the Restart hardkey and the INITiate:REStart command restart trace averages (displayed average count reset to 1) for a trace in Clear Write , but did not restart Max Hold and Min Hold . In the X-Series, the Restart hardkey and the INITiate:REStart command restart not only Trace Average , but Max Hold and Min Hold traces as well. For wireless comms modes in ESA and PSA, the Restart hardkey and the INITiate:REStart command restart every measurement, which includes all traces and numeric results. There is no change to this operation.
Initial S/W Revision:	Prior to A.02.00

The **Restart** function first aborts the current sweep/measurement as quickly as possible. It then resets the sweep and trigger systems, sets up the measurement and initiates a new data measurement sequence with a new data acquisition (sweep) taken once the trigger condition is met.

If the analyzer is in the process of aligning when **Restart** is executed, the alignment finishes before the restart function is performed.

Even when set for Single operation, multiple sweeps may be taken when Restart is pressed (for example, when averaging/holding is on). Thus when we say that **Restart** "restarts a measurement," we may mean:

- It restarts the current sweep
- It restarts the current measurement
- It restarts the current set of sweeps if any trace is in Trace Average, Max Hold or Min Hold
- It restarts the current set of measurements if Averaging, or Max Hold, or Min Hold is on for the measurement
- depending on the current settings.

With **Average/Hold Number** (in **Meas Setup** menu) set to 1, or Averaging off, or no trace in Trace Average or Hold, a single sweep is equivalent to a single measurement. A single sweep is taken after the trigger condition is met; and the analyzer stops sweeping once that sweep has completed. However, with

Common Measurement Functions 1

Average/Hold Number >1 and at least one trace set to **Trace Average**, **Max Hold**, or **Min Hold (SA Measurement)** or **Averaging on (most other measurements)**, multiple sweeps/data acquisitions are taken for a single measurement. The trigger condition must be met prior to each sweep. The sweep is stopped when the average count k equals the number N set for **Average/Hold Number**. A measurement average usually applies to all traces, marker results, and numeric results; but sometimes it only applies to the numeric results.

Once the full set of sweeps has been taken, the analyzer will go to idle state. To take one more sweep without resetting the average count, increment the average count by 1, by pressing the step up key while Average/Hold Number is the active function, or sending the remote command CALC:AVER:TCON UP.

Save

Most of the functions under this key work the same way in many measurements, so they are documented in the Utility Functions section. For details about this key, see [Save@2600@i](#).

The Amplitude Correction Export Data function under Save is documented here.

Amplitude Correction

Pressing this key selects **Amplitude Corrections** as the data type to be exported. Pressing this key again brings up the Select Menu, which allows the user to select which **Amplitude Correction** to save.

Amplitude Corrections are fully discussed in the documentation of the Input/Output key, under the Corrections softkey.

Key Path:	Front Panel Key
Remote Command:	:MMEMory:STORe:CORRection 1 2 3 4 5 6, <filename>
Example:	:MMEM:STOR:CORR 2 "myAmpcor.csv" saves Correction 2 to the file myAmpcor.csv on the current path. The default path is My Documents\amplitudeCorrections.
Notes:	If the save is initiated via SCPI, and the file already exists, the file will be overwritten. Using the C: drive is strongly discouraged, since it runs the risk of being overwritten during an instrument software upgrade. Both single and double quotes are supported for any filename parameter over SCPI.
Dependencies:	Corrections are not supported by all Measurements. If in a Mode in which some Measurements support it, this key will be grayed out in measurements that do not. The key will not show at all if no measurements in the Mode support it. This key will not appear unless you have the proper option installed in your instrument.
Readback:	Selected Correction

Backwards Compatibility SCPI:	:MMEMory:STORE:CORRection ANTenna CABLe OTHer USER, <filename> For backwards compatibility, ANTenna maps to 1, CABLe maps to 2, OTHer maps to 3 and USER maps to 4
Initial S/W Revision:	A.02.00

Correction Data File

A Corrections Data File contains a copy of one of the analyzer correction tables. Corrections provide a way to adjust the trace display for predetermined gain curves (such as for cable loss).

Corrections files are text files in .csv (comma separated values) form, to make them importable into Excel or other spreadsheet programs. The format for Corrections files is as follows.

Line #	Type of field	Example	Notes
1	File type, must be "Amplitude Correction"	Amplitude Correction	May not be omitted
2	File Description (in quotes)	"Correction Factors for 11966E"	45 characters max; may be empty but may not be omitted. If exceeds 45 characters, error -233 Too much data reported
3	Comment (in quotes)	"Class B Radiated"	45 characters max; may be empty but may not be omitted. If exceeds 45 characters, error -233 Too much data reported
4	Instrument Version, Model #	A.02.06,N9020A	May be empty but may not be omitted
5	Option List, File Format Version	K03 LFE EXM ,01	May be empty but may not be omitted
6	Freq Unit to be used for all frequency values in the file	Frequency Unit,MHz	assumed to be Hz if omitted
7	Antenna Unit	Antenna Unit,None	If omitted leaves the Antenna unit unchanged. The amplitude unit in the Antenna Unit field is a conversion factor that is used to adjust the Y Axis Units of the current mode, if the mode supports Antenna Units. For more details on antenna correction data, refer to the Input/Output, Corrections key description. Allowable values: dBuV/m, dBuA/m, dBG, dBpT, None
8	Freq Interpolation	Frequency Interpolation,Linear	if omitted leaves the Freq Interpolation unchanged. Allowable values: Linear, Logarithmic

Common Measurement Functions 1

9	Bias value in mA	Bias,0.00	If omitted leaves the Bias value unchanged (added as of A.08.50)
10	Bias State	Bias State,On	If omitted leaves the Bias State unchanged. Allowable values: On, Off (added as of A.08.50)
11	Overlap, two values, Freq1 and Freq2, separated by commas.	Overlap,33500,40000	Uses Freq Unit from line 6. Thus, in this example Freq1=33.5 GHz, Freq2=40.0 GHz (see note below). If omitted leaves the overlap unchanged (added as of A.08.50)
12	DATA marker	DATA	Corrections data begins in the next line

Lines 2 through 5 can be empty but must appear in the file. Lines 6 through 11 are optional, the lines can be left out of the file altogether.

The Overlap row and the two Bias rows apply only to external mixing. Both are read-only, they are never written by the analyzer. The only way to insert or modify these rows is to edit the file with a text editor or a spreadsheet editor. These rows are intended for use by mixer manufacturers, as they allow the manufacturer to insert data about how the mixer corrections were generated and how they should be applied. The Bias rows allow you to specify whether to turn Bias on or off when the Correction is turned on and to specify a Bias value (turning off the Correction does not change the Bias, but turning it back on again sets it to the value specified in the file). The Overlap row allows you to specify an overlap region in which two different corrections may be applied. It is expected that in the corrections data itself, there will be TWO corrections values exactly at Max Freq, otherwise Overlap is ignored. The way the overlap is processed is as follows: if at any given time the current analyzer Start Freq is greater than Freq 1 and lower than Freq 2, and the current Stop Freq is greater than Freq 2, extend the first correction point at or above Freq 2 down to Freq 1, rather than using the correction data between Freq1 and Freq2.

The Antenna Unit row can only be used in Correction register 1, because there can only be one setting for Antenna Unit at any given time. If a Correction whose Antenna Unit is set to anything but None is loaded into any Correction register but 1, an error is generated (Mass storage error; Can only load an Antenna Unit into Correction 1). When a correction file is saved from any Correction register but 1, Antenna Unit is always written as None.

Similarly, the Bias rows can only be used in Correction register 1, because there can only be one setting for Bias at any given time. If a Correction file with a Bias or Bias State row is loaded into any Correction register but 1, an error is generated: Mass storage error; Can only load Bias Settings into Correction 1

The data follows the DATA row, as comma separated X, Y pairs; one pair per line.

For example, suppose you have an Antenna to correct for on an N9020A version A.02.06 and the correction data is:

- 0 dB at 200 MHz
- 17 dB at 210 MHz
- 14.8 dB at 225 MHz

Then the file will look like:

- Amplitude Correction

- "Correction Factors for 11966E"
- "Class B Radiated"
- A.02.06,N9020A
- P13 EA3 UK6,01
- Frequency Unit,MHz
- Antenna Unit,dBuV/m
- Frequency Interpolation,Linear
- DATA
- 200.000000,0.00
- 210.000000,17.00
- 225.000000,14.80

The choices for the 1 of N fields in the metadata are as follows:

- Frequency Unit: Hz, kHz, MHz, GHz
- Antenna Unit: dBuv/m, dBuA/m, dBG, dBpT, None
- Frequency Interpolation: Logarithmic, Linear

Amplitude Correction

These keys let you pick which Correction to save. Once selected, the key returns back to the Export Data menu and the selected Correction number is annotated on the key.

The next step in the Save process is to select the Save As key in the Export Data menu.

Key Path:	Save, Data, Amplitude Correction
Preset:	Not part of a Preset, but is reset to Correction 1 by Restore Input/Output Defaults. Survives a shutdown.
Readback:	1
Initial S/W Revision:	A.02.00

Single (Single Measurement/Sweep)

Sets the analyzer for Single measurement operation. The single/continuous state is Meas Global, so the setting will affect all the measurements. If you are Paused, pressing Single does a Resume.

Key Path:	Front panel key
Example:	:INIT:CONT OFF
Notes:	See Cont key description.

Common Measurement Functions 1

Backwards Compatibility Notes:	<p>For Spectrum Analysis mode in ESA and PSA, the Single hardkey and the INITiate:IMM switched from continuous measurement to single measurement and restarted sweeps and averages (displayed average count reset to 1), but did not restart Max Hold and Min Hold. In the X-Series, the Single hardkey and the INITiate:IMM command initiate a sweep/ measurement/ average sequence/hold sequence including Max Hold and Min Hold.</p> <p>For Spectrum Analysis mode in ESA and PSA, the Single hardkey restarted the sweep regardless of whether or not you were in an active sweep or sweep sequence. In the X-Series, Restart does this but Single only restarts the sweep or sweep sequence if you are in the idle state.</p> <p>INIT[:IMM] in ESA & PSA Spectrum Analysis Mode does an implied ABORT. In some other PSA Modes, INIT[:IMM] is ignored if not in the idle state. The X-Series follows the ESA/PSA SA Mode model, which may cause some Modes to have compatibility problems.</p>
Initial S/W Revision:	Prior to A.02.00

Source

This mode does not have any Source control functionality.

Key Path	Front-panel key
Initial S/W Revision	Prior to A.02.00

Sweep/Control

Accesses a menu that enables you to configure the Sweep and Control functions of the analyzer, such as Sweep Time and Gating.

Key Path	Front-panel key
Initial S/W Revision	Prior to A.02.00

Sweep Time

Controls the time the analyzer takes to sweep the current frequency span when the Sweep Type is Swept, and displays the equivalent Sweep Time when the Sweep Type is FFT.

When Sweep Time is in Auto, the analyzer computes a sweep time which will give accurate measurements based on other settings of the analyzer, such as RBW and VBW.

NOTE

The Meas Uncal (measurement uncalibrated) warning is given in the Status Bar in the lower right corner of the screen when the manual sweep time entered is faster than the sweep time computed by the analyzer's sweep time equations, that is, the Auto Sweep Time. The analyzer's computed sweep time will give accurate measurements; if you sweep faster than this your measurements may be inaccurate. A Meas Uncal condition may be corrected by returning the Sweep Time to Auto; by entering a longer Sweep Time; or by choosing a wider RBW

and/or VBW

On occasion other factors such as the Tracking Generator’s maximum sweep rate, the YTF sweep rate (in high band) or the LO’s capability (in low band) can cause a Meas Uncal condition. The most reliable way to correct it is to return the Sweep Time to Auto.

If the analyzer calculates that the Auto Sweep Time would be greater than 4000s (which is beyond its range), the warning message “Settings Alert;Sweep Rate Unavailable” is displayed. In this case increase the RBW or reduce the span.

If the analyzer’s estimated sweep time in an FFT sweep is greater than 4000s, the warning message “Settings Alert;Span:RBW Ratio too big” is displayed. In this case reduce the span or increase the RBW and/or FFT Width.

When Sweep Type is FFT, you cannot control the sweep time, it is simply reported by the analyzer to give you an idea of how long the measurement is taking.

Note that although some overhead time is required by the analyzer to complete a sweep cycle, the sweep time reported when Sweep Type is Swept does not include the overhead time, just the time to sweep the LO over the current Span. When Sweep Type is FFT, however, the reported Sweep Time takes into account both the data acquisition time and the processing time, in order to report an equivalent Sweep Time for a meaningful comparison to the Swept case.

Because there is no “Auto Sweep Time” when in zero span, the Auto/Man line on this key disappears when in Zero Span. The Auto/Man line also disappears when in an FFT sweep. In this case the key is grayed out as shown below.



NOTE When using a Tracking Source (**Source, Source Mode** set to “**Tracking**”), the sweep time shown includes an estimate of the source’s settling time. This estimate may contain inaccuracies, particularly when software triggering is used for the source. This can result in the reported sweep time being shorter than the actual sweep time.

Key Path	Sweep/Control
Remote Command	<pre>[:SENSe] :SWEep :TIME <time> [:SENSe] :SWEep :TIME? [:SENSe] :SWEep :TIME :AUTO OFF ON 0 1 [:SENSe] :SWEep :TIME :AUTO?</pre>
Example	<pre>SWE:TIME 500 ms SWE:TIME:AUTO OFF</pre>

Common Measurement Functions 1

Notes	The values shown in this table reflect the “swept spans” conditions which are the default settings after a preset. See “Couplings” for values in the zero span domain.
Dependencies	<p>The third line of the softkey (Auto/Man) disappears in Zero Span. The SCPI command SWEep:TIME:AUTO ON if sent in Zero Span generates an error message.</p> <p>Softkey grayed out and third line of the softkey (Auto/Man) disappears in FFT sweeps. Pressing the key or sending the SCPI for sweep time while the instrument is in FFT sweep generates a –221, “Settings Conflict;” error. F</p> <p>The SCPI command :SWEep:TIME:AUTO ON if sent in FFT sweeps generates an error.</p> <p>Grayed out while in Gate View, to avoid confusing those who want to set GATE VIEW Sweep Time.</p> <p>Key is grayed out in Measurements that do not support swept mode.</p> <p>Key is blanked in Modes that do not support swept mode.</p> <p>Set to Auto when Auto Couple is pressed or sent remotely</p>
Couplings	<p>Sweep Time is coupled primarily to Span and RBW. Center Frequency, VBW, and the number of sweep points also can have an effect. So changing these parameters may change the sweep time.</p> <p>The Sweep Time used upon entry to Zero Span is the same as the Sweep Time that was in effect before entering Zero Span. The Sweep Time can be changed while in Zero Span. Upon leaving Zero Span, the Auto/Man state of Sweep Time that existed before entering Zero Span is restored.</p> <p>If Sweep Time was in Auto before entering Zero Span, or if it is set to Auto while in zero span (which can happen via remote command or if Auto Couple is pressed) it returns to Auto and recouples when returning to non-zero spans.</p> <p>If Sweep Time was in Man before entering Zero Span, it returns to Man when returning to non-zero spans, and any changes to Sweep Time that were made while in Zero Span are retained in the non-zero span (except where constrained by minimum limits, which are different in and out of zero span).</p>
Preset	The preset Sweep Time value is hardware dependent since Sweep Time presets to “Auto”.
State Saved	Saved in instrument state
Min	<p>in zero span: 1 μs</p> <p>in swept spans: 1 ms</p> <p>in Stepped Tracking (as with option ESC): same as auto sweep time</p> <p>(in Swept Tracking, with Tracking Generator option T03 or T06, the minimum sweep time is 1 ms, but the Meas Uncal indicator is turned on for sweep times faster than 50 ms)</p>
Max	<p>in zero span: 6000 s</p> <p>in swept spans: 4000 s</p>

Status Bits/OPC dependencies	Meas Uncal is Bit 0 in the STATUS:QUESTIONable:INTEgrity:UNCalibrated register
Initial S/W Revision	Prior to A.02.00

Sweep Setup

Lets you set the sweep functions that control features such as sweep type and time.

Key Path	Sweep/Control
Dependencies	The whole Sweep Setup menu is grayed out in Zero Span, however, the settings in the menus under Sweep Setup can be changed remotely with no error indication. Grayed out in measurements that do not support swept mode. Blanked in modes that do not support swept mode
Initial S/W Revision	Prior to A.02.00

Sweep Time Rules

Allows the choice of three distinct sets of sweep time rules. These are the rules that are used to set the sweep time when **Sweep Time** is in **Auto mode**. Note that these rules only apply when in the Swept **Sweep Type** (either manually or automatically chosen) and not when in FFT sweeps.

See [“More Information” on page 1568](#).

Key Path	Sweep/Control, Sweep Setup
Remote Command	[:SENSe] :SWEep:TIME:AUTO:RULEs NORMal ACCuracy SRESponse [:SENSe] :SWEep:TIME:AUTO:RULEs?
Example	SWE:TIME:AUTO:RUL ACC
Dependencies	In Zero Span, this key is irrelevant and cannot be accessed (because the whole Sweep Setup menu is grayed out in Zero Span), however its settings can be changed remotely with no error indication. Grayed out in FFT sweeps. Pressing the key while the instrument is in FFT sweep generates an advisory message. The SCPI is acted upon if sent, but has no effect other than to change the readout on the key, as long as the analyzer is in an FFT sweep.
Couplings	Set to Auto on Auto Couple
Preset	AUTO
State Saved	Saved in instrument state
Backwards Compatibility SCPI	:SWEep:TIME:AUTO:MODE SRESponse This legacy command is aliased to :SWEep:TIME:AUTO:RULEs SRESponse

Common Measurement Functions 1

Backwards Compatibility SCPI	:SWEep:TIME:AUTO:MODE SANalyzer This legacy command is aliased to :SWEep:TIME:AUTO:RULEs NORMAl
Backwards Compatibility SCPI	:SWEep:TIME:AUTO:MODE? This legacy query is aliased to :SWEep:TIME:RULEs?, so it will match for SRESponse but not for SANalyzer
Backwards Compatibility Notes	The old Auto Sweep Time command was the same [:SENSe]:SWEep:TIME:AUTO:RULEs NORMAl ACCuracy so it still works although it now has a third parameter (SRESponse). The old Sweep Coupling command was [:SENSe]:SWEep:TIME:AUTO:MODE SRESponse SANalyzer and it is aliased as below:
Initial S/W Revision	Prior to A.02.00

More Information

The first set of rules is called **SA – Normal. Sweep Time Rules** is set to **SA-Normal** on a **Preset** or **Auto Couple**. These rules give optimal sweep times at a loss of accuracy. Note that this means that in the Preset or Auto Coupled state, instrument amplitude accuracy specifications do not apply.

Setting **Sweep Time Rules** to **SA-Accuracy** will result in slower sweep times than **SA-Normal**, usually about three times as long, but with better amplitude accuracy for CW signals. The instrument absolute amplitude accuracy specifications only apply when **Sweep Time** is set to **Auto**, and **Sweep Time Rules** are set to **SA-Accuracy**. Additional amplitude errors which occur when **Sweep Time Rules** are set to **SA-Normal** are usually well under 0.1 dB, though this is not guaranteed. Because of the faster sweep times and still low errors, **SA-Normal** is the preferred setting of **Sweep Time Rules**.

The third set of sweep time rules is called **Stimulus/Response** and is automatically selected when an integrated source is turned on, such as a Tracking Generator or a synchronized external source. The sweep times for this set of rules are usually much faster for swept-response measurements. Stimulus-response auto-coupled sweep times are typically valid in stimulus-response measurements when the system's frequency span is less than 20 times the bandwidth of the device under test. You can select these rules manually (even if not making Stimulus-Response measurements) which will allow you to sweep faster before the "Meas Uncal" warning comes on, but you are then not protected from the over-sweep condition and may end up with uncalibrated results. However, it is commonplace in measuring non-CW signals such as noise to be able to get excellent measurement accuracy at sweep rates higher than those required for CW signal accuracy, so this is a valid measurement technique.

Auto

Sets the analyzer to automatically choose the Sweep Time Rules for the measurement.

Key Path	Sweep/Control, Sweep Setup, Sweep Time Rules
Remote Command	[:SENSe] :SWEep:TIME:AUTO:RULEs:AUTO[:STATe] ON OFF 1 0 [:SENSe] :SWEep:TIME:AUTO:RULEs:AUTO[:STATe]?
Example	:SWE:TIME:AUTO:RUL:AUTO ON

Couplings	Set on Preset or Auto Couple
Preset	ON
Initial S/W Revision	Prior to A.02.00

SA - Normal

Chooses Sweep Time Auto Rules for optimal speed and generally sufficient accuracy.

Key Path	Sweep/Control, Sweep Setup, Sweep Time Rules
Example	:SWE:TIME:AUTO:RUL NORM
Dependencies	Not available (grayed out) when Source Mode=Tracking.
Couplings	Automatically selected unless Source is on If directly selected, sets AUTO to Off
Readback	SA - Normal
Initial S/W Revision	Prior to A.02.00

SA - Accuracy

Chooses Sweep Time Auto Rules for specified absolute amplitude accuracy.

NOTE For specified accuracy, do not allow sweep time to fall below 20 ms when in SA - Accuracy

Key Path	Sweep/Control, Sweep Setup, Sweep Time Rules
Example	:SWE:TIME:AUTO:RUL ACC
Dependencies	Not available (grayed out) when Source Mode=Tracking.
Couplings	If directly selected, sets AUTO to Off
Readback	SA - Accuracy
Initial S/W Revision	Prior to A.02.00

Stimulus/Response

The Stimulus-Response setting for sweep time rules provides different sweep time settings, for the case where the analyzer is sweeping in concert with a source. These modified rules take two forms:

1. Sweeping along with a swept source, which allows faster sweeps than the normal case because the RBW and VBW filters do not directly interact with the Span. We call this “Swept Tracking”
2. Sweeping along with a stepped source, which usually slows the sweep down because it is necessary to wait for the stepped source and the analyzer to settle at each point. We call this “Stepped Tracking”

Common Measurement Functions 1

The analyzer chooses one of these methods based on what kind of a source is connected or installed; it picks Swept Tracking if there is no source in use.

As always, when the X-series analyzer is in Auto Sweep Time, the sweep time is estimated and displayed in the Sweep/Control menu as well as in the annotation at the bottom of the displayed measurement; of course, since this can be dependent on variables outside the analyzer's control, the actual sweep time may vary slightly from this estimate.

You can always choose a shorter sweep time to improve the measurement throughput, (with some potential unspecified accuracy reduction), but the Meas Uncal indicator will come on if the sweep time you set is less than the calculated Auto Sweep time. You can also select a longer sweep time, which can be useful (for example) for obtaining accurate insertion loss measurements on very narrowband filters. The number of measurement points can also be reduced to speed the measurement (at the expense of frequency resolution).

Key Path	Sweep/Control, Sweep Setup, Sweep Time Rules
Example	:SWE:TIME:AUTO:RUL SRES
Couplings	Automatically selected when the Source is on (Source Mode not set to OFF). If directly selected sets AUTO to Off
Readback	SR
Initial S/W Revision	Prior to A.02.00

Sweep Type

Chooses between the FFT and Sweep types of sweep.

Sweep Type refers to whether or not the instrument is in Swept or FFT analysis. When in Auto, the selection of sweep type is governed by two different sets of rules, depending on whether you want to optimize for dynamic range or for speed.

FFT "sweeps" should not be used when making EMI measurements; therefore, when a CISPR detector (Quasi Peak, EMI Average, RMS Average) is selected for any active trace (one for which Update is on), the FFT key in the Sweep Type menu is grayed out, and the Auto Rules only choose Swept. If Sweep Type is manually selected to be FFT, the CISPR detectors are all grayed out.

FFT sweeps will never be auto-selected when Screen Video, Log Video or Linear Video are the selected Analog Output.

Key Path	Sweep/Control, Sweep Setup
Remote Command	[:SENSe] :SWEep:TYPE FFT SWEep [:SENSe] :SWEep:TYPE?

Dependencies	In Zero Span, this key is irrelevant and cannot be accessed (because the whole Sweep Setup menu is grayed out in Zero Span), however its settings can be changed remotely with no error indication. When Gate is on, Gate Method selection affects Sweep Type: Method FFT&Sweep menu FFT - Swept grayed out and rules choose FFT Video - FFT grayed out and rules choose Swept LO - FFT grayed out and rules choose Swept
Preset	AUTO
Backwards Compatibility SCPI	[[:SENSe]:SWEep:TYPE AUTO sets sweep type Auto to On but the query will return either FFT or SWE depending on the auto setting. [:SENSe]:SWEep:TYPE SWP selects sweep type Swept but will return SWE on a query
Initial S/W Revision	Prior to A.02.00

Auto

When in Auto, the selection of sweep type is governed by two different sets of rules, depending on whether you want to optimize for dynamic range or for speed. These rules are chosen under the **Sweep Type Rules** key.

Key Path	Sweep/Control, Sweep Setup, Sweep Type
Remote Command	[[:SENSe]:SWEep:TYPE:AUTO OFF ON 0 1 [:SENSe]:SWEep:TYPE:AUTO?
Example	:SWE:TYPE:AUTO ON
Couplings	Pressing Auto Couple always sets Sweep Type to Auto. Swept is always chosen whenever any form of Signal ID is on, or the Source Mode is set to Tracking, or any EMI detector is selected, or the RF Preselector is ON.
Preset	ON
State Saved	Saved in instrument state
Initial S/W Revision	Prior to A.02.00

Swept

Manually selects swept analysis, so it cannot change automatically to FFT.

Key Path	Sweep/Control, Sweep Setup, Sweep Type
Example	SWE:TYPE SWE

Common Measurement Functions 1

Dependencies	Grayed out while in Gated FFT (meaning Gate is ON and Gate Method is FFT). If this key is selected, the gate method Gated FFT is grayed out.
Couplings	This selection is chosen automatically if any of the CISPR detectors is chosen for any active trace, in which case the FFT Sweep Type selection is also grayed out.
State Saved	Saved in instrument state
Readback	Swept
Initial S/W Revision	Prior to A.02.00
Modified at S/W Revision	A.02.00

FFT

Manually selects FFT analysis, so it cannot change automatically to Swept.

Key Path	Sweep/Control, Sweep Setup, Sweep Type
Example	SWE:TYPE FFT
Dependencies	When a CISPR detector (Quasi Peak, EMI Average, RMS Average) is selected for any active trace, the FFT key is grayed out. When the RF Preselector is on, the FFT key is grayed out. When Source Mode is set to Tracking, Manual FFT is grayed out. When Signal ID is on, Manual FFT is grayed out. Grayed out while in Gated LO (meaning Gate is ON and Gate Method is LO). Grayed out while in Gated Video (meaning Gate is ON and Gate Method is Video).
State Saved	Saved in instrument state
Readback	FFT
Initial S/W Revision	Prior to A.02.00

Sweep Type Rules

Selects which set of rules will be used for automatically choosing the Sweep Type when Sweep Type is in Auto.

Key Path	Sweep/Control, Sweep Setup
Remote Command	[:SENSE] :SWEep:TYPE:AUTO:RULEs SPEed DRANge [:SENSE] :SWEep:TYPE:AUTO:RULEs?
Dependencies	In Zero Span, this key is irrelevant and cannot be accessed (because the whole Sweep Setup menu is grayed out in Zero Span), however its settings can be changed remotely with no error indication.

Preset	DRANge
State Saved	Saved in instrument state
Backwards Compatibility Notes	The legacy parameter DYNamicrange is unsupported
Initial S/W Revision	Prior to A.02.00

Auto

This selection is automatically chosen when Auto Couple is pressed. When in Auto, the Sweep Type Rules are set to Best Dynamic Range. It seems like a very simple Auto function but the use of this construct allows a consistent statement about what the Auto Couple key does.

Key Path	Sweep/Control, Sweep Setup, Sweep Type Rules
Remote Command	[:SENSe] :SWEep :TYPE :AUTO :RULes :AUTO [:STATe] OFF ON 0 1 [:SENSe] :SWEep :TYPE :AUTO :RULes :AUTO [:STATe] ?
Example	:SWE:TYPE:AUTO:RUL:AUTO ON
Couplings	Pressing Auto Couple always sets Sweep Type Rules to Auto.
Preset	ON
State Saved	Saved in instrument state
Initial S/W Revision	Prior to A.02.00

Best Dynamic Range

This selection tells the analyzer to choose between swept and FFT analysis with the primary goal of optimizing dynamic range. If the dynamic range is very close between swept and FFT, then it chooses the faster one. This auto selection also depends on RBW Type.

In determining the Swept or FFT setting, the auto rules use the following approach:

- If the RBW Filter Type is Gaussian use the RBW for the Normal Filter BW and if that RBW > 210 Hz, use swept; for RBW <= 210 Hz, use FFT
- If the RBW Filter Type is Flat Top, use the same algorithm but use 420 Hz instead of 210 Hz for the transition point between Swept and FFT
- If any of the CISPR detectors is chosen for any active trace, always use Swept.

Key Path	Sweep/Control, Sweep Setup, Sweep Type Rules
Example	SWE:TYPE:AUTO:RUL DRAN sets the auto rules to dynamic range.
Couplings	Directly selecting this setting sets AUTO to OFF.
Readback	Dynamic Range
Initial S/W Revision	Prior to A.02.00

Common Measurement Functions 1

Best Speed

This selection tells the analyzer to choose between FFT or swept analysis based on the fastest analyzer speed.

Key Path	Sweep/Control, Sweep Setup, Sweep Type Rules
Example	SWE:TYPE:AUTO:RUL SPE sets the rules for the auto mode to speed
Couplings	Directly selecting this setting sets AUTO to OFF.
Readback	Speed.
Initial S/W Revision	Prior to A.02.00

FFT Width

This menu displays and controls the width of the FFT's performed while in FFT mode. The "FFT width" is the range of frequencies being looked at by the FFT, sometimes referred to as the "chunk width" -- it is not the resolution bandwidth used when performing the FFT.

It is important to understand that this function does not directly set the FFT width, it sets the limit on the FFT Width. The actual FFT width used is determined by several other factors including the Span you have set. Usually the instrument picks the optimal FFT Width based on the current setup; but on occasion you may wish to limit the FFT Width to be narrower than that which the instrument would have set.

NOTE This function does not allow you to widen the FFT Width beyond that which the instrument might have set; it only allows you to narrow it. You might do this to improve the dynamic range of the measurement or eliminate nearby spurs from your measurement.

Note that the **FFT Width** setting will have no effect unless in an FFT sweep.

See "[More Information](#)" on page 1576

Key Path	Sweep/Control, Sweep Setup
Remote Command	[:SENSE] :SWEep:FFT:WIDTh <real> [:SENSE] :SWEep:FFT:WIDTh?
Example	SWE:FFT:WIDTh 167 kHz sets this function to "<167.4 kHz"
Notes	The parameter is in units of frequency. For values sent from SCPI, the analyzer chooses the smallest value that is at least as great as the requested value. Examples: Parameter 3.99 kHz is sent over SCPI. Analyzer chooses 4.01 kHz Parameter 4.02 kHz is sent over SCPI. Analyzer chooses 28.81 kHz Parameter 8 MHz is sent over SCPI. Analyzer chooses 10 MHz

Dependencies	<p>In some models, the analog prefilters are not provided. In these models the FFT Width function is always in Auto. The FFT Width key is blanked in these models, and the SCPI commands are accepted without error but have no effect.</p> <p>In Zero Span, this key is irrelevant and cannot be accessed (because the whole Sweep Setup menu is grayed out in Zero Span). However, its settings can be changed remotely with no error indication.</p>
Couplings	The FFT Width affects the ADC Dither function (see Meas Setup key) and the point at which the instrument switches from Swept to FFT acquisition.
Preset	The Preset is Auto, but Preset will also pick Best Dynamic Range and hence this function will be set to ~Maximum
State Saved	Saved in instrument state
Min	4.01 kHz
Max	<p>The maximum available FFT width is dependent on the IF Bandwidth option. The maximum available width is:</p> <p>Option B10, 10 MHz;</p> <p>Option B25, 25 MHz,</p> <p>Option B40, 40 MHz.</p>
Backwards Compatibility SCPI	<p><code>[:SENSe]:SWEep:FFT:SPAN:RATio <integer></code></p> <p><code>[:SENSe]:SWEep:FFT:SPAN:RATio?</code></p> <p>This is the legacy “FFTs per Span” command, because in the PSA, this is what you set rather than the FFT Width. The behavior of the analyzer when it receives this command is to compute the “intended segment width” by dividing the Span by the FFTs/Span parameter, then converting this intended width to an actual width by using the largest available FFT Width that is still less than the intended segment width. The “Span” used in this computation is whatever the Span is currently set to, whether a sweep has been taken at that Span or not.</p>
Initial S/W Revision	Prior to A.02.00
Modified at S/W Revision	A.04.00

Key Path	Sweep/Control, Sweep Setup
Remote Command	<p><code>[:SENSe] :SWEep:FFT:WIDTh:AUTO OFF ON 0 1</code></p> <p><code>[:SENSe] :SWEep:FFT:WIDTh:AUTO?</code></p>
Example	<code>:SWE:FFT:WIDT:AUTO ON</code>
Couplings	Pressing Auto Couple always sets FFT Width to Auto.
Preset	ON
State Saved	Saved in instrument state
Initial S/W Revision	Prior to A.02.00

More Information

An FFT measurement can only be performed over a limited span known as the “FFT segment”. Several segments may need to be combined to measure the entire span. For advanced FFT control in the X-Series, you have direct control over the segment width using the **FFT Width** control. Generally, in automatic operation, the X-Series sets the segment width to be as wide as possible, as this results in the fastest measurements.

However, in order to increase dynamic range, most X-series models provide a set of analog prefilters that precede the ADC. Unlike swept measurements, which pass the signal through a bandpass before the ADC, FFT measurements present the full signal bandwidth to the ADC, making them more susceptible to overload, and requiring a lower signal level. The prefilters act to alleviate this phenomenon - they allow the signal level at the ADC to be higher while still avoiding an ADC overload, by eliminating signal power outside the bandwidth of interest, which in turn improves dynamic range.

Although narrowing the segment width can allow higher dynamic ranges some cases, this comes at the expense of losing some of the speed advantages of the FFT, because narrower segments require more acquisitions and proportionately more processing overhead.

However, the advantages of narrow segments can be significant. For example, in pulsed-RF measurements such as radar, it is often possible to make high dynamic range measurements with signal levels approaching the compression threshold of the analyzer in swept spans (well over 0 dBm), while resolving the spectral components to levels below the maximum IF drive level (about -8 dBm at the input mixer). But FFT processing experiences overloads at the maximum IF drive level even if the RBW is small enough that no single spectral component exceeds the maximum IF drive level. If you reduce the width of an FFT, an analog filter is placed before the ADC that is about 1.3 times as wide as the FFT segment width. This spreads out the pulsed RF in time and reduces the maximum signal level seen by the ADC. Therefore, the input attenuation can be reduced and the dynamic range increased without overloading the ADC.

Further improvement in dynamic range is possible by changing the **FFT IF Gain** (in the **Meas Setup** menu of many measurements). If the segments are reduced in width, **FFT IF Gain** can be set to High, improving dynamic range.

Depending on what IF Bandwidth option you have ordered, there can be up to three different IF paths available in FFT sweeps, as seen in the diagram below:

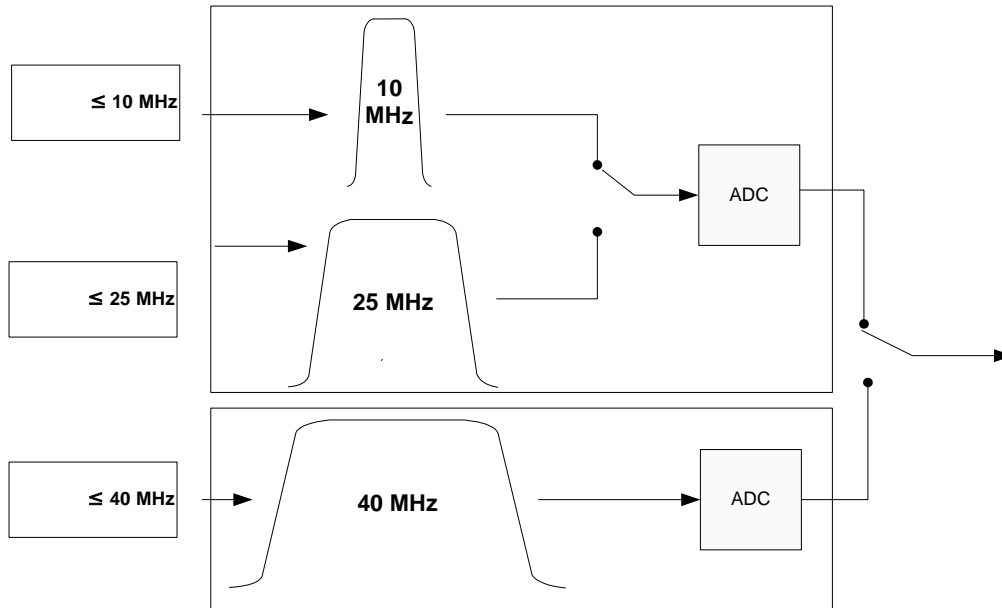

The 10 MHz path is always used for Swept sweeps. It is always used for FFT sweeps as well, unless the user specifies ~ 25 MHz in which case the 25 MHz path will be used for FFT sweeps, or ~ 40 MHz, in which case the 40 MHz path will be used for FFT sweeps. Note that, although each of these keys picks the specified path, the analyzer may choose an FFT width less than the full IF width, in order to optimize speed, trading off acquisition time versus processing time.

Pause/Resume

Pauses a measurement after the current data acquisition is complete.

When Paused, the label on the key changes to Resume. Pressing Resume un-pauses the measurement. When you are Paused, pressing **Restart**, **Single** or **Cont** does a Resume.

Key Path	Sweep/Control
Remote Command	:INITiate:PAUSE
Dependencies	Grayed out in Measurements that do not support Pausing. Blanked in Modes that do not support Pausing.
Initial S/W Revision	Prior to A.02.00

Key Path	Sweep/Control
Remote Command	:INITiate:RESume
Dependencies	Grayed out in Measurements that do not support Pausing. Blanked in Modes that do not support Pausing.
Initial S/W Revision	Prior to A.02.00

Common Measurement Functions 1

Gate

Accesses a menu that enables you to control the gating function. The Gate functionality is used to view signals best viewed by qualifying them with other events.

Gate setup parameters are the same for all measurements – they do not change as you change measurements. Settings like these are called “Meas Global” and are unaffected by Meas Preset.

Note that Sweep Time autocoupling rules and annotation are changed by Gate being on.

Key Path	Sweep/Control
Scope	Meas Global
Readback	The state and method of Gate, as [Off, LO] or [On, Video]. Note that for measurements that only support gated LO, the method is nonetheless read back, but always as LO.
Initial S/W Revision	Prior to A.02.00

Gate On/Off

Turns the gate function on and off.

When the Gate Function is on, the selected Gate Method is used along with the gate settings and the signal at the gate source to control the sweep and video system with the gate signal. Not all measurements allow every type of Gate Methods.

When Gate is on, the annunciation in the measurement bar reflects that it is on and what method is used, as seen in the following "Gate: LO" annunciator graphic.

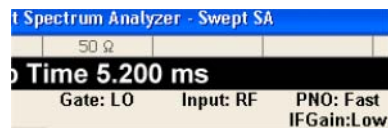

Key Path	Sweep/Control, Gate
Remote Command	[:SENSe] :SWEep :EGATe [:STATe] OFF ON 0 1 [:SENSe] :SWEep :EGATe [:STATe] ?
Example	SWE:EGAT ON SWE:EGAT ?

Dependencies	<p>The function is unavailable (grayed out) and Off when:</p> <ul style="list-style-type: none"> • Gate Method is LO or Video and FFT Sweep Type is manually selected. • Gate Method is FFT and Swept Sweep Type is manually selected. • Marker Count is ON. <p>The following are unavailable whenever Gate is on:</p> <ul style="list-style-type: none"> • FFT under Sweep Type when Method=LO or Video or Swept under Sweep Type when Method=FFT • Marker Count <p>While Gate is on, the Auto Rules for Sweep Type are modified so that the choice agrees with the Gate Method: i.e., FFT for Method = FFT and Swept for Method = LO or Video.</p> <p>The Gate softkey and all SCPI under the [:SENSe]:SWEep:EGATe SCPI node are grayed out when Source Mode is Tracking with an external source. This is because the Gate circuitry is used to sync the external source. If the Tracking Source is turned on, the Gate is turned off.</p>
Couplings	<p>When Meas Method is RBW or FAST, this function is unavailable and the key is grayed out.</p> <p>Whenever Gate is on, Meas Method, RBW or FAST is unavailable and keys for those are grayed out.</p> <p>When Gate is on, Offset Res BW and Offset Video BW are ignored (if you set these values) and the measurement works as if all Offset Res BW and all Offset Video BW are coupled with the Res BW and the Video BW under the BW menu. When Gate is on, the Offset BW key in the Offset/Limit menu is grayed out.</p>
Preset	Off
State Saved	Saved in instrument state
Range	On Off
Backwards Compatibility SCPI	[:SENSe]:SWEep:TIME:GATE[:STATe] ESA compatibility
Backwards Compatibility Notes	In ESA, Trig Delay (On) and Gate (On) could not be active at the same time.. This dependency does not exist in PSA or in the X-Series.
Initial S/W Revision	Prior to A.02.00

Gate View On/Off

Turning on Gate View in the Swept SA measurement provides a single-window gate view display..

Turning on Gate View in other measurements shows the split-screen Gate View. In these measurements, when the Gate View is on, the regular view of the current measurement traces and results are reduced vertically to about 70% of the regular height. The Zero Span window, showing the positions of the Gate, is shown between the Measurement Bar and the reduced measurement window. By reducing the height

Common Measurement Functions 1

of the measurement window, some of the annotation on the Data Display may not fit and is not shown.

Key Path	Sweep/Control, Gate
Remote Command	[:SENSE] :SWEep:EGATe:VIEW ON OFF 1 0 [:SENSe] :SWEep:EGATe:VIEW?
Example	SWE:EGAT:VIEW ON turns on the gate view.
Dependencies	In the Swept SA measurement: In Gate View, the regular Sweep Time key is grayed out . When pressed, the grayed out key puts up the informational message "Use Gate View Sweep Time in the Gate menu." In the other measurements: When you turn Gate View on, the lower window takes on the current state of the instrument. Upon leaving Gate View, the instrument takes on the state of the lower window. When you turn Gate View on, the upper window Sweep Time is set to the gate view sweep time.
Couplings	These couplings apply to the Swept SA measurement: <ul style="list-style-type: none"> • When Gate View is turned on, the instrument is set to Zero Span. • Gate View automatically turns off whenever a Span other than Zero is selected. • Gate View automatically turns off if you press the Last Span key while in Gate View, and the instrument returns to the Span it was in before entering Gate View (even if that is Zero Span). • When Gate View is turned on, the sweep time used is the gate view sweep time. This is set according to the rules in section “Gate View Setup ” on page 1582 • When Gate View is turned off, Sweep Time is set to the normal Swept SA measurement sweep time. • If Gate View is on and Gate is off, then turning on Gate turns off Gate View.
Preset	OFF
State Saved	Saved in instrument state
Range	On Off
Initial S/W Revision	Prior to A.02.00

A sample of the Gate View screen in the Swept SA measurement is shown in the following graphic :

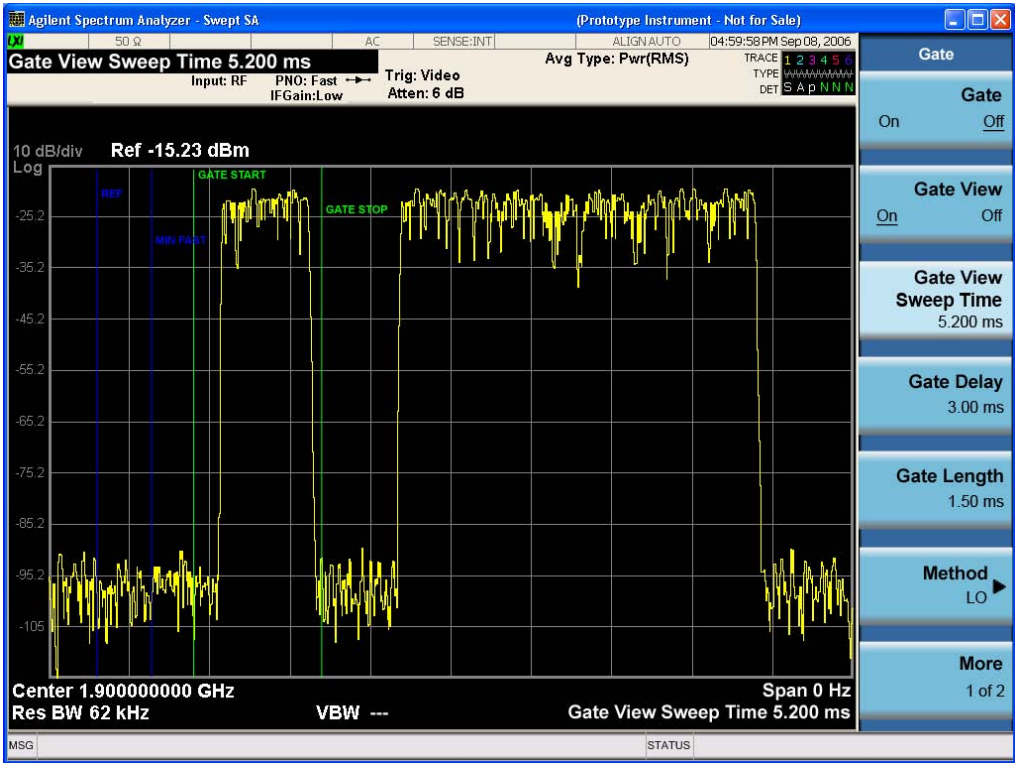

A sample of the Gate View screen in other measurements is shown in the following graphic . This example is for the ACP measurement:

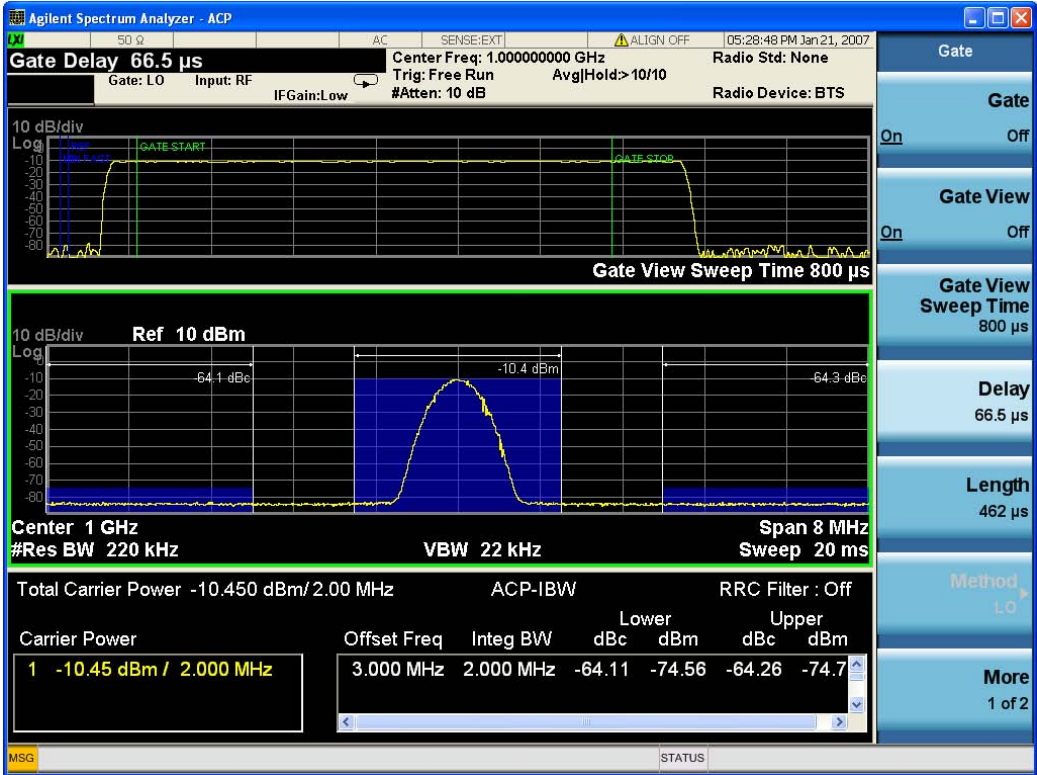

Common Measurement Functions 1

Turning Gate View off returns the analyzer to the Normal measurement view.

In the Swept SA, the normal measurement view is the single-window Swept SA view. When returning to this view, the Swept SA measurement returns to the Span it was in before entering **Gate View** (even if that is Zero Span).

The **Gate View** window is triggered from the Gate Source, with zero trigger delay. Also, when updating the **Gate View** window, the Gate itself must not operate. So it is internally shut off while the gate view window is being updated. For the Swept SA measurement, this means that the Gate is internally shut off whenever the gate view window is displayed. The measurement bar and softkeys continue to show the Trigger source for the main sweep window and give no indication that the Gate is shut off or that the Gate View window is triggered from the Gate Source.

When in **Gate View**, vertical lines are displayed in the Gate View window as follows:

- Green lines are displayed at the gate edges as follows: in Edge Gate, a line is shown for Delay and one for the end of the Gate period (defined by Length, even in FFT. In Level Gate a line is shown only for Delay. You can adjust the position of the green lines by adjusting the gate length and the gate delay. These lines update in the Gate View window as the active function changes, even if the window is not being updated. In Gated LO and Gated Video, these lines are positioned relative to the delay reference line (not relative to 0 time). In Gated FFT, their location is relative to the left edge of the screen.
- A blue line is displayed showing the delay reference, that is, the reference point for the Gate Delay within the Zero Span window. The blue line represents where (in time) the effective location of the gate start would be if the gate were programmed to zero delay.
- The second blue line is labeled "MIN FAST" as shown in the figure above because it represents the minimum Gate Delay for fast Gated LO operation. This line is only displayed in Gated LO. You cannot scroll (knob) or decrement (down key) the Gate Delay to less than that represented by the position of this line, it can only be set below this position manually, although once there it can be moved freely with the knob while below the line.
- A yellow line in the Gated Video case only, is displayed at B_{length} , where B_{length} is the display point (bucket) length for the swept trace, which is given by the sweep time for that trace divided by number of Points – 1. So it is referenced to 0 time, not to the delay reference. This line is labeled NEXT PT (it is not shown in the figure above because the figure above is for Gated LO). The yellow line represents the edge of a display point (bucket). Normally in Gated Video, the bucket length must be selected so that it exceeds the off time of the burst. There is another way to use the analyzer in Gated Video measurements, and that is to set the bucket width much shorter than the off time of the burst. Then use the Max Hold trace function to fill in "missing" buckets more slowly. This allows you to see some of the patterns of the Gated Video results earlier, though seeing a completely filled-in spectrum later.

Gate View Setup

Accesses a menu that enables you to setup parameters relevant to the Gate View

Key Path	Sweep/Control, Gate
Scope	Meas Global
Initial S/W Revision	A.10.00

Gate View Sweep Time

Controls the sweep time in the Gate View window. To provide an optimal view of the gate signal, the analyzer initializes Gate View Sweep Time based on the current settings of Gate Delay and Gate Length.

Key Path	Sweep/Control, Gate, Gate View Setup
Remote Command	[:SENSe] :SWEep:EGATe:TIME <time> [:SENSe] :SWEep:EGATe:TIME?
Example	SWE:EGAT:TIME 500 ms
Dependencies	Gate View Sweep Time is initialized: On Preset (after initializing delay and length). Every time the Gate Method is set/changed. Additionally, in the Swept SA measurement, whenever you do a Preset, or leave Gate View, the analyzer remembers the Gate Delay and Gate Length settings. Then, when returning to Gate View, if the current Gate Delay and/or Gate Length do not match the remembered values Gate View Sweep Time is re-initialized. Compute the location of the "gate stop" line, which you know is at time $t = t_{\min} + \text{GateDelay} + \text{GateLength}$.
Preset	519.3 μ s WiMAX OFDMA: 5 ms GSM/EDGE: 1 ms
State Saved	Saved in instrument state
Min	1 μ s
Max	6000 s
Initial S/W Revision	Prior to A.02.00

Gate View Start Time

Controls the time at the left edge of the Gate View.

Key Path	Sweep/Control, Gate, Gate View Setup
Remote Command	[:SENSe] :SWEep:EGATE:VIEW:START <time> [:SENSe] :SWEep:EGATE:VIEW:START?
Example	SWE:EGAT:VIEW:STAR 10ms
Notes	Units of time are required or no units; otherwise an invalid suffix error message will be generated. See error -131.
Preset	0 ms
State Saved	Saved in instrument state

Common Measurement Functions 1

Min	0
Max	500 ms
Initial S/W Revision	A.10.00

Gate Delay

Controls the length of time from the time the gate condition goes True until the gate is turned on.

Key Path	Sweep/Control, Gate
Remote Command	[:SENSE] :SWEep:EGATe:DELay <time> [:SENSE] :SWEep:EGATe:DELay?
Example	SWE:EGAT:DELay 500ms SWE:EGAT:DELay?
Notes	Units of time are required or no units; otherwise an invalid suffix error message will be generated. See error -131.
Preset	57.7 us WiMAX OFDMA: 71 us GSM/EDGE: 600 us
State Saved	Saved in instrument state
Min	0.0 us
Max	100 s
Backwards Compatibility SCPI	[:SENSE] :SWEep:TIME:GATE:DELay ESA compatibility
Initial S/W Revision	Prior to A.02.00

Gate Length

Controls the length of time that the gate is on after it opens.

Key Path	Sweep/Control, Gate
Remote Command	[:SENSE] :SWEep:EGATe:LENGth <time> [:SENSE] :SWEep:EGATe:LENGth?
Example	SWE:EGAT:LENG 1 SWE:EGAT:LENG?
Notes	Units of time are required or no units; otherwise an invalid suffix error message will be generated.

Dependencies	<p>Grayed out when Gate Method is set to FFT in which case the label changes to that shown below.</p> <div style="border: 1px solid black; padding: 5px; display: inline-block;"> <p>Gate Length (=1.83/RBW) 2.8 ms</p> </div> <p style="margin-left: 20px;">vsd 39-1</p> <p>The key is also grayed out if Gate Control = Level.</p>
Preset	<p>461.6 us</p> <p>WiMAX OFDMA: 50 us</p> <p>GSM/EDGE: 200 us</p>
State Saved	Saved in instrument state
Min	100 ns
Max	5 s
Backwards Compatibility SCPI	[:SENSe]:SWEep:TIME:GATE:LENGth ESA compatibility
Initial S/W Revision	Prior to A.02.00

Method

This lets you choose one of the three different types of gating.

Not all types of gating are available for all measurements.

Key Path	Sweep/Control, Gate
Remote Command	<p>[:SENSe] :SWEep:EGATe:METhod LO VIDEo FFT</p> <p>[:SENSe] :SWEep:EGATe:METhod?</p>
Example	SWE:EGAT:METh FFT
Preset	LO
State Saved	Saved in instrument state
Initial S/W Revision	Prior to A.02.00

LO

When Gate is set to On, the LO sweeps whenever the gate conditions as specified in the Gate menu are satisfied by the signal at the Gate Source.

This form of gating is more sophisticated, and results in faster measurements. With Gated LO, the analyzer only sweeps while the gate conditions are satisfied. This means that a sweep could take place over several gate events. It would start when the gate signal goes true and stop when it goes false, and then continue when it goes true again. But since the LO is sweeping as long as the gate conditions are satisfied, the sweep typically finishes much more quickly than with Gated Video.

When in zero span, there is no actual sweep performed. But data is only taken while the gate conditions are

Common Measurement Functions 1

satisfied. So even though there is no sweep, the gate settings will impact when data is acquired.

Key Path	Sweep/Control, Gate, Method
Dependencies	Key is unavailable when Gate is On and FFT Sweep Type manually selected. When selected, Sweep Type is forced to Swept and the FFT key in Sweep Type is grayed out.
Readback	LO
Initial S/W Revision	Prior to A.02.00

Video

When Gate is set to On, the video signal is allowed to pass through whenever the gate conditions as specified in the Gate menu are satisfied by the signal at the Gate Source.

This form of gating may be thought of as a simple switch, which connects the signal to the input of the spectrum analyzer. When the gate conditions are satisfied, the switch is closed, and when the gate conditions are not satisfied, the switch is open. So we only look at the signal while the gate conditions are satisfied.

With this type of gating, you usually set the analyzer to sweep very slowly. In fact, a general rule is to sweep slowly enough that the gate is guaranteed to be closed at least once per data measurement interval (bucket). Then if the peak detector is used, each bucket will represent the peak signal as it looks with the gate closed.

Key Path	Sweep/Control, Gate, Method
Dependencies	Key is unavailable when Gate is On and FFT Sweep Type manually selected. When selected, Sweep Type is forced to Swept and the FFT key in Sweep Type is grayed out
Readback	Video
Initial S/W Revision	Prior to A.02.00

FFT

When Gate is set to On, an FFT is performed whenever the gate conditions as specified in the Gate menu are satisfied by the signal at the Gate Source. This is an FFT measurement which begins when the gate conditions are satisfied. Since the time period of an FFT is approximately $1.83/\text{RBW}$, you get a measurement that starts under predefined conditions and takes place over a predefined period. So, in essence, this is a gated measurement. You have limited control over the gate length but it works in FFT sweeps, which the other two methods do not.

Gated FFT cannot be done in zero span since the instrument is not sweeping. So in zero span the Gated LO method is used. Data is still only taken while the gate conditions are satisfied, so the gate settings do impact when data is acquired.

The Gate Length will be $1.83/\text{RBW}$.

This is a convenient way to make a triggered FFT measurement under control of an external gating signal.

Key Path	Sweep/Control, Gate
----------	---------------------

Dependencies	Key is unavailable when Gate is On and Swept Sweep Type manually selected. Key is unavailable when gate Control is set to Level. When selected, Sweep Type is forced to FFT and the Swept key in Sweep Type is grayed out Forces Gate Length to 1.83/RBW
Readback	FFT
Initial S/W Revision	Prior to A.02.00

Gate Source

The menus under the **Gate Source** key follow the same pattern as those under the **Trigger key**, with the exception that neither **Free Run** nor **Video** are available as Gate Source selections. Any changes to the settings in the setup menus under each Gate Source selection key (for example: **Trigger Level**) also affect the settings under the Trigger menu keys. Note that the selected Trigger Source does not have to match the Gate Source.

Key Path	Sweep/Control, Gate
Remote Command	[:SENSe] :SWEep:EGATe:SOURce EXTernal1 EXTernal2 LINE FRAMe RFBurst [:SENSe] :SWEep:EGATe:SOURce?
Dependencies	In some models, there is no second External input. In these models, the External 2 key is blanked and the EXTernal2 parameter will generate a “Hardware missing; Not available for this model number” error.
Preset	EXTernal 1 GSM/EDGE: FRAMe
Backwards Compatibility Notes	In ESA, there is a single Gate input port. In PSA, the Gate Source may be taken from one of two specified input ports. In the X-Series, any Trigger Source can be a Gate Source.
Initial S/W Revision	Prior to A.02.00
Modified at S/W Revision	A.03.00

Control Edge/Level

Sets the method of controlling the gating function from the gating signal.

Edge

In Edge triggering, the gate opens (after the Delay) on the selected edge (for example, positive) of the gate signal and closes on the alternate edge (for example, negative).

Level

In Level triggering, the gate opens (after the Delay) when the gate signal has achieved a certain level and

Common Measurement Functions 1

stays open as long as that level is maintained.

Key Path	Sweep/Control, Gate
Remote Command	[:SENSE] :SWEep:EGATe:CONTRol EDGE LEVe1 [:SENSE] :SWEep:EGATe:CONTRol?
Example	SWE:EGAT:CONT EDGE
Dependencies	If the Gate Method is FFT the Control key is grayed out and Edge is selected. If the Gate Source is TV, Frame or Line, the Control key is grayed out and Edge is selected.
Preset	EDGE
State Saved	Saved in instrument state
Backwards Compatibility SCPI	[:SENSE] :SWEep:TIME:GATE:TYPE ESA Compatibility
Initial S/W Revision	Prior to A.02.00

Gate Holdoff

Lets you increase or decrease the wait time after a gate event ends before the analyzer will respond to the next gate signal.

After any Gate event finishes, the analyzer must wait for the sweep system to settle before it can respond to another Gate signal. The analyzer calculates a "wait time," taking into account a number of factors, including RBW and Phase Noise Optimization settings. The goal is to achieve the same accuracy when gated as in ungated operation. The figure below illustrates this concept:

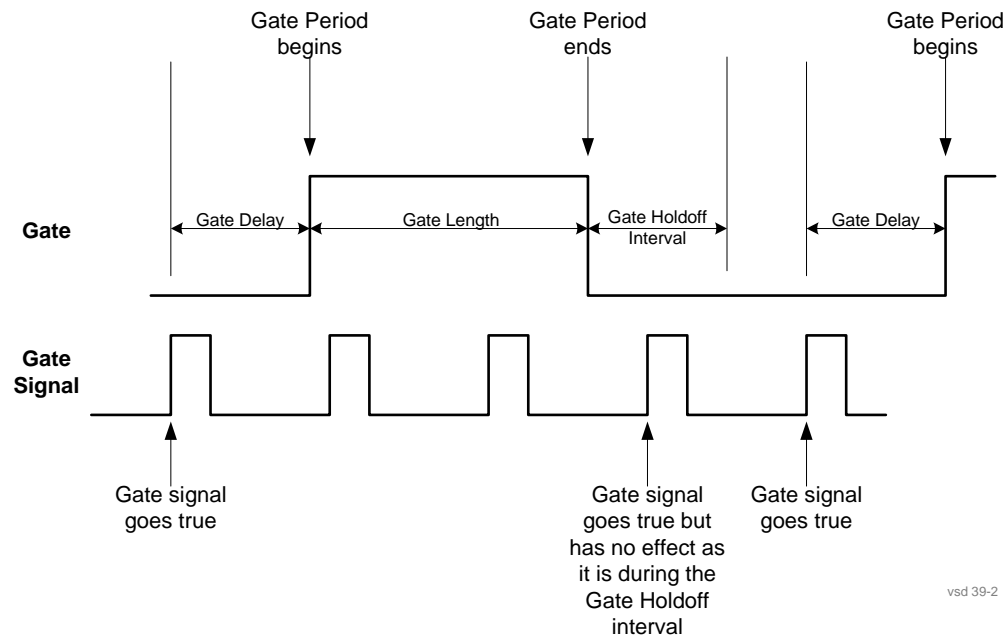

When Gate Holdoff is in Auto, the wait time calculated by the analyzer is used. When Gate Time is in Manual, the user may adjust the wait time, usually decreasing it in order to achieve greater speed, but at

the risk of decreasing accuracy.

When the **Method** key is set to **Video** or **FFT**, the **Gate Holdoff** function has no effect.

In measurements that do not support Auto, the value shown when Auto is selected is “---“ and the manually set holdoff is returned to a query.

Key Path	Sweep/Control, Gate
Remote Command	[:SENSe]:SWEep:EGATe:HOLDoff <time> [:SENSe]:SWEep:EGATe:HOLDoff? [:SENSe]:SWEep:EGATe:HOLDoff:AUTO OFF ON 0 1 [:SENSe]:SWEep:EGATe:HOLDoff:AUTO?
Example	SWE:EGAT:HOLD 0.0002 SWE:EGAT:HOLD? SWE:EGAT:HOLD:AUTO ON SWE:EGAT:HOLD:AUTO?
Couplings	When Gate Holdoff is Auto , the Gate Holdoff key shows the value calculated by the analyzer for the wait time. Pressing the Gate Holdoff key while it is in Auto and not selected, causes the key to become selected and allows the user to adjust the value. If the value is adjusted, the setting changes to Man . Pressing the Gate Holdoff key, while it is in Auto and selected, does not change the value of Gate Holdoff , but causes the setting to change to Man . Now the user can adjust the value. Pressing the key while it is in Man and selected, cause the value to change back to Auto . Pressing the key while it is in Man and not selected, causes the key to become selected and allows the user to adjust the value. When Method is set to Video or FFT , the Gate Holdoff function has no effect.
Preset	Auto Auto/On
State Saved	Saved in instrument state
Min	1 μsec
Max	1 sec
Initial S/W Revision	Prior to A.02.00

Gate Delay Compensation

This function allows you to select an RBW-dependent value by which to adjust the gate delay, to compensate for changes in the delay caused by RBW effects.

You can select between uncompensated operation and two types of compensation, **Delay Until RBW**

Common Measurement Functions 1

Settled and Compensate for RBW Group Delay.

See “More Information” on page 1590

Key Path	Sweep/Control, Gate
Scope	Meas Global
Remote Command	[:SENSE] :SWEep:EGATe:DELAy:COMPensation:TYPE OFF SETTled GDELAy [:SENSE] :SWEep:EGATe:DELAy:COMPensation:TYPE?
Example	SWE:EGAT:DEL:COMP:TYPE SETT SWE:EGAT:DEL:COMP:TYPE?
Notes	Although this function is Meas Global, there are some measurements that do not support this function. In those measurements the operation will be Uncompensated. Going into one of those measurements will not change the Meas Global selection; it will simply display the grayed-out menu key with “Uncompensated” showing as the selection. This is a non-forceful grayout, so the SCPI command is still accepted. If Gate Delay Compensation is not supported at all within a particular mode, the key is not displayed, and if the SCPI command is sent while in a measurement within that mode, an “Undefined Header” message is generated. Measurements that do not support this function include: Swept SA
Preset	TD-SCDMA mode: Compensate for RBW Group Delay All other modes: Delay Until RBW Settled
State Saved	Saved in instrument state
Range	Uncompensated Delay Until RBW Settled Compensate for RBW Group Delay
Readback text	Uncompensated Settled Group Delay
Initial S/W Revision	Prior to A.02.00

More Information

Selecting **Uncompensated** means that the actual gate delay is as you sets it.

Selecting **Delay Until RBW Settled** causes the gate delay to be increased above the user setting by an amount equal to $3.06/\text{RBW}$. This compensated delay causes the GATE START and GATE STOP lines on the display to move by the compensation amount, and the actual hardware gate delay to be increased by the same amount. All the other gate lines (for example, MIN FAST) are unaffected. If the RBW subsequently changes, the compensation is readjusted for the new RBW. The value shown on the **Gate Delay** key does NOT change.

Delay Until RBW Settled allows excellent measurements of gated signals, by allowing the IF to settle following any transient that affects the burst. Excellent measurements also require that the analysis region not extend into the region affected by the falling edge of the burst. Thus, excellent measurements

can only be made over a width that declines with narrowing RBWs. Therefore, for general purpose compensation, you will still want to change the gate length with changes in RBW even if the gate delay is compensated.

Selecting **Compensate for RBW Group Delay** causes the gate delay to be increased above the user setting by an amount equal to $1.81/\text{RBW}$. This compensated delay causes the GATE START, GATE STOP lines on the display to move by the compensation amount, and the actual hardware gate delay to be increased by the same amount. All the other gate lines (for example, MIN FAST) are unaffected. If the RBW subsequently changes, the compensation is readjusted for the new RBW. The value shown on the **Gate Delay** key does NOT change. **Compensate for RBW Group Delay** also includes gate length compensation; the gate length itself is adjusted as necessary to attempt to compensate for delay effects imposed by the RBW.

Compensate for RBW Group Delay is similar to **Delay Until RBW Settled**, but compensates for the group delay of the RBW filter, rather than the filter settling time. As the RBW gets narrow, this can allow the settling tail of the RBW to affect the beginning part of the gated measurement, and allow the beginning of the RBW settling transient to affect the end of the gated measurement. These two effects are symmetric because the RBW response is symmetric. Because the gate length is not automatically compensated, some users might find this compensation to be more intuitive than compensation for RBW settling.

Min Fast Position Query (Remote Command Only)

This command queries the position of the MIN FAST line, relative to the delay reference (REF) line. See section [“Gate View On/Off” on page 1579](#). If this query is sent while not in gate view, the MinFast calculation is performed based on the current values of the appropriate parameters and the result is returned. Knowing this value lets you set an optimal gate delay value for the current measurement setup.

Remote Command	[:SENSe] :SWEep:EGATe:MINFast?
Example	SWE:EGAT:MIN?
Initial S/W Revision	Prior to A.02.00

Gate Preset (Remote Command Only)

Presets the time-gated spectrum analysis capability.

This command sets gate parameter values to the ESA preset values, as follows:

Gate trigger type = edge

Gate polarity = positive

Gate delay = 1 us

Gate length = 1 us

Remote Command	[:SENSe] :SWEep:TIME:GATE:PRESet ESA Compatibility
Initial S/W Revision	Prior to A.02.00

Gate Level (Remote Command Only)

Sets the gate input transition point level for the external TRIGGER inputs on the front and rear panel.

Common Measurement Functions 1

This is a legacy command for PSA compatibility. It is simply an alias to the equivalent trigger level command.

Remote Command	[:SENSe]:SWEep:EGATe:EXTeRnal[1] 2:LEVel <voltage> [:SENSe]:SWEep:EGATe:EXTeRnal[1] 2:LEVel?
Notes	This command is simply an alias to :TRIGger[:SEQuence]:EXTeRnal[1] 2:LEVel For details refer
Initial S/W Revision	Prior to A.02.00

Gate Polarity (Remote Command Only)

Sets the polarity for the gate signal. This setup is now done using the gate trigger's slope setting.

When Positive (Pos) is selected, a positive-going edge (Edge) or a high voltage (Level) will satisfy the gate condition, after the delay set with the Gate Delay key. When Negative (Neg) is selected, a negative-going edge (Edge) or a low voltage (Level) will satisfy the gate condition after the delay.

Key Path	Sweep/Control, Gate
Remote Command	[:SENSe]:SWEep:EGATe:POLarity NEGative POSitive [:SENSe]:SWEep:EGATe:POLarity?
Example	SWE:EGAT:POL NEG SWE:EGAT:POL?
Preset	POSitive
State Saved	Saved in instrument state
Backwards Compatibility SCPI	[:SENSe]:SWEep:TIME:GATE:POLarity ESA compatibility
Initial S/W Revision	Prior to A.02.00

Remote Command	[:SENSe]:SWEep:TIME:GATE:LEVel HIGH LOW [:SENSe]:SWEep:TIME:GATE:LEVel? ESA compatibility
Preset	HIGH
Initial S/W Revision	Prior to A.02.00

Points

Sets the number of points taken per sweep, and displayed in the traces. The current value of points is displayed parenthetically, next to the sweep time in the lower-right corner of the display. Using more points provides greater resolution; using fewer points compacts the data and decreases the time required to access a trace over the remote interface.

Increasing the number of points does not increase the sweep time; however, it can slightly impact the

trace processing time and therefore the overall measurement speed. Decreasing the number of points does not decrease the sweep time, but it may speed up the measurement, depending on the other sweep settings (for example, in FFT sweeps). Fewer points will always speed up the I/O.

Due to minimum sweep rate limitations of the hardware, the minimum sweep time available to the user will increase above its normal value of 1 ms as the number of sweep points increases above 15001.

Changing the number of sweep points has several effects on the analyzer. The sweep time resolution will change. Trace data for all the traces will be cleared and, if Sweep is in Cont, a new trace taken. If any trace is in average or hold, the averaging starts over.

When in a split screen display each window may have its own value for points.

When sweep points is changed, an informational message is displayed, "Sweep points changed, all traces cleared."

Key Path	Sweep/Control
Remote Command	[:SENSe] :SWEep :POINts <integer> [:SENSe] :SWEep :POINts?
Example	SWE:POIN 5001 SWE:POIN?
Dependencies	<ul style="list-style-type: none"> • Neither the knob nor the step keys can be used to change this value. If it is tried, a warning is given. • Clipped to 1001 whenever you are in the Spectrogram View • Grayed out in measurements that do not support swept • Blanked in modes that do not support swept. • Grayed out if Normalize is on; you can't change the number of sweep points with Normalize on, as it will erase the reference trace.
Couplings	<ul style="list-style-type: none"> • When Source Mode is set to Tracking, and Stepped Tracking is used (as with option ESC), 201 source steps are used to achieve optimal speed. The number of sweep points in the analyzer is then set to match the number of steps in the source. When Source Mode is set to Off, the previous number of points (the value that existed when Source Mode was Off previously) is restored, even if the user has changed the Points value while the Source Mode was set to Tracking. • Whenever the number of sweep points change: <ul style="list-style-type: none"> — All trace data is erased — Any traces with Update Off will also go to Display Off (like going from View to Blank in the older analyzers) — Sweep time is re-quantized — Any limit lines that are on will be updated — If averaging/hold is on, averaging/hold starts over
Preset	1001

Common Measurement Functions 1

State Saved	Saved in instrument state
Min	Normally the minimum is 1, but in Tracking Source Mode, the minimum value of Points is 101. If you go into Tracking Source Mode with fewer points than 101, it sets Points to 101.
Max	40001 when not in Tracking Source mode In Tracking Source mode: in Stepped Tracking (e.g., External Source), 1601 or the maximum number of points supported by the source, whichever is less in Swept Tracking (e.g., Tracking Generator), 10000
Backwards Compatibility Notes	In ESA and PSA, Sweep Points was adjustable with the knob and step keys. This caused the sweep time to increase whenever Points was adjusted (either up or down), due to excessive application of the quantization rules. In the X-Series the value of Sweep Points must be entered manually, which avoids this anomaly In ESA the preset value of Sweep Points is 401, in PSA it is 601. In X-Series it is 1001.
Initial S/W Revision	Prior to A.02.00
Modified at S/W Revision	A.02.00

Zoom Points

In the Trace Zoom View of the Swept SA measurement, the Points key changes to Zoom Points whenever the focus (thick green border) is on the bottom window. Zoom Points controls how many points are displayed in the Zoom Window and hence indirectly controls the Zoom Span.

Key Path	Sweep
Remote Command	[:SENSE] :SWEep:TZOom:POINTs <integer> [:SENSE] :SWEep:TZOom:POINTs?
Example	SWE:TZO:POIN 5001
Dependencies	Only appears in the Trace Zoom View of the Swept SA measurement. If the SCPI command is sent in other Views, gives an error.
Couplings	Zoom Points is coupled to Zoom Span and Sweep Points; if Zoom Span changes, Zoom Points will change but Sweep Points will not; if Sweep Points changes, Zoom Points will change but Zoom Span will not. Zoom Span is directly coupled to Zoom Points; if Zoom Points changes, Zoom Span will change but Sweep Points will not.
Preset	On entry to Trace Zoom, 10% of the number of points in the upper window.
State Saved	Saved in instrument state
Min	1
Max	Number of points in top window

Initial S/W Revision	A.07.01
----------------------	---------

Abort (Remote Command Only)

This command is used to stop the current measurement. It aborts the current measurement as quickly as possible, resets the sweep and trigger systems, and puts the measurement into an "idle" state. If the analyzer is in the process of aligning when ABORT is sent, the alignment finishes before the abort function is performed. So ABORT does not abort an alignment.

If the analyzer is set for Continuous measurement, it sets up the measurement and initiates a new data measurement sequence with a new data acquisition (sweep) taken once the trigger condition is met.

If the analyzer is set for Single measurement, it remains in the "idle" state until an :INIT:IMM command is received.

Remote Command	:ABORt
Example	:ABOR
Notes	If :INITiate:CONTinuous is ON, then a new continuous measurement will start immediately; with sweep (data acquisition) occurring once the trigger condition has been met. If :INITiate:CONTinuous is OFF, then :INITiate:IMMediate is used to start a single measurement; with sweep (data acquisition) occurring once the trigger condition has been met.
Dependencies	For continuous measurement, ABORt is equivalent to the Restart key. Not all measurements support the abort command.
Status Bits/OPC dependencies	The STATus:OPERation register bits 0 through 8 are cleared. The STATus:QUEStionable register bit 9 (INTegrity sum) is cleared. Since all the bits that feed into OPC are cleared by the ABORt, the ABORt will cause the *OPC query to return true.
Initial S/W Revision	Prior to A.02.00

Trigger

Accesses a menu of keys to control the selection of the trigger source and the setup of each of the trigger sources. The analyzer is designed to allow triggering from a number of different sources, for example, Free Run, Video, External, RF Burst, and so forth.

The TRIG:SOURCe command (below) will specify the trigger source for the currently selected input (RF or I/Q). If you change inputs, the new input remembers the trigger source it was last programmed to for the current measurement, and uses that trigger source. You can directly set the trigger source for each input using the TRIGger:RF:SOURce and TRIGger:IQ:SOURce commands (later in this section). When in External Mixing, the analyzer uses the RF trigger source.

Note the inclusion of the <measurement> parameter in the command below. Because each measurement remembers its own Trigger Source, the command must be qualified with the measurement name. Note that for the Swept SA measurement this is not the case; for backwards compatibility, no <measurement>

Common Measurement Functions 1

parameter is used when setting the Trigger Source for the Swept SA measurement.

See [“Trigger Source Presets” on page 1597](#)

See [“RF Trigger Source” on page 1601](#)

See [“I/Q Trigger Source” on page 1602](#)

See [“More Information” on page 1603](#)

Key Path	Front-panel key
Remote Command	<p>:TRIGger : <measurement> [:SEquence] :SOURce EXTernal1 EXTernal2 IMMEDIATE LINE FRAME RFBurst VIDEO IF ALARm LAN IQMag IDEMod QDEMod IINPut QINPut AIQMag T V</p> <p>:TRIGger : <measurement> [:SEquence] :SOURce?</p> <p>where <measurement> is the measurement for which you wish to set the Source (blank for the Swept SA measurement)</p>
Example	<p>TRIG:ACP:SOUR EXT1</p> <p>Selects the external 1 trigger input for the ACP measurement and the selected input</p> <p>TRIG:SOUR VID</p> <p>Selects video triggering for the Swept SA (SANalyzer) measurement in the Spectrum Analyzer mode. For SAN, do not use the <measurement> keyword. Only send this form in the Spectrum Analyzer mode or you will get an Undefined Header error</p>
Notes	<p>Not all measurements have all the trigger sources available to them. Check the trigger source documentation for your specific measurement to see what sources are available.</p> <p>Not all trigger sources are available for each input. See the “RF Trigger Source” on page 1601 and “I/Q Trigger Source” on page 1602 commands for detailed information on which trigger sources are available for each input.</p> <p>Other trigger-related commands are found in the INITiate and ABORt SCPI command subsystems.</p> <p>*OPC should be used after requesting data. This will hold off any subsequent changes to the selected trigger source, until after the sweep is completed and the data is returned.</p> <p>Available ranges and presets can vary from mode to mode.</p>
Dependencies	<p>In some models, there is no second External input. In these models, the External 2 key is blanked and the EXTernal2 parameter will generate a “Hardware missing; Not available for this model number” message.</p>
Preset	See table below

Status Bits/OPC dependencies	The Status Operation Register bit 5 "Waiting for Trigger" is set at the same time as the Sweeping or Measuring bit is set. It is cleared when the trigger actually occurs (that is, after the trigger event occurs and all the applicable trigger criteria have been met). A corresponding pop-up message ("Waiting for trigger") is generated if no trigger signal appears after approximately 2 sec. This message goes away when a trigger signal appears.
Backwards Compatibility SCPI	:TRIGger[:SEQuence]:SOURCe EXTernal For backward compatibility, the parameter EXTernal is mapped to EXTernal1
Backwards Compatibility SCPI	[:SENSe] : <measurement> : TRIGger : SOURce This backwards compatibility alias command is provided for ESA/PSA compatibility This backwards compatibility command does not apply to the Swept SA measurement, for that just use :TRIGger:SOURCe This backwards compatibility command does not apply to the monitor spectrum, log plot and spot frequency measurements
Backwards Compatibility SCPI	[:SENSe] : <measurement> : TRIGger : SOURce IF In earlier instruments, the parameter IF was used by apps for the video trigger, so using the IF parameter selects VIDEo triggering. Sending IF in the command causes VID to be returned to a query.
Backwards Compatibility SCPI	[:SENSe]:ACPR:TRIGger:SOURce This backwards Compatibility SCPI command is provided to support the same functionality as [:SENSe]:ACPr:TRIGger:SOURce (PSA W-CDMA, PSA cdma2000 and PSA 1xEVDO) due to the fact that the ACPr node conflicts with the ACPower node.
Initial S/W Revision	Prior to A.02.00
Modified at S/W Revision	A.03.00

Trigger Source Presets

Here are the Trigger Source Presets for the various measurements:

Meas	Mode	Preset for RF	Preset for IQ	Notes
Swept SA	SA	IMM	IQ not supported	

Common Measurement Functions 1

Meas	Mode	Preset for RF	Preset for IQ	Notes
CHP	SA, WCDMA, C2K, WIMAX OFDMA, 1xEVDO, DVB-T/H, DTMB, LTE, LTETDD, CMMB, ISDB-T, Digital Cable TV, MSR	IMM	IQ not supported	
OBW	SA, WCDMA, C2K, WIMAX OFDMA, TD-SCDMA, 1xEVDO, LTE, LTETDD, CMMB, ISDB-T, MSR	1xEVDO: EXT1 others: IMM	IQ not supported	For 1xEVDO mode, the trigger source is coupled with the gate state, as well as the gate source. When the trigger source changes to RFBurst, External1 or External2, the gate state is set to on, and the gate source is set identically with the trigger source. When the trigger source changes to IMMEDIATE, VIDEO, LINE, FRAME or IF, the gate state is set to off.
CCDF	SA, WCDMA, C2K, WIMAX OFDMA, TD-SCDMA, 1xEV-DO, DVB-T/H, DTMB, LTE, LTETDD, CMMB, ISDB-T, Digital Cable TV, MSR	WIMAX OFDMA : RFBurst LTETDD: BTS: External 1 MS: Periodic Timer TD-SCDMA and 1xEV-DO: BTS: External 1 MS: RFBurst SA, WCDMA, C2K, LTE, CMMB, ISDB-T, DVB-T/H, DTMB, Digital Cable TV, MSR: IMMEDIATE	TD-SCDMA and 1xEV-DO: BTS: External 1 MS: IQMag LTETDD: BTS: External 1 MS: Periodic Timer Others: IMM	For TD-SCDMA: Trigger source is coupled with radio device. When radio device changes to BTS, trigger source will be changed to EXTERNAL1. When radio device changes to MS, trigger source will be set as RFBurst for RF or IQ Mag for BBIQ. When TriggerSource is RFBurst or IQ Mag, Measure Interval is grayed out.
ACP	SA, WCDMA, C2K, WIMAX OFDMA, TD-SCDMA, 1xEVDO, DVB-T/H, DTMB, LTE, LTETDD, CMMB, ISDB-T, Digital Cable TV, MSR	IMM	IQ not supported	

Common Measurement Functions 1

Meas	Mode	Preset for RF	Preset for IQ	Notes
Tx Power	SA, GSM, TD-SCDMA	SA, GSM: RFBurst TD-SCDMA: EXTernal	IMM	TD-SCDMA doesn't support the Line and Periodic Timer parameters. When the mode is TD-SCDMA, if the Radio Device is switched to BTS, the value will be changed to External 1 and if the Radio device is switched to MS, the value will be changed to RFBurst
SPUR	SA, WCDMA, C2K, WIMAX OFDMA, TD-SCDMA, 1xE V-DO, DVB-T/H, LTE, LTETDD, MSR	IMM	IQ not supported	
SEM	SA, WCDMA, C2K, WIMAX OFDMA, TD-SCDMA, 1xEVDO, DVB-T/H, DTMB, LTE, LTETDD, CMMB, ISDB-T, Digital Cable TV, MSR	1xEVDO(BTS): EXTernal1 All others: IMMediate	IQ not supported	
CDP	WCDMA	IMM	IMM	
RHO	WCDMA	IMM	IMM	
PCON	WCDMA	IMM	IMM	
QPSK	WCDMA, C2K, 1xEVDO	All except CDMA1xEVDO: IMMediate CDMA1xEVDO: EXT1	IMM	
MON	All except SA and BASIC	IMM	IQ not supported	

Common Measurement Functions 1

Meas	Mode	Preset for RF	Preset for IQ	Notes
WAV		LTETDD: BTS: External 1 MS: Periodic Timer GSM/EDGE: RFBurst All others: IMMEDIATE	LTETDD: BTS: External 1 MS: Periodic Timer GSM/EDGE: IQMag All others: IMMEDIATE	
PVT	WIMAXOFDMA	RFB	IMM	
EVM	WIMAXOFDMA , DVB-T/H, DTMB, LTE, LTETDD, CMMB, ISDB-T, Digital Cable TV	All but CMMB: IMM CMMB: Periodic Timer	All but CMMB: IMM CMMB: External 1	LTE, LTETDD supports Free Run, Video and External 1 only.
SPEC	BASIC	IMM	IMM	
LOG Plot	PN	IMM	IQ not supported	
Spot Freq	PN	IMM	IQ not supported	
GMSK PVT	EDGE/GSM	RFB	IMM	
GMSK PFER	EDGE/GSM	RFB	IQMag	
GMSK ORFS	EDGE/GSM	RF Burst	IQ not supported	
EDGE PVT	EDGE/GSM	RFB	IMM	
EDGE EVM	EDGE/GSM	RFB	IQMag	
EDGE ORFS	EDGE/GSM	Periodic Timer	IQ not supported	
Combined WCDMA	WCDMA	IMM	IQ not supported	
Combined GSM	EDGE/GSM	RFB	IQ not supported	
List Power Step	WCDMA, EDGE/GSM	IMM	IQ not supported	

Meas	Mode	Preset for RF	Preset for IQ	Notes
Transmit On/Off Power	LTETDD	LTETDD: BTS: External 1 MS: Periodic Timer	LTETDD: BTS: External 1 MS: Periodic Timer	
Transmit Analysis	BLUETOOTH	RFB	IQ not supported	
Adjacent Channel Power	BLUETOOTH	IMM	IQ not supported	
LE In-band Emissions	BLUETOOTH	IMM	IQ not supported	
EDR In-band Spurious Emissions	BLUETOOTH	Periodic Timer	IQ not supported	
Conformance EVM	LTE, LTETDD, MSR	IMM	IMM	

RF Trigger Source

The **RF Trigger Source** command selects the trigger to be used for the specified measurement when RF is the selected input. The RF trigger source can be queried and changed even while another input is selected, but it is inactive until RF becomes the selected input.

Note the inclusion of the <measurement> parameter in the command below. Because each measurement remembers its own Trigger Source, the command must be qualified with the measurement name. Note that for the Swept SA measurement this is not the case; for backwards compatibility, no <measurement> parameter is used when setting the Trigger Source for the Swept SA measurement.

Remote Command	<pre>:TRIGger:<measurement>[:SEquence]:RF:SOURce EXTernal1 EXTernal2 IMMEDIATE LINE FRAME RFBurst VIDeo IF ALARm LAN TV :TRIGger:<measurement>[:SEquence]:RF:SOURce?</pre>
Example	<pre>TRIG:ACP:RF:SOUR EXT1</pre> <p>Selects the external 1 trigger input for the ACP measurement and the RF input</p> <pre>TRIG:RF:SOUR VID</pre> <p>Selects video triggering for the SANalyzer measurement and the RF input. For SAN, do not use the <measurement> keyword.</p>

Common Measurement Functions 1

Notes	<p>Not all measurements have all the trigger sources available to them. Check the trigger source documentation for your specific measurement to see what sources are available.</p> <p>Not all trigger sources are available for each input. For the RF Trigger Source, the following trigger sources are available:</p> <ul style="list-style-type: none"> — IMMEDIATE - free run triggering — VIDEO - triggers on the video signal level — LINE - triggers on the power line signal — EXTERNAL1 (or EXTERNAL) - triggers on an externally connected trigger source marked "Trigger 1 In" on the rear panel — EXTERNAL2 - triggers on an externally connected trigger source marked "Trigger 2 In" on the front panel. In some models, there is no second External input. In these models, the External 2 key is blanked and the EXTERNAL2 parameter will generate a "Hardware missing; Not available for this model number" message — RFBURST - triggers on the bursted frame — FRAME - triggers on the periodic timer — IF (video) - same as video, for backwards compatibility only <p>*OPC should be used after requesting data. This will hold off any subsequent changes to the selected trigger source, until after the sweep is completed and the data is returned.</p> <p>Available ranges, and presets can vary from mode to mode.</p>
Status Bits/OPC dependencies	<p>The Status Operation Register bit 5 "Waiting for Trigger" is set at the same time as the Sweeping or Measuring bit is set. It is cleared when the trigger actually occurs (that is, after the trigger event occurs and all the applicable trigger criteria have been met). A corresponding pop-up message ("Waiting for trigger") is generated if no trigger signal appears after approximately 2 sec. This message goes away when a trigger signal appears.</p>
Initial S/W Revision	Prior to A.02.00

I/Q Trigger Source

This command selects the trigger to be used for the specified measurement when I/Q (which requires option BBA) is the selected input. The I/Q trigger source can be queried and changed even while another input is selected, but it is inactive until I/Q becomes the selected input.

Remote Command	<pre>:TRIGger:<measurement>[:SEQUENCE]:IQ:SOURce EXTernal1 EXTernal2 IMMediate IQMag IDEMod QDEMod IINPu t QINPut AIQMag :TRIGger:<measurement>[:SEQUENCE]:IQ:SOURce?</pre>
Example	<pre>TRIG:WAVEform:SOUR IQM</pre> <p>Selects I/Q magnitude triggering for the IQ Waveform measurement and the I/Q input</p>

Notes	<p>Not all measurements have all the trigger sources available to them. Check the trigger source documentation for your specific measurement to see what sources are available.</p> <p>Not all trigger sources are available for each input. For the I/Q Trigger Source, the following trigger sources are available:</p> <ul style="list-style-type: none"> — IMMEDIATE - free run triggering — EXTERNAL1 (or EXTERNAL) - triggers on an externally connected trigger source on the rear panel — EXTERNAL2 - triggers on an externally connected trigger source on the front panel — IQMAG - triggers on the magnitude of the I/Q signal — IDEMOD - triggers on the I/Q signal's demodulated I voltage — QDEMOD - triggers on the I/Q signal's demodulated Q voltage — IINPUT - triggers on the I channel's ADC voltage — QINPUT - triggers on the Q channel's ADC voltage — AIQMAG - triggers on the magnitude of the auxiliary receiver channel I/Q signal <p>*OPC should be used after requesting data. This will hold off any subsequent changes to the selected trigger source, until after the sweep is completed and the data is returned.</p> <p>Available ranges, and from mode to mode presets can vary</p>
Status Bits/OPC dependencies	<p>The Status Operation Register bit 5 "Waiting for Trigger" is set at the same time as the Sweeping or Measuring bit is set. It is cleared when the trigger actually occurs (that is, after the trigger event occurs and all the applicable trigger criteria have been met). A corresponding pop-up message ("Waiting for trigger") is generated if no trigger signal appears after approximately 2 sec. This message goes away when a trigger signal appears.</p>
Initial S/W Revision	Prior to A.02.00

More Information

The trigger menus let you select the trigger source and trigger settings for a sweep or measurement. In triggered operation (basically, any trigger source other than Free Run), the analyzer will begin a sweep or measurement only with the selected trigger conditions are met, generally when your trigger source signal meets the specified trigger level and polarity requirements. (In FFT measurements, the trigger controls when the data acquisition begins for FFT conversion.)

For each of the trigger sources, you may define a set of operational parameters or settings which will be applied when that source is selected as the current trigger source. Examples of these settings are Trigger Level, Trigger Delay, and Trigger Slope. You may apply different settings for each source; so, for example, you could have a Trigger Level of 1v for External 1 trigger and -10 dBm for Video trigger.

Once you have established the settings for a given trigger source, they generally will remain unchanged for that trigger source as you go from measurement to measurement within a Mode (although the settings do change as you go from Mode to Mode). Furthermore, the trigger settings within a Mode are the same

State Saved	Saved in instrument state
Status Bits/OPC dependencies	The Status Operation Register bit 5 "Waiting for Trigger" is set at the same time as the Sweeping or Measuring bit is set. It is cleared when the trigger actually occurs (that is, after the trigger event occurs and all the applicable trigger criteria have been met). A corresponding pop-up message ("Waiting for trigger") is generated if no trigger signal appears after approximately 2 sec. This message goes away when a trigger signal appears.
Initial S/W Revision	Prior to A.02.00

Video (IF Envelope)

Pressing this key, when it is not selected, selects the video signal as the trigger. The Video trigger condition is met when the video signal (the filtered and detected version of the input signal, including both RBW and VBW filtering) crosses the video trigger level.

NOTE When the detector selected for all active traces is the average detector, the video signal for triggering does not include any VBW filtering.

The video trigger level is shown as a labeled line on the display. The line is displayed as long as video is the selected trigger source.

Pressing this key, when it is already selected, accesses the video trigger setup functions.

Key Path	Trigger
Example	TRIG:SOUR VID Swept SA measurement TRIG:<meas>:SOUR VID Measurements other than Swept SA
Notes	Log Plot and Spot Frequency measurements do not support Video Trigger
Dependencies	Video trigger is allowed in average detector mode.
State Saved	Saved in instrument state
Status Bits/OPC dependencies	The Status Operation Register bit 5 "Waiting for Trigger" is set at the same time as the Sweeping or Measuring bit is set. It is cleared when the trigger actually occurs (that is, after the trigger event occurs and all the applicable trigger criteria have been met). A corresponding pop-up message ("Waiting for trigger") is generated if no trigger signal appears after approximately 2 sec. This message goes away when a trigger signal appears.
Backwards Compatibility Notes	In the past, the Average detector was not available when Video triggering was on, and consequently, functions that set the detector to average (such as Marker Noise or Band/Intvl Power) were not available when the video trigger was on. Similarly, Video triggering was not available when the detector was Average. In the X-Series, these restrictions are removed.
Initial S/W Revision	Prior to A.02.00

Trigger Level

Sets a level for the video signal trigger. When the video signal crosses this level, with the chosen slope,

Common Measurement Functions 1

the trigger occurs. This level is displayed with a horizontal line only if **Video** is the selected trigger source.

Key Path	Trigger, Video
Remote Command	:TRIGger[:SEquence]:VIDeo:LEVel <amp1> :TRIGger[:SEquence]:VIDeo:LEVel?
Example	TRIG:VID:LEV -40 dBm
Notes	<p>When sweep type = FFT, the video trigger uses the amplitude envelope in a bandwidth wider than the FFT width as a trigger source. This might often be useful, but does not have the same relationship between the displayed trace and the trigger level as in swept triggering.</p> <p>Amplitude Corrections are not taken into account by the Video Trig Level. For example, if you have given yourself effective gain with an amplitude correction factor, the Video Trigger will not fire until you have dropped the trigger line that far below the displayed signal level, rather than simply dropping it down to the displayed signal level.</p> <p>Note that other corrections, specifically External Gain and Ref Level Offset, modify the actual trace data as it is taken and therefore ARE taken into account by Trig Level.</p>
Couplings	This same level is used for the Video trigger source in the Trigger menu and for the Video selection in the Gate Source menu.
Preset	Set the Video Trigger Level -25 dBm on Preset. When the Video Trigger Level becomes the active function, if the value is off screen, set it to either the top or bottom of screen, depending on which direction off screen it was.
State Saved	Saved in instrument state
Min	-170 dBm
Max	+30 dBm
Default Unit	depends on the current selected Y axis unit
Backwards Compatibility SCPI	:TRIGger[:SEquence]:IF:LEVel :TRIGger[:SEquence]:IF:LEVel?
Backwards Compatibility Notes	This alias is provided for backward compatibility with VSA/PSA comms apps.
Initial S/W Revision	Prior to A.02.00

Trig Slope

Controls the trigger polarity. It is set positive to trigger on a rising edge and negative to trigger on a falling edge.

Key Path	Trigger, Video
----------	----------------

Remote Command	:TRIGger[:SEquence]:VIDeo:SLOPe POSitive NEGative :TRIGger[:SEquence]:VIDeo:SLOPe?
Example	TRIG:VID:SLOP NEG
Preset	POSitive
State Saved	Saved in instrument state
Backwards Compatibility SCPI	:TRIGger[:SEquence]:IF:SLOPe NEGative POSitive :TRIGger[:SEquence]:IF:SLOPe? For backward compatibility with VSA/PSA comms apps
Backwards Compatibility Notes	The legacy :TRIGger[:SEquence]:SLOPe command affects the slopes for the VID, LINE, EXT1, EXT2, and RFB triggers.
Initial S/W Revision	Prior to A.02.00

Remote Command	:TRIGger[:SEquence]:SLOPe POSitive NEGative :TRIGger[:SEquence]:SLOPe?
Example	TRIG:SLOP NEG
Preset	POSitive
State Saved	Saved in instrument state
Backwards Compatibility Notes	In ESA/PSA, the Trigger Slope was global to all triggers. In the X-Series, the slope can be set individually for each Trigger Source. For backward compatibility, the global SLOPe command updates all instances of trigger slope (VID, LINE, EXT1, EXT2, TV, RFB). The query returns the trigger slope setting of the currently selected trigger source.
Initial S/W Revision	Prior to A.02.00

Trig Delay

Controls a time delay during that the analyzer will wait to begin a sweep after meeting the trigger criteria. You can use negative delay to pre-trigger the instrument in the time domain or FFT, but not in swept spans.

Key Path	Trigger, Video
Remote Command	:TRIGger[:SEquence]:VIDeo:DELAy <time> :TRIGger[:SEquence]:VIDeo:DELAy? :TRIGger[:SEquence]:VIDeo:DELAy:STATe OFF ON 0 1 :TRIGger[:SEquence]:VIDeo:DELAy:STATe?
Example	TRIG:VID:DEL:STAT ON TRIG:VID:DEL 100 ms

Common Measurement Functions 1

Notes	Video trigger delay may be set to negative values, in time domain, FFT and even swept. It makes intuitive sense in time domain and works well in FFT mode where the bandwidth of the filter before the video trigger is about 1.25 span. In swept spans, negative settings of Trig Delay are treated as a zero setting within the internal hardware and the advisory message "Neg. Trig Delay unavailable in Swept Mode, zero delay used." is generated when such a delay is set.
Preset	Off, 1 us
State Saved	Saved in instrument state
Min	-150 ms
Max	+500 ms
Default Unit	s
Backwards Compatibility SCPI	:TRIGger[:SEquence]:IF:DELay :TRIGger[:SEquence]:DELay For backward compatibility with VSA/PSA comms apps
Initial S/W Revision	Prior to A.02.00

Remote Command	:TRIGger[:SEquence]:DELay <time> :TRIGger[:SEquence]:DELay? :TRIGger[:SEquence]:DELay:STATE OFF ON 0 1 :TRIGger[:SEquence]:DELay:STATE?
Example	TRIG:DEL 1 ms
Preset	1 us
State Saved	Saved in instrument state
Backwards Compatibility Notes	In ESA/PSA, the Trigger Delay was global to all triggers. In the X-Series, the delay can be set individually for each Trigger Source. For backward compatibility, the global DELay command updates all instances of trigger slope (VID, LINE, EXT1, EXT2) except TV and RFBurst. The query returns the trigger delay setting of the currently selected trigger source.
Initial S/W Revision	Prior to A.02.00

Remote Command	:TRIGger[:SEquence]:OFFSet <time> :TRIGger[:SEquence]:OFFSet? :TRIGger[:SEquence]:OFFSet:STATE OFF ON 0 1 :TRIGger[:SEquence]:OFFSet:STATE?
Example	TRIG:OFFS ON TRIG:OFFS -100 ms

Notes	These are ESA commands for trigger offset that allowed you to use a positive or negative delay when in zero span and in a Res BW \geq 1 kHz. For ESA compatibility, X-series analyzers keep track of this offset and adds it to the Trigger Delay for VIDEo, LINE, EXTERNAL1 or EXTERNAL2 whenever the value is sent to the hardware, if in Zero Span and RBW \geq 1 kHz.
Preset	Off, 0 s
State Saved	Saved in instrument state
Min	-11 s
Max	+11 s
Initial S/W Revision	Prior to A.02.00

Line

Pressing this key, when it is not selected, selects the line signal as the trigger. A new sweep/measurement will start synchronized with the next cycle of the line voltage. Pressing this key, when it is already selected, access the line trigger setup menu.

Key Path	Trigger
Example	TRIG:SOUR LINE Swept SA measurement TRIG:<meas>:SOUR LINE Measurements other than Swept SA
Dependencies	Line trigger is not available when operating from a "dc power source", for example, when the instrument is powered from batteries.
State Saved	Saved in instrument state
Status Bits/OPC dependencies	The Status Operation Register bit 5 "Waiting for Trigger" is set at the same time as the Sweeping or Measuring bit is set. It is cleared when the trigger actually occurs (that is, after the trigger event occurs and all the applicable trigger criteria have been met). A corresponding pop-up message ("Waiting for trigger") is generated if no trigger signal appears after approximately 2 sec. This message goes away when a trigger signal appears.
Initial S/W Revision	Prior to A.02.00

Trig Slope

Controls the trigger polarity. It is set positive to trigger on a rising edge and negative to trigger on a falling edge.

Key Path	Trigger, Line
Remote Command	:TRIGger[:SEquence]:LINE:SLOPe POSitive NEGative :TRIGger[:SEquence]:LINE:SLOPe?

Common Measurement Functions 1

Example	TRIG:LINE:SLOP NEG
Preset	POSitive
State Saved	Saved in instrument state
Backwards Compatibility Notes	The legacy :TRIGger[:SEQuence]:SLOPe command affects the slopes for the VID, LINE, EXT1, EXT2, and RFB triggers.
Initial S/W Revision	Prior to A.02.00

Trig Delay

Controls a time delay during which the analyzer will wait to begin a sweep after meeting the trigger criteria. You can use negative delay to pre-trigger the instrument in time domain or FFT, but not in swept spans.

Key Path	Trigger, Line
Remote Command	:TRIGger[:SEQuence]:LINE:DELay <time> :TRIGger[:SEQuence]:LINE:DELay? :TRIGger[:SEQuence]:LINE:DELay:STATe OFF ON 0 1 :TRIGger[:SEQuence]:LINE:DELay:STATe?
Example	TRIG:LINE:DEL:STAT ON TRIG:LINE:DEL 100 ms
Notes	Video trigger delay may be set to negative values, in time domain, FFT and even swept. It makes intuitive sense in time domain and works well in FFT mode where the bandwidth of the filter before the video trigger is about 1.25 span. In swept spans, negative settings of Trig Delay are treated as a zero setting within the internal hardware and the advisory message "Neg. Trig Delay unavailable in Swept Mode, zero delay used." is generated when such a delay is set.
Preset	Off, 1.000 us
State Saved	Saved in instrument state
Min	-150 ms
Max	500 ms
Default Unit	S
Backwards Compatibility Notes	The legacy :TRIGger[:SEQuence]:DELay command affects the delay for the VID, LINE, EXT1, and EXT2 triggers. The legacy :TRIGger[:SEQuence]:OFFSet command is supported for the VIDEo, LINE, EXT1, and EXT2 triggers.
Initial S/W Revision	Prior to A.02.00

External 1

Pressing this key, when it is not selected, selects an external input signal as the trigger. A new sweep/measurement will start when the external trigger condition is met using the external 1 input connector on the rear panel.

Pressing this key, when it is already selected, accesses the external 1 trigger setup menu.

Key Path	Trigger
Example	TRIG:SOUR EXT1 Swept SA measurement TRIG:<meas>:SOUR EXT1 Measurements other than Swept SA
Dependencies	Grayed out if in use by Point Trigger in the Source Setup menu. Forced to Free Run if already selected and Point Trigger is set to External 1.
State Saved	Saved in instrument state
Status Bits/OPC dependencies	The Status Operation Register bit 5 "Waiting for Trigger" is set at the same time as the Sweeping or Measuring bit is set. It is cleared when the trigger actually occurs (that is, after the trigger event occurs and all the applicable trigger criteria have been met). A corresponding pop-up message ("Waiting for trigger") is generated if no trigger signal appears after approximately 2 sec. This message goes away when a trigger signal appears.
Initial S/W Revision	Prior to A.02.00

Trigger Level

Sets the value where the external 1 trigger input will trigger a new sweep/measurement.

Key Path	Trigger, External 1
Remote Command	:TRIGger[:SEQuence]:EXTernal1:LEVel <level> :TRIGger[:SEQuence]:EXTernal1:LEVel?
Example	TRIG:EXT1:LEV 0.4 V
Couplings	This same level is used for the Ext1 trigger source in the Trigger menu, for the Ext1 selection in the Periodic Timer sync source (in the Trigger menu and in the Gate Source menu), and also for the Ext1 selection in the Gate Source menu.
Preset	1.2 V
State Saved	Saved in instrument state
Min	-5 V
Max	5 V
Default Unit	V
Backwards Compatibility SCPI	:TRIGger[:SEQuence]:EXTernal:LEVel For backward compatibility, the parameter EXTernal is mapped to EXTernal1

Common Measurement Functions 1

Backwards Compatibility SCPI	:TRIGger[:SEQuence]:FRAMe:EXTErnal1:LEVel
Initial S/W Revision	Prior to A.02.00

Trig Slope

Controls the trigger polarity. It is set positive to trigger on a rising edge and negative to trigger on a falling edge.

Key Path	Trigger, External 1
Remote Command	:TRIGger[:SEQuence]:EXTErnal1:SLOPe POSitive NEGative :TRIGger[:SEQuence]:EXTErnal1:SLOPe?
Example	TRIG:EXT1:SLOP NEG
Couplings	This same slope is used in the Ext1 selection for the trigger source in the Trigger menu and for the period timer sync source (in the Trigger menu and in the Gate Source menu).
Preset	POSitive
State Saved	Saved in instrument state
Backwards Compatibility SCPI	:TRIGger[:SEQuence]:EXTErnal:SLOPe For backward compatibility, the parameter EXTErnal is mapped to EXTErnal1
Backwards Compatibility SCPI	:TRIGger[:SEQuence]:FRAMe:EXTErnal1:SLOPe
Backwards Compatibility Notes	The legacy :TRIGger[:SEQuence]:SLOPe command affects the slopes for the VID, LINE, EXT1, EXT2, and RFB triggers.
Initial S/W Revision	Prior to A.02.00

Trig Delay

Controls a time delay during which the analyzer will wait to begin a sweep after meeting the trigger criteria. You can use negative delay to pre-trigger the instrument in time domain or FFT, but not in swept spans.

Key Path	Trigger, External 1
Remote Command	:TRIGger[:SEQuence]:EXTErnal1:DELAy <time> :TRIGger[:SEQuence]:EXTErnal1:DELAy? :TRIGger[:SEQuence]:EXTErnal1:DELAy:STATe OFF ON 0 1 :TRIGger[:SEQuence]:EXTErnal1:DELAy:STATe?
Example	TRIG:EXT1:DEL:STAT ON TRIG:EXT1:DEL 100 ms

Notes	Video trigger delay may be set to negative values, in time domain, FFT and even swept. It makes intuitive sense in time domain and works well in FFT mode where the bandwidth of the filter before the video trigger is about 1.25 span. In swept spans, negative settings of Trig Delay are treated as a zero setting within the internal hardware and the advisory message "Neg. Trig Delay unavailable in Swept Mode, zero delay used." is generated when such a delay is set.
Preset	Off, 1.000 us
State Saved	Saved in instrument state
Min	-150 ms
Max	+500 ms
Default Unit	s
Backwards Compatibility SCPI	:TRIGger[:SEQuence]:EXTErnal:DELay For backward compatibility, the parameter EXTErnal is mapped to EXTErnal1
Backwards Compatibility Notes	The legacy :TRIGger[:SEQuence]:DELay command affects the delay for the VID, LINE, EXT1, and EXT2 triggers. The legacy :TRIGger[:SEQuence]:OFFSet command is supported for the VIDEo, LINE, EXT1, and EXT2 triggers.
Initial S/W Revision	Prior to A.02.00

External 2

Pressing this key, when it is not selected, selects an external input signal as the trigger. A new sweep/measurement will start when the external trigger condition is met using the external 2 input connector. The external trigger 2 input connector is on the rear panel.

Pressing this key, when it is already selected, accesses the external 2 trigger setup menu.

Key Path	Trigger
Example	TRIG:SOUR EXT2 Swept SA measurement TRIG:<meas>:SOUR EXT2 Measurements other than Swept SA
Dependencies	In some models, there is no second External input. In these models, the External 2 key is blanked and the EXTErnal2 parameter will generate a "Hardware missing; Not available for this model number" message. Grayed out if in use by Point Trigger in the Source Setup menu. Forced to Free Run if already selected and Point Trigger is set to External 2.
State Saved	Saved in instrument state

Common Measurement Functions 1

Status Bits/OPC dependencies	The Status Operation Register bit 5 "Waiting for Trigger" is set at the same time as the Sweeping or Measuring bit is set. It is cleared when the trigger actually occurs (that is, after the trigger event occurs and all the applicable trigger criteria have been met). A corresponding pop-up message ("Waiting for trigger") is generated if no trigger signal appears after approximately 2 sec. This message goes away when a trigger signal appears.
Initial S/W Revision	Prior to A.02.00
Modified at S/W Revision	A.03.00

Trigger Level

Sets the value where the external 2 trigger input will trigger a new sweep/measurement.

Key Path	Trigger, External 2
Remote Command	:TRIGger[:SEquence]:EXTernal2:LEVel :TRIGger[:SEquence]:EXTernal2:LEVel?
Example	TRIG:EXT2:LEV 1.1 V
Couplings	This same level is used for the Ext2 trigger source in the Trigger menu, for the Ext2 selection in the Periodic Timer sync source (in the Trigger menu and in the Gate Source menu), and also for the Ext2 selection in the Gate Source menu.
Preset	1.2 V
State Saved	Saved in instrument state
Min	-5 V
Max	5 V
Default Unit	V
Backwards Compatibility SCPI	:TRIGger[:SEquence]:FRAMe:EXTernal2:LEVel
Initial S/W Revision	Prior to A.02.00

Trig Slope

Controls the trigger polarity. It is set positive to trigger on a rising edge and negative to trigger on a falling edge.

Key Path	Trigger, External 2
Remote Command	:TRIGger[:SEquence]:EXTernal2:SLOPe POSitive NEGative :TRIGger[:SEquence]:EXTernal2:SLOPe?
Example	TRIG:EXT2:SLOP NEG
Couplings	This same slope is used in the Ext2 selection for the trigger source in the Trigger menu and for the period timer sync source (in the Trigger menu and in the Gate Source menu).

Preset	POSitive
State Saved	Saved in instrument state
Backwards Compatibility SCPI	:TRIGger[:SEQuence]:FRAMe:EXTeRnal2:SLOPe
Backwards Compatibility Notes	The legacy :TRIGger[:SEQuence]:SLOPe command affects the slopes for the VID, LINE, EXT1, EXT2, and RFB triggers.
Initial S/W Revision	Prior to A.02.00

Trig Delay

Controls a time delay during which the analyzer will wait to begin a sweep after meeting the trigger criteria. You can use negative delay to pre-trigger the instrument in time domain or FFT, but not in swept spans.

Key Path	Trigger, External 2
Remote Command	:TRIGger[:SEQuence]:EXTeRnal2:DELAy <time> :TRIGger[:SEQuence]:EXTeRnal2:DELAy? :TRIGger[:SEQuence]:EXTeRnal2:DELAy:STATe OFF ON 0 1 :TRIGger[:SEQuence]:EXTeRnal2:DELAy:STATe?
Example	TRIG:EXT2:DEL:STAT ON TRIG:EXT2:DEL 100 ms
Notes	Video trigger delay may be set to negative values, in time domain, FFT and even swept. It makes intuitive sense in time domain and works well in FFT mode where the bandwidth of the filter before the video trigger is about 1.25 span. In swept spans, negative settings of Trig Delay are treated as a zero setting within the internal hardware and the advisory message "Neg. Trig Delay unavailable in Swept Mode, zero delay used." is generated when such a delay is set.
Preset	Off, 1.000 us
State Saved	Saved in instrument state
Min	-150 ms
Max	500 ms
Default Unit	s
Backwards Compatibility Notes	The legacy :TRIGger[:SEQuence]:DELAy command affects the delay for the VID, LINE, EXT1, and EXT2 triggers. The legacy :TRIGger[:SEQuence]:OFFSet command is supported for the VIDEo, LINE, EXT1, and EXT2 triggers.
Initial S/W Revision	Prior to A.02.00

Common Measurement Functions 1

RF Burst

Pressing this key, when it is not selected, selects the RF Burst as the trigger. A new sweep/measurement will start when an RF burst envelope signal is identified from the signal at the RF Input connector. Pressing this key, when it is already selected, accesses the RF Burst trigger setup menu.

In some models, a variety of burst trigger circuitry is available, resulting in various available burst trigger bandwidths. The analyzer automatically chooses the appropriate trigger path based on the hardware configuration and other settings of the analyzer.

Key Path	Trigger
Example	TRIG:SOUR RFB Swept SA measurement TRIG:<meas>:SOUR RFB Measurements other than Swept SA
State Saved	Saved in instrument state
Status Bits/OPC dependencies	The Status Operation Register bit 5 "Waiting for Trigger" is set at the same time as the Sweeping or Measuring bit is set. It is cleared when the trigger actually occurs (that is, after the trigger event occurs and all the applicable trigger criteria have been met). A corresponding pop-up message ("Waiting for trigger") is generated if no trigger signal appears after approximately 2 sec. This message goes away when a trigger signal appears.
Backwards Compatibility Notes	<ol style="list-style-type: none"> 1. The legacy command: 2. :TRIGger[:SEquence]:RFBurst:FSElectivity[:STATe] OFF ON 0 1 3. is not supported in the X-Series, as the hardware to do Frequency Selective burst triggers does not exist in X-Series.
Initial S/W Revision	Prior to A.02.00
Modified at S/W Revision	A.04.00

Absolute Trigger Level

Sets the absolute trigger level for the RF burst envelope.

When using the External Mixing path, the Absolute Trigger Level is uncalibrated because the factory default was set to accommodate the expected IF levels for the RF path.

Key Path	Trigger, RF Burst
Scope	Meas Global
Remote Command	:TRIGger[:SEquence]:RFBurst:LEVel:ABSolute <ampl> :TRIGger[:SEquence]:RFBurst:LEVel:ABSolute?
Example	TRIG:RFB:LEV:ABS 10 dBm sets the trigger level of the RF burst envelope signal to the absolute level of 10 dBm

Notes	<p>Sending this command does not switch the setting from relative to absolute; to switch it you need to send the :TRIGger[:SEQuence]:RFBurst:LEVel:TYPE command, below.</p> <p>Amplitude Corrections are not taken into account by the Absolute Trigger Level. For example, if you have given yourself effective gain with an amplitude correction factor, the Absolute Trigger will not fire until you have set the trigger level that far below the displayed signal level, rather than simply to the displayed signal level. This is only true for Amplitude Corrections, not External Gain or Ref Level Offset functions.</p> <p>If mode is Bluetooth, the default value is -50 dBm.</p>
Couplings	This same level is used for the RF Burst trigger source in the Trigger menu, for the RF Burst selection in the Periodic Timer sync source (in the Trigger menu and in the Gate Source menu), and also for the RF Burst selection in the Gate Source menu
Preset	-20 dBm
State Saved	Saved in state
Min	-200 dBm
Max	100 dBm
Default Unit	depends on the current selected Y-Axis unit
Backwards Compatibility SCPI	:TRIGger[:SEQuence]:FRAME:RFBurst:LEVel:ABSolute
Initial S/W Revision	Prior to A.02.00
Modified at S/W Revision	A.04.00

Key Path	Trigger, RF Burst
Remote Command	:TRIGger[:SEQuence]:RFBurst:LEVel:TYPE ABSolute RELative :TRIGger[:SEQuence]:RFBurst:LEVel:TYPE?
Example	TRIG:RFB:LEV:TYPE REL sets the trigger level type of the RF burst trigger to Relative.
Preset	ABSolute
State Saved	Saved in instrument state
Initial S/W Revision	Prior to A.02.00
Modified at S/W Revision	A.04.00

Relative Trigger Level

Sets the relative trigger level for the RF burst envelope.

In some models, the relative burst trigger function is implemented in hardware. In other models, without the advanced triggering hardware required, the relative burst trigger function is implemented in software

Common Measurement Functions 1

in some measurements, and is unavailable in other measurements.

When implemented in software, the relative RF Burst trigger function is implemented as follows:

The measurement starts with the absolute RF Burst trigger setting. If it cannot get a trigger with that level, auto trigger fires and the acquisition starts anyway. After the acquisition, the measurement searches for the peak in the acquired waveform and saves it.

Now, in the next cycle of the measurement, the measurement determines a new absolute RF Burst level based on the peak value from the first measurement and the Relative RF Burst Trigger Level (always 0 or negative dB) set by the user. The following formula is used:

absolute RF Burst level = peak level of the previous acquisition + relative RF Burst level

If the new absolute RF Burst level differs from the previous by more than 0.5 dB, the new level is sent to the hardware; otherwise it is not updated (to avoid slowing down the acquisition)

Steps 2 and 3 repeat for subsequent measurements.

Key Path	Trigger, RF Burst
Scope	Meas Global
Remote Command	:TRIGger[:SEquence]:RFBurst:LEVel:RELative <rel_ampl> :TRIGger[:SEquence]:RFBurst:LEVel:RELative?
Example	TRIG:RFB:LEV:REL -10 dB sets the trigger level of the RF burst envelope signal to the relative level of -10 dB
Notes	Sending this command does not switch the setting from absolute to relative; to switch it you need to send the :TRIGger[:SEquence]:RFBurst:LEVel:TYPE command, above. The relative trigger level is not available in some measurements. In those measurements the RELative parameter, and the :TRIGger[:SEquence]:RFBurst:LEVel:TYPE command (above), will generate an error if sent.
Dependencies	This key is grayed out and Absolute Trigger Level selected if the required hardware is not present in your analyzer and the current measurement does not support Relative triggering.
Preset	-6 dB GSM: -25 dB
State Saved	Saved in instrument state
Min	-45 dB
Max	0 dB
Default Unit	dB or dBc

Backwards Compatibility SCPI	:TRIGger[:SEQuence]:RFBurst:LEVel This legacy command is aliased to :TRIGger[:SEQuence]:RFBurst:LEVel:RELative because the PSA had ONLY relative burst triggering
Initial S/W Revision	Prior to A.02.00
Modified at S/W Revision	A.04.00

Trigger Slope

It is set positive to trigger on a rising edge and negative to trigger on a falling edge.

Key Path	Trigger, RF Burst
Remote Command	:TRIGger[:SEQuence]:RFBurst:SLOPe POSitive NEGative :TRIGger[:SEQuence]:RFBurst:SLOPe?
Example	TRIG:RFB:SLOP NEG
Couplings	This same slope is used in the RF Burst selection for the trigger source in the Trigger menu and for the period timer sync source (in the Trigger menu and in the Gate Source menu).
Preset	POSitive
State Saved	Saved in instrument state
Backwards Compatibility SCPI	:TRIGger[:SEQuence]:FRAME:RFBurst:SLOPe
Backwards Compatibility Notes	The legacy :TRIGger[:SEQuence]:SLOPe command affects the slopes for the VID, LINE, EXT1, EXT2, and RFB triggers.
Initial S/W Revision	Prior to A.02.00

Trig Delay

Controls a time delay during which the analyzer will wait to begin a sweep after meeting the trigger criteria. You can use negative delay to pre-trigger the instrument in time domain or FFT, but not in swept spans.

Key Path	Trigger, RF Burst
Remote Command	:TRIGger[:SEQuence]:RFBurst:DELaY <time> :TRIGger[:SEQuence]:RFBurst:DELaY? :TRIGger[:SEQuence]:RFBurst:DELaY:STATe OFF ON 0 1 :TRIGger[:SEQuence]:RFBurst:DELaY:STATe?
Example	TRIG:RFB:DEL:STAT ON TRIG:RFB:DEL 100 ms

Common Measurement Functions 1

Notes	Video trigger delay may be set to negative values, in time domain, FFT and even swept. It makes intuitive sense in time domain and works well in FFT mode where the bandwidth of the filter before the video trigger is about 1.25 span. In swept spans, negative settings of Trig Delay are treated as a zero setting within the internal hardware and the advisory message "Neg. Trig Delay unavailable in Swept Mode, zero delay used." is generated when such a delay is set.
Preset	Off, 1.000 us
State Saved	Saved in instrument state
Min	-150 ms
Max	500 ms
Default Unit	s
Initial S/W Revision	Prior to A.02.00

Periodic Timer (Frame Trigger)

Pressing this key, when it is not selected, selects the internal periodic timer signal as the trigger. Triggering occurrences are set by the **Period** parameter, which is modified by the **Sync Source** and **Offset**. Pressing this key, when it is already selected, accesses the periodic timer trigger setup functions.

If you do not have a sync source selected (it is Off), then the internal timer will not be synchronized with any external timing events.

Key Path	Trigger
Example	TRIG:SOUR FRAM Swept SA measurement TRIG:<meas>:SOUR FRAM Measurements other than Swept SA
State Saved	Saved in instrument state
Readback	[Sync: <value of Sync Source>], for example, [Sync: External 1]
Status Bits/OPC dependencies	The Status Operation Register bit 5 "Waiting for Trigger" is set at the same time as the Sweeping or Measuring bit is set. It is cleared when the trigger actually occurs (that is, after the trigger event occurs and all the applicable trigger criteria have been met). A corresponding pop-up message ("Waiting for trigger") is generated if no trigger signal appears after approximately 2 sec. This message goes away when a trigger signal appears.
Initial S/W Revision	Prior to A.02.00

Periodic Timer Triggering:

This feature selects the internal periodic timer signal as the trigger. Trigger occurrences are set by the **Periodic Timer** parameter, which is modified by the **Sync Source** and **Offset**.

The figure below shows the action of the periodic timer trigger. Before reviewing the figure, we'll explain some uses for the periodic trigger.

A common application is measuring periodic burst RF signals for which a trigger signal is not easily

Common Measurement Functions 1

external synchronization pulse by resetting the internal state of the timer circuit.

Key Path	Trigger, Periodic Timer
Remote Command	:TRIGger[:SEQuence]:FRAMe:PERiod <time> :TRIGger[:SEQuence]:FRAMe:PERiod?
Example	TRIG:FRAM:PER 100 ms
Dependencies	The invalid data indicator turns on when the period is changed, until the next sweep/measurement completes.
Couplings	The same period is used in the Gate Source selection of the period timer.
Preset	20 ms GSM: 4.615383
State Saved	Saved in instrument state
Min	100.000 ns
Max	559.0000 ms
Default Unit	S
Initial S/W Revision	Prior to A.02.00

Offset

Adjusts the accumulated offset between the periodic timer events and the trigger event. Adjusting the accumulated offset is different than setting an offset, and requires explanation.

The periodic timer is usually not synchronized with any external events, so the timing of its output events has no absolute meaning. Since the timing relative to external events (RF signals) is important, you need to be able to adjust (offset) it. However, you have no direct way to see when the periodic timer events occur. All that you can see is the trigger timing. When you want to adjust the trigger timing, you will be changing the internal offset between the periodic timer events and the trigger event. Because the absolute value of that internal offset is unknown, we will just call that the accumulated offset. Whenever the Offset parameter is changed, you are changing that accumulated offset. You can reset the displayed offset using Reset Offset Display. Changing the display does not change the value of the accumulated offset, and you can still make additional changes to accumulated offset.

To avoid ambiguity, we define that an increase in the "offset" parameter, either from the knob or the SCPI adjust command, serves to delay the timing of the trigger event.

Key Path	Trigger, Periodic Timer
Remote Command	:TRIGger[:SEQuence]:FRAMe:OFFSet <time> :TRIGger[:SEQuence]:FRAMe:OFFSet?
Example	TRIG:FRAM:OFFS 1.2 ms

Notes	<p>The front panel interface (for example, the knob), and this command, adjust the accumulated offset, which is shown on the active function display. However, the actual amount sent to the hardware each time the offset is updated is the delta value, that is, the current accumulated offset value minus the previous accumulated offset value. Note that the accumulated offset value is essentially arbitrary; it represents the accumulated offset from the last time the offset was zeroed (with the Reset Offset Display key).</p> <p>Note that this command does not change the period of the trigger waveform. Note also that Offset is used only when the sync source is set to OFF, otherwise delay is used, see section “Trig Delay” on page 1627.</p> <p>An increase in the "offset" parameter, either from the knob or the SCPI adjust command, serves to delay the timing of the trigger event.</p>
Notes	<p>When the SCPI command is sent the value shown on the key (and the Active Function, if this happens to be the active function) is updated with the new value. However, the actual amount sent to the hardware is the delta value, that is, the current accumulated offset value minus the previous accumulated offset value.</p> <p>The SCPI query simply returns the value currently showing on the key.</p>
Dependencies	The invalid data indicator turns on when the offset is changed, until the next sweep/measurement completes.
Couplings	The same offset is used in the Gate Source selection of the period timer.
Preset	0 s
State Saved	Saved in instrument state
Min	-10.000 s
Max	10.000 s
Default Unit	S
Initial S/W Revision	Prior to A.02.00

Offset Adjust (Remote Command Only)

This remote command does not work at all like the related front panel keys. This command lets you advance the phase of the frame trigger by the amount you specify.

It does not change the period of the trigger waveform. If the command is sent multiple times, it advances the phase of the frame trigger an additional amount each time it is sent. Negative numbers are permitted.

Remote Command	<code>:TRIGger[:SEquence]:FRAMe:ADJust <time></code>
Example	TRIG:FRAM:ADJ 1.2 ms
Notes	<p>Note also that Offset is used only when the sync source is set to OFF, otherwise delay is used, see section “Trig Delay” on page 1627</p> <p>An increase in the "offset" parameter, either from the knob or the SCPI adjust command, serves to delay the timing of the trigger event.</p>

Common Measurement Functions 1

Notes	<p>The front panel interface (for example, the knob) and the :TRIG:FRAM:OFFS command adjust the accumulated offset, which is shown on the active function display. However, the actual amount sent to the hardware is the delta value, that is, the current offset value minus the previous offset value.</p> <p>When the SCPI command is sent the value shown on the key (and the Active Function, if this happens to be the active function) is updated by increasing it (or decreasing it if the value sent is negative) by the amount specified in the SCPI command.</p> <p>This is a "command only" SCPI command, with no query.</p>
Dependencies	The invalid data indicator turns on when the offset is changed, until the next sweep/measurement completes.
Couplings	The same offset is used in the Gate Source selection of the period timer.
Preset	0 s
State Saved	Saved in instrument state
Min	-10.000 s
Max	10.000 s
Default Unit	S
Initial S/W Revision	Prior to A.02.00

Reset Offset Display

Resets the value of the periodic trigger offset display setting to 0.0 seconds. The current displayed trigger location may include an offset value defined with the **Offset** key. Pressing this key redefines the currently displayed trigger location as the new trigger point that is 0.0 s offset. The **Offset** key can then be used to add offset relative to this new timing.

Key Path	Trigger, Periodic Timer
Remote Command	:TRIGger[:SEquence]:FRAMe:OFFSet:DISPlay:RESet
Example	TRIG:FRAM:OFFS:DISP:RES
Initial S/W Revision	Prior to A.02.00

Sync Source

Selects a signal source for you to synchronize your periodic timer trigger to, otherwise you are triggering at some arbitrary location in the frame. Synchronization reduces the precision requirements on the setting of the period.

For convenience you may adjust the level and slope of the selected sync source in a conditional branch setup menu accessed from the Sync Source menu. Note that these settings match those in the **Trigger** and **Gate Source** menus; that is, each trigger source has only one value of level and slope, regardless of which menu it is accessed from.

Key Path	Trigger, Periodic Timer
----------	--------------------------------

Remote Command	:TRIGger[:SEquence]:FRAMe:SYNC EXTernal1 EXTernal2 RFBurst OFF :TRIGger[:SEquence]:FRAMe:SYNC?
Example	TRIG:FRAM:SYNC EXT2
Dependencies	In some models, there is no second External input. In these models, the External 2 key is blanked and the EXTernal2 parameter will generate a “Hardware missing; Not available for this model number” message.
Preset	Off GSM/EDGE: RFBurst
State Saved	Saved in instrument state
Readback	The current setting is read back to this key and it is also Readback to the previous Periodic Timer trigger key.
Backwards Compatibility SCPI	:TRIGger[:SEquence]:FRAMe:SYNC EXTernal For backward compatibility, the parameter EXTernal is mapped to EXTernal1
Initial S/W Revision	Prior to A.02.00
Modified at S/W Revision	A.03.00

Off

Turns off the sync source for your periodic trigger. With the sync source off, the timing will drift unless the signal source frequency is locked to the analyzer frequency reference.

Key Path	Trigger, Periodic Timer, Sync Source
Example	TRIG:FRAM:SYNC OFF
Readback	Off
Initial S/W Revision	Prior to A.02.00

External 1

Pressing this key, when it is not selected, selects the external input port that you will use for the periodic trigger synchronization. Pressing this key, when it is already selected, accesses the external 1 sync source setup menu.

Key Path	Trigger, Periodic Timer, Sync Source
Example	TRIG:FRAM:SYNC EXT
Couplings	Same as External 1 trigger source.
Readback	External 1
Initial S/W Revision	Prior to A.02.00

Common Measurement Functions 1

Trigger Level

Sets the value where the signal at the external 1 trigger input will synchronize with the periodic timer trigger. This same level is used in the Ext1 trigger source in the Trigger menu. See section [“Trigger Level ” on page 1611](#) for information on this key and the SCPI command.

Trig Slope

Controls the trigger polarity. It is set positive to trigger on a rising edge and negative to trigger on a falling edge. This same value is used in the Ext1 trigger source in the Trigger menu. See section [“Trig Slope ” on page 1612](#) for information on this key and the SCPI command

External 2

Pressing this key, when it is not selected, selects the external input port that you will use for the periodic frame trigger synchronization.

Pressing this key, when it is already selected, accesses the external 2 sync source setup menu.

Key Path	Trigger, Periodic Timer, Sync Source
Example	TRIG:FRAM:SYNC EXT2
Dependencies	In some models, there is no second External input. In these models, the External 2 key is blanked and the EXTernal2 parameter will generate a “Hardware missing; Not available for this model number” message.
Couplings	Same as External 2 trigger source.
Readback	External 2
Initial S/W Revision	Prior to A.02.00
Modified at S/W Revision	A.03.00

Trigger Level

Sets the value where the signal at the external 2 trigger input will synchronize with the periodic timer trigger. This same level is used in the Ext2 trigger source in the Trigger menu. See section [“Trigger Level ” on page 1614](#) for information on this key and the SCPI command.

Trig Slope

Controls the trigger polarity. It is set positive to trigger on a rising edge and negative to trigger on a falling edge. This same value is used in the Ext2 trigger source in the Trigger menu. See section [“Trig Slope ” on page 1614](#) for information on this key and the SCPI command

RF Burst

Pressing the key once selects the RF burst envelope signal to be used for the periodic timer trigger synchronization.

Press the key a second time to access the RF burst sync source setup menu.

Key Path	Trigger, Periodic Timer, Sync Source
Example	TRIG:FRAM:SYNC RFB
Couplings	Same as RF Burst trigger source.

Readback	RF Burst
Initial S/W Revision	Prior to A.02.00

Trigger Level

Sets the trigger level to be used for the RF Burst trigger. This same level is used in the RF Burst trigger source in the Trigger menu. See section “[Absolute Trigger Level](#)” on page 1616 for information on this key and the SCPI command.

Trig Slope

Controls the RF Burst trigger polarity. It is set positive to trigger on a rising edge and negative to trigger on a falling edge. This same value is used in the RF Burst trigger source in the Trigger menu. See section “[Trigger Slope](#)” on page 1619 for information on this key and the SCPI command

Trig Delay

This setting delays the measurement timing relative to the Periodic Timer.

Key Path	Trigger, Periodic Timer
Remote Command	:TRIGger[:SEquence]:FRAMe:DELay <time> :TRIGger[:SEquence]:FRAMe:DELay? :TRIGger[:SEquence]:FRAMe:DELay:STATe OFF ON 0 1 :TRIGger[:SEquence]:FRAMe:DELay:STATe?
Notes	Note that delay is used when the sync source is not set to OFF. If the sync source is set to OFF, offset is used.
Preset	Off, 1.000 us
State Saved	Saved in instrument state
Min	-150 ms
Max	+500 ms
Default Unit	s
Initial S/W Revision	Prior to A.02.00

Sync Holdoff

Sync Holdoff specifies the duration that the sync source signal must be kept false before the transition to true to be recognized as the sync timing. The periodic timer phase is aligned when the sync source signal becomes true, after the Holdoff time is satisfied.

A holdoff of 2 ms will work with most WiMAX signals, but there may be cases where the burst off duration is less than 1 ms and this value will need to be changed.

Key Path	Trigger, Periodic Timer
----------	-------------------------

Common Measurement Functions 1

Remote Command	:TRIGger[:SEquence]:FRAME:SYNC:HOLDoff <time> :TRIGger[:SEquence]:FRAME:SYNC:HOLDoff? :TRIGger[:SEquence]:FRAME:SYNC:HOLDoff:STATe OFF ON 0 1 :TRIGger[:SEquence]:FRAME:SYNC:HOLDoff:STATe?
Preset	On, 1.000 ms
State Saved	Saved in instrument state
Min	0 ms
Max	+500 ms
Default Unit	s
Initial S/W Revision	Prior to A.02.00

TV

Pressing this key, when it is not selected, selects the TV input signal as the trigger. A new sweep/measurement will start synchronized with the next occurrence of the synchronizing pulse of a selected TV line

Pressing this key, when it is already selected, sets the desired line number accesses the other TV trigger setup functions.

The Frame and Field options enable you to determine how the fields of the TV picture signal will be affected by the trigger system. One complete TV image consists of one frame of 525 or 625 horizontal lines depending on the TV standard being used. Each frame is composed of two fields of interlacing lines, each consisting of 262 1/2 lines (or 312 1/2 lines). The fields are called Field One and Field Two. Field One is viewed as having 263 lines (or 313 lines) and Field Two is viewed as having 262 lines (or 312 lines).

For the 525 line NTSC video standard, we refer to TV lines as follows (these are the Field Modes):

Entire Frame, lines 1 to 525

Field One, lines 1 to 263

Field Two, lines 1 to 262 (note that this really refers to "actual" lines 264 to 525)

For the 625 line PAL and SECAM video standards, we refer to TV lines as follows:

Entire Frame, lines 1 to 625

Field One, lines 1 to 313

Field Two, lines 314 to 625

As the Field is changed, the appropriate value for Line is chosen to keep triggering on the same line as before, or if this is not possible, the corresponding line in the new Field. For example, suppose line 264 is selected while in the NTSC-M standard and the Entire Frame mode. This is the first line in Field Two. If Field Two is then selected, the Line number changes to Line 1, the same actual line in the TV signal. If Field One is then selected, the line number stays at 1, but now we are triggering in the first line in Field One. The only exception to this is if we are on the last line of Field One and change to Field Two. In this

case, we go to the last line in Field Two.

Key Path	Trigger
Example	TRIG:SOUR TV Swept SA measurement TRIG:<meas>:SOUR TV Measurements other than Swept SA
Readback	This key displays the value read back from TV Line
Status Bits/OPC dependencies	The Status Operation Register bit 5 "Waiting for Trigger" is set at the same time as the Sweeping or Measuring bit is set. It is cleared when the trigger actually occurs (that is, after the trigger event occurs and all the applicable trigger criteria have been met). A corresponding pop-up message ("Waiting for trigger") is generated if no trigger signal appears after approximately 2 sec. This message goes away when a trigger signal appears.
Initial S/W Revision	Prior to A.02.00

TV Line

Selects the TV line number to trigger on. Line number range is dependent on the settings of the **Standard** and **Field** menus within the TV trigger setup functions. When the line number is incremented beyond the upper limit, the value will change to the lower limit and continue incrementing from there. When the line number is decremented below the lower limit, the value will change to the upper limit and continue decrementing from there.

Key Path	Trigger, TV
Remote Command	:TRIGger[:SEquence]:TV:LINE <integer> :TRIGger[:SEquence]:TV:LINE?
Example	TRIG:TV:LINE 20 TRIG:TV:LINE?
Notes	The range of the TV line number is dependent on the settings of the Standard and Field menus within the TV trigger setup functions.
Preset	17
State Saved	Saved in instrument state
Min	The minimum value is the minimum line, and rolls over to the maximum value. The minimum line number depends on which Field and standard are selected.
Max	The maximum value is the maximum line, and rolls over to the minimum value. The maximum line number depends on which Field and standard are selected.
Initial S/W Revision	Prior to A.02.00

Common Measurement Functions 1

Field

Accesses the menu to select the field.

Key Path	Trigger, TV
Remote Command	:TRIGger[:SEQuence]:TV:FMODe ENTire ODD EVEN :TRIGger[:SEQuence]:TV:FMODe?
Example	TRIG:TV:FMOD EVEN
Notes	ODD is Field 1 EVEN is Field 2
Dependencies	This command is available only when Option B7B (TV trigger) is installed.
Preset	ENTire
Readback	Displays the Readback value
Initial S/W Revision	Prior to A.02.00

Entire Frame

When you select Entire Frame it causes the selected line number to be viewed as an offset into the entire frame starting with line 1, the first line in Field One.

Key Path	Trigger, TV, Field
Example	TRIG:TV:FMOD ENT
Min	1, for all formats.
Max	525, for formats NTSC-M, NTSC-Japan, NTSC-4.43, PAL-M and PAL-60 625, for formats PAL-B, D, G, H, I, PAL-N, PAL-N Combin, and SECAM-L.
Readback	Entire Frame
Initial S/W Revision	Prior to A.02.00

Field One

When you select Field One it causes the selected line number to be viewed as an offset into the first field starting with Line 1, the first line in Field One.

Key Path	Trigger, TV, Field
Example	TRIG:TV:FMOD ODD
Min	Field 1 (ODD) The minimum line is 1

Max	Field 1 (ODD) Maximum line is 263 for formats NTSC-M, NTSC-Japan, NTSC-4.43, PAL-M and PAL-60 Maximum line is 313 for formats PAL-B, D, G, H, I, PAL-N, PAL-N Combin, and SECAM-L.
Readback	Field 1
Initial S/W Revision	Prior to A.02.00

Field Two

When you select Field Two it causes the selected line number to be viewed as an offset into the second field. If Line 1 is selected, it is the 264th line of the frame (NTSC-M, NTSC-Japan, NTSC-4.43, PAL-M, PAL-60) or the 314th line of the frame (PAL-B,D,G,H,I, PAL-N, PAL-N-Combin, SECAM-L).

Key Path	Trigger, TV, Field
Example	TRIG:TV:FMOD EVEN
Min	Field 2 (EVEN) The minimum line is 1
Max	Field 2 (EVEN) The maximum line 262 for formats NTSC-M, NTSC-Japan, NTSC-4.43, PAL-M and PAL-60 The maximum line is 312 for formats PAL-B, D, G, H, I, PAL-N, PAL-N Combin, and SECAM-L
Readback	Field 2
Initial S/W Revision	Prior to A.02.00

Standard

Accesses the Standard menu keys which select from the following TV standards: **NTSC-M, NTSC-Japan, NTSC-4.43, PAL-M, PAL-B,D,G,H,I, PAL-N, PAL-N-Combin, PAL-60, SECAM-L.**

As the TV standard is changed, the current line value is clipped as necessary to keep it valid for the chosen standard and field mode. For example, line 600 is selected in Entire Frame mode in PAL-N; if NTSC-M is selected, the line number is clipped to 525. Or, if line 313 is selected in Field 1 mode in PAL-N and NTSC-M is selected, the line number is clipped to 263. Changing back to the PAL-N standard will leave the line number at 263.

Key Path	Trigger, TV
Remote Command	:TRIGger[:SEquence]:TV:STANDARD MNTSc JNTSc NTSC443 MPAL BPAL NPAL CPAL PAL60 LSEC :TRIGger[:SEquence]:TV:STANDARD?

Common Measurement Functions 1

Example	TRIG:TV:STANdard MPAL TRIG:TV:STA?
Preset	MNTSC
State Saved	Saved in instrument state
Readback	Displays Readback value
Initial S/W Revision	Prior to A.02.00

NTSC-M

Sets the TV standard to **NTSC-M**.

Key Path	Trigger, TV, Standard
Example	TRIG:TV:STAN MNTS
Readback	NTSC-M
Initial S/W Revision	Prior to A.02.00

NTSC-Japan

Sets the TV standard to **NTSC-Japan**.

Key Path	Trigger, TV, Standard
Example	TRIG:TV:STAN JNTS
Readback	NTSC-Japan
Initial S/W Revision	Prior to A.02.00

NTSC-4.43

Sets the TV standard to **NTSC-4.43**.

Key Path	Trigger, TV, Standard
Example	TRIG:TV:STAN NTSC443
Readback	NTSC-Japan
Initial S/W Revision	Prior to A.02.00

PAL-M

Sets the TV standard to **PAL-M**.

Key Path	Trigger, TV, Standard
Example	TRIG:TV:STAN MPAL
Readback	PAL-M

Initial S/W Revision	Prior to A.02.00
----------------------	------------------

PAL-N

Sets the TV standard to **PAL-N**.

Key Path	Trigger, TV, Standard
Example	TRIG:TV:STAN NPAL
Readback	PAL-N
Initial S/W Revision	Prior to A.02.00

PAL-N-Combin

Sets the TV standard to **PAL-N-Combin**.

Key Path	Trigger, TV, Standard
Example	TRIG:TV:STAN CPAL
Readback	PAL-N-C
Initial S/W Revision	Prior to A.02.00

PAL-B,D,G,H,I

Sets the TV standard to **PAL-B,D,G,H,I**

Key Path	Trigger, TV, Standard
Example	TRIG:TV:STAN BPAL
Readback	PAL-B
Initial S/W Revision	Prior to A.02.00

PAL-60

Sets the TV standard to **PAL-60**.

Key Path	Trigger, TV, Standard
Example	TRIG:TV:STAN PAL60
Readback	PAL-N
Initial S/W Revision	Prior to A.02.00

SECAM-L

Sets the TV standard to **SECAM-L**.

Key Path	Trigger, TV, Standard
----------	------------------------------

Common Measurement Functions 1

Example	TRIG:TV:STAN LSEC
Readback	SECAM-L
Initial S/W Revision	Prior to A.02.00

Baseband I/Q

Pressing this key when it is not selected selects Baseband I/Q as the trigger. Pressing the key when it is already selected accesses the Baseband I/Q trigger type selection menu. The key is annotated to display which of the Baseband I/Q trigger types is currently selected.

Key Path	Trigger
State Saved	Saved in instrument state
Readback	The Baseband I/Q trigger source that becomes active when this key is selected is displayed. The possible values are "I/Q Mag", "I", "Q", "Input I", "Input Q", and "Aux I/Q Mag".
Initial S/W Revision	Prior to A.02.00

I/Q Mag

Pressing this key, when it is not selected, selects the I/Q magnitude signal as the trigger. The I/Q Magnitude trigger condition is met when the I/Q magnitude crosses the I/Q magnitude trigger level. The magnitude is measured at the output of the main I/Q digital receiver.

Key Path	Trigger, Baseband I/Q
Example	TRIG:<meas>:SOUR IQM
Readback Text	I/Q Mag
Initial S/W Revision	Prior to A.02.00

Trigger Level

Sets a level for the I/Q magnitude trigger. When the signal crosses this level, with the chosen slope, the trigger occurs. If the specific Measurement displays the signal from the chosen sampling point a green line will be displayed to indicate the trigger level.

Key Path	Trigger, Baseband I/Q, I/Q Mag
Remote Command	:TRIGger[:SEquence]:IQMag:LEVel <ampl > :TRIGger[:SEquence]:IQMag:LEVel?
Example	TRIG:IQM:LEV -30 dBm
Notes	The I/Q reference impedance is used for converting between power and voltage.
Preset	-25 dBm
State Saved	Saved in instrument state

Range	-200 dBm to 100 dBm
Readback Text	<level> dBm
Initial S/W Revision	Prior to A.02.00

Trig Slope

Controls the trigger polarity. It is set positive to trigger on a rising edge and negative to trigger on a falling edge.

Key Path	Trigger, Baseband I/Q, I/Q Mag
Remote Command	:TRIGger[:SEquence]:IQMag:SLOPe POSitive NEGative :TRIGger[:SEquence]:IQMag:SLOPe?
Example	TRIG:IQM:SLOP POS
Preset	POSitive
State Saved	Saved in instrument state
Initial S/W Revision	Prior to A.02.00

Trig Delay

Controls a time delay during which the analyzer will wait to begin a sweep after meeting the trigger criteria. You can use negative delay to pre-trigger the instrument in time domain or FFT.

Key Path	Trigger, Baseband I/Q, I/Q Mag
Remote Command	:TRIGger[:SEquence]:IQMag:DELAy <time> :TRIGger[:SEquence]:IQMag:DELAy? :TRIGger[:SEquence]:IQMag:DELAy:STATe OFF ON 0 1 :TRIGger[:SEquence]:IQMag:DELAy:STATe?
Example	TRIG:IQM:DEL 10 ms TRIG:IQM:DEL:STAT ON
Preset	1 us OFF
State Saved	Saved in instrument state
Range	-2.5 s to +10 s
Initial S/W Revision	Prior to A.02.00

I (Demodulated)

Pressing this key, when it is not selected, selects the main receiver's output I voltage as the trigger. The I (Demodulated) trigger condition is met when the I voltage crosses the I voltage trigger level.

Key Path	Trigger, Baseband I/Q
----------	------------------------------

Common Measurement Functions 1

Example	TRIG:<meas>:SOUR IDEM
Readback Text	I
Initial S/W Revision	Prior to A.02.00

Trigger Level

Sets a level for the I (Demodulated) trigger. When the signal crosses this level, with the chosen slope, the trigger occurs. If the specific Measurement displays the signal from the chosen sampling point a green line will be displayed to indicate the trigger level.

Key Path	Trigger, Baseband I/Q, I (Demodulated)
Remote Command	:TRIGger[:SEquence]:IDEMod:LEVel <voltage> :TRIGger[:SEquence]:IDEMod:LEVel?
Example	TRIG:IDEM:LEV 0.5 V
Preset	0.25 V
State Saved	Saved in instrument state
Range	-1 to 1 V
Readback Text	0.1 of displayed unit (V, mV, etc.)
Initial S/W Revision	Prior to A.02.00

Trig Slope

Controls the trigger polarity. It is set positive to trigger on a rising edge and negative to trigger on a falling edge.

Key Path	Trigger, Baseband I/Q, I (Demodulated)
Remote Command	:TRIGger[:SEquence]:IDEMod:SLOPe POSitive NEGative :TRIGger[:SEquence]:IDEMod:SLOPe?
Example	TRIG:IDEM:SLOP POS
Preset	POSitive
State Saved	Saved in instrument state
Initial S/W Revision	Prior to A.02.00

Trig Delay

Controls a time delay during which the analyzer will wait to begin a sweep after meeting the trigger criteria. You can use negative delay to pre-trigger the instrument in time domain or FFT.

Key Path	Trigger, Baseband I/Q, I (Demodulated)
----------	---

Remote Command	:TRIGger[:SEquence]:IDEMod:DELay <time> :TRIGger[:SEquence]:IDEMod:DELay? :TRIGger[:SEquence]:IDEMod:DELay:STATe OFF ON 0 1 :TRIGger[:SEquence]:IDEMod:DELay:STATe?
Example	TRIG:IDEM:DEL 10 ms TRIG:IDEM:DEL:STAT ON
Preset	1 us OFF
State Saved	Saved in instrument state
Range	-2.5 s to +10 s
Initial S/W Revision	Prior to A.02.00

Q (Demodulated)

Pressing this key, when it is not selected, selects the main receiver's output Q voltage as the trigger. The Q (Demodulated) trigger condition is met when the Q voltage crosses the Q voltage trigger level.

Key Path	Trigger, Baseband I/Q
Example	TRIG:<meas>:SOUR QDEM
Readback Text	Q
Initial S/W Revision	Prior to A.02.00

Trigger Level

Sets a level for the Q (Demodulated) trigger. When the signal crosses this level, with the chosen slope, the trigger occurs. If the specific Measurement displays the signal from the chosen sampling point a green line will be displayed to indicate the trigger level.

Key Path	Trigger, Baseband I/Q, Q (Demodulated)
Remote Command	:TRIGger[:SEquence]:QDEMod:LEVel <voltage> :TRIGger[:SEquence]:QDEMod:LEVel?
Example	TRIG:QDEM:LEV 0.5 V
Preset	0.25 V
State Saved	Saved in instrument state
Range	-1 to 1 V
Readback Text	0.1 of displayed unit (V, mV, etc.)
Initial S/W Revision	Prior to A.02.00

Common Measurement Functions 1

Trig Slope

Controls the trigger polarity. It is set positive to trigger on a rising edge and negative to trigger on a falling edge.

Key Path	Trigger, Baseband I/Q, Q (Demodulated)
Remote Command	:TRIGger[:SEquence]:QDEMod:SLOPe POSitive NEGative :TRIGger[:SEquence]:QDEMod:SLOPe?
Example	TRIG:QDEM:SLOP POS
Preset	POSitive
State Saved	Saved in instrument state
Initial S/W Revision	Prior to A.02.00

Trig Delay

Controls a time delay during which the analyzer will wait to begin a sweep after meeting the trigger criteria. You can use negative delay to pre-trigger the instrument in time domain or FFT.

Key Path	Trigger, Baseband I/Q, Q (Demodulated)
Remote Command	:TRIGger[:SEquence]:QDEMod:DELay <time> :TRIGger[:SEquence]:QDEMod:DELay? :TRIGger[:SEquence]:QDEMod:DELay:STATe OFF ON 0 1 :TRIGger[:SEquence]:QDEMod:DELay:STATe?
Example	TRIG:QDEM:DEL 10 ms TRIG:QDEM:DEL:STAT ON
Preset	1 us OFF
State Saved	Saved in instrument state
Range	-2.5 s to +10 s
Initial S/W Revision	Prior to A.02.00

Input I

Pressing this key, when it is not selected, selects the I channel's ADC voltage as the trigger. The Input I trigger condition is met when the voltage crosses the trigger level.

Key Path	Trigger, Baseband I/Q
Example	TRIG:<meas>:SOUR IINP
Readback Text	Input I
Initial S/W Revision	Prior to A.02.00

Trigger Level

Sets a level for the Input I trigger. When the signal crosses this level, with the chosen slope, the trigger occurs.

Key Path	Trigger, Baseband I/Q, Input I
Remote Command	:TRIGger[:SEquence]:IINPut:LEVel <voltage> :TRIGger[:SEquence]:IINPut:LEVel?
Example	TRIG:IINP:LEV 0.5 V
Preset	0.25 V
State Saved	Saved in instrument state
Range	-1 to 1 V
Readback Text	0.1 of displayed unit (V, mV, etc.)
Initial S/W Revision	Prior to A.02.00

Trig Slope

Controls the trigger polarity. It is set positive to trigger on a rising edge and negative to trigger on a falling edge.

Key Path	Trigger, Baseband I/Q, Input I
Remote Command	:TRIGger[:SEquence]:IINPut:SLOPe POSitive NEGative :TRIGger[:SEquence]:IINPut:SLOPe?
Example	TRIG:IINP:SLOP POS
Preset	POSitive
State Saved	Saved in instrument state
Initial S/W Revision	Prior to A.02.00

Trig Delay

Controls a time delay during which the analyzer will wait to begin a sweep after meeting the trigger criteria. You can use negative delay to pre-trigger the instrument in time domain or FFT.

Key Path	Trigger, Baseband I/Q, Input I
Remote Command	:TRIGger[:SEquence]:IINPut:DELay <time> :TRIGger[:SEquence]:IINPut:DELay? :TRIGger[:SEquence]:IINPut:DELay:STATe OFF ON 0 1 :TRIGger[:SEquence]:IINPut:DELay:STATe?
Example	TRIG:IINP:DEL 10 ms TRIG:IINP:DEL:STAT ON

Common Measurement Functions 1

Preset	1 us OFF
State Saved	Saved in instrument state
Range	-2.5 s to +10 s
Initial S/W Revision	Prior to A.02.00

Input Q

Pressing this key, when it is not selected, selects the Q channel's ADC voltage as the trigger. The Input Q trigger condition is met when the voltage crosses the trigger level.

Key Path	Trigger, Baseband I/Q
Example	TRIG:<meas>:SOUR QINP
Readback Text	Input Q
Initial S/W Revision	Prior to A.02.00

Trigger Level

Sets a level for the Input Q trigger. When the signal crosses this level, with the chosen slope, the trigger occurs.

Key Path	Trigger, Baseband I/Q, Input Q
Remote Command	:TRIGger[:SEquence]:QINPut:LEVel <voltage> :TRIGger[:SEquence]:QINPut:LEVel?
Example	TRIG:QINP:LEV 0.5 V
Preset	0.25 V
State Saved	Saved in instrument state
Range	-1 to 1 V
Readback Text	0.1 of displayed unit (V, mV, etc.)
Initial S/W Revision	Prior to A.02.00

Trig Slope

Controls the trigger polarity. It is set positive to trigger on a rising edge and negative to trigger on a falling edge.

Key Path	Trigger, Baseband I/Q, Input Q
Remote Command	:TRIGger[:SEquence]:QINPut:SLOPe POSitive NEGative :TRIGger[:SEquence]:QINPut:SLOPe?
Example	TRIG:QINP:SLOP POS
Preset	POSitive

State Saved	Saved in instrument state
Initial S/W Revision	Prior to A.02.00

Trig Delay

Controls a time delay during which the analyzer will wait to begin a sweep after meeting the trigger criteria. You can use negative delay to pre-trigger the instrument in time domain or FFT.

Key Path	Trigger, Baseband I/Q, Input Q
Remote Command	:TRIGger[:SEquence]:QINPut:DELay <time> :TRIGger[:SEquence]:QINPut:DELay? :TRIGger[:SEquence]:QINPut:DELay:STATe OFF ON 0 1 :TRIGger[:SEquence]:QINPut:DELay:STATe?
Example	TRIG:QINP:DEL 10 ms TRIG:QINP:DEL:STAT ON
Preset	1 us OFF
State Saved	Saved in instrument state
Range	-2.5 s to +10 s
Initial S/W Revision	Prior to A.02.00

Auxiliary Channel I/Q Mag

Pressing this key, when it is not selected, selects the Auxiliary Channel I/Q magnitude signal as the trigger. The Auxiliary Channel I/Q Magnitude trigger condition is met when the auxiliary receiver's I/Q magnitude output crosses the Auxiliary I/Q magnitude trigger level.

Key Path	Trigger, Baseband I/Q
Example	TRIG:<meas>:SOUR AIQM
Readback Text	Aux I/Q Mag
Initial S/W Revision	Prior to A.02.00

Trigger Level

Sets a level for the I/Q magnitude trigger. When the signal crosses this level, with the chosen slope, the trigger occurs.

Key Path	Trigger, Baseband I/Q, Aux Channel I/Q Mag
Remote Command	:TRIGger[:SEquence]:AIQMag:LEVel <ampl > :TRIGger[:SEquence]:AIQMag:LEVel?
Example	TRIG:AIQM:LEV -30 dBm

Common Measurement Functions 1

Notes	The I/Q reference impedance is used for converting between power and voltage.
Preset	-25 dBm
State Saved	Saved in instrument state
Range	-200 dBm to 100 dBm
Readback Text	<level> dBm
Initial S/W Revision	Prior to A.02.00

Trig Slope

Controls the trigger polarity. It is set positive to trigger on a rising edge and negative to trigger on a falling edge.

Key Path	Trigger, Baseband I/Q, Aux Channel I/Q Mag
Remote Command	:TRIGger[:SEquence]:AIQMag:SLOPe POSitive NEGative :TRIGger[:SEquence]:AIQMag:SLOPe?
Example	TRIG:AIQM:SLOP POS
Preset	POSitive
State Saved	Saved in instrument state
Initial S/W Revision	Prior to A.02.00

Trig Delay

Controls a time delay during which the analyzer will wait to begin a sweep after meeting the trigger criteria. You can use negative delay to pre-trigger the instrument in time domain or FFT.

Key Path	Trigger, Baseband I/Q, Aux Channel I/Q Mag
Remote Command	:TRIGger[:SEquence]:AIQMag:DELay <time> :TRIGger[:SEquence]:AIQMag:DELay? :TRIGger[:SEquence]:AIQMag:DELay:STATe OFF ON 0 1 :TRIGger[:SEquence]:AIQMag:DELay:STATe?
Example	TRIG:AIQM:DEL 10 ms TRIG:AIQM:DEL:STAT ON
Preset	1 us OFF
State Saved	Saved in instrument state
Range	-2.5 s to +10 s
Initial S/W Revision	Prior to A.02.00

Trigger Center Frequency

This key sets the center frequency to be used by the auxiliary receiver.

Key Path	Trigger, Baseband I/Q, Aux Channel I/Q Mag
Remote Command	:TRIGger[:SEquence]:AIQMag:CENTer <freq> :TRIGger[:SEquence]:AIQMag:CENTer?
Example	:TRIG:AIQM:CENT 10 MHz
Notes	Trigger CF + 1/2 Trigger BW < Max Trigger CF – 1/2 Trigger BW > Min
Preset	0 Hz
State Saved	Saved in instrument state
Range	–40 MHz to 40 MHz
Initial S/W Revision	Prior to A.02.00

Trigger Bandwidth

This key sets the information bandwidth used by the auxiliary receiver for the Auxiliary Channel I/Q Magnitude trigger.

Key Path	Trigger, Baseband I/Q, Aux Channel I/Q Mag
Remote Command	:TRIGger[:SEquence]:AIQMag:BANDwidth <freq> :TRIGger[:SEquence]:AIQMag:BANDwidth?
Example	:TRIG:AIQM:BAND 8 MHz
Notes	The combined sample rate for the main and auxiliary receivers cannot exceed 100 MSa/sec. The bandwidth available to the Trigger BW is limited to what is available after the main receiver's bandwidth (Info BW, sometimes pre-FFT BW) is set. Because of this limitation, the Max is not always achievable. The combination of Trigger Center Freq and Trigger BW is also limited: Trigger CF + 1/2 Trigger BW < Max Trigger CF – 1/2 Trigger BW > Min
Preset	Bandwidth option dependent: No Opt: 10 MHz Opt B25: 25 MHz Opt S40: 40 MHz
State Saved	Saved in instrument state
Range	10 Hz to Maximum
Initial S/W Revision	Prior to A.02.00

Common Measurement Functions 1

Auto/Holdoff

Opens up a menu that lets you adjust Auto Trigger and Trigger Holdoff parameters

Key Path	Trigger
Readback line	<p>Displays a summary of the Auto Trig and Holdoff settings, in square brackets</p> <p>First line: Auto Off or Auto On</p> <p>Second Line: "Hldf" followed by:</p> <ul style="list-style-type: none"> • If Holdoff is Off, readback Off • If Holdoff On and Type = Normal, readback value • If Holdoff On and Type = Above, readback value followed by AL • If Holdoff On and Type = Below, readback value followed by BL • If Holdoff Type selection is not supported by the current measurement, Holdoff Type is always Normal
Initial S/W Revision	A.02.00

Auto Trig

Sets the time that the analyzer will wait for the trigger conditions to be met. If they are not met after that much time, then the analyzer is triggered anyway.

Key Path	Trigger, Auto/Holdoff
Remote Command	<pre>:TRIGger[:SEquence]:ATRigger <time> :TRIGger[:SEquence]:ATRigger? :TRIGger[:SEquence]:ATRigger:STATE OFF ON 0 1 :TRIGger[:SEquence]:ATRigger:STATE?</pre>
Example	<pre>TRIG:ATR:STAT ON TRIG:ATR 100 ms</pre>
Notes	The "time that the analyzer will wait" starts when the analyzer is ready for a trigger, which may be hundreds of ms after the data acquisition for a sweep is done. The "time" ends when the trigger condition is satisfied, not when the delay ends.
Preset	Off, 100 ms
State Saved	Saved in instrument state
Min	1 ms
Max	100 s
Default Unit	s
Initial S/W Revision	Prior to A.02.00

Trig Holdoff

Sets the holdoff time between triggers. When the trigger condition is satisfied, the trigger occurs, the delay begins, and the holdoff time begins. New trigger conditions will be ignored until the holdoff time expires. For a free-running trigger, the holdoff value is the minimum time between triggers.

Key Path	Trigger, Auto/Holdoff
Remote Command	:TRIGger[:SEQuence]:HOLDoff <time> :TRIGger[:SEQuence]:HOLDoff? :TRIGger[:SEQuence]:HOLDoff:STATE OFF ON 0 1 :TRIGger[:SEQuence]:HOLDoff:STATE?
Example	TRIG:HOLD:STAT ON TRIG:HOLD 100 ms
Preset	Off, 100 ms
State Saved	Saved in instrument state
Min	0 s
Max	0.5 s
Default Unit	s
Initial S/W Revision	Prior to A.02.00

Holdoff Type

Lets you set the Trigger Holdoff Type.

NOTE Holdoff Type is not supported by all measurements. If the current measurement does not support it, this key will be blank and the Holdoff Type will be Normal. If the Holdoff Type SCPI is sent while in such a measurement, the SCPI will be accepted and the setting remembered, but it will have no effect until a measurement is in force that supports Holdoff Type.

Trigger Holdoff Type functionality:

- **NORMal**
This is the “oscilloscope” type of trigger holdoff, and is the setting when the Holdoff Type key does not appear. In this type of holdoff, no new trigger will be accepted until the holdoff interval has expired after the previous trigger.
- **ABOVE**
If the trigger slope is positive, a trigger event is generated only if the signal characteristic of interest crosses the trigger threshold (with positive slope) and then remains above the threshold for at least the holdoff time. For negative slope, the trigger event is generated if the signal characteristic crosses the threshold (with negative slope) after having been above the threshold for at least the holdoff time. In either case, the trigger event is associated with the time the level was crossed.

Common Measurement Functions 1

- **BELow**
If the trigger slope is positive, a trigger event is generated only if the signal characteristic of interest crosses the trigger threshold (with positive slope) after having been below the threshold for at least the holdoff time. For negative slope, the trigger event is generated if the signal characteristic crosses the threshold (with negative slope) and then remains below the threshold for at least the holdoff time. In either case, the trigger event is associated with the time the level was crossed.

Key Path	Trigger, Auto/Holdoff
Remote Command	:TRIGger[:SEQuence]:HOLDoff:TYPE NORMal ABOve BELow :TRIGger[:SEQuence]:HOLDoff:TYPE?
Example	TRIG:HOLD:TYPE NORM
Preset	All modes but GSM/EDGE: Normal GSM/EDGE: Below
State Saved	Saved in instrument state
Initial S/W Revision	A.02.00

View/Display

The View/Display key opens up the Display Menu (common to most measurements) and the View menu for the current measurement.

Some measurements have simple View menus, or even no View menu, others provide many different Views.

Views are different ways of looking at data, usually different ways of looking at the same data, especially when the data represents a time record that is being digitally processed with an FFT and/or other digital signal processing algorithms.

Key Path	Front-panel key
Initial S/W Revision	Prior to A.02.00

Display

The **Display** menu is common to most measurements, and is used for configuring items on the display. Some **Display** menu settings apply to all the measurements in a mode, and some only to the current measurement. Those under the **System Display Settings** key apply to all measurements in all modes.

Key Path:	Display
Key Path:	Front-panel key
Initial S/W Revision:	Prior to A.02.00

Annotation

Turns on and off various parts of the display annotation. The annotation is divided up into four categories:

1. Meas Bar: This is the measurement bar at the top of the screen. It does not include the settings panel or the Active Function. Turning off the Meas Bar turns off the settings panel and the Active Function. When the Meas Bar is off, the graticule area expands to fill the area formerly occupied by the Meas Bar.
2. Screen Annotation: this is the annotation and annunciation around the graticule, including any annotation on lines (such as the display line, the threshold line, etc.) This does NOT include the marker number or the N dB result. When off, the graticule expands to fill the entire graticule area.
3. Trace annotation: these are the labels on the traces, showing their detector (or their math mode).
4. Active Function annotation: this is the active function display in the meas bar, and all of the active function values displayed on softkeys.

See the figure below. Each type of annotation can be turned on and off individually.

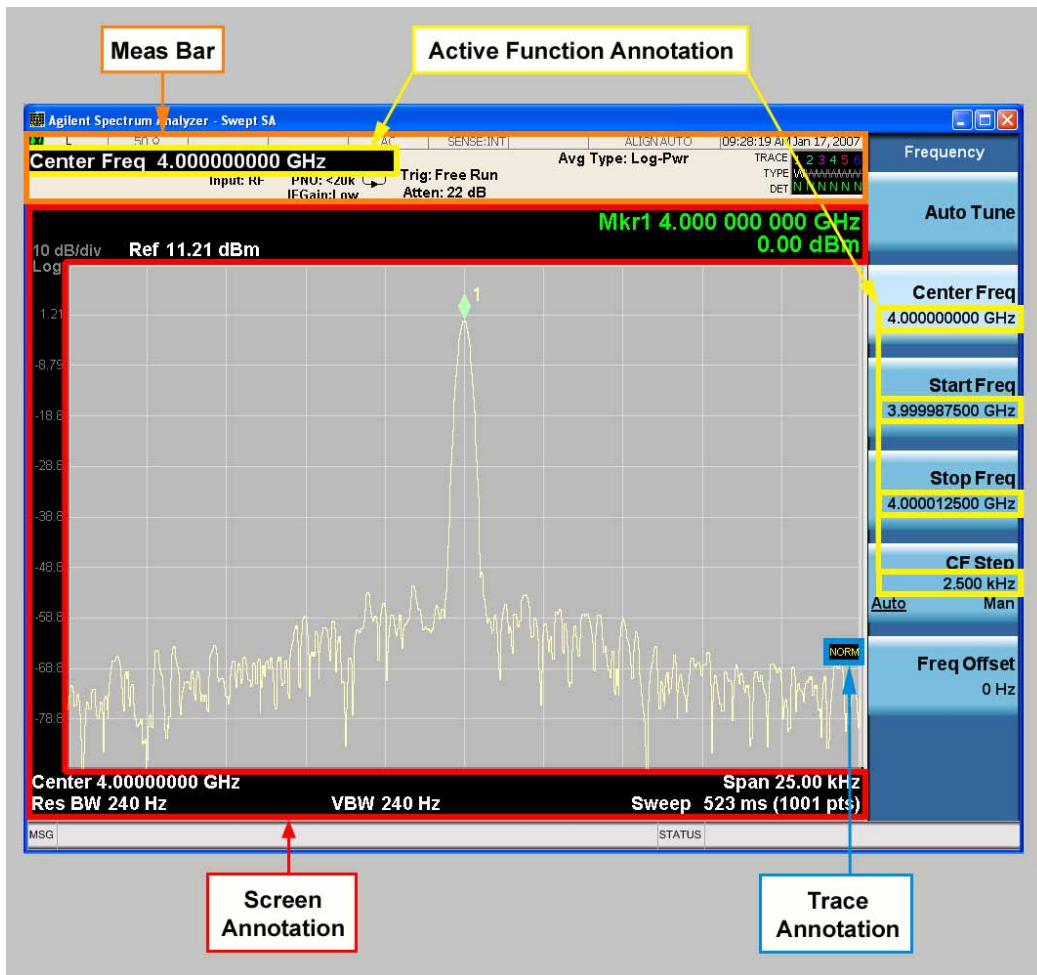

Key Path:	View/Display, Display
-----------	-----------------------

Common Measurement Functions 1

Initial S/W Revision:	Prior to A.02.00
-----------------------	------------------

Meas Bar On/Off

This function turns the Measurement Bar on and off, including the settings panel. When off, the graticule area expands to fill the area formerly occupied by the Measurement Bar.

Key Path:	View/Display, Display, Annotation
Remote Command:	:DISPlay:ANNotation:MBAR[:STATe] OFF ON 0 1 :DISPlay:ANNotation:MBAR[:STATe]?
Example:	DISP:ANN:MBAR OFF
Dependencies:	Grayed out and forced to OFF when System Display Settings, Annotation is set to Off.
Preset:	On This should remain Off through a Preset when System Display Settings, Annotation is set to Off.
State Saved:	Saved in instrument state.
Initial S/W Revision:	Prior to A.02.00

Screen

This controls the display of the annunciation and annotation around the graticule, including any annotation on lines (such as the display line, the threshold line, etc.) and the y-axis annotation. This does NOT include marker annotation (or the N dB result). When off, the graticule expands to fill the entire graticule area, leaving only the 1.5% gap above the graticule as described in the Trace/Detector chapter.

Key Path:	View/Display, Display, Annotation
Remote Command:	:DISPlay:ANNotation:SCREen[:STATe] OFF ON 0 1 :DISPlay:ANNotation:SCREen[:STATe]?
Example:	DISP:ANN:SCR OFF
Dependencies:	Grayed out and forced to OFF when System Display Settings, Annotation is set to Off.
Preset:	On This should remain Off through a Preset when System Display Settings, Annotation is set to Off
State Saved:	Saved in instrument state.
Initial S/W Revision:	Prior to A.02.00

Trace

Turns on and off the labels on the traces, showing their detector (or their math mode) as described in the Trace/Detector section.

If trace math is being performed with a trace, then the trace math annotation will replace the detector annotation.

Key Path:	View/Display, Display, Annotation
Remote Command:	:DISPlay:ANNOtation:TRACe[:STATe] ON OFF 1 0 :DISPlay:ANNOtation:TRACe[:STATe]?
Example:	DISP:ANN:TRAC OFF
Preset:	Off
State Saved:	Saved in instrument state.
Initial S/W Revision:	Prior to A.02.00

Active Function Values On/Off

Turns on and off the active function display in the Meas Bar, and all of the active function values displayed on the softkeys.

Note that all of the softkeys that have active functions have these numeric values blanked when this function is on. This is a security feature.

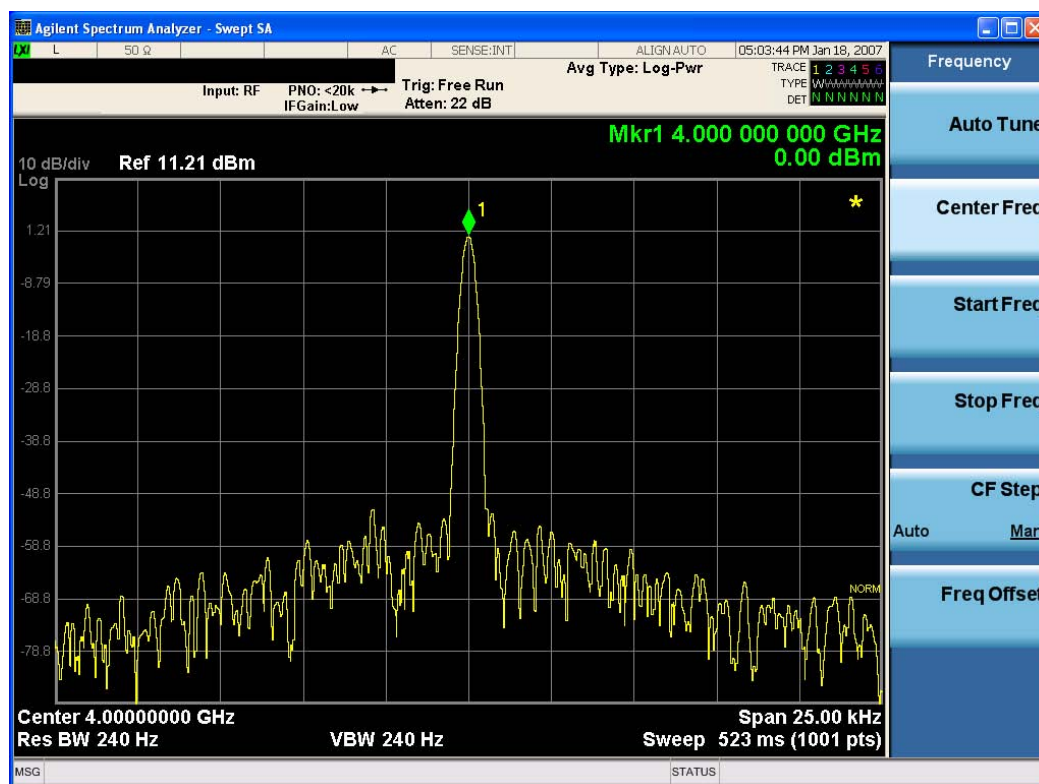

Key Path:	View/Display, Display, Annotation
Remote Command:	:DISPlay:ACTivefunc[:STATe] ON OFF 1 0 :DISPlay:ACTivefunc[:STATe]?
Example:	DISP:ACT OFF

Common Measurement Functions 1

Dependencies:	Grayed out and forced to OFF when System Display Settings, Annotation is set to Off.
Preset:	On This should remain Off through a Preset when System Display Settings, Annotation is set to Off
State Saved:	Saved in instrument state.
Initial S/W Revision:	Prior to A.02.00

Title

Displays menu keys that enable you to change or clear a title on your display.

Key Path:	View/Display, Display
Initial S/W Revision:	Prior to A.02.00

Change Title

Writes a title into the "measurement name" field in the banner, for example, "Swept SA".

Press Change Title to enter a new title through the alpha editor. Press Enter or Return to complete the entry. Press ESC to cancel the entry and preserve your existing title.

The display title will replace the measurement name. It remains for this measurement until you press **Change Title** again, or you recall a state, or a Preset is performed. A title can also be cleared by pressing **Title, Clear Title**.

NOTE	Notice the inclusion of the <measurement> parameter in the command below. Because each measurement remembers the Display Title, the command must be qualified with the measurement name. For the Swept SA measurement this is not the case; no <measurement> parameter is used when changing the Display Title for the Swept SA measurement.
-------------	--

Key Path:	View/Display, Display, Title
Mode:	All
Remote Command:	:DISPlay:<measurement>:ANNotation:TITLe:DATA <string> :DISPlay:<measurement>:ANNotation:TITLe:DATA?
Example:	DISP:ANN:TITL:DATA "This Is My Title" This example is for the Swept SA measurement in the Spectrum Analyzer mode. The SANalyzer <measurement> name is not used. DISP:ACP:ANN:TITL:DATA "This Is My Title" This example is for Measurements other than Swept SA. Both set the title to: This Is My Title

Notes:	Pressing this key cancels any active function. When a title is edited the previous title remains intact (it is not cleared) and the cursor goes at the end so that characters can be added or BKSP can be used to go back over previous characters.
Preset:	No title (measurement name instead)
State Saved:	Saved in instrument state.
Initial S/W Revision:	Prior to A.02.00

Clear Title

Clears a title from the front-panel display. Once cleared, the title cannot be retrieved. After the title is cleared, the current Measurement Name replaces it in the title bar.

Key Path:	View/Display, Display, Title
Example:	The following commands clear the title and restore the measurement's original title: DISP:ANN:TITL:DATA "" This example is for the Swept SA measurement in the Spectrum Analyzer mode. The SANalyzer <measurement> name is not used. DISP:ACP:ANN:TITL:DATA "" This example is for ACP; in measurements other than Swept SA the measurement name is required.
Notes:	Uses the :DISPlay:<measurement>:ANNotation:TITLe:DATA <string> command with an empty string (in the Swept SA, the <measurement> is omitted).
Preset:	Performed on Preset.
Initial S/W Revision:	Prior to A.02.00

Graticule

Pressing Graticule turns the display graticule On or Off. It also turns the graticule y-axis annotation on and off.

Key Path:	View/Display, Display
Remote Command:	:DISPlay:WINDow[1]:TRACe:GRATicule:GRID[:STATe] OFF ON 0 1 :DISPlay:WINDow[1]:TRACe:GRATicule:GRID[:STATe]?
Example:	DISP:WIND:TRAC:GRAT:GRID OFF
Notes:	The graticule is the set of horizontal and vertical lines that make up the grid/divisions for the x-axis and y-axis.
Preset:	On

Common Measurement Functions 1

State Saved:	saved in instrument state
Initial S/W Revision:	Prior to A.02.00

Display Line

Activates an adjustable horizontal line that is used as a visual reference line. The line's vertical position corresponds to its amplitude value. The value of the display line (for example, "-20.3 dBm") appears above the line itself on the right side of the display in the appropriate font.

The display line can be adjusted using the step keys, knob, or numeric keypad. The unit of the Display Line is determined by the **Y axis unit** setting under **Amplitude**. If more than one window has a display line, the display line of the selected window is controlled.

If the display line is off the screen, it shows as a line at the top/bottom of the screen with an arrow pointing up or down. As with all such lines (Pk Thresh, Trigger Level, etc.) it is drawn on top of all traces.

The display line is unaffected by Auto Couple.

Key Path:	View/Display, Display
Remote Command:	:DISPlay:WINDow[1]:TRACe:Y:DLINe <amp;l> :DISPlay:WINDow[1]:TRACe:Y:DLINe? :DISPlay:WINDow[1]:TRACe:Y:DLINe:STATe OFF ON 0 1 :DISPlay:WINDow[1]:TRACe:Y:DLINe:STATe?
Example:	DISP:WIND:TRAC:Y:DLIN:STAT ON DISP:WIND:TRAC:Y:DLIN:STAT -32 dBm
Preset:	Set the Display Line to Off and -25 dBm on Preset. When the Display Line goes from Off to On, if it is off screen, set it to either the top or bottom of screen, depending on which direction off screen it was. The Display Line's value does not change when it is turned off.
State Saved:	Saved in instrument state.
Min:	$-\infty$ (minus infinity) in current units
Max:	$+\infty$ (plus infinity) in current units
Default Unit:	Depends on the current selected Y axis unit
Initial S/W Revision:	Prior to A.02.00

System Display Settings

These settings are "Mode Global" – they affect all modes and measurements and are reset only by **Restore Misc Defaults** or **Restore System Defaults** under System.

Key Path:	View/Display, Display
Initial S/W Revision:	Prior to A.02.00

Annotation Local Settings

This is a Mode Global override of the meas local annotation settings. When it is **All Off**, it forces **Screen Annotation, Meas Bar, Trace, and Active Function Values** settings to be **OFF** for all measurements in all modes. This provides the security based "annotation off" function of previous analyzers; hence it uses the legacy SCPI command.

When it is **All Off**, the **Screen, Meas Bar, Trace, and Active Function Values** keys under the **Display, Annotation** menu are grayed out and forced to **Off**. When **Local Settings** is selected, you are able to set the local annotation settings on a measurement by measurement basis.

Key Path:	View/Display, Display, System Display Settings
Remote Command:	:DISPlay:WINDow[1]:ANNotation[:ALL] OFF ON 0 1 :DISPlay:WINDow[1]:ANNotation[:ALL]?
Example:	:DISP:WIND:ANN OFF
Preset:	On (Set by Restore Misc Defaults)
State Saved:	Not saved in instrument state.
Backwards Compatibility Notes:	The WINDow parameter and optional subopcode is included for backwards compatibility but ignored – all windows are equally affected.
Initial S/W Revision:	Prior to A.02.00

Theme

This key allows you to change the Display theme. This is similar to the Themes selection under Page Setup and Save Screen Image. The four themes are detailed below.

Key Path:	View/Display, Display, System Display Settings
Remote Command:	:DISPlay:THEME TDColor TDMonochrome FCOLor FMONochrome :DISPlay:THEMe?
Example:	DISP:THEM TDM sets the display theme to 3D Monochrome.
Notes:	TDColor – 3D is the standard color theme with filling and shading TDMonochrome – is similar to 3D color, but only black is used FCOLor – flat color is intended for inkjet printers to conserve ink. It uses a white background instead of black. FMONochrome – is like flat color, but only black is used
Preset:	TDColor (Set by Restore Misc Defaults)
State Saved:	Not saved in instrument state.
Initial S/W Revision:	Prior to A.02.00

Backlight

Accesses the display backlight on/off keys. This setting may interact with settings under the Windows "Power" menu.

Common Measurement Functions 1

When the backlight is off, pressing ESC, TAB, SPACE, ENTER, UP, DOWN, LEFT, RIGHT, DEL, BKSP, CTRL, or ALT turns the backlight on without affecting the application. Pressing any other key will turn backlight on and could potentially perform the action as well.

Key Path:	View/Display, Display, System Display Settings
Remote Command:	:DISPlay:BACKlight ON OFF :DISPlay:BACKlight?
Preset:	ON (Set by Restore Misc Defaults)
Initial S/W Revision:	Prior to A.02.00

On

Turns the display backlight on.

Key Path:	View/Display, Display, System Display Settings, Backlight
Example:	DISP:BACK ON
Readback:	On
Initial S/W Revision:	Prior to A.02.00

Off

Turns the display backlight off.

Key Path:	View/Display, Display, System Display Settings, Backlight
Example:	DISP:BACK OFF
Readback:	Off
Initial S/W Revision:	Prior to A.02.00

Backlight Intensity

An active function used to set the backlight intensity. It goes from 0 to 100 where 100 is full on and 0 is off. This value is independent of the values set under the Backlight on/off key.

Key Path:	View/Display, Display, System Display Settings
Remote Command:	:DISPlay:BACKlight:INTensity <integer> :DISPlay:BACKlight:INTensity?
Example:	DISP:BACK:INT 50
Preset:	100 (Set by Restore Misc Defaults)
Min:	0
Max:	100
Initial S/W Revision:	Prior to A.02.00

Full Screen

When **Full Screen** is pressed the measurement window expands horizontally over the entire instrument display. The screen graticule area expands to fill the available display area.

It turns off the display of the softkey labels, however the menus and active functions still work. (Though it would obviously be very hard to navigate without the key labels displayed.) Pressing **Full Screen** again while Full Screen is in effect cancels Full Screen.

Note that the banner and status lines are unaffected. You can get even more screen area for your data display by turning off the Meas Bar (in the Display menu) which also turns off the settings panel.

Full Screen is a Meas Global function. Therefore it is cancelled by the **Preset** key.

Key Path:	Display
Remote Command:	:DISPlay:FSCreen[:STATe] OFF ON 0 1 :DISPlay:FSCreen[:STATe]?
Preset:	Off
State Saved:	Not saved in instrument state.
Backwards Compatibility SCPI:	:DISPlay:MENU[:STATe] OFF ON 0 1 This emulates ESA full screen functionality, which is the same as the FSCreen command in PSA except that the sense of on/off is reversed (that is, OFF means the menus are OFF, so Fullscreen is ON) and the default is ON (meaning Fullscreen is OFF).
Backwards Compatibility Notes:	In ESA/PSA, Full Screen was turned on with a softkey, so pressing any other key turned Full Screen off. In the X-Series, because a hardkey is provided to turn this function on and off, pressing any other key no longer turns off Full Screen
Initial S/W Revision:	Prior to A.02.00

Display Enable (Remote Command Only)

Turns the display on/off, including the display drive circuitry. The backlight stays lit so you can tell that the instrument is on. The display enable setting is mode global. The reasons for turning the display off are three:

- To increase speed as much as possible by freeing the instrument from having to update the display
- To reduce emissions from the display, drive circuitry
- For security purposes

If you have turned off the display:

- and you are in local operation, the display can be turned back on by pressing any key or by sending the SYSTem:DEFaults MISC command or the DISPlay:ENABle ON (neither *RST nor SYSTem:PRESet enable the display.)
- and you are in remote operation, the display can be turned back on by pressing the **Local** or **Esc** keys or by sending the SYSTem:DEFaults MISC command or the DISPlay:ENABle ON (neither *RST

Common Measurement Functions 1

nor SYSTem:PRESet enable the display.)

and you are using either the SYSTem:KLOCK command or GPIB local lockout, then no front-panel key press will turn the display back on. You must turn it back on remotely.

Remote Command:	:DISPlay:ENABle OFF ON 0 1 :DISPlay:ENABle?
Example:	DISP:ENAB OFF
Couplings:	DISP:ENAB OFF turns Backlight OFF and DISP:ENAB ON turns Backlight ON. However, settings of Backlight do not change the state of DISP:ENAB
Preset:	On Set by SYST:DEF MISC, but Not affected by *RST or SYSTem:PRESet.
State Saved:	Not saved in instrument state.
Backwards Compatibility Notes:	SYST:PRES no longer turns on DISPlay:ENABle as it did in legacy analyzers
Initial S/W Revision:	Prior to A.02.00

Common Measurement Functions 2

The key and command descriptions in this section describe functions that operate identically in multiple measurements and/or modes. This section is a library of functions that is referenced by many measurements and modes

To find the exact description and parameters for functions in a specific measurement, always look in the measurement section of this documentation. Pressing the front-panel key or softkey and then pressing the green Help key also provides the correct information.

NOTE If you want to print the documentation, be sure to select this section and the measurement of interest to ensure having all the information you need. See [“Printing Acrobat Files” on page 141](#) for further instructions about printing.

AMPTD Y Scale (Amplitude)

This menu has controls for the input signal conditioning as well as the Y-scaling of trace data. Input signal conditioning actually affect the input signal and the associated measurement quality, whereas Y-scaling is non-destructive of data. Even if the data is scaled so as to be clipped or completely off the display, the marker readouts are still correct and accurate data may still be retrieved via SCPI.

Key Path	Front Panel
Initial S/W Revision	Prior to A.02.00

Range

The Range setting represents the amplitude of the largest sinusoidal signal that could be present within the IF without being clipped by the ADC. For signals with high peak-to-rms ratios, the range may need to exceed the rms signal power by a fair amount to avoid clipping.

Key Path	AMPTD/YScale
Mode	VSA, LTE, LTETDD, IDEN
Remote Command	[:SENSE] :POWER [:RF] :RANGe <real> [:SENSE] :POWER [:RF] :RANGe?
Example	POW:RANG 25 POW:RANG?
Notes	The parameter is interpreted as dBm
Preset	20
State Saved	Saved in instrument state.
Min	depends on model and preamp options

Common Measurement Functions 2

Max	depends on model and preamp options
Initial S/W Revision	Prior to A.02.00
Modified at S/W Revision	A.02.00

Y Axis Scaling

Y axis scaling allows you to view the entire range of the data or zoom in on a range of interest. Scaling does not affect measurement setup, and rescaling can be done at any time on paused or complete measurements and the results of the rescaling are immediately visible. Y scaling can be made to track range setting for convenience in setting up measurements.

Key Path	AMPTD Y-Scale
Mode	VSA, LTE, LTETDD, IDEN
Initial S/W Revision	Prior to A.02.00
Modified at S/W Revision	A.02.00

Select Trace

This function is a duplicate of the same function found on the Trace/Detector menu. The Select Trace key is also located here to allow you to conveniently choose which trace the Y scaling applies.

See [“Select Trace” on page 1728](#) for details.

Key Path	AMPTD Y-Scale, Y Axis Scaling
Mode	VSA, LTE, LTETDD, IDEN
Initial S/W Revision	Prior to A.02.00
Modified at S/W Revision	A.02.00

Y Auto Scale

This immediate action key causes the Y reference value and Scale per Division to change so as to display the full trace without clipping.

Key Path	AMPTD/YScale
Mode	VSA, LTE, LTETDD, IDEN
Measurement	<meas>:=VECTor ADEMod DDEMod W11A W11B EVM IPOWER IDEMod MOTotalk
Remote Command	:DISPlay:<meas>:TRACe[1] 2 3 4 : Y [: SCALe] : AUTO : ONCE
Example	:DISP:VECT:TRAC1:Y:AUTO:ONCE
Initial S/W Revision	Prior to A.02.00
Modified at S/W Revision	A.02.00

Y Reference Value

This function controls the Y value of the selected trace at the Reference Position. It has no effect on hardware input settings.

See “Y Reference: Position” on page 1660 for more details.

Key Path	AMPTD/YScale
Mode	VSA, LTE, LTETDD, IDEN
Measurement	<meas>:=VECTor ADEMod DDEMod W11A W11B EVM IPOWER IDEMod MOTotalk
Remote Command	:DISPlay:<meas>:TRACe[1] 2 3 4:Y[:SCALE]:RLEVel <real> :DISPlay:<meas>:TRACe[1] 2 3 4:Y[:SCALE]:RLEVel?
Example	DISP:VECT:TRAC:Y:RLEV 20 DISP:VECT:TRAC:Y:RLEV?
Couplings	None. This does not affect any hardware input settings.
Preset	Depends on trace
State Saved	Saved in instrument state.
Min	-9.9E+37
Max	9.9E+37
Initial S/W Revision	Prior to A.02.00
Modified at S/W Revision	A.02.00

Y Scale Per Division

This controls the Y scale per division of the selected trace.

Key Path	AMPTD/YScale
Mode	VSA, LTE, LTETDD, IDEN
Measurement	<meas>:=VECTor ADEMod DDEMod W11A W11B EVM IPOWER IDEMod MOTotalk
Remote Command	:DISPlay:<meas>:TRACe[1] 2 3 4:Y[:SCALE]:PDIVision <real> :DISPlay:<meas>:TRACe[1] 2 3 4:Y[:SCALE]:PDIVision?
Example	DISP:VECT:TRAC:Y:PDIV 10 DISP:VECT:TRAC:Y:PDIV?
Couplings	None.
Preset	Depends on trace
State Saved	Saved in instrument state.

Common Measurement Functions 2

Min	-9.9E+37
Max	9.9E+37
Initial S/W Revision	Prior to A.02.00
Modified at S/W Revision	A.02.00

Couple Ref to Range

When Couple Ref to Range is on, a Y scaling is adjusted when the Range changes. For example, on traces with Y units of dBm, the reference value changes by the same amount in dB as the Range does. On a trace with Y units of Volts, the Per Division setting changes by a factor of approx. 1.25 when the Range changes by 2 dB. This function may be turned on or off on for each individual trace.

Key Path	AMPTD/YScale
Mode	VSA, LTE, LTETDD, IDEN
Measurement	<meas>:=VECTor ADEMod DDEMod W11A W11B EVM IPOWer IDEMod MOTotalk
Remote Command	:DISPlay:<meas>:TRACe[1] 2 3 4:Y[:SCALE]:RLEVel:AUTO OFF ON 0 1 :DISPlay:<meas>:TRACe[1] 2 3 4:Y[:SCALE]:RLEVel:AUTO?
Example	DISP:VECT:TRAC1:Y:RLEV:AUTO ON DISP:VECT:TRAC1:Y:RLEV:AUTO?
Notes	Range coupling is not available for Phase and Group delay traces.
Preset	1
State Saved	Saved in instrument state.
Range	On Off
Initial S/W Revision	Prior to A.02.00
Modified at S/W Revision	A.02.00

Y Reference: Position

This determines the position of the reference line for Y scaling for the selected trace. It may be set to the top, bottom, or center of the grid.

Key Path	AMPTD/YScale
Mode	VSA, LTE, LTETDD, IDEN
Measurement	<meas>:=VECTor ADEMod DDEMod W11A W11B EVM IPOWer IDEMod MOTotalk

Remote Command	:DISPlay:<meas>:TRACe[1] 2 3 4:Y[:SCALE]:RPOStion TOP CENTer BOTTom :DISPlay:<meas>:TRACe[1] 2 3 4:Y[:SCALE]:RPOStion?
Example	DISP:VECT:TRAC1:Y:RPOS TOP DISP:VECT:TRAC1:Y:RPOS?
Couplings	Changing trace format or data can affect this. Each format "remembers" its reference position.
Preset	Depends on trace format and trace data. Top for LogMag or most LinearMag traces, middle for Real, Imaginary, Vector displays, Eye diagrams, Phase, Delay, Bottom for Linear Mag EVM
State Saved	Saved in instrument state.
Range	Top Ctr Bottom
Initial S/W Revision	Prior to A.02.00
Modified at S/W Revision	A.02.00

Y Unit Preference

This determines the preferred Y unit for the selected trace. You can select Peak, RMS, Power units, or an automatic selection. The automatic selection is to show Power units for frequency domain data and Peak units for time domain data.

Key Path	AMPTD/YScale
Mode	VSA, LTE, LTETDD, IDEN
Measurement	<meas>:=VECTor ADEMod DDEMod W11A W11B EVM IPOWER IDEMod MOTotalk
Remote Command	:DISPlay:<meas>:TRACe[1] 2 3 4:Y:UNIT:PREFerece AUTO PEAK RMS POWer MRMS :DISPlay:<meas>:TRACe[1] 2 3 4:Y:UNIT:PREFerece?
Example	DISP:VECT:TRAC1:Y:UNIT:PREF PEAK DISP:VECT:TRAC1:Y:UNIT:PREF?
Preset	AUTO
State Saved	Saved in instrument state.
Range	AUTO PEAK RMS POW MRMS
Readback Text	Auto Peak RMS Power mRMS
Initial S/W Revision	Prior to A.02.00
Modified at S/W Revision	A.02.00

The following SCPI only command can be used to determine exactly which Y unit was chosen based on

Common Measurement Functions 2

the setting of the above:

Key Path	AMPTD/YScale
Mode	VSA, LTE, LTETDD, IDEN
Measurement	<meas>:=VECTor ADEMod DDEMod W11A W11B EVM IPOWer IDEMod MOTotalk
Remote Command	:DISPlay:<meas>:TRACe[1] 2 3 4:Y:UNIT?
Example	DISP:VECT:TRAC1:Y:UNIT?
Initial S/W Revision	Prior to A.02.00
Modified at S/W Revision	A.02.00

Y Log Ratio

This property is only used if the Trace Format is set to LogMag (Linear Unit). In this format type, you set the Y Log Ratio instead of Y Scale Per Division to determine Y scaling. It sets the ratio of the top of the Y axis to the bottom.

Key Path	AMPTD/YScale
Mode	VSA, LTE, LTETDD, IDEN
Measurement	<meas>:=VECTor ADEMod DDEMod W11A W11B EVM IPOWer IDEMod MOTotalk
Remote Command	:DISPlay:<meas>:TRACe[1] 2 3 4:Y:LRATio <real> :DISPlay:<meas>:TRACe[1] 2 3 4:Y:LRATio?
Example	DISP:VECT:TRAC1:Y:LRAT 10000 DISP:VECT:TRAC1:Y:LRAT?
Notes	This is grayed out if the trace format is not Log Mag (linear unit).
Preset	100000
State Saved	Saved in instrument state.
Min	1.001
Max	100e6
Initial S/W Revision	Prior to A.02.00
Modified at S/W Revision	A.02.00

Vector Horiz Center

The Vector trace formats are I-Q and Constellation. When you are in one of these formats you set the vertical (imaginary) axis scaling with the Y Reference Value, Y Reference Position, and Y Scale Per Division properties. The scaling of the horizontal axis is set so as to maintain an aspect ratio of 1:1. The

Vector Horiz Center property is used to set the position of the origin.

Key Path	AMPTD/YScale
Mode	VSA, LTE, LTETDD, IDEN
Measurement	<meas>:=VECTor ADEMod DDEMod W11A W11B EVM IPOWER IDEMod MOTotalk
Remote Command	:DISPlay:<meas>:TRACe[1] 2 3 4:VHCenter <real> :DISPlay:<meas>:TRACe[1] 2 3 4:VHCenter?
Example	DISP:DDEM:TRAC1:VHC 0.2 DISP:DDEM:TRAC1:VHC?
Preset	0
State Saved	Saved in instrument state.
Min	-9.9e37
Max	9.9e37
Initial S/W Revision	Prior to A.02.00
Modified at S/W Revision	A.02.00

Copy Y Scale

This front-panel only function copies the following Y scaling information from the selected trace to another:

- Y reference Position
- Y Reference Value
- Y Unit Preference
- Vector Horiz Center
- Couple Ref to Range
- Y Log Ratio
- Y Reference Line

Key Path	AMPTD Y-Scale, Y Axis Scaling
Mode	VSA, LTE, LTETDD, IDEN
Initial S/W Revision	Prior to A.02.00
Modified at S/W Revision	A.02.00

Common Measurement Functions 2

Reference Line

This controls whether the Y reference line is visible or not.

Key Path	AMPTD/YScale
Mode	VSA, LTE, LTETDD, IDEN
Measurement	<meas>:=VECTor ADEMod DDEMod W11A W11B EVM IPOWer IDEMod MOTotalk
Remote Command	:DISPly:<meas>:TRACe[1] 2 3 4:RLINe OFF ON 0 1 :DISPly:<meas>:TRACe[1] 2 3 4:RLINe?
Example	DISP:VECT:TRAC1:RLIN ON DISP:VECT:TRAC1:RLIN?
Preset	OFF
State Saved	Saved in instrument state.
Initial S/W Revision	Prior to A.02.00
Modified at S/W Revision	A.02.00

BW (Bandwidth)

The BW key allows you to control the resolution bandwidth of the spectrum measurement result, as well as the shape of the resolution bandwidth filter (controlled by the FFT windowing function).

Key Path	Front Panel
Mode	VSA, LTE, LTETDD, IDEN
Initial S/W Revision	Prior to A.02.00
Modified at S/W Revision	A.02.00

Res BW

This key allows you to select the resolution bandwidth of the measurement. Res BW is mathematically related to Time length and Window type, so changing one of these, directly or indirectly, must change at least one other.

Res BW and Time length are related by the following equation:

$$\text{Res BW} = \text{ENBW} / T$$

where:

ENBW is the normalized effective noise bandwidth of the Window. See [“FFT Window” on page 1667](#) for more details).

T is the time record length.

Therefore, **if you change Res BW, Main Time must also change**, and vice versa. (If the Gate function is on, then it is Gate Length, not Main Time, that is related to Res BW by the above equation.)

For convenience, Res BW is by default also coupled to Span (but not vice versa). This coupling may be turned off. See “Res BW Coupling” on page 1665 for more details.

Limits:

The minimum Res BW to Span ratio is related to the maximum Main Time length, and is given by:

- ENBW / 409600 if Freq points state parameter is set to Auto
- ENBW / (Freq Points – 1) if Freq points parameter is manually set

The maximum Res BW to Span ratio is related to the minimum time record size (16 points for most windows, 17 points for Flat Top), and is given by:

ENBW / 12.5
 (ENBW / 13.28125 for Flat Top window)

See the “Main Time” on page 1734 topic for more on relationships between Res BW and time.

Key Path	BW
Mode	VSA
Measurement	<meas>:=VECTor ADEMod IPOWER IDEMod MOTotalk
Remote Command	[:SENSE] : <meas> : BANDwidth BWIDth [:RESolution] <bandwidth> [:SENSE] : <meas> : BANDwidth BWIDth [:RESolution] ?
Example	VECT:BWID 200 KHZ VECT:BWID?
Notes	Key blanked in any other measurement than Vector or Analog Demod
Couplings	Changing Main Time or Gate Length changes Res BW. See Res BW Coupling for other changes that can affect (or be affected by) Res BW
Preset	300 kHz
State Saved	Saved in instrument state.
Min	-9.9e37
Max	9.9e37
Initial S/W Revision	Prior to A.02.00
Modified at S/W Revision	A.02.00

Res BW Coupling

This property controls how Res BW is affected by other parameters. The three possible settings are:

- Span: (default) This setting keeps the ratio of Res BW:Span constant whenever the Span is changed. However, you can change the Res BW at will, and doing so establishes a new Res BW:Span ratio.

Common Measurement Functions 2

Min: This setting is only available when the Freq Points property is manually set, and is disabled (forceful grey out) when Freq Points is Auto. It maintains the RBW at the minimum possible value given the settings for Freq Points, Span, and Window. Res BW coupling is changed from Min to Span if you manually set Res BW.

Fixed: This setting attempts to keep the Res BW setting fixed as Span, Freq Points, or FFT Window type change. Changing FFT Window will cause Main Time (or Gate) length to change in order to keep the Res BW Fixed. Res BW coupling is forced to Fixed mode any time you turn the Gate function on or manually set Main Time length. See “Main Time” on page 1734 for details.

If a requested change to Res BW or Time Length (Main or Gate) would cause the Res BW to go outside the minimum or maximum Res BW: Span limits (see the main Res BW section for specifics), the Res BW is clipped at the appropriate limit. The Time length is then set to according to the limited Res BW.

In Fixed coupling mode, if increasing the Span would cause the new Res BW:Span to drop below the minimum, or if decreasing Span would cause the new Res BW: span to exceed the maximum, the requested Span is accepted and then the Res BW is changed to the limiting value. The associated Time length is updated.

In Fixed or Span coupling, increasing Freq Points does not cause the Main (or Gate) Time Length to increase. It only adds zero padding to the array that is used in the FFT to calculate the Spectrum. Therefore, it will not affect Res BW. If decreasing Freq Points decreases the maximum time length below the current Main Time, then the Main Time length is clipped to the new limits. If Gating is on, the Gate Delay is first limited, then the Gate Length. The Res BW is then updated as a result of the Time changes.

In Fixed or Span coupling, changing the Window Type will not affect RBW unless it falls outside the limits calculated using the new window. Then the Res BW is clipped at the appropriate limit. The associated Time length is also updated.

Key Path	BW
Mode	VSA
Measurement	<meas>:=VECTor ADEMod IPOWER IDEMod MOTotalk
Remote Command	[:SENSe] : <meas> : BANDwidth BWIDth [:RESolution] : COUPle SPAN MIN FIXed [:SENSe] : <meas> : BANDwidth BWIDth [:RESolution] : COUPle?
Example	VECT:BWID:COUP FIX VECT:BWID:COUP?
Notes	Blanked when in any other measurement than Vector or Analog Demod MIN is not available if Freq Points is set to Auto and trying to set it generates error -221 Settings conflict
Couplings	See narrative above table and also Res BW section
Preset	SPAN
State Saved	Saved in instrument state.
Range	Span Min Fixed

Initial S/W Revision	Prior to A.02.00
Modified at S/W Revision	A.02.00

FFT Window

This key allows you to choose the Window function that is applied to the time data prior to the FFT calculation used for Spectrum and PSD displays. Four windows are available.

Window name	Common usage	Normalized ENBW (Hz-s)
Uniform	Transient or self-windowing signals, signals that are periodic within a time record length.	1.0
Hanning	Frequency resolution	1.5
Gaussian	High dynamic range	2.21536
Flat Top	High amplitude accuracy	3.8194

The normalized ENBW is the equivalent noise bandwidth, that is, the width of a rectangular filter that passes the same amount of white noise as the window. It is used to define the resolution bandwidth.

Key Path	BW
Mode	VSA, LTE, LTETDD, IDEN
Measurement	<meas>:=VECTor ADEMod DDEMod W11A W11B EVM IPOWER IDEMod MOTotalk
Remote Command	[:SENSE] : <meas> : FFT : WINDow [:TYPE] UNIFORM HANNING GAUSSIAN FLATtop [:SENSE] : <meas> : FFT : WINDow [:TYPE] ?
Example	VECT:FFT:WIND GAUS VECT:FFT:WIND?
Couplings	See Res BW and Res BW Coupling sections
Preset	FLAT
State Saved	Saved in instrument state.
Range	Uniform Hanning Gaussian (High Dyn Rng) Flat Top (High Amptd Accy)
Readback Text	Uniform Hanning Gaussian Flat Top
Initial S/W Revision	Prior to A.02.00
Modified at S/W Revision	A.02.00

FREQ Channel

Frequency parameters for any vector measurement consist of 2 pairs of properties: Center Frequency and

Common Measurement Functions 2

Span or Start Frequency and Stop Frequency. These behave much as they do in any other application, but there is the additional constraint that the span is limited to much less than the center frequency range.

If you change center frequency the start and stop frequencies change by the same amount.

If you change span, start frequency and stop frequency are changed by 1/2 the span change.

If you change start frequency, stop frequency remains fixed and span and center frequency are refigured accordingly. Changing stop frequency has similar behavior.

Limits:

If you change the start frequency such that it will equal or exceed the stop frequency, the new start frequency will be accepted if possible and the stop frequency will be set to min span above the start. Similarly if you attempt to set the stop below the start, the start frequency will move to a min span below the new stop frequency.

If you reduce the start frequency beyond a max span below the stop, the stop frequency will be "dragged along" such that it will be a max span above the new start frequency, and similarly increasing the stop frequency will drag the start frequency along if you attempt to increase the span beyond the maximum.

Stop frequency may be 1/2 span above the maximum center frequency, but frequency-domain traces are blanked above the maximum center frequency.

Start frequency may be 1/2 span below the minimum center frequency, but frequency-domain traces are blanked below the minimum center frequency.

Pressing the Freq hardkey changes the active function to Center Frequency.

Key Path	Front Panel
Mode	VSA, LTE, LTETDD, IDEN
Initial S/W Revision	Prior to A.02.00
Modified at S/W Revision	A.02.00

Center Freq

Sets the frequency of the display Center.

Key Path	FREQ Channel
Mode	VSA, LTE, LTETDD, IDEN
Remote Command	[:SENSE] :FREQuency:CENTer <freq> [:SENSE] :FREQuency:CENTer?
Example	FREQ:CENT 985 MHZ FREQ:CENT?
Couplings	Start Freq, Stop Freq, and Span. See " FREQ Channel " on page 1667 for more details.
Preset	1 GHz

State Saved	Saved in instrument state.
Min	0 Hz
Max	Depends on frequency range option.
Initial S/W Revision	Prior to A.02.00
Modified at S/W Revision	A.02.00

Start Freq

Sets the frequency of the display Start.

Key Path	FREQ Channel
Mode	VSA, IDEN
Remote Command	[:SENSe] :FREQuency :STARt <freq> [:SENSe] :FREQuency :STARt?
Example	FREQ:STAR 980 MHz FREQ:STAR?
Couplings	Stop Freq, Center Freq, and Span. See “FREQ Channel” on page 1667 for more details.
Preset	Depends on span option. It is 1/2 max span below 1 GHz
State Saved	Saved in instrument state.
Min	-9.9e37
Max	9.9e37
Initial S/W Revision	Prior to A.02.00
Modified at S/W Revision	A.02.00

Stop Freq

Sets the frequency of the display Stop.

Key Path	FREQ Channel
Mode	VSA, IDEN
Remote Command	[:SENSe] :FREQuency :STOP <freq> [:SENSe] :FREQuency :STOP?
Example	FREQ:STOP 990 MHz FREQ:STOP?
Couplings	Start Freq, Center Freq, and Span. See “FREQ Channel” on page 1667 for more details.

Common Measurement Functions 2

Preset	Depends on span option. It is 1/2 max span above 1 GHz
State Saved	Saved in instrument state.
Min	-9.9e37
Max	9.9e37
Initial S/W Revision	Prior to A.02.00
Modified at S/W Revision	A.02.00

CF Step

This key controls the amount the center frequency changes if it is the active function and the user presses the Up or Down arrow key. Note: the start and stop frequency also change by the amount of the CF Step if the Up/Down arrow keys are used to change them; but the key is mainly used in connection with stepping the center frequency, so the legacy key name has been retained. The step size in Auto mode is 1/10th the span. It can be set to any value in manual mode.

Key Path	FREQ Channel
Mode	VSA, LTE, LTETDD, IDEN
Remote Command	[:SENSE] :FREQuency:CENTer:STEP[:INCRement] <freq> [:SENSE] :FREQuency:CENTer:STEP[:INCRement]? [:SENSE] :FREQuency:CENTer:STEP:AUTO OFF ON 0 1 [:SENSE] :FREQuency:CENTer:STEP:AUTO?
Example	FREQ:CENT:STEP 1 MHZ FREQ:CENT:STEP? FREQ:CENT:STEP:AUTO ON FREQ:CENT:STEP:AUTO?
Couplings	1/10th Span when auto is turned on
Preset	Depends on span option; 1/10th default span.
State Saved	Saved in instrument state.
Min	-9.9e37
Max	9.9e37
Initial S/W Revision	Prior to A.02.00
Modified at S/W Revision	A.02.00

Marker

The Marker hardkey displays the Marker menu. A marker can be placed on a trace to allow the value of the trace data at the marker position to be determined precisely. Markers can also be used in pairs to read the difference (or delta) between two data points. They can also be used to make power calculations over

a band of frequencies or a time interval. See Marker Functions below for more details.

The functions in this menu include a 1-of-N selection of the control mode **Normal**, **Delta**, **Fixed**, or **Off** for the selected marker. The control mode is described below.

Pressing **Marker** always makes the selected maker's X position the active function.

If the currently selected marker is **Off**, pressing **Marker** sets it to **Normal** mode and places it at the center of the screen on the currently selected trace.

As a convenience, if there are no markers displayed on the current trace, pressing the marker hardkey (whenever the marker menu is already showing) selects the lowest numbered marker that is currently off and turns it on in normal mode on the selected trace. In other words, pressing the Marker hardkey twice will always turn on a marker on the selected trace if none was turned on before.

For more information see the Analyzer Setup, Marker for a description of this function.

Key Path	Front Panel
Mode	VSA, LTE, LTETDD, IDEN
Initial S/W Revision	Prior to A.02.00
Modified at S/W Revision	A.02.00

Select Marker

Specifies the selected marker. The selected marker is the one that is affected by the marker position and properties settings, peak search, and other marker functions. Several menus have a Select Marker key for convenience. Marker selection using any one of these is reflected in all others, i.e., there is only one selected marker for the whole measurement. If all markers are off, then marker 1 becomes the selected marker.

As a convenience, if no markers are displayed on the selected trace, selecting a marker that is off automatically turns it on in normal mode on the selected trace.

There is no SCPI function for selecting a marker. Instead, SCPI functions may explicitly include the index of the marker for which they are to apply. (Most SCPI marker functions that affect the state of a marker will also make it the selected marker for front panel commands.)

Key Path	Marker or Marker> or Marker Function
Mode	VSA, LTE, LTETDD, IDEN
State Saved	No
Range	1 2 3 4 5 6 7 8 9 10 11 12
Initial S/W Revision	Prior to A.02.00
Modified at S/W Revision	A.02.00

Control Mode

The control mode of the selected marker is selected by pressing **Normal**, **Delta**, **Fixed**, or **Off**. The behavior of a marker under each control mode is described below the table. The current control mode is

Common Measurement Functions 2

shown by highlighting the appropriate key.

The SCPI command in the table below selects the marker and sets the marker control mode as described under Normal, Delta, Fixed and Off, below. All interactions and dependencies detailed under the key description are enforced when the remote command is sent.

Key Path	Marker
Mode	VSA, LTE, LTETDD, IDEN
Measurement	<meas>:=VECTor ADEMod DDEMod W11A W11B EVM IPOWer IDEMod MOTotalk
Remote Command	:CALCulate:<meas>:MARKer[1] 2 3 4 5 6 7 8 9 10 11 12: MODE POSition DELTA FIXed =OFF :CALCulate:<meas>:MARKer[1] 2 3 4 5 6 7 8 9 10 11 12: MODE?
Example	CALC:VECT:MARK1:MODE POS CALC:VECT:MARK1:MODE?
Couplings	When Delta mode is selected, or when the mode is changed from Delta to Off, the marker relative to the selected marker may be affected, as described in the text descriptions below.
Preset	=OFF
State Saved	Saved in instrument state.
Range	Normal Delta Fixed Off
Initial S/W Revision	Prior to A.02.00
Modified at S/W Revision	A.02.00

Normal (Position)

A marker in normal mode reports the trace data value (Y value) at a particular point on a trace. The marker's absolute X (and Z) position is specified by you in displayed units. The marker symbol appears on the trace at the specified position and tracks the absolute Y value at that position as it changes from scan to scan. The absolute Y value is displayed in the marker readout area. In older instruments this was called Position mode, and the designation may still be used for backward compatibility.

For Control Mode SCPI command information see: [“Control Mode” on page 1671](#)

Key Path	Marker
Mode	VSA, LTE, LTETDD, IDEN
Initial S/W Revision	Prior to A.02.00
Modified at S/W Revision	A.02.00

Delta

A marker set to delta mode reports the difference between Y values at two points. A delta marker is

relative to an associated reference marker on the same trace. (The reference marker may be set on the Marker, Properties, Relative To menu). The reference marker is usually fixed, but may also be normal or delta. The X (and Z) position of a delta marker is specified as an offset from the reference marker position. The delta marker symbol tracks the absolute Y value just like a normal marker, but the marker readout displays the difference between the absolute Y values of the delta marker and its reference marker (absolute units are used even if the reference is itself a delta marker). Usually this is a straight difference in the current displayed units. For example, if the trace format is LogMag (dBm), the delta marker displays the difference in dB, thus showing a power ratio. But if the trace format is Real, then the delta marker shows a voltage difference, not a ratio. Exceptions for this are:

- When the trace format is Linear Mag or Log Mag (linear unit) the delta marker displays a voltage ratio, or (if the Y Axis unit is Power) a power ratio, rather than a difference.
- When either the marker or its reference has a marker function turned on, the delta marker always displays a ratio or its decibel equivalent. See Marker Function for more details on how delta markers work with marker functions. The type of ratio calculated (power or voltage) depends on the delta marker units; the reference marker value is converted as needed so it has compatible units.
- When the trace format is Wrap Phase, the delta marker readout is constrained to the wrapped phase display range, which is usually $(-180, +180]$ degrees. For example, if the absolute phase at marker 1 is 170 deg and its reference has phase of -170 deg, the delta will not show 340 deg, but -20 deg. Note that the Wrap Phase display range can be changed (see Trace/Detector, Phase/Delay Properties, Phase/Trellis Offset).

There is no current support for calculating deltas across traces (and this cannot be done at all unless the traces have the same domain and ranges).

By default, the reference marker for marker 1 is marker 2; for marker 2 is 3 and so on, but the reference marker may be changed. See the section on the "Relative To" softkey below.

The following coupling rules apply from the front panel, and also if the equivalent SCPI commands are sent.

Pressing the Delta key causes the selected marker becomes a delta marker if it is not already. Also, the selected marker's reference is affected as follows:

- If the reference marker was off, it is turned on as a fixed marker.
- The reference marker is moved to the trace of the selected marker and set to the same position as the selected marker.
- If the delta marker has a marker function turned on, the reference marker takes on the same function (with the same band limits).

Exception: Pressing Delta when the selected marker's mode is not yet Delta does not move or change a reference marker that is already turned on (Normal, Delta, or Fixed) and on the same trace as the selected marker. It merely changes the selected marker's mode to Delta and shows the current offset between it and the reference. If you press Delta again (when the selected marker is already in Delta mode) then the reference is moved and modified as described above.

When a delta marker is changed to any other control mode, if its reference marker is fixed then the reference marker is also turned off.

If you move a delta marker to a different trace, it is forced to Normal mode, and if its reference is fixed, the reference is turned off.

Common Measurement Functions 2

A delta marker is forced to Normal mode if you turn its reference off, or if you move its reference to another trace. (In the latter case the reference is not turned off even if it is fixed.)

If you change the selected marker's reference (using the Marker, Properties, Relative To) the selected marker is forced to Delta mode. This change of the selected marker to Delta mode causes its new reference's control mode and position to change as described above.

For Control Mode SCPI command information see: [“Control Mode” on page 1671](#)

Key Path	Marker
Mode	VSA, LTE, LTETDD, IDEN
Initial S/W Revision	Prior to A.02.00
Modified at S/W Revision	A.02.00

Fixed

Fixed markers are mainly used as reference markers for Delta markers. A fixed marker's X and Y Axis values may be directly or indirectly specified by you, and they remain fixed once specified, i.e. they do not follow the trace data value. These markers are represented on the display by an “X” rather than a diamond. If a marker is changed from off to fixed, the X and Y (and Z) values are chosen to put it in the center of the display. If the marker is changed from some other type to fixed, the current X and Z values of the marker remain unchanged. The Y value is taken from the current trace data value and must be changed manually thereafter.

For Control Mode SCPI command information see: [“Control Mode” on page 1671](#)

Key Path	Marker
Mode	VSA, LTE, LTETDD, IDEN
Initial S/W Revision	Prior to A.02.00
Modified at S/W Revision	A.02.00

Off

Turning a marker off makes it invisible, and also its annotation.

Turning a marker on (i.e. changing its control mode from Off to any other control mode) assigns the marker to the currently selected trace.

For Control Mode SCPI command information see: [“Control Mode” on page 1671](#)

Key Path	Marker
Mode	VSA, LTE, LTETDD, IDEN
Initial S/W Revision	Prior to A.02.00
Modified at S/W Revision	A.02.00

Coupling of Delta and Reference Markers

The following coupling rules apply from the front panel, and also if the equivalent SCPI commands are sent.

Pressing the Delta key causes the selected marker becomes a delta marker if it is not already. Also, the selected marker's reference is affected as follows:

- If the reference marker was off, it is turned on as a fixed marker.
- The reference marker is moved to the trace of the selected marker and set to the same position as the selected marker.
- If the delta marker has a marker function turned on, the reference marker takes on the same function (with the same band limits).

Exception: Pressing Delta when the selected marker's mode is not yet Delta does not move or change a reference marker that is already turned on (Normal, Delta, or Fixed) and on the same trace as the selected marker. It merely changes the selected marker's mode to Delta and shows the current offset between it and the reference. If you press Delta again (when the selected marker is already in Delta mode) then the reference is moved and modified as described above.

When a delta marker is changed to any other control mode, if its reference marker is fixed then the reference marker is also turned off.

If you move a delta marker to a different trace, it is forced to Normal mode, and if its reference is fixed, the reference is turned off.

A delta marker is forced to Normal mode if you turn its reference off, or if you move its reference to another trace. (In the latter case the reference is not turned off even if it is fixed.)

If you change the selected marker's reference (using the Marker, Properties, Relative To) the selected marker is forced to Delta mode. This change of the selected marker to Delta mode causes its new reference's control mode and position to change as described above.

Marker Position

Marker position is used to select which data point in a trace we want to read out with the marker (or where to locate a fixed marker). The marker position is primarily set in terms of the domain units, not trace points (although it can be set in terms of points via SCPI). The default active function when you press a marker hard key is the X position for the currently selected marker. The exception to this is when the selected marker is fixed. In that case there is no default active function (to prevent inadvertently changing a fixed marker's location).

Marker position is not defined when a marker's control mode is Off. When a marker is turned on in Normal or Delta mode, its X (and Z) values are set to the center of the trace data. If a marker is turned on in Fixed mode, its position is set so that it appears in the middle of the trace grid.

The Marker Position key branches to the Marker Position menu, which allows you to set any position variable relevant to the selected marker's control mode and trace format.

For Normal and Delta markers, usually only Marker X is available. Marker Z is available for trace data with 2-dimensional domain. For Fixed markers, Y may also be set. If the trace format is Vector or Constellation, Marker Y controls the real (horizontal axis) value and Marker Y Imag controls the

Common Measurement Functions 2

imaginary (vertical axis) value. The key (or the keys below it) is grayed out if the selected marker is off.

Key Path	Marker
Mode	VSA, LTE, LTETDD, IDEN
Initial S/W Revision	Prior to A.02.00
Modified at S/W Revision	A.02.00

Marker X

This sets the selected marker's X Axis value position in the current X Axis Scale unit. If the control mode is Off, the SCPI command has no effect other than to cause the marker to become selected. Note that the X value may change if the marker is moved to a trace with a different domain.

The Marker X position is absolute if the marker control mode is Normal or Fixed. If the control mode is Delta, then the X position is relative to the reference marker. The valid X positions are the actual data points in the trace; the marker cannot be located between points. If a SCPI command attempts to place the marker between two points, the X value snaps to the closest point.

Note that for Vector or Constellation format, the X axis is perpendicular to the screen (because the screen axes are used to show the real and imaginary parts of the Y value), so adjusting the X value in this case will only cause the marker to move horizontally if the real Y value changes. For Fixed markers on a trace with one of these formats, adjusting the X value will not cause horizontal motion of the marker at all. Instead, you use the Marker Y and Marker Y (imag) controls to move the marker horizontally and vertically.

Key Path	Marker, Marker Position
Mode	VSA, LTE, LTETDD, IDEN
Measurement	<meas>:=VECTor ADEMod DDEMod W11A W11B EVM IPOWer IDEMod MOTotalk
Remote Command	:CALCulate:<meas>:MARKer[1] 2 3 4 5 6 7 8 9 10 11 12:X <real> :CALCulate:<meas>:MARKer[1] 2 3 4 5 6 7 8 9 10 11 12:X?
Example	CALC:VECT:MARK:X 0.325 CALC:VECT:MARK:X?
Notes	Marker X will not go outside the bounds of the data unless it is Fixed. If you attempt to set it to a value outside the bounds it will be clipped at the closest limit, and error -222 Data Out of Range is generated. If suffix is sent, it must match the X units for the trace the marker is on. Otherwise, error -138, "Suffix not allowed" is generated. If you try to read or set the position of a Delta marker, remember that the position is in relative units.
Couplings	See Coupling at the end of the Control Mode section. See also Couple Markers section.

Preset	None until marker is turned on.
State Saved	Saved in instrument state.
Min	Depends on trace data
Max	Depends on trace data
Initial S/W Revision	Prior to A.02.00
Modified at S/W Revision	A.02.00

SCPI only X position commands

Via SCPI, the marker position may also be set or queried in trace points. In this case, the position setting or reading is absolute regardless of control mode.

NOTE The entered value in Trace Points is immediately translated into the current domain units for setting the value of the marker. The marker's value in domain units, NOT trace points, will be preserved if a change is made to the X Axis scale settings. Thus, if you use this command to place a marker on point 500, which happens at that time to correspond to 13 GHz, and then you change the Start Frequency so that point 500 is no longer 13 GHz, the marker will stay at 13 GHz, NOT at point 500.

If the trace the marker is on has a 2-dimensional domain, then the points are numbered in the following way:

Starting at the minimum X and Z position, this point is numbered 0. Each time you increment the point number, increment the X value to the next available value. When X reaches the maximum X position, then reset X to the minimum and increment the Z value. Then continue incrementing the X position in the same manner as before.

Note that for symbol tables, which have no axes, incrementing the X position in points moves the marker consecutively through all table entries.

Mode	VSA, LTE, LTETDD, IDEN
Measurement	<meas>:=VECTor ADEMod DDEMod W11A W11B EVM IPOWER IDEMod MOTotalk
Remote Command	:CALCulate:<meas>:MARKer[1] 2 3 4 5 6 7 8 9 10 11 12 [:X]:POSition <real> :CALCulate:<meas>:MARKer[1] 2 3 4 5 6 7 8 9 10 11 12 [:X]:POSition?
Example	CALC:VECT:MARK:POS 25 CALC:VECT:MARK:POS?
Notes	When a marker control mode is changed from off to any other mode, the X position is set to mid-screen.
Couplings	Same couplings as for Marker X value

Common Measurement Functions 2

Preset	None until marker is turned on.
State Saved	Saved in instrument state.
Min	Depends on trace data
Max	Depends on trace data
Initial S/W Revision	Prior to A.02.00
Modified at S/W Revision	A.02.00

Marker X Unit may be queried via SCPI

Mode	VSA, LTE, LTETDD, IDEN
Measurement	<meas>:=VECTor ADEMod DDEMod W11A W11B EVM IPOWer IDEMod MOTotalk
Remote Command	:CALCulate:<meas>:MARKer[1] 2 3 4 5 6 7 8 9 10 11 12:X: UNIT?
Example	CALC:VECT:MARK:X:UNIT?
Notes	Query Only
Initial S/W Revision	Prior to A.02.00
Modified at S/W Revision	A.02.00

Marker Y

This function only affects fixed markers. It allows you to set or read back the selected marker's Y Axis value in the current Y Axis Scale unit. Setting the Y value has no effect (other than to cause the marker to become selected) if the control mode is other than fixed. The query form generates an error if the control mode is Off. Note that the Y value may change if the Y-axis units change, either from a change in format of the trace the marker is on, or if the marker is moved to a different trace.

If the selected marker is on a trace that is displayed with Vector or Constellation format, this function controls only the real part of the Y value (i.e., the horizontal axis value). Use the Marker Y (imag) control to change the imaginary (vertical) value. Marker Y and Marker Y Imag always set or get the rectangular form of Y, regardless of whether the marker readout is polar or rectangular.

Key Path	Marker, Marker Position
Mode	VSA, LTE, LTETDD, IDEN
Measurement	<meas>:=VECTor ADEMod DDEMod W11A W11B EVM IPOWer IDEMod MOTotalk
Remote Command	:CALCulate:<meas>:MARKer[1] 2 3 4 5 6 7 8 9 10 11 12:Y [:REAL] <real> :CALCulate:<meas>:MARKer[1] 2 3 4 5 6 7 8 9 10 11 12:Y [:REAL]?

Example	CALC:VECT:MARK2:Y 0.325 CALC:VECT:MARK2:Y?
Notes	You cannot set Y unless the marker type is fixed. If the marker becomes fixed after a marker function is turned on, it is set to whatever the Y value was when the marker became fixed. If suffix is sent, it must match the Y units for the trace the marker is on. Otherwise, error -138, "Suffix not allowed" is generated.
Couplings	Changes if marker is relative to a Delta marker that is turned on or re-zeroed (see Coupling of Delta and Reference Markers).
Preset	None until marker is turned on.
State Saved	Saved in instrument state.
Min	-9.9E+37
Max	9.9E+37
Initial S/W Revision	Prior to A.02.00
Modified at S/W Revision	A.02.00

Marker Y Unit may be queried via SCPI.

Mode	VSA, LTE, LTETDD, IDEN
Measurement	<meas>:=VECTor ADEMod DDEMod W11A W11B EVM IPOWer IDEMod MOTotalk
Remote Command	:CALCulate:<meas>:MARKer[1] 2 3 4 5 6 7 8 9 10 11 12:Y:UNIT?
Example	CALC:VECT:MARK:Y:UNIT?
Notes	Query Only
Initial S/W Revision	Prior to A.02.00
Modified at S/W Revision	A.02.00

Marker Y Imag (Imaginary)

This only affects fixed markers and is only available when the trace format is Vector or Constellation. It allows you to set or read back the selected marker's quadrature (imaginary) Y value in the current Y Axis Scale unit. It has no effect (other than to cause the marker to become selected) if the control mode is other than fixed, or if the current trace format is not complex. The query form generates an error if it is used for a marker that is not on a complex trace. Marker Y Imag is not affected by whether the marker readout is polar or rectangular.

Key Path	Marker, Marker Position
Mode	VSA, LTE, LTETDD, IDEN

Common Measurement Functions 2

Measurement	<meas>:=VECTor ADEMod DDEMod W11A W11B EVM IPOWer IDEMod MOTotalk
Remote Command	:CALCulate:<meas>:MARKer[1] 2 3 4 5 6 7 8 9 10 11 12:Y:IMAGinary <real> :CALCulate:<meas>:MARKer[1] 2 3 4 5 6 7 8 9 10 11 12:Y:IMAGinary?
Example	CALC:DDEM:MARK1:Y:IMAG 0.435 CALC:DDEM:MARK1:Y:IMAG?
Notes	Grayed out unless the marker is fixed and on a vector display. If suffix is sent, it must match the Y units for the trace the marker is on. Otherwise, an Invalid Suffix error is generated. Otherwise, error -138, "Suffix not allowed" is generated. If query is sent while the marker is on a trace whose format is not vector or constellation, NaN (9.91E+37) is returned.
Preset	None until marker is turned on.
State Saved	Saved in instrument state.
Min	Depends on trace format
Max	Depends on trace format
Initial S/W Revision	Prior to A.02.00
Modified at S/W Revision	A.02.00

Marker Z

For markers on traces with a 2-dimensional domain, this sets the selected markers Z Axis value in the current Z Axis Scale unit. In each case the marker that is addressed becomes the selected marker. It has no effect (other than to cause the marker to become selected) if the control mode is **Off**, or if the trace has no Z domain. Note that the Z value may change or become irrelevant if the marker is moved to a trace with a different Z domain, or no Z domain.

Note that this Z value is affected if the SCPI command to set marker point position is used.

Key Path	Marker, Marker Position
Mode	VSA, LTE, LTETDD, IDEN
Measurement	<meas>:=VECTor ADEMod DDEMod W11A W11B EVM IPOWer IDEMod MOTotalk
Remote Command	:CALCulate:<meas>:MARKer[1] 2 3 4 5 6 7 8 9 10 11 12:Z<real> :CALCulate:<meas>:MARKer[1] 2 3 4 5 6 7 8 9 10 11 12:Z?
Example	CALC:OFDM:MARK:Z 12 CALC:OFDM:MARK:Z?

Notes	Marker Z will not go outside the bounds of the data unless it is Fixed. If you attempt to set it to a value outside the bounds it will be clipped at the closest limit, and error -222 Data Out of Range is generated. If suffix is sent, it must match the Z units for the trace the marker is on. Otherwise, error -138, "Suffix not allowed" is generated.
Couplings	See Coupling at the end of the Control Mode section. See also Couple Markers section.
Preset	None until marker is turned on.
State Saved	Saved in instrument state.
Min	Depends on trace data
Max	Depends on trace data
Initial S/W Revision	Prior to A.02.00
Modified at S/W Revision	A.02.00

Marker Z Unit may be queried via SCPI.

Mode	VSA, LTE, LTETDD, IDEN
Measurement	<meas>:=VECTor ADEMod DDEMod W11A W11B EVM IPOWER IDEMod MOTotalk
Remote Command	:CALCulate:<meas>:MARKer[1] 2 3 4 5 6 7 8 9 10 11 12:Z:UNIT?
Example	CALC:OFDM:MARK:Z:UNIT?
Notes	Query Only
Initial S/W Revision	Prior to A.02.00
Modified at S/W Revision	A.02.00

Marker Properties

The Marker Properties key accesses a menu of common marker properties.

Key Path	Marker
Mode	VSA, LTE, LTETDD, IDEN
Initial S/W Revision	Prior to A.02.00

Relative To

This key allows you to specify which marker is used as a reference for the selected marker when the selected marker's control mode is set to Delta. By default, the reference marker is numerically one higher than the selected marker, that is, marker 1 is relative to marker 2, marker 2 to marker 3, and so on. Marker 12 by default is relative to marker 1. This key allows you to change the reference marker from

Common Measurement Functions 2

the default. Note that a marker cannot be made relative to itself.

Key Path	Marker, Properties
Mode	VSA, LTE, LTETDD, IDEN
Measurement	<meas>:=VECTor ADEMod DDEMod W11A W11B EVM IPOWer IDEMod MOTotalk
Remote Command	:CALCulate:<meas>:MARKer[1] 2 3 4 5 6 7 8 9 10 11 12: REFerence <integer> :CALCulate:<meas>:MARKer[1] 2 3 4 5 6 7 8 9 10 11 12: REFerence?
Example	CALC:VECT:MARK2:REF 4 CALC:VECT:MARK2:REF?
Notes	The reference marker cannot be the same value as the selected marker, i.e., a marker cannot be relative to itself. The currently selected marker will not be an available choice in the relative to selection (i.e. the selected marker will appear grayed out). When queried a single value will be returned (the specified marker numbers relative marker).
Couplings	See Coupling of Delta and Reference Markers above. The old reference remains as it was.
Preset	2 3 4 5 6 7 8 9 10 11 12 1
State Saved	Saved in instrument state.
Range	1 2 3 4 5 6 7 8 9 10 11 12
Initial S/W Revision	Prior to A.02.00
Modified at S/W Revision	A.02.00

Complex Format

This determines the format for the readout when a marker is placed on a complex display (vector or constellation). The choices are to read out in rectangular or polar coordinates. The readout format applies to the marker display and marker table only; there is no SCPI for reading out the marker value in polar form.

Key Path	Marker, Properties
Mode	VSA, LTE, LTETDD, IDEN
Measurement	<meas>:=VECTor ADEMod DDEMod W11A W11B EVM IPOWer IDEMod MOTotalk

Remote Command	:CALCulate:<meas>:MARKer[1] 2 3 4 5 6 7 8 9 10 11 12: CFORmat RECTangular POLar :CALCulate:<meas>:MARKer[1] 2 3 4 5 6 7 8 9 10 11 12: CFORmat?
Example	CALC:VECT:MARK1:CFOR RECT CALC:VECT:MARK1:CFOR?
Preset	RECT
State Saved	Saved in instrument state.
Range	Rect Polar
Initial S/W Revision	Prior to A.02.00
Modified at S/W Revision	A.02.00

Marker Trace

This key allows you to determine the trace to which a marker is assigned. By default, when a marker is turned on it is assigned to the currently selected trace. You may change that assignment using this control.

Key Path	Marker, Properties
Mode	VSA, LTE, LTETDD, IDEN
Measurement	<meas>:=VECTor ADEMod DDEMod W11A W11B EVM IPOWer IDEMod MOTotalk
Remote Command	:CALCulate:<meas>:MARKer[1] 2 3 4 5 6 7 8 9 10 11 12: TRACe <integer> :CALCulate:<meas>:MARKer[1] 2 3 4 5 6 7 8 9 10 11 12: TRACe?
Example	CALC:VECT:MARK3:TRAC 2 CALC:VECT:MARK3:TRAC?
Couplings	See Couplings of Delta and Reference Markers above..
Preset	Marker is assigned to currently selected trace when turned on.
State Saved	Saved in instrument state.
Range	Trace 1 Trace2 Trace 3 Trace 4
Min	1
Max	4
Initial S/W Revision	Prior to A.02.00
Modified at S/W Revision	A.02.00

Common Measurement Functions 2

Marker Count

This key enables the frequency counter algorithm on the selected marker. This algorithm can more precisely determine the frequency of a peak. The marker must be on a frequency domain trace, with data coming from hardware. Place the marker on a peak and enable the frequency counter. The marker readout then shows the calculated frequency rather than the marker X position. Only one marker can be counted at any time. Turning on marker count for any marker turns it off for all other markers.

Key Path	Marker, Properties
Mode	VSA, IDEN
Measurement	<meas>:=VECTor ADEMod DDEMod W11A W11B EVM IPOWER IDEMod MOTotalk
Remote Command	:CALCulate:<meas>:MARKer[1] 2 3 4 5 6 7 8 9 10 11 12: FCOunt[:STATe] OFF ON 0 1 :CALCulate:<meas>:MARKer[1] 2 3 4 5 6 7 8 9 10 11 12: FCOunt[:STATe]?
Example	CALC:VECT:MARK:FCO ON CALC:VECT:MARK:FCO?
Notes	Marker must be on a frequency-domain trace and data must be live, not recorded or simulated.
Preset	OFF
State Saved	Saved in instrument state.
Range	Off On
Initial S/W Revision	Prior to A.02.00
Modified at S/W Revision	A.02.00

The frequency counter result must be read back with the following SCPI command. The Marker X query command will only get the marker's data point position, which will not be as accurate as the frequency counter result.

Key Path	SCPI only
Mode	VSA, IDEN
Measurement	<meas>:=VECTor ADEMod DDEMod W11A W11B EVM IPOWER IDEMod MOTotalk
Remote Command	:CALCulate:<meas>:MARKer[1] 2 3 4 5 6 7 8 9 10 11 12: FCOunt:X?
Example	CALC:VECT:MARK:FCO:X?
Notes	Query only. If the marker counter result is unavailable, NaN is returned.
Initial S/W Revision	Prior to A.02.00

Modified at S/W Revision	A.02.00
--------------------------	---------

Marker Table

When the Marker Table is turned on, the display is split into a measurement window and a marker data display window. For each marker which is on, information is displayed in the data display window, which includes the marker number, control mode, trace number, X axis scale, X axis value, and the Y-axis result. Additional information is shown for markers which have marker functions turned on.

Key Path	Marker
Mode	VSA, LTE, LTETDD, IDEN
Measurement	<meas>:=VECTor ADEMod DDEMod W11A W11B EVM IPOWER IDEMod MOTotalk
Remote Command	:CALCulate:<meas>:MARKer:TABLE[:STATE] OFF ON 0 1 :CALCulate:<meas>:MARKer:TABLE[:STATE]?
Example	CALC:VECT:MARK:TABL ON CALC:VECT:MARK:TABL?
Preset	OFF
State Saved	No
Range	Off On
Initial S/W Revision	Prior to A.02.00
Modified at S/W Revision	A.02.00

Couple Markers

Marker Coupling affects all currently displayed markers. In general when coupling is turned on then all Normal or Delta markers with the same (or equivalent) domain as the selected marker move in the same manner as the selected marker. Coupling is relative between markers on the same trace (so that their relative positions in the domain are maintained). Coupling can be absolute between markers on different traces that have equivalent domains. That is, they are forced have the same position in the domain, if possible. (As an example of equivalent domains, demodulated symbol positions can be derived from time by using the current symbol rate). When you move the selected marker, then others on related traces track it. This is to allow you to correlate different measurement results. For example, to you can place a marker at a particular symbol time on an error vector magnitude display, and have tracking markers on the symbol table and pre-demod time trace, showing you the symbol value and the actual time-varying signal value at the same point in time.

Absolute coupling is performed only for the lowest numbered Normal or Delta marker on each trace. All other markers on a trace couple relatively. When you turn on marker coupling, the subset of markers that have the same domain as the selected marker track it and all other markers remain at their current location. The absolutely coupled markers within this subset will be moved at this time to match the domain setting of the selected marker, with the relatively coupled markers following accordingly to maintain offsets within their respective traces. Those markers with different domains remain at their current location. When you select a marker with a different domain than the previously selected marker,

Common Measurement Functions 2

then the subset of markers with that domain go through the same procedure.

Any marker that coupling would move outside its range of X values, will remain at the closest limiting value until the selected marker moves in such a way as to bring the coupled X value back into range. If the coupled markers are on data that do not have the same domain resolution, then they are positioned as close to each other as possible.

If markers change mode or trace, or trace data is changed below them, the coupling rules are immediately applied to the new set.

Key Path	Marker
Mode	VSA, LTE, LTETDD, IDEN
Measurement	<meas>:=VECTor ADEMod DDEMod W11A W11B EVM IPOWer IDEMod MOTotalk
Remote Command	:CALCulate:<meas>:MARKer:COUple[:STATe] OFF ON 0 1 :CALCulate:<meas>:MARKer:COUple[:STATe]?
Example	CALC:VECT:MARK:COUP ON CALC:VECT:MARK:COUP?
Preset	OFF
State Saved	Saved in instrument state.
Range	Off On
Initial S/W Revision	Prior to A.02.00
Modified at S/W Revision	A.02.00

All Markers Off

This function turns all markers off and sets the selected marker to 1.

Key Path	Marker
Mode	VSA, LTE, LTETDD, IDEN
Measurement	<meas>:=VECTor ADEMod DDEMod W11A W11B EVM IPOWer IDEMod MOTotalk
Remote Command	:CALCulate:<meas>:MARKer:AOFF
Example	CALC:VECT:MARK:AOFF:
Initial S/W Revision	Prior to A.02.00
Modified at S/W Revision	A.02.00

Marker -> (Marker To)

The Marker -> hardkey provides access to some convenient functions for copying the marker position to a number of frequency and Y-axis scaling parameters. These functions are available from the front panel

only. No SCPI is provided, because you can already read the marker position via SCPI and then set any frequency or scaling parameter accordingly, with full accuracy.

Pressing the Marker -> hardkey always makes the selected marker's X position the active function.

If the selected marker is off, pressing the Marker -> hardkey turns on the selected marker in normal mode on the currently selected trace.

Key Path	Front Panel
Mode	VSA, LTE, LTETDD, IDEN
Initial S/W Revision	Prior to A.02.00
Modified at S/W Revision	A.02.00

Mkr -> CF (Center Frequency)

This function sets the center frequency equal to the selected marker's absolute frequency. The marker must be on a frequency-domain trace. The absolute marker frequency is used regardless of whether its control mode is Normal, Delta, or Fixed.

If the currently selected marker is not on when this key is pressed, it will be turned on at the center of the screen as a normal type marker.

Key Path	Marker To
Mode	VSA, LTE, LTETDD, IDEN
Initial S/W Revision	Prior to A.02.00
Modified at S/W Revision	A.02.00

Mkr -> CF Step

This function sets the center frequency step size equal to the selected marker's frequency. The marker must be on a frequency-domain trace. The absolute marker frequency is used regardless of whether its control mode is Normal, Delta, or Fixed.

If the currently selected marker is not on when this key is pressed, it will be turned on at the center of the screen as a normal type marker.

Key Path	Marker To
Mode	VSA, LTE, LTETDD, IDEN
Initial S/W Revision	Prior to A.02.00
Modified at S/W Revision	A.02.00

Mkr -> Start

This function sets the start frequency equal to the selected marker's frequency. The marker must be on a frequency-domain trace. The absolute marker frequency is used regardless of whether its control mode is Normal, Delta, or Fixed.

Common Measurement Functions 2

If the currently selected marker is not on when this key is pressed, it will be turned on at the center of the screen as a normal type marker.

Key Path	Marker To
Mode	VSA, LTE, LTETDD, IDEN
Initial S/W Revision	Prior to A.02.00
Modified at S/W Revision	A.02.00

Mkr -> Stop

This function sets the stop frequency equal to the selected marker's frequency. The marker must be on a frequency-domain trace. The absolute marker frequency is used regardless of whether its control mode is Normal, Delta, or Fixed.

If the currently selected marker is not on when this key is pressed, it will be turned on at the center of the screen as a normal type marker.

Key Path	Marker To
Mode	VSA, LTE, LTETDD, IDEN
Initial S/W Revision	Prior to A.02.00
Modified at S/W Revision	A.02.00

Mkr Delta -> Span

This function sets the start and stop frequencies to equal to the selected marker's frequency and that of its reference. That is, the measurement span is "zoomed in" so that the selected marker and its associated reference appear on the extreme left and right of the display. The marker must be on a frequency-domain trace and its control mode must be Delta.

Key Path	Marker To
Mode	VSA, LTE, LTETDD, IDEN
Initial S/W Revision	Prior to A.02.00
Modified at S/W Revision	A.02.00

Mkr -> Ref Lvl

This function sets the Y axis reference value equal to the selected marker's Y value. For example, if the reference position is at the top of the screen, the whole trace is moved up so that the marker appears at the top of the screen. Note that this is a display scaling function only. The input range remains the same.

Key Path	Marker To
Mode	VSA, LTE, LTETDD, IDEN
Initial S/W Revision	Prior to A.02.00

Modified at S/W Revision	A.02.00
--------------------------	---------

Counter -> CF (Center Frequency)

This function copies the frequency of the marker counter to the center frequency. The marker counter function must be on.

Key Path	Marker To
Mode	VSA, IDEN
Initial S/W Revision	Prior to A.02.00
Modified at S/W Revision	A.02.00

Mkr Delta -> CF (Center Frequency)

This function sets the center frequency equal to the difference in frequency between the selected Delta marker and its reference. The marker must be on a frequency-domain trace and the selected marker's control mode must be Delta.

Key Path	Marker To
Mode	VSA, LTE, LTETDD, IDEN
Initial S/W Revision	Prior to A.02.00
Modified at S/W Revision	A.02.00

Marker Function

This key accesses a menu of selectable marker functions for VSA based measurements.

Marker Functions perform post-processing operations on marker data. Band Functions are Marker Functions that allow you to define a band of frequencies around the marker. The band defines the region of data used for the numerical calculations. These marker functions also allow you to perform mathematical calculations on trace and marker data and report the results of these calculations in place of the normal marker result.

Unlike regular markers, marker function markers are not placed directly on the trace. They are placed at a location which is relative to the result of the function calculation.

The Marker Function menu gives you access to power calculations in bands of frequencies or time intervals centered on a marker. It also allows you to make calculations like carrier to noise by combining delta markers with marker functions. Marker functions are generally available for time and frequency domain traces, and not for others. If the marker function calculation is undefined for particular trace data, then "---" is shown in place of a number in the result display and marker table, and `CALC:<meas>:MARK[n]:Y?` will return 9.91E+37 (NaN).

Pressing Marker Function always makes the selected marker's X position the active function.

If the selected marker is off, pressing the Marker Function hardkey turns on the selected marker in

Common Measurement Functions 2

normal mode on the currently selected trace.

Key Path	Marker Function
Mode	VSA, LTE, LTETDD, IDEN
Measurement	<meas>:=VECTor ADEMod DDEMod W11A W11B EVM IPOWer IDEMod MOTotalk
Remote Command	:CALCulate:<meas>:MARKer[1] 2 3 4 5 6 7 8 9 10 11 12: FUNction BPOWer BDENsity =OFF :CALCulate:<meas>:MARKer[1] 2 3 4 5 6 7 8 9 10 11 12: FUNction?
Example	CALC:VECT:MARK1:FUNC BPOW CALC:VECT:MARK1:FUNC?
Notes	:CALC:<meas>:MARK1:FUNC? returns the current function type for marker 1. To return the result, use :CALC:<meas>:MARK1:Y?
Preset	=OFF
State Saved	Saved in instrument state.
Range	Band Power Band Density Off
Initial S/W Revision	Prior to A.02.00
Modified at S/W Revision	A.02.00

Band/Interval Power

Turns on the Band/Interval Power function for the selected marker. This function calculates the power within the band centered on the marker. The function works generally with frequency spectra, PSD and time traces. On traces where band power is undefined, the result display shows "---" and CALC:<meas>:MARK[n]:Y? will return 9.91E+37 (NaN), although the band interval can still be defined.

Frequency-domain data

If the marker is on a frequency-domain trace, the result is total power within the band. This is true whether the underlying trace data is a power spectrum or power spectral density.

Time-domain data

If the marker is on a time-domain trace, the result is average power within the time interval, that is, the power at each time sample in the time interval is calculated, the powers are summed and the total divided by the number of samples.

Key Path	Marker Function
Mode	VSA, LTE, LTETDD, IDEN
Initial S/W Revision	Prior to A.02.00

Modified at S/W Revision	A.02.00
--------------------------	---------

Band Power Calculation

A band/interval power calculation result may be shown in dBm, dBVrms, Watts, Volts RMS Squared or Volts RMS. The table below shows the choice of display units if Band Power Calculation is set to Mean, depending on the current format and Y units of the trace the marker is on.

Trace data type	Trace Format	Y Unit	Result format
Spectrum, PSD, Time record	LogMag (dB)	Auto, Power	dBm
		Peak, RMS	dBVrms
		mRMS	dBmVrms
	Linear Mag, Real, Imag, Log Mag (lin)	Auto, Peak, RMS, mRMS	Vrms^2
		Power	W
		Any	Vrms^2
		Any	blanked
Dimensionless (e.g., Frequency response, Impulse response, various Demodulation error types)	LogMag (dB)	Any	dBrms
	Linear Mag, Real, Imag, Wrap Phase, Unwrap Phase, Delay, Log Mag (lin)	Any	rms^2
General dimensions(e.g., Hz, %)	LogMag (dB)	Any	dB<unit>rms
	Linear Mag, Real, Imag, Wrap Phase, Unwrap Phase, Delay, Log Mag (lin)	Any	<unit>rms^2

If the Band Power Calculation is set to RMS, then the readout unit does not depend on trace format or Y unit. For Spectrums, PS and Time record traces the displayed unit is "Vrms" For general units, the unit abbreviation is shown followed by "rms".

The Band Power Calculation only controls the readout format for Normal and Fixed markers. For Delta markers, see the discussion below.

Key Path	Marker Function, Band/Interval Power
Mode	VSA, LTE, LTETDD, IDEN
Measurement	<meas>:=VECTor ADEMod DDEMod W11A W11B EVM IPOWER IDEMod MOTalk

Common Measurement Functions 2

Remote Command	:CALCulate:<meas>:MARKer[1] 2 3 4 5 6 7 8 9 10 11 12: FUNction:BPOWer:CTYPe MEAN RMS :CALCulate:<meas>:MARKer[1] 2 3 4 5 6 7 8 9 10 11 12: FUNction:BPOWer:CTYPe?
Example	CALC:VECT:MARK1:FUNC:BPOW:CTYP MEAN CALC:VECT:MARK1:FUNC:BPOW:CTYP?
Preset	MEAN
State Saved	Saved in instrument state.
Range	Mean RMS
Initial S/W Revision	Prior to A.02.00
Modified at S/W Revision	A.02.00

Band/Interval Density

This function calculates the average power density within the band centered on the marker. The function works generally with frequency spectra, PSD and time traces. On traces where band power cannot reasonably be defined, the result display shows "---" and CALC:<meas>:MARK[n]:Y? returns NaN (9.91E+37), although the band interval can still be defined.

Frequency-domain data

If the marker is on a frequency-domain trace, the result is the band power (as computed above) divided by the bandwidth over which it is measured. This is true whether the underlying trace data is a power spectrum or power spectral density.

Time-domain data

If the marker is on a time-domain trace, the result is average power within the time interval (as computed above) divided by the equivalent noise bandwidth of the span.

Key Path	Marker Function
Mode	VSA, LTE, LTETDD, IDEN
Initial S/W Revision	Prior to A.02.00
Modified at S/W Revision	A.02.00

Band Density Calculation

Turns on the Band/Interval Density function for the selected marker. If the selected marker is off, it is turned on in Normal marker mode and located at the center of the screen.

When Band/Interval Density is selected while in the Marker Function Off state, the Band Span or Interval Span is initialized to 5% of the screen width.

If the detector mode for the detector on the marker's trace is set to Auto, the average detector is selected. If the Average type is set to Auto, Power Averaging is selected. Other choices for the detector or Average

type will usually cause measurement inaccuracy.

A band/interval density calculation result may be shown in dBm/Hz, Volts RMS Squared or Volts RMS. The table below shows the choice of display units if Band Density Calculation is set to Mean, depending on the current format of the trace the marker is on.

Trace data type	Trace Format	Result format
Spectrum, PSD, Time record	LogMag (dB)	dBm/Hz
	Linear Mag, Real, Imag, Wrap Phase, Unwrap Phase, Delay, Log Mag (lin)	Vrms^2/Hz
Dimensionless (e.g., Frequency response, Impulse response, various Demodulation error types)	LogMag (dB)	dBrms/Hz
	Linear Mag, Real, Imag, Wrap Phase, Unwrap Phase, Delay, Log Mag (lin)	rms^2/Hz
General dimensions(e.g., Hz, %)	LogMag (dB)	dB<unit>rms/Hz
	Linear Mag, Real, Imag, Wrap Phase, Unwrap Phase, Delay, Log Mag (lin)	<unit>rms^2/Hz

If the Band Density Calculation is set to RMS, then the readout unit does not depend on trace format. For Spectrum, PSD and Time record traces the displayed unit is "Vrms/rtHz" For general units, the unit abbreviation is shown followed by "rms/rtHz".

The Band Density Calculation only controls the readout format for Normal and Fixed markers. For Delta markers, see the discussion below.

Key Path	Marker Function, Band/Interval Power
Mode	VSA, LTE, LTETDD, IDEN
Measurement	<meas>:=VECTor ADEMod DDEMod W11A W11B EVM IPOWER IDEMod MOTotalk
Remote Command	:CALCulate:<meas>:MARKer[1] 2 3 4 5 6 7 8 9 10 11 12: FUNction:BDENsity:CTYPe MEAN RMS :CALCulate:<meas>:MARKer[1] 2 3 4 5 6 7 8 9 10 11 12: FUNction:BDENsity:CTYPe?
Example	CALC:VECT:MARK1:FUNC:BDEN:CTYP RMS CALC:VECT:MARK1:FUNC:BDEN:CTYP?
Preset	MEAN
State Saved	Saved in instrument state.
Range	Mean RMS
Initial S/W Revision	Prior to A.02.00

Common Measurement Functions 2

Modified at S/W Revision	A.02.00
--------------------------	---------

Band Adjust

These keys allow you to define the bandwidth around the marker. The band is always centered on the marker position. Entering the menu always sets Band/Interval Span as the active function

Key Path	Marker Function
Mode	VSA, LTE, LTETDD, IDEN
Initial S/W Revision	Prior to A.02.00
Modified at S/W Revision	A.02.00

Band/Interval Center

This function defines the center of the band. That is, it allows you to adjust the marker position in absolute units (regardless of whether the marker mode is Normal or Delta).

Key Path	Marker Function, Band Adjust
Mode	VSA, LTE, LTETDD, IDEN
Measurement	<meas>:=VECTor ADEMod DDEMod W11A W11B EVM IPOWer IDEMod MOTotalk
Remote Command	:CALCulate:<meas>:MARKer[1] 2 3 4 5 6 7 8 9 10 11 12: FUNction:BAND:CENter <real> :CALCulate:<meas>:MARKer[1] 2 3 4 5 6 7 8 9 10 11 12: FUNction:BAND:CENter?
Example	CALC:VECT:MARK2:FUNC:BAND:CENT 1.23E+09 CALC:VECT:MARK2:FUNC:BAND:CENT?
Preset	Center of screen
State Saved	Saved in instrument state.
Min	-9.9E+37
Max	9.9E+37
Initial S/W Revision	Prior to A.02.00
Modified at S/W Revision	A.02.00

Band/Interval Span

Sets the width of the span for the selected marker. This function defines the span of frequencies or time. The marker position does not change when you adjust the span.

Key Path	Marker Function, Band Adjust
Mode	VSA, LTE, LTETDD, IDEN

Measurement	<meas>:=VECTor ADEMod DDEMod W11A W11B EVM IPOWer IDEMod MOTotalk
Remote Command	:CALCulate:<meas>:MARKer[1] 2 3 4 5 6 7 8 9 10 11 12:FUNCTION:BAND:SPAN <real> :CALCulate:<meas>:MARKer[1] 2 3 4 5 6 7 8 9 10 11 12:FUNCTION:BAND:SPAN?
Example	CALC:VECT:MARK2:FUNC:BAND:SPAN 1.23E+06 CALC:VECT:MARK2:FUNC:BAND:SPAN?
Preset	When marker turned on, 1/20th of current span or displayed time length
State Saved	Saved in instrument state.
Min	-9.9E+37
Max	9.9E+37
Initial S/W Revision	Prior to A.02.00
Modified at S/W Revision	A.02.00

Band/Interval Left

This function adjusts the left side of the band. In order to remain centered in the band, the marker position must also change as you change the left edge. The right edge is unaffected.

Key Path	Marker Function, Band Adjust
Mode	VSA, LTE, LTETDD, IDEN
Measurement	<meas>:=VECTor ADEMod DDEMod W11A W11B EVM IPOWer IDEMod MOTotalk
Remote Command	:CALCulate:<meas>:MARKer[1] 2 3 4 5 6 7 8 9 10 11 12:FUNCTION:BAND:LEFT <real> :CALCulate:<meas>:MARKer[1] 2 3 4 5 6 7 8 9 10 11 12:FUNCTION:BAND:LEFT?
Example	CALC:VECT:MARK2:FUNC:BAND:LEFT 1.23E+06 CALC:VECT:MARK2:FUNC:BAND:LEFT?
Couplings	Changes marker X to keep the marker centered in the band
Preset	When marker turned on, 1/40th of current span or displayed time length left of the marker position
State Saved	Saved in instrument state.
Min	-9.9E+37
Max	9.9E+37
Initial S/W Revision	Prior to A.02.00

Common Measurement Functions 2

Modified at S/W Revision	A.02.00
--------------------------	---------

Band/Interval Right

This function adjusts the right side of the band. In order to remain centered in the band, the marker position must also change as you change the right edge. The left edge is unaffected.

Key Path	Marker Function, Band Adjust
Mode	VSA, LTE, LTETDD, IDEN
Measurement	<meas>:=VECTor ADEMod DDEMod W11A W11B EVM IPOWer IDEMod MOTotalk
Remote Command	:CALCulate:<meas>:MARKer[1] 2 3 4 5 6 7 8 9 10 11 12: FUNction:BAND:RIGHT <real> :CALCulate:<meas>:MARKer[1] 2 3 4 5 6 7 8 9 10 11 12: FUNction:BAND:RIGHT?
Example	CALC:VECT:MARK2:FUNC:BAND:RIGHT 1.23E+06 CALC:VECT:MARK2:FUNC:BAND:RIGHT?
Couplings	Changes marker X to keep the marker centered in the band
Preset	When marker turned on, 1/40th of current span or displayed time length right of the marker position
State Saved	Saved in instrument state.
Min	-9.9E+37
Max	9.9E+37
Initial S/W Revision	Prior to A.02.00
Modified at S/W Revision	A.02.00

Band Power and Delta Markers

When either a Delta marker or its reference has a band power function turned on, the Delta marker readout always shows a ratio calculation. This allows you to perform common calculations like carrier to noise ratio or adjacent channel power ratio. The form of the ratio depends on the main marker function calculation type (Mean or RMS). If the main marker function calculation type is Mean, then when you change the marker to Delta the result will be a power ratio. If the main marker function calculation type is RMS, then the Delta marker result will be a voltage ratio. (If the main marker band power function is off, then the form of the ratio depends on the reference marker calculation type: If it is Mean you get a power ratio, and if it is RMS you get a voltage ratio.)

For example, if the main marker function is Band/Interval Power with a calculation type of Mean and the reference marker function is Band/Interval Power with a calculation type of RMS, then the Delta marker will show the ratio of the main marker "Band/Interval Power Mean" value to the reference marker "Band/Interval Power Mean" (not RMS) value.

A dimensionless ratio (for example Volt/Volt or Watt/Watt) is shown with units of "x". The marker function calculation type will tell you whether the ratio is voltage or power (see above). A dimensionless

power ratio is shown with units of dB if the trace format is Log Mag (dB)

If the reference marker function is Band/Interval Density and the main marker is either Band/Interval Power or its function is turned off, then the ratio is not dimensionless, but has units of Hz (or dB-Hz) for power calculations, or rtHz for voltage calculations. When the main marker function is Band/Interval Density and the reference is either Band/interval Power or its function is off, the units are /Hz (or dB/Hz) for power calculations, or /rtHz for voltage calculations.

Key Path	Marker Function
Mode	VSA, LTE, LTETDD, IDEN
Initial S/W Revision	Prior to A.02.00
Modified at S/W Revision	A.02.00

Meas Setup

This key accesses a menu of keys that select measurement functions for VSA based Measurements.

Key Path	Front Panel
Mode	VSA, LTE, LTETDD, IDEN
Initial S/W Revision	Prior to A.02.00
Modified at S/W Revision	A.02.00

Avg Number

This key allows you to turn averaging on or off, and set the number of scans (time records) whose measurement results will be averaged. Averaging can be done over spectrum results (RMS) or over time records (Time). A third kind of pseudo averaging displays the maximum value seen at each spectral line over the specified number of scans. See Average Type for a more detailed description of how measurement results are averaged.) For RMS or Time averaging, the process is similar. Each time an averaged result is displayed, it is the sum of the individual results taken since measurement restart, divided by the number of scans. (For Max averaging, there is no actual summation or division.) The Measurement Bar shows the number of scans and the Avg number setting; for example, if 4 scans have been taken and the Avg Number is 10, the Meas Bar shows "4/10". The measurement continues to take new scans until the number of scans is equal to the Avg Number setting, at which time the measurement stops if Sweep control is in Single Mode. Otherwise, the measurement continues, and the Average Mode setting determines how successive scans are added to the averaged result. See the Average Mode topic for details.

Key Path	Meas Setup, More
Mode	VSA, LTE, LTETDD, IDEN
Measurement	<meas>:=VECTor ADEMod DDEMod W11A W11B EVM IPOWer IDEMod MOTotalk

Common Measurement Functions 2

Remote Command	<pre>[:SENSe] : <meas> : AVERage : COUNT <integer> [:SENSe] : <meas> : AVERage : COUNT? [:SENSe] : <meas> : AVERage [:STATe] OFF ON 0 1 [:SENSe] : <meas> : AVERage [:STATe] ?</pre>
Example	<pre>VECT: AVER: COUN 20 VECT: AVER: COUN? VECT: AVER ON VECT: AVER?</pre>
Notes	If an averaged measurement is idle because the scan count is equal to the Avg Number, and the Avg Number is increased, the measurement will resume until the new number of averages is satisfied.
Preset	<pre>10 OFF IPOW: ON</pre>
State Saved	Saved in instrument state.
Min	1
Max	2147483647
Initial S/W Revision	Prior to A.02.00
Modified at S/W Revision	A.02.00

Average Mode

The Average Mode determines what happens when the Sweep Mode is Continuous and the number of scans processed exceeds the Average Number (see above). If the Sweep Control is in Single mode, this setting has no effect.

When averaging is on and the number of scans is less than or equal to the Avg Number setting, a linear average is calculated as explained in the Avg Number topic. After the scan count exceeds the Avg Number setting, the measurement continues to take new scans. The Measurement Bar average indicator shows ">N/N" where N is the Avg Number.

If Average Mode is Exp then new results are averaged in exponentially. In other words, each succeeding average will be the weighted sum of the previous average, weighted by $(N-1)/N$, and the new measurement, weighted by $1/N$, where N is the Average Number setting. (For Max averaging, no weighting occurs; the result continues to be the max value seen at each spectral line for every previous scan since measurement restart.)

If Average Mode is Repeat, then the average buffer will be cleared after the average counter reaches the Average Number setting, and the average counter will be reset to 0. Then a new set of averages is taken. The measurement bar therefore continues to show "k/N" in the average indicator, where k is the number of scans since the last time the average buffer was cleared and N is the Avg Number. The averaged result is the sum of the last k results divided by k. (For Max averaging, no sum or division takes place, but the

buffer is cleared as stated above. The averaged result is the max value seen over the last k scans.)

Key Path	Meas Setup
Mode	VSA, LTE, LTETDD, IDEN
Measurement	<meas>:=VECTor ADEMod DDEMod W11A W11B EVM IPOWER IDEMod MOTotalk
Remote Command	[:SENSe] : <meas> : AVERage : TCONtrol EXPonential REPeat [:SENSe] : <meas> : AVERage : TCONtrol ?
Example	VECT:AVER:TCON EXP VECT:AVER:TCON?
Preset	EXP
State Saved	Saved in instrument state.
Range	Exp Repeat
Initial S/W Revision	Prior to A.02.00
Modified at S/W Revision	A.02.00

Average Setup

This key accesses a menu allowing you to set Averaging parameters for all VSA based measurements.

Key Path	Meas Setup
Mode	VSA, LTE, LTETDD, IDEN
Initial S/W Revision	Prior to A.02.00
Modified at S/W Revision	A.02.00

Average Type

The Average Type key allows you to select the type of averaging. The table below shows what measurement results are averaged for each average type. This applies in the Vector Measurement.

Average Type	Measurement result averaged
RMS	Spectrum, PSD: Power is averaged for each spectral line (i.e., this is a mean-square average of voltage). For the Spectrum result only, if the display transform is linear or real, the RMS result is displayed.
Time	Main Time: Individual time samples in the current time record are averaged vectorially (not RMS) with corresponding points in previous time records. See “Main Time” on page 1734 for more details.
Max	Spectrum, PSD: Not strictly an average. For each spectral line, power from the current measurement is compared to the average buffer value and the maximum is kept in the average buffer.

Common Measurement Functions 2

Some measurement results are inherently averaged, and are not affected by the Average controls. These are: CCDF, CDF, and PDF. They average continuously until the next measurement restart.

Key Path	Meas Setup, Average Setup
Mode	VSA, LTE, LTETDD, IDEN
Measurement	<meas>:=VECTor ADEMod DDEMod W11A W11B EVM IPOWer IDEMod MOTotalk
Remote Command	[:SENSe] : <meas> : AVERage : TYPE RMS TIME MAXimum [:SENSe] : <meas> : AVERage : TYPE?
Example	VECT:AVER:TYPE RMS VECT:AVER:TYPE?
Preset	RMS
State Saved	Saved in instrument state.
Range	RMS Time Max
Initial S/W Revision	Prior to A.02.00
Modified at S/W Revision	A.02.00

Fast Average

Fast average controls the display of average data. If fast averaging is off, then the display is updated after each time record is processed. If fast averaging is on, then the display is only updated after every M records, where M is the Update Rate (see below). For example, if the fast average count is 10, then the running average is only displayed every 10th time record.

Key Path	Meas Setup, Average Setup
Mode	VSA, LTE, LTETDD, IDEN
Measurement	<meas>:=VECTor ADEMod DDEMod W11A W11B EVM IPOWer IDEMod MOTotalk
Remote Command	[:SENSe] : <meas> : AVERage : FAST OFF ON 0 1 [:SENSe] : <meas> : AVERage : FAST?
Example	VECT:AVER:FAST ON VECT:AVER:FAST?
Preset	OFF
State Saved	Saved in instrument state.
Range	On Off
Initial S/W Revision	Prior to A.02.00
Modified at S/W Revision	A.02.00

Update Rate

The Update Rate controls how often the display updates when fast averaging is turned on. If the Fast Averaging State is MAX then the display is updated only after the full Average Count is reached. Otherwise, the display is updated whenever the average count is a multiple of the Update Rate..

Key Path	Meas Setup, More, Average Setup
Mode	VSA, LTE, LTETDD, IDEN
Measurement	<meas>:=VECTor ADEMod DDEMod W11A W11B EVM IPOWER IDEMod MOTotalk
Remote Command	[:SENSe] : <meas> : AVERage : FAST : URATe <integer> [:SENSe] : <meas> : AVERage : FAST : URATe? [:SENSe] : <meas> : AVERage : FAST : URATe : AUTO OFF ON 0 1 [:SENSe] : <meas> : AVERage : FAST : URATe : AUTO?
Example	VECT: AVER: FAST: URAT 20 VECT: AVER: FAST: URAT? VECT: AVER: FAST: URAT: AUTO ON VECT: AVER: FAST: URAT: AUTO?
Preset	10 ON
State Saved	Saved in instrument state.
Min	1
Max	2147483647
Initial S/W Revision	Prior to A.02.00
Modified at S/W Revision	A.02.00

PhNoise Opt

Allows you to adjust the LO phase noise optimization to give better close-in phase noise, or better wide-offset phase noise. The definition of what frequency offsets constitute close in or wide offset varies with hardware. (The selection keys provide hardware-specific prompts.)

Key Path	Meas Setup
Mode	VSA, WIMAXFIXED
Measurement	<meas>:=VECTor ADEMod DDEMod W11A W11B EVM
Remote Command	[:SENSe] : <meas> : FREQuency : SYNThesis [:STATe] 1 2 [:SENSe] : <meas> : FREQuency : SYNThesis [:STATe] ?

Common Measurement Functions 2

Example	VECT:FREQ:SYNT 1 VECT:FREQ:SYNT?
Notes	Parameter key: 1 - optimizes phase noise for close-in frequencies 2 - optimizes phase noise for wide-offset frequencies The softkey shows the options more explicitly. For MXA/EXA, the selection keys show the options: Best Close-in Φ Noise [offset < 20 kHz] Best Wide-offset Φ Noise [offset > 30 kHz] For PXA the options are: Best Close-in Φ Noise [offset < 140 kHz] Best Wide-offset Φ Noise [offset > 160 kHz]
Preset	all VXA measurements: Best Wide-offset Φ Noise WIMAXFIXED EVM measurement: Best Close-in Φ Noise
State Saved	Saved in instrument state.
Initial S/W Revision	A.04.00

Best Close-in Φ Noise

The LO phase noise is optimized for smaller offsets from the carrier, at the expense of phase noise farther out. For MXA, close in means offsets < 20 kHz; for PXA, it means offsets < 140 kHz.

Key Path	Meas Setup, PhNoise Opt
Mode	VSA, WIMAXFIXED
Example	VECT:FREQ:SYNT 1 VECT:FREQ:SYNT?
Readback	Close-in
Initial S/W Revision	A.04.00

Best Wide-offset Φ Noise

The LO phase noise is optimized for wider offsets from the carrier, at the expense of phase noise closer in. For MXA, wide-offset means offsets > 30 kHz; for PXA, it means offsets > 160 kHz.

Key Path	Meas Setup, PhNoise Opt
Mode	VSA, WIMAXFIXED
Example	VECT:FREQ:SYNT 2 VECT:FREQ:SYNT?

Readback	Wide-offset
Initial S/W Revision	A.04.00

Mode Setup

This key accesses a menu allowing you to set various paramagnets for all VSA measurements.

Key Path	Front Panel
Mode	VSA
Initial S/W Revision	A.01060 or later

Spectrum

This function determines if the spectrum of the incoming data is mirrored or not. The actual mirroring is accomplished by conjugating the complex time data.

Key Path	Mode
Mode	VSA
Remote Command	[:SENSe] :SPECTrum NORMal INVert [:SENSe] :SPECTrum?
Example	SPEC INV SPEC?
Preset	NORM
State Saved	Saved in instrument state.
Range	Normal Invert
Initial S/W Revision	A.01060 or later

Fixed Equalization

Fixed Equalization allows you to apply a fixed FIR equalization filter to the time data, before it is used in further analysis. You define the filter by its frequency response rather than by its impulse response. The frequency response must be stored in a data register.

Key Path	Mode Setup
Mode	VSA
Initial S/W Revision	A.01060 or later

Fixed EQ Mode

This allows you to turn fixed equalization off, on in normal mode, or on in inverted mode. The effect of

Common Measurement Functions 2

Normal mode is to divide the spectrum of the unequalized data by the frequency response in the data register. Invert mode multiplies instead of dividing.

Key Path	Meas Setup, Fixed Equalization
Mode	VSA
Remote Command	[:SENSE]:CORRection:FEQualizer OFF NORMal INVert [:SENSE]:CORRection:FEQualizer?
Example	CORR:FEQ NORM CORR:FEQ?
Preset	OFF
State Saved	Saved in instrument state.
Range	Off Normal Invert
Initial S/W Revision	A.01060 or later

Freq Response Register

This allows you to choose a register that contains the frequency response information for fixed equalization.

Key Path	Meas Setup, Fixed Equalization
Mode	VSA
Remote Command	[:SENSE]:CORRection:FEQualizer:REGister D1 D2 D3 D4 D5 D6 [:SENSE]:CORRection:FEQualizer:REGister?
Example	CORR:FEQ:REG D2 CORR:FEQ:REG?
Preset	D1
State Saved	Saved in instrument state.
Range	Data 1 Data 2 Data 3 Data 4 Data 5 Data 6
Initial S/W Revision	A.01060 or later

Fixed Equalization Mapping

This read-only SCPI function allows you to determine if fixed equalization is applied using relative or absolute frequency mapping between the current measurement span and the span of the frequency response data in the chosen register.

If possible, the equalizer response is defined using the portion of the register data that falls within the

current measurement span. For example, if the data register covers frequencies from 200 MHz to 236 MHz, and the measurement span is 6 MHz wide centered at 210 MHz, then the register data from 207 MHz to 213 MHz is used to define the equalizer response. This is an example of absolute frequency mapping.

If the same register data is used but measurement center frequency is then changed to 70 MHz, then relative frequency mapping must be used. The center frequency of the register data is mapped to the measurement center frequency, and an equivalent span of data is taken. In this example, register data from 215 MHz to 221 MHz is used as though it covered a frequency span of 67 MHz to 73 MHz.

Relative frequency mapping is used if some or all of the measurement span falls outside the data register's frequency span. It can be desirable when measuring across frequency converters, but can be surprising otherwise. Be careful to use a measurement span that is equal to or narrower than the span of the data register.

Mode	VSA
Remote Command	[:SENSe]:CORRection:FEQualizer:RELative?
Example	CORR:FEQ:REL?
Notes	Returns 1 if fixed equalizer frequency mapping is relative; 0 otherwise.
Initial S/W Revision	A.01060 or later

IF Path

Allows user to manually among different IF Paths, or to choose Auto selection.

The selections are 10 MHz, 25 MHz, 40 MHz, and 140 MHz paths. However, depending on the model or options some of these paths might not be available.

Key Path	Mode Setup
Mode	VSA
Remote Command	[:SENSe]:IFPath B10M B25M B40M B140M [:SENSe]:IFPath? [:SENSe]:IFPath:AUTO ON OFF 1 0 [:SENSe]:IFPath:AUTO?
Example	IFP B25M IFP? IFP:AUTO ON IFP:AUTO?

Common Measurement Functions 2

Notes	<p>If a path is not installed or licensed, the associated softkey is blanked. If you try to set the path to an unavailable value via SCPI, it returns error –241, "Hardware missing; Option not installed".</p> <p>When Auto is turned on, the IF Path changes to the narrowest bandwidth that will support the currently selected Span.</p> <p>The query form of this command may be used to determine what path is currently selected when IF Path Auto is turned on.</p>
Dependencies	Greyed out if I/O input is set to I/Q
Couplings	<p>If you select the IF path manually, then IF Path Auto is turned off.</p> <p>Max Span is equal to the IF Path bandwidth. If IF Path Auto is On, then Max Span is equal to the bandwidth of the widest available IF Path.</p> <p>Measurement preset does not affect IF Path or IF Path Auto settings, but the measurement preset values of Span and RBW are affected by these settings.</p> <p>IF Path Auto is turned off by manually selecting the IF Path via front panel or SCPI</p>
Preset	Mode preset turns IF Path Auto on, which selects the widest available IF Path
State Saved	Saved in instrument state.
Range	B10M B25M B40M B140
Readback	10 MHz 25 MHz 40 MHz 140 MHz
Initial S/W Revision	A.04.00

Peak Search

The Peak Search hardkey displays a menu that allows markers to be easily moved among peaks on a trace, and also performs the peak search function, as described below. Pressing Peak Search also makes the selected marker's X position the active function.

The peak search function causes the marker to move to the highest point in the trace. The highest point is the point with the largest y-axis value in the current trace format. If the format is complex (vector or constellation) then the point with the highest magnitude is chosen.

Pressing the Peak Search hard key always performs a Peak Search, with one exception: if the Peak Search menu is not showing but the selected marker is on (Normal, Delta, or Fixed), then pressing the Peak Search hardkey only displays the Peak Search menu. This allows you to select one of the other peak search functions without disturbing the selected marker's position. If you want to perform a peak search in this case, press the Peak Search hardkey again.

If the selected marker is Off, then pressing the Peak Search hardkey once not only shows the menu, but it turns on the selected marker in Normal mode, assigns it to the selected trace, and performs a peak search.

If any peak search SCPI command is invoked on a marker that is Off, the marker is first turned on in Normal mode and assigned to the selected trace. Then the peak search is performed.

Key Path	Peak Search (press hardkey twice if menu is not showing)
----------	---

Mode	VSA, LTE, LTETDD, IDEN
Measurement	<meas>:=VECTor ADEMod DDEMod W11A W11B EVM IPOWer IDEMod MOTotalk
Remote Command	:CALCulate:<meas>:MARKer[1] 2 3 4 5 6 7 8 9 10 11 12: MAXimum
Example	CALC:VECT:MARK2:MAX
Notes	There is no softkey for this function. Instead, you press the Peak Search hardkey twice. (Pressing it once is sufficient if the Peak Search menu is showing, but twice guarantees that the function will be invoked) If peak search function is not invoked (because the response to pressing the hardkey was only to show the menu) then the following message is shown: "Press Peak Search again to perform a Peak Search."
Initial S/W Revision	Prior to A.02.00
Modified at S/W Revision	A.02.00

Next Peak (Next Lower Amptd)

This command moves the marker to the peak next lower in Y value than the peak it is currently on. If the format is complex (vector or constellation) then the marker moves to the closest point that has a lower magnitude than the marker's current position. If this function is invoked via SCPI on a marker that is off, the result is the same as if you sent a Peak Search command.

Key Path	Peak Search
Mode	VSA, LTE, LTETDD, IDEN
Measurement	<meas>:=VECTor ADEMod DDEMod W11A W11B EVM IPOWer IDEMod MOTotalk
Remote Command	:CALCulate:<meas>:MARKer[1] 2 3 4 5 6 7 8 9 10 11 12: MAXimum:NEXT
Example	CALC:VECT:MARK2:MAX:NEXT
Initial S/W Revision	Prior to A.02.00
Modified at S/W Revision	A.02.00

Next Higher Amptd

This command moves the marker to the peak next higher in Y value than the peak it is currently on. . If the format is complex (vector or constellation) then the marker moves to the closest point that has a higher magnitude than the marker's current position. If this function is invoked via SCPI on a marker that is off, the result is the same as if you sent a Peak Search command.

Key Path	Peak Search
Mode	VSA, LTE, LTETDD, IDEN

Common Measurement Functions 2

Measurement	<meas>:=VECTor ADEMod DDEMod W11A W11B EVM IPOWER IDEMod MOTotalk
Remote Command	:CALCulate:<meas>:MARKer[1] 2 3 4 5 6 7 8 9 10 11 12: MAXimum:PREVIOUS
Example	CALC:VECT:MARK2:MAX:PREV
Initial S/W Revision	Prior to A.02.00
Modified at S/W Revision	A.02.00

Next Right

This command moves the marker to the next peak to the right of its current position. If the format is complex (vector or constellation) then the marker moves forward in time to the next peak. If this function is invoked via SCPI on a marker that is off, the result is the same as if you sent a Peak Search command.

A valid peak is one for which the displayed Y-axis values drop monotonically on both sides of the local maximum at least 4% of the distance between the top and bottom of the display grid before the values begin to rise again.

Key Path	Peak Search
Mode	VSA, LTE, LTETDD, IDEN
Measurement	<meas>:=VECTor ADEMod DDEMod W11A W11B EVM IPOWER IDEMod MOTotalk
Remote Command	:CALCulate:<meas>:MARKer[1] 2 3 4 5 6 7 8 9 10 11 12: MAXimum:RIGHT
Example	CALC:VECT:MARK2:MAX:RIGH
Initial S/W Revision	Prior to A.02.00
Modified at S/W Revision	A.02.00

Next Left

This command moves the marker to the next peak to the left of its current position. If the format is complex (vector or constellation) then the marker moves back in time to the next peak. If this function is invoked via SCPI on a marker that is off, the result is the same as if you sent a Peak Search command.

A valid peak is one for which the displayed Y-axis values drop monotonically on both sides of the local maximum at least 4% of the distance between the top and bottom of the display grid before the values begin to rise again.

Key Path	Peak Search
Mode	VSA, LTE, LTETDD, IDEN
Measurement	<meas>:=VECTor ADEMod DDEMod W11A W11B EVM IPOWER IDEMod MOTotalk

Remote Command	:CALCulate:<meas>:MARKer[1] 2 3 4 5 6 7 8 9 10 11 12: MAXimum:LEFT
Example	CALC:VECT:MARK2:MAX:LEFT
Initial S/W Revision	Prior to A.02.00
Modified at S/W Revision	A.02.00

Mkr -> CF (Center Frequency)

This key is a duplicate of the key of the same name in the Mkr -> menu. It is placed in this menu as a convenience. See the description in the Marker To section.

Key Path	Peak Search
Mode	VSA, LTE, LTETDD, IDEN
Initial S/W Revision	Prior to A.02.00
Modified at S/W Revision	A.02.00

Continuous Peak Search

This key turns on Continuous Peak Search for the selected marker. This function be turned on for any marker independently of any other marker. This function moves the marker to the highest point on the trace each time the trace is updated. If the SCPI command refers to a marker that is off, it is turned on in Normal mode.

It is possible to have Couple Markers and Continuous Peak Search both on. If this is the case, it is recommended that Continuous Peak search be turned on for only one marker in any tracking set (that is, any set of markers with the same or equivalent domain). Otherwise, conflicts over marker position may arise that cause erratic marker movement.

Key Path	Peak Search
Mode	VSA, LTE, LTETDD, IDEN
Measurement	<meas>:=VECTor ADEMod DDEMod W11A W11B EVM IPOWER IDEMod MOTotalk
Remote Command	:CALCulate:<meas>:MARKer[1] 2 3 4 5 6 7 8 9 10 11 12: CPSearch[:STATE] ON OFF 1 0 :CALCulate:<meas>:MARKer[1] 2 3 4 5 6 7 8 9 10 11 12: CPSearch[:STATE]?
Example	CALC:VECT:MARK1:CPS ON
Couplings	The Continuous Peak Search key is grayed out when the selected marker is a Fixed marker. Also, if Continuous Peak Search is on and the selected marker becomes a fixed marker, then Continuous Peak Search is turned off and the key grayed out. Continuous Peak Search is turned off when the selected marker is turned off.

Common Measurement Functions 2

Preset	OFF
State Saved	Saved in instrument state.
Range	Off On
Initial S/W Revision	Prior to A.02.00
Modified at S/W Revision	A.02.00

Min Search

This command moves the marker to the lowest Y value on the trace. If the format is complex (vector or constellation) then the marker moves to the lowest value in magnitude. If the SCPI command refers to a marker that is off, it is first turned on in Normal mode and then set on the minimum point.

Key Path	Peak Search
Mode	VSA, LTE, LTETDD, IDEN
Measurement	<meas>:=VECTor ADEMod DDEMod W11A W11B EVM IPOWer IDEMod MOTotalk
Remote Command	:CALCulate:<meas>:MARKer[1] 2 3 4 5 6 7 8 9 10 11 12: MINimum
Example	CALC:VECT:MARK2:MIN
Initial S/W Revision	Prior to A.02.00
Modified at S/W Revision	A.02.00

Mkr -> Ref Lvl (Reference Level)

This function sets the Y axis reference value equal to the selected marker's Y value. For example, if the reference position is at the top of the screen, the whole trace is moved up so that the marker appears at the top of the screen. Note that this is a display scaling function only. The input range remains the same.

Key Path	Peak Search
Mode	VSA, LTE, LTETDD, IDEN
Initial S/W Revision	Prior to A.02.00
Modified at S/W Revision	A.02.00

Recall

Operation of this key is identical across several measurements. For more details about this key, see [“Recall” on page 194](#).

State

Key Path	Recall
Mode	VSA, LTE, LTETDD, IDEN

Data (Import)

Key Path	Recall
Mode	VSA, LTE, LTETDD, IDEN

Import Trace Data

This selection allows you to import previously saved trace data into a Data Register and optionally display it. Selecting this key displays a menu that allows you to select the destination data register, and also allows you to choose whether or not to display the recalled data in the currently selected trace. After making these selections depress Open... and use the file dialog to select the file you wish to recall.

Recalling trace data into an already used Data Register overwrites the previous data. If the data register is displayed on any trace, the display is updated to reflect the new data.

The SCPI command

`:MMEM:LOAD:TRAC:DATA D1|D2|D3|D4|D5|D6,<filename>`

recalls data into a specified register, but does not display it in the selected trace. Use the command

`:DISP:<meas>:TRAC<n>:FEED D1|D2|D3|D4|D5|D6`

to display the register in the desired trace.

It is possible to recall trace data saved by other VXA measurements, or measurements made using the LTE, LTETDD, iDEN, or 89601 applications.

Key Path	Recall, Data (Import)
Mode	VSA, LTE, LTETDD, IDEN
Remote Command	<code>:MMEMory:LOAD:TRACe:DATA D1 D2 D3 D4 D5 D6 , <filename> [, CSV TXT SDF MAT4 MAT HDF5 BIN]</code>
Example	<code>:MMEM:LOAD:TRAC:DATA D1,"Trc1.txt",TXT</code>

Common Measurement Functions 2

Notes	<p>The Open: dialog box has the following filter options when you are recalling trace data::</p> <ul style="list-style-type: none"> • CSV (Comma delimited) (*.csv) • SDF (Fast) (*.sdf;*.dat) • Text (Tab delimited) (*.txt) <p>The file must have the same format as that created by the Export Recorded Data command.</p> <p>The SCPI command has an optional file format parameter. If you do not include this parameter in the SCPI command, the file format is determined by the file name extension. If no file extension is recognized, the file is scanned to determine the format.</p> <p>If you are not licensed to recall a particular file type, then error –203.9010 will be returned. If the file format cannot be determined or the file cannot be recalled successfully, then error –250.5290 is returned. If the recall is successful, then advisory 0.1600 is shown.</p>
State Saved	No
Readback	Data 1 Data 2 Data 3 Data 4 Data 5 Data 6

Data 1

Selects the Data 1 register as the destination for the imported data

Key Path	Recall, Data (Import), Trace (to)
Mode	VSA, LTE, LTETDD, IDEN

Data 2

Selects the Data 2 register as the destination for the imported data

Key Path	Recall, Data (Import), Trace (to)
Mode	VSA, LTE, LTETDD, IDEN

Data 3

Selects the Data 3 register as the destination for the imported data

Key Path	Recall, Data (Import), Trace (to)
Mode	VSA, LTE, LTETDD, IDEN

Data 4

Selects the Data 4 register as the destination for the imported data

Key Path	Recall, Data (Import), Trace (to)
Mode	VSA, LTE, LTETDD, IDEN

Data 5

Selects the Data 5 register as the destination for the imported data

Key Path	Recall, Data (Import), Trace (to)
Mode	VSA, LTE, LTETDD, IDEN

Data 6

Selects the Data 6 register as the destination for the imported data

Key Path	Recall, Data (Import), Trace (to)
Mode	VSA, LTE, LTETDD, IDEN

Display in Selected Trace

Allows you to select whether the recalled trace data is to be displayed in the current Trace.

Key Path	Recall, Data (Import), Trace (to)
Mode	VSA, LTE, LTETDD, IDEN
State Saved	No

Open ...

Key Path	Recall, Data (Import)
Mode	VSA, LTE, LTETDD, IDEN

Save

See [“Save” on page 207](#) in the section "Common Measurement Functions" for more information.

State

Key Path	Save
Mode	VSA, LTE, LTETDD, IDEN

Data (Export)

Key Path	Save
Mode	VSA, LTE, LTETDD, IDEN

Common Measurement Functions 2

Export Trace Data

This selection allows you to export trace data with (optional) associated headers. Selecting this key displays a menu that allows you to choose which Trace to save (default is the selected Trace) and whether or not to save headers with the data. The header information is used by the VXA application when saved trace data is recalled, and allows it to be displayed with the same formatting and scaling that it had when saved. If headers are not saved, the scaling and format are set to default values when the trace is recalled. After making these selections, press Save As... and use the file dialog to choose a file name and format for the saved data.

Trace data may be exported in several different formats. Text and comma-separated variable (CSV) formats are useful for viewing the data or importing it to a spreadsheet program. The other formats are binary and thus more compact. Trace data files may be recalled for viewing into other VXA, LTE, LTETDD, iDEN, or 89601 measurements.

Key Path	Save, Data (Export)
Mode	VSA, LTE, LTETDD, IDEN
Remote Command	:MMEMory:STORe:TRACe:DATA TRACE1 TRACE2 TRACE3 TRACE4 TRACE5 TRACE6, "<filename>" [, CSV TXT SDF MAT4 MAT HDF5 BIN[, OFF ON 0 1]]
Example	:MMEM:STOR:TRAC:DATA TRACE1,"TRC1.TXT",TXT,ON
Notes	<p>The Save As... dialog box has the following format options when you are saving trace data:</p> <ul style="list-style-type: none"> • CSV (Comma delimited) (*.csv) • SDF (Fast) (*.sdf;*.dat) • Text (Tab delimited) (*.txt) <p>File format saved depends on selection. The appropriate file extension is appended to the filename if it is not supplied by the user.</p> <p>If the SCPI command includes just a file name, the file format is determined by the filename extension, which must be one of the choices above. *.sdf, or an unrecognized extension chooses the SDF fast format. If the optional file format enumerator is included in the command, then this determines the file format and the file extension is ignored. The optional binary parameter determines if file headers are saved. The default is ON. If file headers are not wanted use the optional “,OFF” parameter.</p> <p>The optional Boolean parameter determines whether headers are saved in the file. By default the headers are saved.</p> <p>If you are not licensed to save a particular file type, then error –203.9010 will be returned. If an invalid file format is specified or the file cannot be saved successfully, then error –25x is returned. If the save is successful, then advisory 0.1500 is shown.</p>
State Saved	No
Readback	(Trace 1 Trace 2 Trace 3 Trace 4 Trace 5 Trace 6)(with without) headers

Trace 1

Selects the Trace 1 register as the destination for the imported data

Key Path	Save, Data (Export), Trace
Mode	VSA, LTE, LTETDD, IDEN

Trace 2

Selects the Trace 2 register as the destination for the imported data

Key Path	Save, Data (Export), Trace
Mode	VSA, LTE, LTETDD, IDEN

Trace 3

Selects the Trace 3 register as the destination for the imported data

Key Path	Save, Data (Export), Trace
Mode	VSA, LTE, LTETDD, IDEN

Trace 4

Selects the Trace 4 register as the destination for the imported data

Key Path	Save, Data (Export), Trace
Mode	VSA, LTE, LTETDD, IDEN

Trace 5

Selects the Trace 5 register as the destination for the imported data

Key Path	Save, Data (Export), Trace
Mode	VSA, LTE, LTETDD, IDEN

Trace 6

Selects the Trace 6 register as the destination for the imported data

Key Path	Save, Data (Export), Trace
Mode	VSA, LTE, LTETDD, IDEN

Include Header

Allows you to select whether or not the saved trace data includes header information describing scaling, formatting, etc.

Key Path	Save, Data (Export), Trace
----------	-----------------------------------

Common Measurement Functions 2

Mode	VSA, LTE, LTETDD, IDEN
State Saved	No

Save As . . .

Key Path	Save, Data (Export)
Mode	VSA, LTE, LTETDD, IDEN

Screen Image . . .

Key Path	Save
Mode	VSA, LTE, LTETDD, IDEN

SPAN X Scale

This menu has softkeys for selecting measurement span and also for scaling of the X axis.

Key Path	Front Panel
Mode	VSA, LTE, LTETDD, IDEN
Initial S/W Revision	Prior to A.02.00
Modified at S/W Revision	A.02.00

Span

This controls the frequency span of the measurement. This is the full span that is displayed on a spectrum display. The actual IF bandwidth that the time record sees is 1.28 times the span. See the **FREQ Channel** section for details on how this interacts with start, stop, and center frequencies.

Key Path	SPAN/XScale
Mode	VSA, IDEN
Remote Command	[:SENSe] :FREQuency:SPAN <freq> [:SENSe] :FREQuency:SPAN?
Example	FREQ:SPAN 10 MHZ FREQ:SPAN?
Couplings	Start Freq and Stop Freq. See narrative under FREQ Channel heading for details.
Preset	depends on span option

State Saved	Saved in instrument state.
Min	2 Hz
Max	depends on span option
Initial S/W Revision	Prior to A.02.00
Modified at S/W Revision	A.02.00

Full Span

This immediate action key changes the span to the maximum available. The center frequency remains unchanged, regardless of whether the Frequency Annotation property is Start/Stop or Center/Span.

Key Path	SPAN/XScale
Mode	VSA, IDEN
Remote Command	[:SENSE] :FREQuency :SPAN :FULL
Example	FREQ:SPAN:FULL
Notes	The label on the softkey gives the full span available, which depends on span option.
Couplings	Changes span to maximum while keeping the center frequency constant. Start and Stop frequency are affected
Readback Text	[25 MHz] If playing back a recording, list the recorded bandwidth here
Initial S/W Revision	Prior to A.02.00
Modified at S/W Revision	A.02.00

Signal Track

From the point of view of a spectrum display, this function, when turned on, attempts to keep the largest magnitude signal in the center of the screen. It is the equivalent of manually doing a single acquisition, doing a marker to peak search on a spectrum trace, then copying the marker position to the center frequency and repeating. (It is not necessary to be viewing a spectrum display for this function to work.)

Key Path	SPAN/XScale
Mode	VSA
Remote Command	[:SENSE] :VECTor ADEMod :FREQuency :CENTer :TRACk OFF ON 0 1 [:SENSE] :VECTor ADEMod :FREQuency :CENTer :TRACk?
Example	VECT:FREQ:CENT:TRAC ON VECT:FREQ:CENT:TRAC?
Couplings	Unavailable if averaging is turned on.
Preset	0

Common Measurement Functions 2

State Saved	Saved in instrument state.
Range	On Off
Initial S/W Revision	Prior to A.02.00

X Axis Scaling

By default, the X axis of a trace is scaled to show all the available data in the trace. (The exception is that in spectrum displays, the edges of the spectrum that may contain aliases are not shown by default.) However, the X axis can be manually scaled in order to zoom in on a subset of the X values, or to set the X scaling to more convenient numbers. X scaling may be changed even when a measurement is paused or completed, and the display will be updated immediately, using the existing trace data. No measurement parameters are affected and no new measurement is made. X scaling is unique to each trace.

Scaling is based on a reference position, which may be on the left of the grid, in the center, or on the right. The X reference value is assigned to this position. The X Width is the difference between the X value on the right side of the grid and the X value on the left. If the reference is in the center, the right and left are half of the X width away.

If X scaling is set such that the left or right axis boundary falls outside the X range of the available data, the trace is shown correctly on that portion of the display where it belongs.

For Vector displays (I-Q and Constellation) the X axis is actually perpendicular to the screen, and the screen's horizontal axis is used for the real part of the Y values. In this case, the X scaling can still be used to only display a portion of the data. In the case of the X reference position, left means the least positive or most negative X value, and right means the most positive or least negative value. For example, when looking at a 10 ms time record of a QPSK signal, you could set the X reference position to left, the X reference value to 4 ms and the X width to 1 ms in order to see just the portion of the signal between 4 and 5 ms. This same portion would be shown if IQ format were chosen (even though the time axis is not visible in this case).

For Symbol tables, which are not graphed but displayed in alphanumeric, X scaling can also be used to display a portion of the complete data. For example, you can set the X reference position to left, the X reference value to 20 symbols, and the X width to 10 symbols to see symbols 20 through 30. If then change the X reference position to center, you will see symbols 15 through 25, and if you change the X reference position to right you will see symbols 10 through 20.

Annotation for the X axis is just below the grid on the left and right side. It is based on whether the X Scaling is Auto or Man. If it is Auto, then the left side is annotated with either "Center" or "Start", and the right side is annotated with either "Span" or "Stop" followed by the appropriate numbers and units. The Center/ Span pair is only used for Spectrum or PSD traces, and only if the Freq Annotation property is Center/Span (see Freq Annotation under the FREQ key).

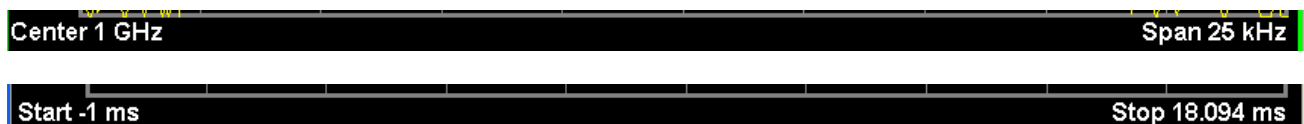

If X Scaling is Man, the annotation for the left side is "Left|Ctr|Right <x_reference_value> <unit>" (depending on the X reference position), and on the right side the annotation is "Width <x_width> <unit>". Shown below is an illustration of two of these manual X scale annotations:

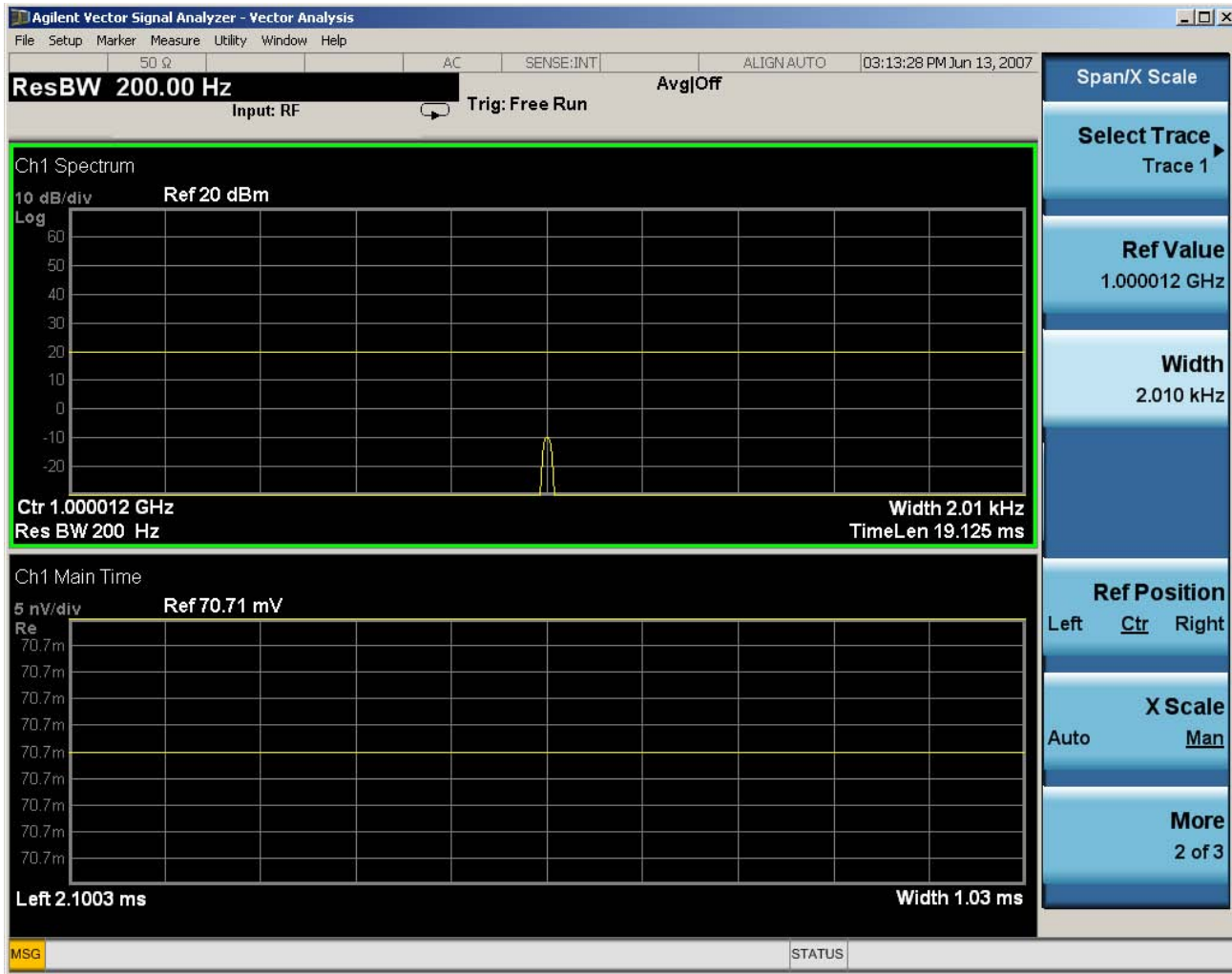

For Vector displays, the X axis annotation is replaced by annotation for the real part of the Y value, each annotation consisting of number followed by a unit (usually volts).

Key Path	SPAN X Scale
Mode	VSA, LTE, LTETDD, IDEN
Initial S/W Revision	Prior to A.02.00
Modified at S/W Revision	A.02.00

Select Trace

This function is a duplicate of the same function found on the Trace/Detector menu. See the description there for details. It is placed here to allow you to conveniently choose which trace the X scaling applies.

Key Path	SPAN X Scale, X Axis Scaling
Mode	VSA, LTE, LTETDD, IDEN
Initial S/W Revision	Prior to A.02.00

Common Measurement Functions 2

Modified at S/W Revision	A.02.00
--------------------------	---------

X Scale

If this function is set to Auto, it causes the trace to display all available trace data. (Exception: the display of the outer edges of a spectrum which may contain aliases is governed by the All Frequency Points function setting – see below.). The annotation is updated as needed, but the X Reference Value and X Width keys are grayed out and not updated. When this function is set to Man, the X Reference Value and X Width softkey readbacks are updated with the current values.

Key Path	SPAN/XScale
Mode	VSA, LTE, LTETDD, IDEN
Measurement	<meas>:=VECTor ADEMod DDEMod W11A W11B EVM IPOWer IDEMod MOTotalk
Remote Command	:DISPlay:<meas>:TRACe[1] 2 3 4:X[:SCALe]:COUPle OFF ON 0 1 :DISPlay:<meas>:TRACe[1] 2 3 4:X[:SCALe]:COUPle?
Example	:DISP:VECT:TRAC1:X:COUP ON DISP:VECT:TRAC1:X:COUP?
Couplings	Forced to Man if X Reference Value or X Width is set by user.
Preset	1
State Saved	Saved in instrument state.
Range	Auto Man
Initial S/W Revision	Prior to A.02.00
Modified at S/W Revision	A.02.00

X Reference Value

This function controls the X value of the selected trace at the chosen X Reference Position (see below). It has no effect on hardware input settings.

Key Path	SPAN/XScale
Mode	VSA, LTE, LTETDD, IDEN
Measurement	<meas>:=VECTor ADEMod DDEMod W11A W11B EVM IPOWer IDEMod MOTotalk
Remote Command	:DISPlay:<meas>:TRACe[1] 2 3 4:X[:SCALe]:RLEVel <real> :DISPlay:<meas>:TRACe[1] 2 3 4:X[:SCALe]:RLEVel?
Example	DISP:VECT:TRAC:X:RLEV 1e9 DISP:VECT:TRAC:X:RLEV?

Couplings	If X Scale is set to Auto, the X Reference Value is determined by the trace data and this key is grayed out.
Preset	Depends on trace
State Saved	Saved in instrument state.
Min	-9.9E+37
Max	9.9E+37
Initial S/W Revision	Prior to A.02.00
Modified at S/W Revision	A.02.00

X Width

This sets the width of the X axis that is displayed for the selected trace. The X width may be set less than the Span for frequency-domain traces, allowing you to zoom in on just a portion of the measured values. Likewise it may be less than time span covered by time-domain data. This plus the X Reference Value and X Reference Position control the range of X values that may be displayed on a trace. For example, if the X Reference position is Center, the X Reference value is 1 GHz and the X Width is 20 MHz.

Key Path	SPAN/XScale
Mode	VSA, LTE, LTETDD, IDEN
Measurement	<meas>:=VECTor ADEMod DDEMod W11A W11B EVM IPOWER IDEMod MOTotalk
Remote Command	:DISPlay:<meas>:TRACe[1] 2 3 4:X[:SCALE]:SPAN <real> :DISPlay:<meas>:TRACe[1] 2 3 4:X[:SCALE]:SPAN?
Example	DISP:VECT:TRAC:X:SPAN 10e6 DISP:VECT:TRAC:X:SPAN?
Couplings	If X Scale is set to Auto, the X Width is determined by the trace data and this key is grayed out.
Preset	Depends on trace
State Saved	Saved in instrument state.
Min	-9.9E+37
Max	9.9E+37
Initial S/W Revision	Prior to A.02.00
Modified at S/W Revision	A.02.00

X Reference Position

This determines the position from which the X scaling is calculated for the selected trace. It may be set to

Common Measurement Functions 2

the left side, center, or right side of the grid.

Key Path	SPAN/XScale
Mode	VSA, LTE, LTETDD, IDEN
Measurement	<meas>:=VECTor ADEMod DDEMod W11A W11B EVM IPOWer IDEMod MOTotalk
Remote Command	:DISPlay:<meas>:TRACe[1] 2 3 4:X[:SCALe]:RPOSition LEFT CENTer RIGHT :DISPlay:<meas>:TRACe[1] 2 3 4:X[:SCALe]:RPOSition?
Example	DISP:VECT:TRAC1:X:RPOS LEFT DISP:VECT:TRAC1:X:RPOS?
Couplings	If X Scale is set to Auto, the X Reference Position is determined by the trace data and this key is grayed out.
Preset	CENT
State Saved	Saved in instrument state.
Range	Left Ctr Right
Initial S/W Revision	Prior to A.02.00
Modified at S/W Revision	A.02.00

All Frequency Points

Spectrum trace data (and PSD) are based on the FFT algorithm. By default, the outer edges of the spectrum are not displayed because they may show spurious results that are aliases of real signals that are not completely filtered out by the IF filter. For example, in the case of a 1024 point FFT only 801 points are displayed. If you want to view the additional FFT points at the edges of spectral displays, turn this function on. It is global to all traces, not specific to a single trace.

Key Path	SPAN/XScale
Mode	VSA, LTE, LTETDD, IDEN
Measurement	<meas>:=VECTor ADEMod DDEMod W11A W11B EVM IPOWer IDEMod MOTotalk
Remote Command	:DISPlay:<meas>:AFPoints OFF ON 0 1 :DISPlay:<meas>:AFPoints?
Example	DISP:VECT:AFP ON DISP:VECT:AFP?
Notes	ac
Couplings	Only applies if trace is showing Spectrum or PSD results.
Preset	OFF

State Saved	Saved in instrument state.
Range	On Off
Initial S/W Revision	Prior to A.02.00
Modified at S/W Revision	A.02.00

Freq Annotation

This controls how Spectrum and PSD traces are annotated when their X Scale is set to Auto. If Freq Annotation is set to Center/Span, the X-axes on windows containing frequency domain traces are labeled with the center frequency on the left and the span on the right. If the Freq Annotation is set to Start/Stop, then the start and stop frequencies appear in place of center and span. If the X Scale is manual, then this annotation style does not apply.

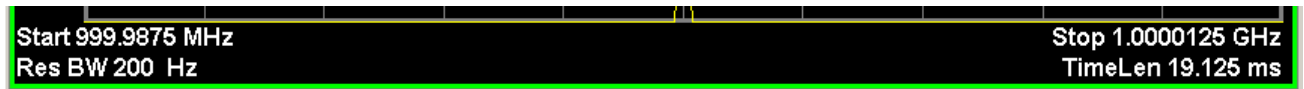
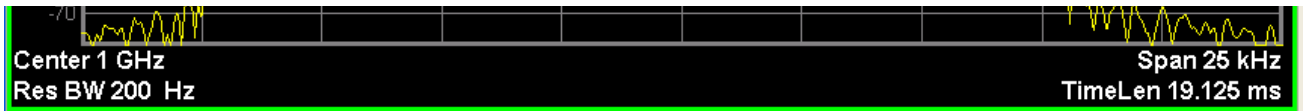

Key Path	SPAN/XScale
Mode	VSA, LTE, LTETDD, IDEN
Measurement	<meas>:=VECTor ADEMod DDEMod W11A W11B EVM IPOWer IDEMod MOTotalk
Remote Command	:DISPlay:<meas>:FANNotation CSPan SSTop :DISPlay:<meas>:FANNotation?
Example	DISP:VECT:FANN CSP DISP:VECT:FANN?
Preset	CSP
State Saved	Saved in instrument state.
Range	Center/Span Start/Stop
Initial S/W Revision	Prior to A.02.00
Modified at S/W Revision	A.02.00

Copy X Scale

This front-panel only function copies the following X scaling information from the selected trace to another:

- X reference Position
- X Reference Value

Common Measurement Functions 2

- X Width
- X Scale (Auto/Man)

Key Path	SPAN X Scale, X Axis Scaling
Mode	VSA, LTE, LTETDD, IDEN
Initial S/W Revision	Prior to A.02.00
Modified at S/W Revision	A.02.00

Sweep/Control

This key displays a menu allowing you to control time-related measurement parameters, and to pause or resume the measurement.

Key Path	Front Panel
Mode	VSA
Initial S/W Revision	A.01060 or later

Main Time

This key allows you to control the length of the overall time record used in the measurement. Note that the Gate function (see below) allows you to analyze only a portion of the displayed Main Time. Time length and Res BW are related by the following equation:

$$\text{Res BW} = \text{ENBW} / T$$

where ENBW is the normalized effective noise bandwidth of the Window (see the FFT Window topic under BW for more details).and T is the time record length (in seconds).

Therefore, if you change Main Time, the Resolution bandwidth must also change, and vice versa.

Time record size (in sample points) can vary between 16 points and the full FFT size used for spectrum calculations. The FFT size is indirectly chosen by setting Freq Points (see below) and is equal to $(\text{Freq Points} - 1) * 1.28$.

Main Time length (in seconds) is the time record size times the sample period. The sample period for the Main Time result is $1/(1.28 * \text{Span})$.

Limits:

The maximum Main Time length is:

$$\text{Max FFT size} / (1.28 * \text{Span}) = (409600)/\text{Span} \quad \text{if Freq points state parameter is set to Auto}$$

$$\text{FFT size} / (1.28 * \text{Span}) = (\text{Freq Points} - 1)/\text{Span} \quad \text{if Freq points parameter is manually set}$$

Note that the minimum Res BW is related to maximum Main Time length.

The minimum Main Time length is

$$16 \text{ points} / (1.28 * \text{Span}) = 12.5/\text{Span}$$

See Res BW and Res BW Coupling sections for details on couplings that can change Main Time length due to Res BW changes.

Key Path	Sweep Control
Mode	VSA
Measurement	<meas>:=VECTor ADEMod
Remote Command	[:SENSe] : <meas> : SWEep : TIME <time> [:SENSe] : <meas> : SWEep : TIME?
Example	VECT:SWE:TIME 3 MS VECT:SWE:TIME?
Notes	This key is not available in measurements other than Vector or Analog Demod. The annotation is shown, however. In other measurements the time length is determined by number of symbols.
Couplings	Affected by Res BW, Span, Freq Points, and Window. See Res BW and Res BW coupling sections for details.
Preset	12.75e-6
State Saved	Saved in instrument state.
Min	-9.9e37
Max	9.9e37
Initial S/W Revision	A.01060 or later

Pause / Resume

Pauses or resumes acquisition at the end of the current time record acquisition.

For more information see the Measurement Functions, Sweep/Control for a description of this function.

Key Path	Sweep Control
Mode	VSA
Initial S/W Revision	A.01060 or later

Abort

This key is a duplicate of the Abort key in the Input/Output, Data Source menu.

Gate

This key accesses a menu of time gating control functions. Time gating lets you isolate a portion of a Main Time record to be used for downstream spectrum and statistical analysis (instead of the whole time record). The gate position may be changed during a stopped measurement and the instantaneous gate time and spectrum traces update immediately. Averages are restarted when gate properties change. The windowing function used in gated measurements is the same as non-gated measurements.

Common Measurement Functions 2

For more information see the Measurement Functions, Sweep/Control, Gate for a description of this function.

Key Path	Sweep Control
Mode	VSA
Initial S/W Revision	A.01060 or later

Gate

This Boolean softkey turns time gating on or off

Key Path	Sweep/Control
Mode	VSA
Measurement	<meas>:=VECTor ADEMod
Remote Command	[:SENSe] : <meas> : SWEep : EGATe : STATe OFF ON 0 1 [:SENSe] : <meas> : SWEep : EGATe : STATe?
Example	VECT:SWE:EGAT:STAT ON VECT:SWE:EGAT:STAT?
Preset	0
State Saved	Saved in instrument state.
Initial S/W Revision	A.01060 or later

Gate Length

This adjusts the time between the beginning and the end of the gate.

Key Path	Sweep/Control
Mode	VSA
Measurement	<meas>:=VECTor ADEMod
Remote Command	[:SENSe] : <meas> : SWEep : EGATe [:SPAN] <time> [:SENSe] : <meas> : SWEep : EGATe [:SPAN] ?
Example	VECT:SWE:EGAT 2 MS VECT:SWE:EGAT?
Couplings	Gate length and delay are limited so that the gate always falls within the current time record. If the time record length decreases, the gate delay is limited first, then the gate length.
Preset	1.28125e-6
State Saved	Saved in instrument state.

Min	16 time samples
Max	Time record length
Initial S/W Revision	A.01060 or later

Gate Delay

This adjusts the time between the start of the time record and the beginning of the gate .

Key Path	Sweep/Control
Mode	VSA
Measurement	<meas>:=VECTor ADEMod
Remote Command	[:SENSe] : <meas> : SWEep : EGATe : DELay <time> [:SENSe] : <meas> : SWEep : EGATe : DELay?
Example	VECT:SWE:EGAT:DEL 500 US VECT:SWE:EGAT:DEL?
Couplings	Gate length and delay are limited so that the gate always falls within the current time record. If the time record length decreases, the gate delay is limited first, then the gate length.
Preset	0
State Saved	Saved in instrument state.
Min	0
Max	Time record length – gate length
Initial S/W Revision	A.01060 or later

Freq Points

By default, the analyzer chooses the number of Freq Points displayed in Spectrum or PSD displays, depending on the Res BW or Main Time length chosen. This softkey allows you to manually enter the number of displayed frequency points. Auto mode is recommended. The number of Freq Points is related to the number of FFT points used in spectrum calculations (which is always a power of 2).

$$\text{Freq Points} = (\text{FFT points})/1.28 + 1$$

Note that if All Frequency Points is turned on for a selected trace, then all computed FFT points are shown. (See SPAN/X scale, All Frequency Points.)

Key Path	Sweep Control
Mode	VSA
Measurement	<meas>:=VECTor ADEMod

Common Measurement Functions 2

Remote Command	<pre>[:SENSe] : <meas> : SWEEp : POINts <integer> [:SENSe] : <meas> : SWEEp : POINts? [:SENSe] : <meas> : SWEEp : POINts : AUTO OFF ON 0 1 [:SENSe] : <meas> : SWEEp : POINts : AUTO?</pre>
Example	<pre>VECT:SWE:POIN 801 VECT:SWE:POIN? VECT:SWE:POIN:AUTO ON VECT:SWE:POIN:AUTO?</pre>
Notes	<p>Keyboard entry or setting this by SCPI forces state to manual. Any entry other than a valid value is rounded up to the next available value (or limited to the maximum).</p> <p>This key is not shown in measurements other than Vector or Analog Demod.</p>
Couplings	<p>See Res BW Coupling section</p> <p>See Res BW Coupling section</p>
Preset	<pre>801 1</pre>
State Saved	Saved in instrument state.
Range	51 101 201 401 801 1601 3201 6401 12801 25601 51201 102401 204801 409601
Initial S/W Revision	A.01060 or later

Trace/Detector

This key accesses a menu allowing you to select various trace parameters for all VSA based measurements.

Key Path	Front Panel
Mode	VSA, LTE, LTETDD, IDEN
Initial S/W Revision	Prior to A.02.00
Modified at S/W Revision	A.02.00

Select Trace

This softkey brings up a menu that allows you to select the trace that is to receive the action of all successive trace-specific commands like scaling, assignment of trace data, etc. The selected trace is outlined in green and is always made visible. While the Select Trace menu is showing, Each visible trace is annotated in the middle with its own trace number, as shown: below. The trace number annotations disappear when any other menu is showing.

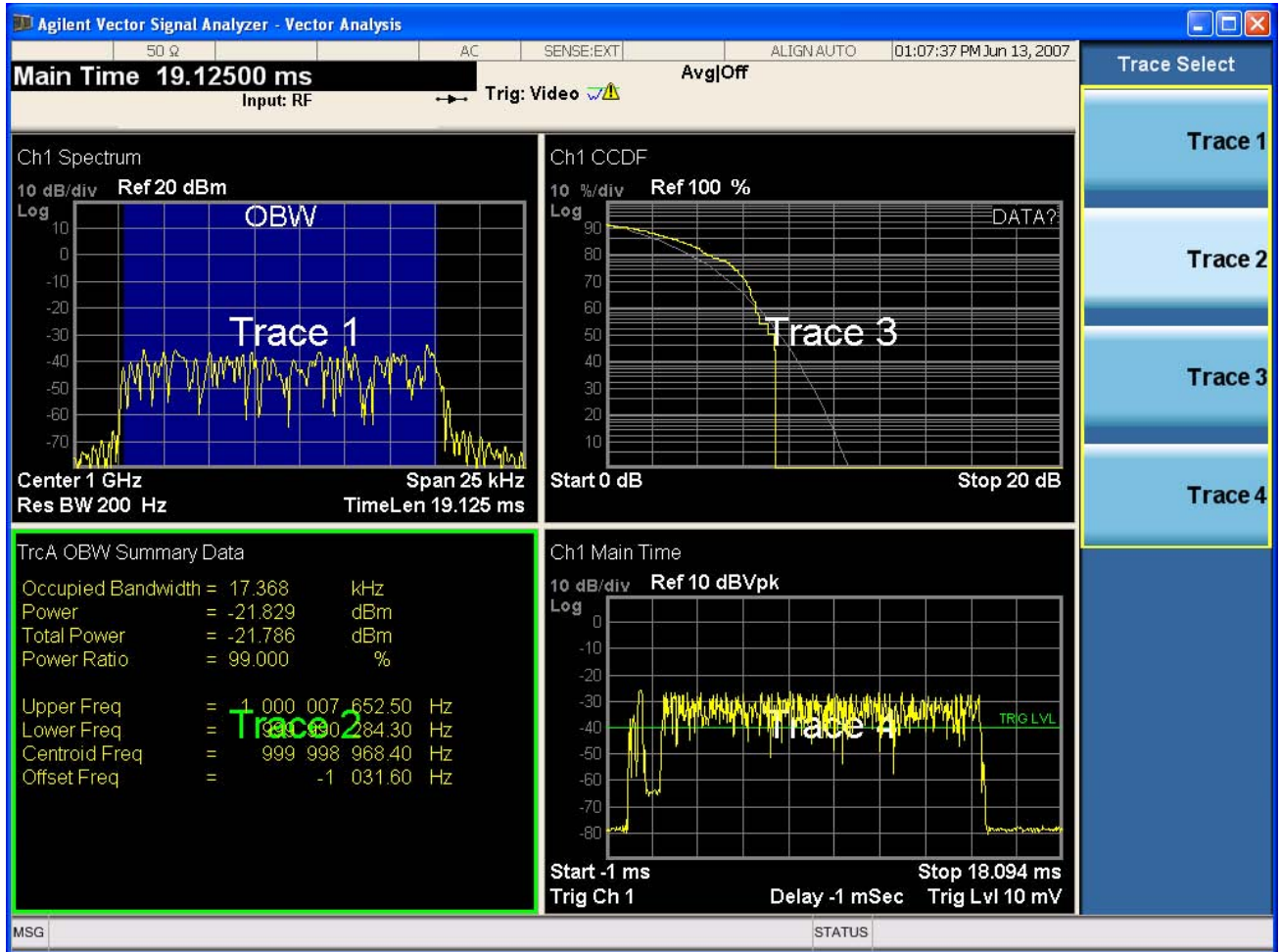

Grid 2x2 layout showing trace annotations when Trace Select dialog is active

This softkey also appears in the X and Y scaling menus. There is only one selected trace at any time. If you change which trace is selected, that change is reflected in this softkey/menu wherever it appears. Other ways to select a trace include use of the Next Window key, clicking within a trace window with a mouse cursor, and issuing a trace-specific SCPI command.

There is no SCPI command associated with this function. Instead, SCPI commands that are trace-specific have an index on the TRACe node that determines the selected trace. Using such a command has the side effect that the trace addressed by the SCPI command becomes the selected trace for any front panel interaction.

Key Path	Trace/Detector (also Span / X Scale or AMPTD ? Y Scale)
Mode	VSA, LTE, LTETDD, IDEN
Notes	No SCPI. Front panel only.
Couplings	Affects any trace-specific commands
Range	Trace 1 Trace 2 Trace 3 Trace 4 Trace 5 Trace 6
Readback Text	Trace <n>

Common Measurement Functions 2

Initial S/W Revision	Prior to A.02.00
Modified at S/W Revision	A.02.00

Data

This accesses a menu of Trace data choices for the selected trace. A VSA Measurement may produce many different results from a single scan; either a graph or a table. In addition, the ACP and OBW functions can be enabled on any trace showing a frequency-domain result, and produce Summary table results. Any of these results may be assigned to a trace and displayed. See the individual measurement PDs for a list of all Trace results that are available for each measurement.

The following Trace Data types are available in all measurements:

Soft Key Name	SCPI string form
No Data	"No Data"
Spectrum	"Spectrum1"
Inst Spectrum	"Inst Spectrum1"
Raw Main Time	"Raw Main Time1"
OBW Summary for Trace 1	"Obw Summary Trc1"
OBW Summary for Trace 2	"Obw Summary Trc2"
OBW Summary for Trace 3	"Obw Summary Trc3"
OBW Summary for Trace 4	"Obw Summary Trc4"
ACP Summary for Trace 1	"Acp Summary Trc1"
ACP Summary for Trace 2	" Acp Summary Trc2"
ACP Summary for Trace 3	" Acp Summary Trc3"
ACP Summary for Trace 4	" Acp Summary Trc4"

The following Data Registers are also available for display if there are traces stored in them (see Trace/Detector, Copy to Data Register and Recall, Data, Trace)

"D1", "D2", "D3", "D4", "D5", and "D6"

Key Path	Trace/Detector, Data
Mode	VSA, LTE, LTETDD, IDEN
Measurement	<meas>:=VECTor ADEMod DDEMod W11A W11B EVM IPOWer IDEMod MOTotalk

Remote Command	:DISPlay:<meas>:TRACe[1] 2 3 4:FEED <string> :DISPlay:<meas>:TRACe[1] 2 3 4:FEED?
Example	DISP:VECT:TRAC1:FEED "Spectrum1" DISP:VECT:TRAC1:FEED?
Preset	Depends on trace number and measurement
State Saved	Saved in instrument state.
Range	see table above and in individual Measurement PDs
Initial S/W Revision	Prior to A.02.00
Modified at S/W Revision	A.02.00

The complete list of Trace Data names that may be assigned using the above SCPI can be obtained by using the following SCPI query:

Mode	VSA, LTE, LTETDD, IDEN
Measurement	<meas>:=VECTor ADEMod DDEMod W11A W11B EVM IPOWER IDEMod MOTotalk
Remote Command	:CALCulate:<meas>:DATA[1] 2 3 4:NAMes?
Example	CALC:VECT:DATA:NAM?
Notes	Query only. Returns a comma-separated list of trace data names that may be used in DISPlay:<meas>:TRACe[1] 2 3 4:FEED "<string>". The list is the same regardless of trace index.
Initial S/W Revision	Prior to A.02.00
Modified at S/W Revision	A.02.00

Spectrum

This key assigns the selected trace to display the Spectrum data result.

The Spectrum trace data displays the spectrum of the selected channel. The spectrum computation displays frequency on the x axis and amplitude on the y axis.

The following formulas show how the analyzer calculates spectrum information:

Common Measurement Functions 2

Key: F = Fast Fourier Transform (FFT)

AF = Averaged spectra

AT = Averaged time

f = Instantaneous spectra

t = Instantaneous time

W = Windowing function

n = Average number

c = Correction trace (from calibration)

$f[n]^2 = f[n] \times \text{conjugate}(f[n])$

$\times = \text{multiplication}$

No Average	$f = F(W \times t) \times c$
rms Average	$AF[n] = \frac{1}{n} \text{sum} (f [n]^2)$
rms Exponential AF[n]Average	$AF[n] = \frac{1}{n} (f [n]^2) + \frac{n-1}{n} AF[n-1]$ where $1 \leq n \leq \text{number of averages}$
Continuous Peak Hold Average	$AF[n] = \text{MAX} (AF[n-1], f [n]^2)$
Time Average	$AF[n] = F\{W \times AT[n]\} \times c$ where $AT[n] = \frac{1}{n} \text{sum} (t [n])$
Time Exponential Average	$AF[n] = F\{W \times AT[n]\} \times c$ where $AT[n] = \frac{1}{n} t [n] + \frac{n-1}{n} AT[n-1]$ and $1 \leq n \leq \text{number of averages}$

As shown in the previous formulas, the spectrum may be a linear spectrum or power spectrum as follows:

If the average is...	then the spectrum is...
Averaging OFF	Linear
rms Average	Power
Continuous peak	Power

Linear spectra contain magnitude and phase (real and imaginary) information. Power spectra contain only magnitude (real) information. This occurs with rms averages, for instance, because the results of the

FFT are squared. Remember that the FFT yields both real and imaginary information. When the analyzer squares the results of the FFT, the imaginary part becomes zero.

See also Trace/Detector, “Data” on page 1730.

Key Path	Trace/Detector, Data
Mode	VSA, LTE, LTETDD, IDEN
Initial S/W Revision	Prior to A.02.00
Modified at S/W Revision	A.02.00

Inst Spectrum

This key assigns the selected trace to display the Inst. Spectrum data result.

Inst Spectrum trace data displays the instantaneous spectrum for the selected input channel. Instantaneous spectrum is computed before data is averaged, which allows you see spectrum data before the data is averaged with other spectrum data.

NOTE Inst Spectrum is not available when analog or digital demodulation is selected.

The following block diagram shows where, in the block diagram, spectrum and instantaneous spectrum are created.

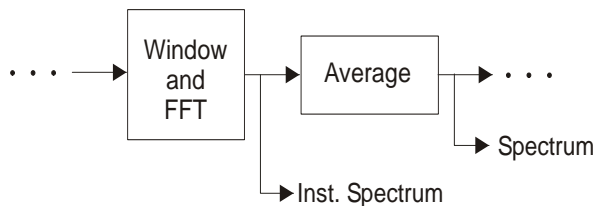

This measurement calculation is useful for these types of averaged measurements:

- rms
- rms exponential
- Continuous peak hold

If averaging is off, the spectrum and instantaneous spectrum display the same information.

See also Trace/Detector, “Data” on page 1730.

Key Path	Trace/Detector, Data
Mode	VSA, LTE, LTETDD, IDEN
Initial S/W Revision	Prior to A.02.00
Modified at S/W Revision	A.02.00

Common Measurement Functions 2

Main Time

This key assigns the selected trace to display the Main Time data result.

Main Time versus Gate Time

The term is used to differentiate between the "main" time record and the "gate" time record when time gating is on.

A time record is the basic building block of the Fast Fourier Transform (FFT). The FFT takes the time-domain information in the time record and transforms it into the frequency domain.

When time gating is on, you can identify a portion of the main time-record to be used by the FFT. The term "main time-record" identifies the entire time record; the term "gate time-record" identifies the portion selected by the gate.

Selecting the Main Time trace data displays the entire time record--the main time-record. Selecting the Gate Time trace data displays that portion of the main time-record marked by the gate--the gate time-record.

The following block diagram shows the blocks that create main time and gate time.

Note that the Analog Demodulation block is available only when analog demodulation is enabled

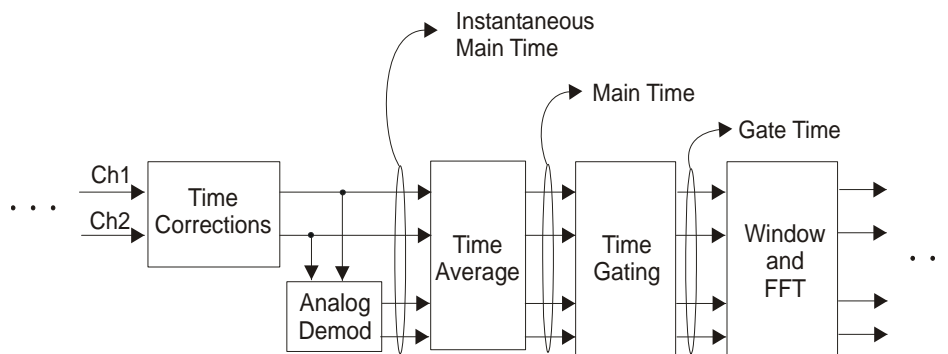

There are many reasons why you may want to view the main time record. Here are just a few:

To verify that there is an input signal.

To see the characteristics of the input signal.

To help in manually setting the input range.

Time Records and Span

If you set the analyzer to full span, the time data you see is the actual input time-record. This is raw input data--the signal from which all subsequent measurements are based.

If you set the instrument to measure a specific bandwidth (something less than full span), the time data you see is the raw input data after it has been filtered (to provide alias protection) and decimated (to obtain the desired span).

Time Records and Averaging

If rms or continuous peak-hold averaging is on, the analyzer displays the most recent time record. The analyzer does not show an averaged time waveform, because all averaging is done after the time data has

been transformed to the frequency domain.

If time averaging is on, the analyzer displays the averaged time-record. In other words, the time record has been averaged with previous time records.

How the Analyzer Displays the Time Record

It is important to remember that although the time record looks like an oscilloscope display, the analyzer is not a digital oscilloscope.

The time record represents samples of a waveform. The samples have enough information to accurately reconstruct the input signal--but the human eye may not properly perform the reconstruction. In fact, for frequencies that are higher than about ten percent of the frequency span, there will be noticeable visible distortion.

The analyzer's anti-alias filters will cause some ringing or distortion of square waves or transients when viewed in the time domain.

See also Trace/Detector, "Data" on page 1730.

Key Path	Trace/Detector, Data
Mode	VSA
Initial S/W Revision	Prior to A.02.00
Modified at S/W Revision	A.02.00

Inst Main Time

This key assigns the selected trace to display the Inst Main Time data result.

Inst Main Time trace data displays the instantaneous time-domain data for the selected input channel.

Note that Inst Main Time is not available when analog or digital demodulation is selected.

The following block diagram shows how Instantaneous Main Time is derived.

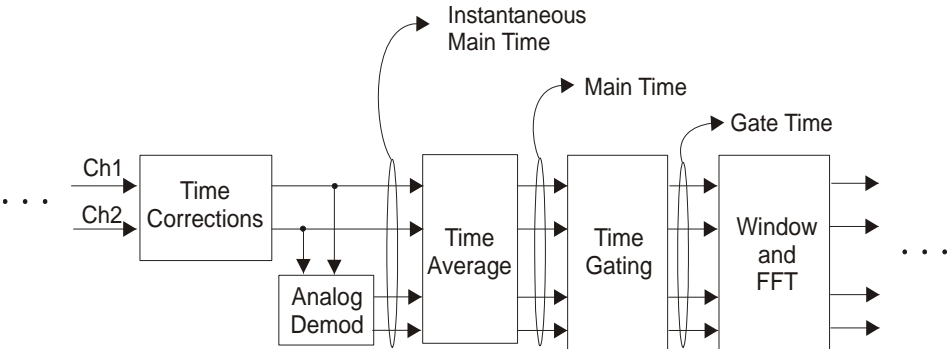

Notice that Instantaneous Main Time shows you time data before time averaging. If time averaging is off, Instantaneous Main Time is identical to Main Time.

See also Trace/Detector, "Data" on page 1730.

Key Path	Trace/Detector, Data
----------	----------------------

Common Measurement Functions 2

Mode	VSA, LTE, LTETDD, IDEN
Initial S/W Revision	Prior to A.02.00
Modified at S/W Revision	A.02.00

Gate Time

This key assigns the selected trace to display the Gate Time data result.

Gate Time trace data displays the selected channel's gate time-record.

Note that Gate Time is not available when analog or digital demodulation is selected.

If time gating is on, Gate Time displays the portion of the main time-record marked by the gate-- this portion is called the gate record (if time gating is off, Gate Time displays nothing).

As a reminder, if time gating is on, the Fast Fourier Transform (FFT) uses the gate time-record, which can be all or a portion of the main time-record, to compute frequency information such as spectrum, frequency response, coherence, and correlation.

See also Trace/Detector, [“Data” on page 1730](#).

Key Path	Trace/Detector, Data
Mode	VSA, LTE, LTETDD, IDEN
Initial S/W Revision	Prior to A.02.00
Modified at S/W Revision	A.02.00

Raw Main Time

This key assigns the selected trace to display the Raw Main Time data result.

Raw Main Time is the raw data read from the input hardware or playback file. It is similar to [“Main Time” on page 1724](#) with the following exceptions:

- This data has not had time corrections applied, so it displays a "CAL?" trace indicator.
- The data has not gone through the analyzer's software resampling filters, so is generally not sampled at the specified sample rate.
- The data has a wider bandwidth than the measurement span would indicate.

Raw Main Time data is useful in the following situations:

- When you use Channel, IF Magnitude, or Magnitude trigger types, the input hardware detects the trigger, so Raw Main Time sometimes gives a better indication of what caused the trigger.
- When you play back a recording, the Raw Main Time measurement data allows you to see exactly the samples that are saved in the recording, with no filtering applied or settling removed.

See also Trace/Detector, [“Data” on page 1730](#).

Key Path	Trace/Detector, Data
----------	----------------------

Mode	VSA, LTE, LTETDD, IDEN
Initial S/W Revision	Prior to A.02.00
Modified at S/W Revision	A.02.00

PSD (Power Spectral Density)

This key assigns the selected trace to display the Power Spectral Density (PSD) data result.

PSD trace data displays the power spectral density (PSD) of the selected channel.

The definition of PSD yields y-axis units of V_{pk}^2/Hz and x-axis units of frequency:

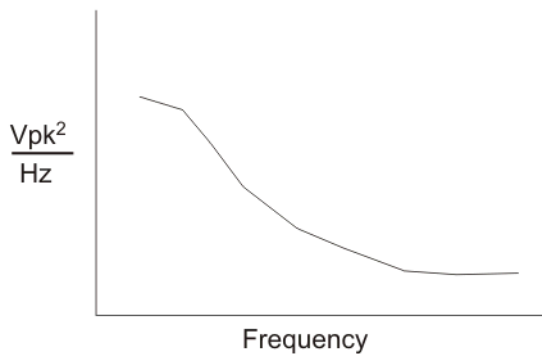

PSD is used for noise measurements. It shows the power density of a signal as a function of frequency. In general, noise may have any arbitrary frequency content, resulting in a variety of possible PSD shapes. Noise that has equal power density at all frequencies is called white noise:

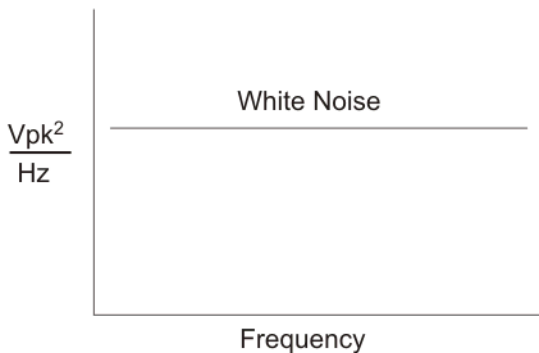

The definition of PSD is power per Hertz. In other words, power is divided by the measurement bandwidth, which in this analyzer is the resolution bandwidth (ResBW), as follows:

$$\frac{V_{pk}^2}{RBW} = \frac{V_{pk}^2}{Hz}$$

Units of V_{pk}^2/Hz assumes the signal is referenced to 1 ohm. That is, because no resistance is specified, the signal is interpreted as a voltage across a one ohm resistor, with the power in the resistor equal to V_{pk}^2 .

Common Measurement Functions 2

You can select units of dBm/Hz to take into account the analyzer's input impedance. PSD defaults to these units. The analyzer calculates dBm/Hz as follows:

$$\frac{\text{dBm}}{\text{Hz}} = 10 \log \left[\frac{\frac{V_{\text{rms}}^2}{Z} \times 1000}{\text{RBW}} \right]$$

where:

RBW = resolution bandwidth (Hz)

Z = input impedance

See also Trace/Detector, “Data” on page 1730.

Key Path	Trace/Detector, Data
Mode	VSA, LTE, LTETDD, IDEN
Initial S/W Revision	Prior to A.02.00
Modified at S/W Revision	A.02.00

Auto Correlation

This key assigns the selected trace to display the autocorrelation data result.

Auto Correlation trace data displays the autocorrelation for the selected input channel. Autocorrelation is a form of correlation, a measure of the similarity between two signals.

Note that Auto Correlation is not available when digital demodulation is selected.

Tips

Use ac coupling only. Correlation measurements are disturbed by dc offsets in the signal.

Some types of averaging may be useful -- rms averaging does not affect correlation measurements, but you can use time averaging to reduce noise, if you can provide a consistent trigger. However, averaging is usually unnecessary to make good correlation measurements.

Use appropriate triggering and trigger delays. This is especially true for time averaging.

Use a random noise source for delay measurements. Correlation measurements provide the ability to resolve time differences between waveforms that appear to be random.

Waveforms on the correlation trace may not appear as they do in the time trace. This is particularly noticeable when you are using correlation to extract synchronous signals from noise. The different shape of some waveforms is a direct result of the mathematical definition of correlation. For example, a correlated square wave appears as a triangle wave. It's important to remember that the period of the waveform is preserved even if the correlation waveform looks different.

To avoid wrap-around effects, correlation produces a time record one-half the length of the measurement time-record.

Theory of Operation

Autocorrelation is a form of correlation, a measure of the similarity between two signals. Correlation is performed by multiplying two signals together at each instant in time and summing all the products. If the signals are identical, every product is positive and the resulting sum is large.

If, however, the two signals are dissimilar, then some of the products are positive and some are negative. In this case, the final sum is smaller because the products tend to cancel.

Autocorrelation performs a time-shifted, "averaged" correlation on a single signal. The signal is correlated with time-shifted versions of itself. Furthermore, the products from each time-shift are averaged by dividing each final sum by the number of products contributing to it.

$$R_{xx}(\tau) = \lim_{T \rightarrow \infty} \frac{1}{T} \int_{\text{conj}} [x(t) \times x(t + \tau)] dt$$

where: R_{xx} = autocorrelation function

τ = amount of time shift

∞ = infinity

$x(\tau)$ = signal to be correlated

intgrl = integration

conj = conjugation

T = time

\times = multiplication

That is, the autocorrelation function is found by taking a signal, multiplying it by the same signal displaced (τ) units in time, and averaging the product over all time.

Duality With the Power Spectrum

For simplicity and speed, this analyzer performs the autocorrelation operation by taking advantage of its duality with the power spectrum:

$$R_{xx}(\tau) \leftrightarrow G_{xx}(f)$$

Thus,

$$\begin{aligned} R_{xx}(\tau) &= I_{\text{FFT}} [G_{xx}(f)] \\ &= I_{\text{FFT}} [\text{conj}(F[r \times t]) \times F(t)] \end{aligned}$$

where: I_{FFT} = Inverse FFT

conj = conjugation

\times = multiplication

r = half size of the rectangular window

(thus the result is $\frac{1}{2}$ the original time length)

When to use Auto Correlation

Auto correlation is useful for detecting echoes in a signal. For random noise, an echo appears as an impulse -- if there is more than one echo, you will see multiple peaks on the auto correlation trace. Keep in mind that an echo appears as an impulse only if the delayed signal has not been filtered. The impulse broadens as the original random noise signal is filtered -- in fact, the width of each peak is inversely

Common Measurement Functions 2

proportional to the bandwidth of the signal.

To determine the time delay (in seconds) of an echo, you can move the marker to the peak of the echo. Note that there is always a correlated peak at zero lag -- this peak marks the original excitation signal. Any other peaks let you know that the excitation signal also appeared at another time relative to the original signal. The amplitude value at the zero lag point is the total power in the time record.

This function is also useful for isolating low-level periodic signals from noise. A sine wave signal shows up as a sine wave in auto correlation. A square wave signal shows up as a triangular wave of the same frequency.

Auto correlation is a single-channel measurement. If you have the original signal on one channel and the delayed version on another, use cross correlation.

Auto Correlation and Averaging

The following formulas show how the analyzer calculates auto correlation for different averaging functions:

Key: F = Fast Fourier Transform (FFT)

AC = Averaged correlation

AT = Averaged time

t = Instantaneous time

c = Instantaneous correlation

r = 1/2 width rectangular window

× = multiplication

n = Average number

No Average $c = I (\text{conj} (F(r \times t)) \times F [t])$

rms Average $c = I (\text{conj} (F(r \times t)) \times F [t])$

rms Expon. $c = I (\text{conj} (F(r \times t)) \times F [t])$

Average

Continuous

Peak Hold $c = I (\text{conj} (F(r \times t)) \times F [t])$

Average

Time AC [n] = $I (\text{conj} (F(r \times AT [n])) \times F (AT [n]))$

Average

where: $AT [n] = \frac{1}{n} \text{sum} (t [n])$

Time

Expon. AC[n] = $I (\text{conj} (F(r \times AT [n])) \times F (AT [n]))$

Average

where: $AT [n] = \frac{1}{n} t [n] + \frac{n-1}{n} AT [n-1]$

and: $1 < n < \text{number of averages}$

See also Trace/Detector, “Data” on page 1730.

Key Path	Trace/Detector, Data
Mode	VSA
Initial S/W Revision	Prior to A.02.00

Statistical

This key accesses the Trace Data choices which show the statistical results: CCDF, CDF and PDF.

Key Path	Trace/Detector, Data
Mode	VSA

CCDF (Complementary, Cumulative Density Function)

This key assigns the selected trace to display the CCDF data result.

CCDF trace data displays the complementary, cumulative density function (CCDF) for the selected input channel.

The complementary, cumulative density function (CCDF) is a statistical-power calculation and can be performed only on time-domain data. As its name suggests, CCDF is the complement of CDF, and is defined as follows:

$\text{CDF}(K) = \text{Probability}(x \leq K)$ $\text{CCDF}(K) = \text{Probability}(x \geq K)$
--

CCDF provides better resolution than CDF for low probability signals, especially when log format is used for the y-axis.

The analyzer plots CCDF using units of percent (%) for the y-axis and power (dB) for the x-axis. Power on the x-axis is relative to the signal average power, so 0 dB is the average power of the signal. Therefore, a marker readout of

Trace A Marker 2 dB 12 %

means there is a 12% probability that the signal power will be 2 dB or more above the average power.

CCDF Calculation:

Calculate the RMS value for all measured samples; this becomes the 0 dB point at the left end of the x-axis.

Normalize all samples to the RMS value in units of dB.

Determine which x-axis bin each sample belongs in between 0 and 20 dB.

Calculate the total number of samples that are greater than or equal to each x-axis bin and plot as a percent of the number of samples measured.

Samples Used in the Power Measurement

For the Demod Off and Analog demod modes, the analyzer computes CCDF using all samples in the current time record (all points in the active trace). Each successive time record adds additional samples to the CCDF measurement.

Common Measurement Functions 2

For WLAN - OFDM and -DSSS demod modes, the analyzer computes CCDF using all samples specified within the measurement interval.

Restarting the Power Measurement

Selecting CCDF, restarting the measurement, or changing most measurement parameters restarts the CCDF measurement. For example, changing the range or center frequency resets the number of samples used in the CCDF measurement to zero and restarts the CCDF measurement.

Tips

Note the following when making CCDF measurements:

For best results, set the analyzer's displayed frequency span to include all the energy of your signal. In other words, make sure the displayed frequency span includes the entire bandwidth of the measured signal.

The CCDF measurement does not restart:

After a calibration

After you continue a paused measurement

Many channel specific changes restart the CCDF measurement on both channels, such as changing the gate delay, or input coupling.

The analyzer displays DATA? if the average power drifts 8 to 10 dB from the average power measured in the first time record. For example, the analyzer would display DATA? if you measured a transmitter signal that was off when the CCDF measurement started but then turned on later in the measurement.

CCDF measurements are disabled during time averaging.

See also Trace/Detector, “Data” on page 1730.

Key Path	Trace/Detector, Data
Mode	VSA, LTE, LTETDD, IDEN
Initial S/W Revision	Prior to A.02.00
Modified at S/W Revision	A.02.00

CDF (Cumulative Density Function)

This key assigns the selected trace to display the CDF data result.

CDF trace data displays the Cumulative Density Function (CDF) for the selected input channel. CDF is computed by integrating the PDF (Probability Density Function). CDF is explained in online help for the CCDF trace data for further details, see that topic.

See also Trace/Detector, “Data” on page 1730.

Key Path	Trace/Detector, Data
Mode	VSA, LTE, LTETDD, IDEN
Initial S/W Revision	Prior to A.02.00
Modified at S/W Revision	A.02.00

PDF (Probability Density Function)

This key assigns the selected trace to display the PDF data result.

PDF trace data displays the Probability Density Function of the selected channel. PDF indicates the probability that a given level has occurred.

PDF is equivalent to a normalized histogram. A histogram shows how the amplitude of a signal is distributed between its maximum and minimum values. Amplitude is displayed on the X-axis, and number of counts on the Y-axis.

The number of averages for a histogram determines the number of counts in the histogram; in other words, how many records are measured. If the records are not "averaged". If averaging is off or if exponential averaging is selected, the measurement continues indefinitely. Keep in mind that the accuracy of the histogram is dependent on the frequency span, time-record length, and number of averages (if averaging is on).

Histograms are used for such things as determining the statistical properties of noise and monitoring the performance of electromechanical positioning systems.

PDF trace data is normalized by multiplying the number of averages by the number of points in the time record, then dividing this value by the DV spacing on the X-axis. The probability of a signal falling between two points is equal to the integral of the curve between those points.

PDF trace data displays the number of points used in its computation above the trace (Pts:). It also displays the average level (Avg:) above the trace.

See also Trace/Detector, ["Data" on page 1730](#).

Key Path	Trace/Detector, Data
Mode	VSA, LTE, LTETDD, IDEN
Initial S/W Revision	Prior to A.02.00
Modified at S/W Revision	A.02.00

ACP (Adjacent Channel Power)

This key provides access to ACP summary table data. These results are available when the ACP function is enabled for particular trace, and allow you to display the results in another trace.

Key Path	Trace/Detector, Data
Mode	VSA, LTE, LTETDD, IDEN
Initial S/W Revision	Prior to A.02.00
Modified at S/W Revision	A.02.00

ACP Summary for Trace 1

This key assigns the selected trace to display trace to display results for ACP function on Trace 1.

See also ["ACP Setup" on page 1757](#)

Key Path	Trace/Detector, Data, ACP
Mode	VSA, LTE, LTETDD, IDEN

Common Measurement Functions 2

Initial S/W Revision	Prior to A.02.00
Modified at S/W Revision	A.02.00

ACP Summary for Trace 2

This key assigns the selected trace to display trace to display results for the ACP function on Trace 2.

See also [“ACP Setup” on page 1757](#)

Key Path	Trace/Detector, Data, ACP
Mode	VSA, LTE, LTETDD, IDEN
Initial S/W Revision	Prior to A.02.00
Modified at S/W Revision	A.02.00

ACP Summary for Trace 3

This key assigns the selected trace to display trace to display results for the ACP function on Trace 3.

See also [“ACP Setup” on page 1757](#)

Key Path	Trace/Detector, Data, ACP
Mode	VSA, LTE, LTETDD, IDEN
Initial S/W Revision	Prior to A.02.00
Modified at S/W Revision	A.02.00

ACP Summary for Trace 4

This key assigns the selected trace to display trace to display results for the ACP function on Trace 4.

See also [“ACP Setup” on page 1757](#)

Key Path	Trace/Detector, Data, ACP
Mode	VSA, LTE, LTETDD, IDEN
Initial S/W Revision	Prior to A.02.00
Modified at S/W Revision	A.02.00

ACP Summary for Trace 5

This key assigns the selected trace to display trace to display results for the ACP function on Trace 5.

See also [“ACP Setup” on page 1757](#).

Key Path	Trace/Detector, Data, ACP
Mode	VSA

ACP Summary for Trace 6

This key assigns the selected trace to display trace to display results for the ACP function on Trace 6.

See also [“ACP Setup” on page 1757](#)

Key Path	Trace/Detector, Data, ACP
Mode	VSA

OBW (Occupied Bandwidth)

This key provides access to OBW summary table data. These results are available if the OBW function is enabled for particular trace, and allow you to display the results in another trace.

Key Path	Trace/Detector, Data
Mode	VSA, LTE, LTETDD, IDEN
Initial S/W Revision	Prior to A.02.00
Modified at S/W Revision	A.02.00

OBW Summary for Trace 1

This key assigns the selected trace to display trace to display results for the OBW function on Trace 1.

See also: [“OBW Setup \(Occupied Bandwidth\)” on page 1765](#)

Key Path	Trace/Detector, Data, OBW
Mode	VSA, LTE, LTETDD, IDEN
Initial S/W Revision	Prior to A.02.00
Modified at S/W Revision	A.02.00

OBW Summary for Trace 2

This key assigns the selected trace to display trace to display results for the OBW function on Trace 2.

See also: [“OBW Setup \(Occupied Bandwidth\)” on page 1765](#).

Key Path	Trace/Detector, Data, OBW
Mode	VSA, LTE, LTETDD, IDEN
Initial S/W Revision	Prior to A.02.00
Modified at S/W Revision	A.02.00

OBW Summary for Trace 3

This key assigns the selected trace to display trace to display results for the OBW function on Trace 3.

Common Measurement Functions 2

See also: [“OBW Setup \(Occupied Bandwidth\)” on page 1765.](#)

Key Path	Trace/Detector, Data, OBW
Mode	VSA, LTE, LTETDD, IDEN
Initial S/W Revision	Prior to A.02.00
Modified at S/W Revision	A.02.00

OBW Summary for Trace 4

This key assigns the selected trace to display trace to display results for the OBW function on Trace 4.

See also: [“OBW Setup \(Occupied Bandwidth\)” on page 1765.](#)

Key Path	Trace/Detector, Data, OBW
Mode	VSA, LTE, LTETDD, IDEN
Initial S/W Revision	Prior to A.02.00
Modified at S/W Revision	A.02.00

OBW Summary for Trace 5

This key assigns the selected trace to display trace to display results for the OBW function on Trace 5.

See also: [“OBW Setup \(Occupied Bandwidth\)” on page 1765.](#)

Key Path	Trace/Detector, Data, OBW
Mode	VSA

OBW Summary for Trace 6

This key assigns the selected trace to display trace to display results for the OBW function on Trace 6.

See also: [“OBW Setup \(Occupied Bandwidth\)” on page 1765.](#)

Key Path	Trace/Detector, Data, OBW
Mode	VSA

No Data

This key allows you to turn off trace computations. Measurement results are not computed unless assigned to a trace. No Data lets you increase measurement speed by turning off post-processing calculations that are not needed.

Key Path	Trace/Detector, Data
Mode	VSA, LTE, LTETDD, IDEN
Initial S/W Revision	Prior to A.02.00

Modified at S/W Revision	A.02.00
--------------------------	---------

Format

This accesses a menu that allows you to choose the format of the selected trace. Any format may be assigned to any trace. For symbol tables and tabular data the format choice is ignored. If the data doesn't have defined symbol times, Constellation format is the same as I-Q, Eye formats are the same as Real or Imaginary, and Trellis format is the same as Unwrapped Phase.

The formats are:

Format name	Description
Log Mag (dB)	Data is converted to decibel units and shown on a linear Y axis
Linear Mag (Abs Value)	Magnitude of the data is shown on a linear Y axis
Real (I)	Real part of data is shown on a linear Y axis
Imaginary (Q)	Imaginary part of data is shown on linear Y axis
I-Q	Real part of data is shown on horizontal axis, imaginary part is shown on vertical axis, Independent variable (X axis) is normal to display
Constellation	Same as I-Q, but for data with symbols defined, only the symbol points are shown as dots with no connecting lines.
Wrap Phase	Phase of complex data, limited to ± 180 deg, is shown on Y axis
Unwrap Phase	Phase of complex data is shown "unwrapped", that is, without discontinuities. Not limited to ± 180 degrees.
I-Eye	Real part of data is shown with X axis segmented (generally into 2 symbol segments) and each segment is overlaid to show signal crossings at symbol boundaries
Q-Eye	Same as I-eye but imaginary part of data is shown
Trellis	Same as I-eye but uses unwrapped phase of data
Group Delay	Useful for frequency response displays. Shows the derivative of phase response with respect to frequency.
Log Mag (Linear Unit)	Displays data with a logarithmic Y axis, but marker read outs are in linear magnitude units.

Key Path	Trace/Detector, Format
Mode	VSA, LTE, LTETDD, IDEN
Measurement	<meas>:=VECTor ADEMod DDEMod W11A W11B EVM IPOWER IDEMod MOTotalk

Common Measurement Functions 2

Remote Command	:DISPlay:<meas>:TRACe[1] 2 3 4:FORMat MLOG MLINear REAL IMAGinary VECTor CONS PHASe UPHase IE YE QEYE TRELlis GDElay MLGLinear :DISPlay:<meas>:TRACe[1] 2 3 4:FORMat?
Example	DISP:DDEM:TRAC2:FORM MLIN DISP:DDEM:TRAC2:FORM?
Preset	Depends on trace and measurement
State Saved	Saved in instrument state.
Range	Log Mag (dB) Linear Mag (Abs Value) Real (I) (Lin) Imaginary (Q) (Lin) I-Q Constellation Wrap Phase Unwrap Phase I-Eye Q-Eye Trellis-Eye Group Delay Log Mag (Linear Unit)
Readback Text	Log Mag (dB) Linear Mag Real (I) Imaginary (Q) I-Q Constellation Wrap Phase Unwrap Phase I-Eye Q-Eye Trellis-Eye Group Delay Log Mag
Initial S/W Revision	Prior to A.02.00
Modified at S/W Revision	A.02.00

Digital Demod Trace Setup

This key accesses a menu of settings that control certain elements of displays of digitally demodulated trace data.

Key Path	Trace/Detector
Mode	VSA, LTE, LTETDD, IDEN
Initial S/W Revision	Prior to A.02.00
Modified at S/W Revision	A.02.00

Symbol Shape

For all time-domain displays except IQ diagrams, Symbol Shape lets you display dots, bars, or nothing (none) at symbol locations (if the trace contains demodulated time-domain data). This key allows you to select the symbol shape for the selected trace.

If you select bars, vertical lines (bars) are drawn from the baseline to the symbol location on the trace. The baseline is 0 for all traces that have coordinates other than log (dB). The baseline is the bottom of the trace box for traces that have log (dB) coordinates.

With IQ diagrams, displaying vertical bars is meaningless. Therefore, selecting bars displays dots in IQ diagrams.

With constellation diagrams, selecting none is the same as selecting bars--you cannot turn off the dots in a constellation diagram.

Key Path	Trace/Detector, Digital Demod Trace Setup
Mode	VSA, LTE, LTETDD, IDEN

Measurement	<meas>:=VECTor ADEMod DDEMod W11A W11B EVM IPOWER IDEMod MOTotalk
Remote Command	:DISPlay:<meas>:TRACe[1] 2 3 4:DDEMod:SYMBol BARS DOTS OFF :DISPlay:<meas>:TRACe[1] 2 3 4:DDEMod:SYMBol?
Example	DISP:DDEM:TRAC2:DDEM:SYMB DOTS DISP:DDEM:TRAC2:DDEM:SYMB?
Preset	BARS
State Saved	Saved in instrument state.
Range	Bars Dots None
Initial S/W Revision	Prior to A.02.00
Modified at S/W Revision	A.02.00

Ideal State Shape

Digital Demodulation shows you the location of all ideal symbol states in an I-Q or constellation diagram. This key lets you choose between a cross, circle, or none to represent the ideal state on the selected trace.

Key Path	Trace/Detector, Digital Demod Trace Setup
Mode	VSA, LTE, LTETDD, IDEN
Measurement	<meas>:=VECTor ADEMod DDEMod W11A W11B EVM IPOWER IDEMod MOTotalk
Remote Command	:DISPlay:<meas>:TRACe[1] 2 3 4:DDEMod:SYMBol:SHAPE CIRClE CROSS OFF :DISPlay:<meas>:TRACe[1] 2 3 4:DDEMod:SYMBol:SHAPE?
Example	DISP:DDEM:TRAC2:DDEM:SYMB:SHAP CIRC DISP:DDEM:TRAC2:DDEM:SYMB:SHAP?
Preset	CIRC
State Saved	Saved in instrument state.
Range	Circle Cross None
Initial S/W Revision	Prior to A.02.00
Modified at S/W Revision	A.02.00

Ideal State Size

Determines the ideal state size, as a percentage of the maximum ideal state distance from the origin (the same way Error Vector Magnitude is defined). Ideal states are shown as circles or crosses in Vector and constellation diagrams, as determined by the Ideal State Shape setting.

Common Measurement Functions 2

The ideal state is where symbols occur if your signal is without error. Showing the ideal states gives a visual indication of the quality of your signal.

You can use this feature to determine if symbols have an EVM above a specified Value. For example, to see if any symbols have an EVM greater than 10%, set the state size to 10% and select Circle as the shape. Any symbols that fall outside of the circle (other than SYNC or PILOT symbols) have an EVM greater than 10%.

Key Path	Trace/Detector, Digital Demod Trace Setup
Mode	VSA, LTE, LTETDD, IDEN
Measurement	<meas>:=VECTor ADEMod DDEMod W11A W11B EVM IPOWer IDEMod MOTotalk
Remote Command	:DISPlay:<meas>:TRACe[1] 2 3 4 :DDEMod:SYMBol:SIZE <real> :DISPlay:<meas>:TRACe[1] 2 3 4 :DDEMod:SYMBol:SIZE?
Example	DISP:DDEM:TRAC2:DDEM:SYMB:SIZE 10 DISP:DDEM:TRAC2:DDEM:SYMB:SIZE?
Notes	Parameter is interpreted as a percent, e.g., if you want the ideal size to be 10% send 10, not 0.1
Preset	5
State Saved	Saved in instrument state.
Min	0.1
Max	50
Initial S/W Revision	Prior to A.02.00
Modified at S/W Revision	A.02.00

Symbol Table Format

This allows you to choose the format in which symbol table data is displayed, when the modulation format encodes 4 or more bits per symbol. You may choose binary or hexadecimal. Binary symbol data is padded with leading zeros to make a multiple of 4 bits before conversion to hexadecimal. For example, for 16 QAM format, each 4-bit symbol will be displayed as 2 hex digits.

Binary Format: The symbol data bit format is binary and each character represents a binary digit. The number to the left of each row indicates the bit offset of the first bit in the row.

Hexadecimal Format: The symbol data bit format is hexadecimal and each character represents a hexadecimal digit. The number to the left of each row indicate the symbol offset of the first symbol in the row.

NOTE There must be at least 4 bits/symbol to use the hexadecimal format, that is, symbols that have less than 4 bits/symbol will only be displayed in binary format regardless of the Symbol Table Format setting.

This parameter is valid only when:

- The active trace is a symbol table, and
- The current demodulation format supports hexadecimal, the demodulation format's bits/symbol is equal to or greater than four.

Key Path	Trace/Detector, Digital Demod Trace Setup
Mode	VSA, LTE, LTETDD, IDEN
Measurement	<meas>:=VECTor ADEMod DDEMod W11A W11B EVM IPOWER IDEMod MOTotalk
Remote Command	:DISPlay:<meas>:TRACe[1] 2 3 4:DDEMod:SYMBol:FORMat HEXadecimal BINary :DISPlay:<meas>:TRACe[1] 2 3 4:DDEMod:SYMBol:FORMat?
Example	DISP:DDEM:TRAC2:DDEM:SYMB:FORM BIN DISP:DDEM:TRAC2:DDEM:SYMB:FORM?
Preset	HEX
Range	Hex Binary
Initial S/W Revision	Prior to A.02.00
Modified at S/W Revision	A.02.00

Eye Length

This property controls how wide (in symbol periods) the eye and trellis diagrams are, for the selected trace.

Key Path	Trace/Detector, Digital Demod Trace Setup
Mode	VSA, LTE, LTETDD, IDEN
Measurement	<meas>:=VECTor ADEMod DDEMod W11A W11B EVM IPOWER IDEMod MOTotalk
Remote Command	:DISPlay:<meas>:TRACe[1] 2 3 4:DDEMod:EYE:COUNT <real> :DISPlay:<meas>:TRACe[1] 2 3 4:DDEMod:EYE:COUNT?
Example	DISP:DDEM:TRAC2:DDEM:EYE:COUN 3 DISP:DDEM:TRAC2:DDEM:EYE:COUN?
Preset	2
State Saved	Saved in instrument state.
Min	0.1
Max	40
Initial S/W Revision	Prior to A.02.00

Common Measurement Functions 2

Modified at S/W Revision	A.02.00
--------------------------	---------

Time Unit

This property lets you select the time units that are applied to x-axis annotations and marker readouts for the selected trace, whenever it is assigned data with (demodulation) symbol information. The available measurement units are sym (symbols) or sec (seconds).

Key Path	Trace/Detector, Digital Demod Trace Setup
Mode	VSA, LTE, LTETDD, IDEN
Measurement	<meas>:=VECTor ADEMod DDEMod W11A W11B EVM IPOWer IDEMod MOTotalk
Remote Command	:DISPlay:<meas>:TRACe[1] 2 3 4 :DDEMod:UNIT:TIME SEC SYMBol :DISPlay:<meas>:TRACe[1] 2 3 4 :DDEMod:UNIT:TIME?
Example	DISP:VECT:TRAC2:DDEM:UNIT:TIME SYMB DISP:VECT:TRAC2:DDEM:UNIT:TIME?
Preset	SYMB
State Saved	Saved in instrument state.
Range	sym sec
Initial S/W Revision	Prior to A.02.00
Modified at S/W Revision	A.02.00

Freq Unit

This property lets you select the frequency units that are applied to x-axis annotations and marker readouts for the selected trace, whenever it is assigned data with (demodulation) carrier information. The available measurement units are carrier or Hz.

Key Path	Trace/Detector, Digital Demod Trace Setup
Mode	VSA, LTE, LTETDD, IDEN
Measurement	<meas>:=VECTor ADEMod DDEMod W11A W11B EVM IPOWer IDEMod MOTotalk
Remote Command	:DISPlay:<meas>:TRACe[1] 2 3 4 :DDEMod:UNIT:FREQuency CARRier HZ :DISPlay:<meas>:TRACe[1] 2 3 4 :DDEMod:UNIT:FREQuency?
Example	DISP:VECT:TRAC2:DDEM:UNIT:FREQ CARR DISP:VECT:TRAC2:DDEM:UNIT:FREQ?
Preset	CARR

State Saved	Saved in instrument state.
Range	carrier Hz
Initial S/W Revision	Prior to A.02.00
Modified at S/W Revision	A.02.00

Avg Line

This controls whether or not the average line is visible on certain demodulation analysis traces such as Error Vector Time and Error Vector Spectrum in OFDM related modulation analysis measurements. These traces have 2-dimensional domains; typically subcarriers (frequency) and symbol times. Since the result can only be shown with one of these dimensions on the x-axis, the other dimension is placed on the z-axis. Since all the z-axis values are overlapped, an average is calculated for all z values at each x value and the average is normally displayed as a line in front of trace. The average line display can be turned on or off using this control.

Key Path	Trace/Detector, Digital Demod Trace Setup
Mode	VSA, LTE, LTETDD, IDEN
Measurement	<meas>:=VECTor ADEMod DDEMod W11A W11B EVM IPOWer IDEMod MOTotalk
Remote Command	:DISPlay:<meas>:TRACe[1] 2 3 4:DDEMod:ALINe OFF ON 0 1 :DISPlay:<meas>:TRACe[1] 2 3 4:DDEMod:ALIN?
Example	DISP:W11A:TRAC:DDEM:ALIN OFF
Preset	1
State Saved	Saved in instrument state.
Initial S/W Revision	A.03.00 or later

Copy to Data Register

This key accesses a menu of immediate execute keys, each of which copies the selected trace to a particular data register. Data registers can be displayed in any trace. They are measurement global, so you can copy data to a register while in the Digital Demod measurement and view it later while in the Vector measurement. Data registers are cleared when the VSA Application is exited and reentered, but not when you change Modes and return.

Key Path	Trace/Detector
Mode	VSA, LTE, LTETDD, IDEN
Measurement	<meas>:=VECTor ADEMod DDEMod W11A W11B EVM IPOWer IDEMod MOTotalk
Remote Command	:DISPlay:<meas>:TRACe[1] 2 3 4:COpy D1 D2 D3 D4 D5 D6
Example	DISP:VECT:TRAC:COpy D1

Common Measurement Functions 2

Readback Text	Last: <date_time> Empty
Initial S/W Revision	Prior to A.02.00
Modified at S/W Revision	A.02.00

The following SCPI provides means to determine if a Data Register is empty, and to erase the data from any or all Data Registers.

Key Path	SCPI only
Mode	VSA, LTE, LTETDD, IDEN
Remote Command	:CALCulate:DATA:REGister[1] 2 3 4 5 6:EMPTY?
Example	:CALC:DATA:REG2:EMPT?
Notes	Query only: returns 1 if a Data Register has no trace data assigned to it.
Initial S/W Revision	Prior to A.02.00
Modified at S/W Revision	A.02.00

Key Path	SCPI only
Mode	VSA, LTE, LTETDD, IDEN
Remote Command	:CALCulate:DATA:REGister[1] 2 3 4 5 6:REMOve
Example	:CALC:DATA:REG2:REM
Notes	Removes trace data assigned to specified Data Register.
Couplings	If Data Register is assigned to a trace, the trace data is changed to No Data
Initial S/W Revision	Prior to A.02.00
Modified at S/W Revision	A.02.00

Key Path	SCPI only
Mode	VSA, LTE, LTETDD, IDEN
Remote Command	:CALCulate:DATA:REGister:ALL:REMOve
Example	:CALC:DATA:REG:ALL:REM
Notes	Removes trace data assigned to all Data Registers.
Couplings	If Data Register is assigned to a trace, the trace data is changed to No Data
Initial S/W Revision	Prior to A.02.00
Modified at S/W Revision	A.02.00

Phase/Delay Properties

This key accesses a menu of properties that affect the selected trace when displayed using phase or delay

formats

Key Path	Trace/Detector
Mode	VSA, LTE, LTETDD, IDEN
Initial S/W Revision	Prior to A.02.00
Modified at S/W Revision	A.02.00

Phase/Trellis Offset

This is only used if the trace Format is Wrap Phase, Unwrap Phase or Trellis. For Unwrap Phase or Trellis displays, the phase offset value is added to the existing phase at each point. For example, If you are viewing an Unwrapped Phase trace, setting the Phase/Trellis Offset to 5 degrees moves the entire trace up 5 degrees (and changes the value displayed by a marker by the same amount). For Wrap Phase displays the phase offset only affects the phase wrap point, not the underlying data. The point at which the phase wraps is 180 degrees plus the phase offset. For example, suppose you have a marker on a Wrap Phase display whose phase offset is 0 and the marker is showing -3 degrees. The trace data will all be confined within $(-180, 180]$ degrees. If you then change the phase offset to 180 degrees, then the Wrap Phase display will show values within the interval $(0, 360]$ degrees and the marker value will be displayed as 357 degrees, which is the wrapped equivalent of -3 degrees.

Key Path	Trace/Detector, Phase Delay Properties
Mode	VSA, LTE, LTETDD, IDEN
Measurement	<meas>:=VECTor ADEMod DDEMod W11A W11B EVM IPOWER IDEMod MOTotalk
Remote Command	:DISPlay:<meas>:TRACe[1] 2 3 4:FORMat:PHASe:OFFSet <real> :DISPlay:<meas>:TRACe[1] 2 3 4:FORMat:PHASe:OFFSet?
Example	DISP:DDEM:TRAC3:FORM:PHAS:OFFS 31 DISP:DDEM:TRAC3:FORM:PHAS:OFFS?
Preset	0
State Saved	Saved in instrument state.
Min	$-1E+8$
Max	$1E+8$
Initial S/W Revision	Prior to A.02.00
Modified at S/W Revision	A.02.00

Unwrap Phase Ref

Unwrapped phase lets you designate the point (x-axis) value about which phase values are to be unwrapped. That is, the phase at the designated reference will be within -180 to 180 degrees, and phase

Common Measurement Functions 2

will vary smoothly without jumps around that point.

Key Path	Trace/Detector, Phase Delay Properties
Mode	VSA, LTE, LTETDD, IDEN
Measurement	<meas>:=VECTor ADEMod DDEMod W11A W11B EVM IPOWer IDEMod MOTotalk
Remote Command	:DISPlay:<meas>:TRACe[1] 2 3 4 :FORMat : PHASe : UNWRap : REFerence <real> :DISPlay:<meas>:TRACe[1] 2 3 4 :FORMat : PHASe : UNWRap : REFerence?
Example	DISP:DDEM:TRAC3:FORM:PHAS:UNWR:REF 24.5E6 DISP:DDEM:TRAC3:FORM:PHAS:UNWR:REF?
Preset	0
State Saved	Saved in instrument state.
Min	-9.9e37
Max	9.9e37
Initial S/W Revision	Prior to A.02.00
Modified at S/W Revision	A.02.00

Group Delay Aperture

The value of Delay Aperture is used when the trace format is Group Delay. The aperture is specified as a percentage of the current frequency span for frequency-domain data. It is specified as a percentage of the time-record length for time-domain data.

When group delay is calculated for a given point (which can be a time- or frequency-domain point), the aperture is centered at that point. Larger apertures decrease resolution, but they increase the smoothing of the group-delay trace.

The point plotted for group delay is located between the data points used to calculate it. For example, in the frequency domain, the group delay for 100 Hz may be calculated by measuring the change in phase between 90 and 110 Hz. If you had specified a start frequency of 90 Hz, 100 Hz would be the first point with group delay data. This results in a trace that does not extend to the edges of the screen (more noticeable as the delay aperture increases).

Note that the smallest aperture that you can select depends on the number of frequency points. If you select an invalid aperture, the analyzer automatically selects the smallest valid aperture.

Key Path	Trace/Detector, Phase Delay Properties
Mode	VSA, LTE, LTETDD, IDEN
Measurement	<meas>:=VECTor ADEMod DDEMod W11A W11B EVM IPOWer IDEMod MOTotalk

Remote Command	:DISPlay:<meas>:TRACe[1] 2 3 4:FORMat:DELay:APERture <real> :DISPlay:<meas>:TRACe[1] 2 3 4:FORMat:DELay:APERture?
Example	DISP:DDEM:TRAC3:FORM:DEL:APER 1 DISP:DDEM:TRAC3:FORM:DEL:APER?
Notes	Parameter is interpreted as a percent, e.g., if you want the group delay aperture to be 1% send 1, not 0.01
Preset	0.5
State Saved	Saved in instrument state.
Min	0.00390625
Max	16
Initial S/W Revision	Prior to A.02.00
Modified at S/W Revision	A.02.00

ACP Setup

The adjacent channel power (ACP) function calculates the power in a reference band of frequencies as well as bands of frequencies offset from the reference, and calculates the ratio of each offset band to the reference band power.

The ACP key accesses a menu of functions that allow you to define and turn on the ACP function on the selected trace. One reference channel and up to 5 offset frequencies may be defined, and ACP will be calculated for bands both above and below the reference frequency for each offset.

An ACP measurement may be defined for each trace, although it will only be active on frequency-domain trace data. The reference and offset frequency bands defined by the ACP measurement are shown as gold bars overlaying the trace display. To see tabular data showing power and power ratio results, you may assign the ACP Summary (Trace n) to a different trace. For example, you can assign Spectrum data to trace 1, turn on and define an ACP measurement on trace 1, assign the ACP Summary (Trace 1) to trace 2, and use a 2x2 display to view both at the same time, as shown below

Common Measurement Functions 2

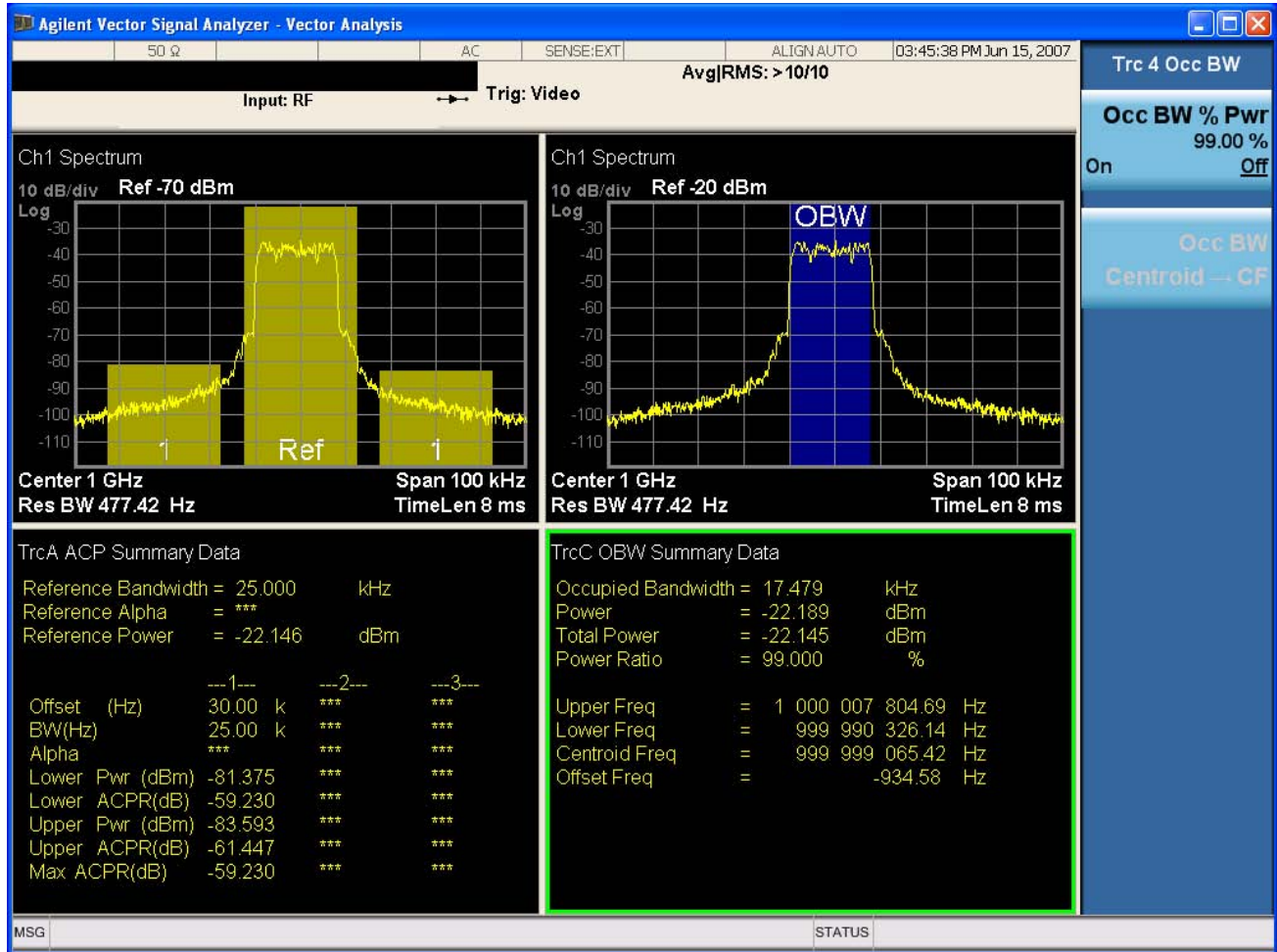

The summary data may be retrieved programmatically using `FETCh?` or the `CALCulate:<meas>:DATA:TABLE` commands. See the Data Queries section under Common Functions for more details.

Key Path	Trace/Detector
Mode	VSA, LTE, LTETDD, IDEN
Readback Text	[On Off,]
Initial S/W Revision	Prior to A.02.00
Modified at S/W Revision	A.02.00

ACP On/Off

This softkey turns the ACP function on or off for the selected trace

Key Path	Trace/Detector, ACP
Mode	VSA, LTE, LTETDD, IDEN

Measurement	<meas>:=VECTor ADEMod DDEMod W11A W11B EVM IPOWer IDEMod MOTotalk
Remote Command	:CALCulate:<meas>:TRACe[1] 2 3 4:ACPoweR:STATe OFF ON 0 1 :CALCulate:<meas>:TRACe[1] 2 3 4:ACPoweR:STATe?
Example	CALC:VECT:TRAC1:ACP:STATE ON CALC:VECT:TRAC1:ACP:STATE?
Preset	0
State Saved	Saved in instrument state.
Initial S/W Revision	Prior to A.02.00
Modified at S/W Revision	A.02.00

Carrier Freq

This key allows you to enter the carrier frequency of the reference channel for the ACP measurement. The carrier frequency is relative to the center frequency of the measurement. There is only one available reference carrier.

Key Path	Trace/Detector, ACP
Mode	VSA, LTE, LTETDD, IDEN
Measurement	<meas>:=VECTor ADEMod DDEMod W11A W11B EVM IPOWer IDEMod MOTotalk
Remote Command	:CALCulate:<meas>:TRACe[1] 2 3 4:ACPoweR:CARRier: FREQuency <freq> :CALCulate:<meas>:TRACe[1] 2 3 4:ACPoweR:CARRier: FREQuency?
Example	CALC:VECT:TRAC1:ACP:CARR:FREQ 100 KHZ CALC:VECT:TRAC1:ACP:CARR:FREQ?
Preset	0
State Saved	Saved in instrument state.
Min	-9.9e37
Max	9.9e37
Initial S/W Revision	Prior to A.02.00
Modified at S/W Revision	A.02.00

Common Measurement Functions 2

Carrier Meas Noise BW

This key allows you to define the measurement noise bandwidth of the reference channel.

Key Path	Trace/Detector, ACP
Mode	VSA, LTE, LTETDD, IDEN
Measurement	<meas>:=VECTor ADEMod DDEMod W11A W11B EVM IPOWER IDEMod MOTotalk
Remote Command	:CALCulate:<meas>:TRACe[1] 2 3 4:ACPpower:CARRier: BANDwidth BWIDth:INTEgration <bandwidth> :CALCulate:<meas>:TRACe[1] 2 3 4:ACPpower:CARRier: BANDwidth BWIDth:INTEgration?
Example	CALC:VECT:TRAC1:ACP:CARR:BAND:INT 1 MHZ CALC:VECT:TRAC1:ACP:CARR:BAND:INT?
Preset	1000000
State Saved	Saved in instrument state.
Min	-9.9e37
Max	9.9e37
Initial S/W Revision	Prior to A.02.00
Modified at S/W Revision	A.02.00

Carrier RRC Weighting

This key turns on or off RRC weighting for the reference (carrier) power measurement.

Key Path	Trace/Detector, ACP
Mode	VSA, LTE, LTETDD, IDEN
Measurement	<meas>:=VECTor ADEMod DDEMod W11A W11B EVM IPOWER IDEMod MOTotalk
Remote Command	:CALCulate:<meas>:TRACe[1] 2 3 4:ACPpower:CARRier: FILTer:RRC:STATe OFF ON 0 1 :CALCulate:<meas>:TRACe[1] 2 3 4:ACPpower:CARRier: FILTer:RRC:STATe?
Example	CALC:VECT:TRAC1:ACP:CARR:FILT:RRC:STAT ON CALC:VECT:TRAC1:ACP:CARR:FILT:RRC:STAT?
Preset	0
State Saved	Saved in instrument state.
Initial S/W Revision	Prior to A.02.00

Modified at S/W Revision	A.02.00
--------------------------	---------

Carrier Filter Alpha

This key allows you to adjust the alpha of the RRC filter for the reference (carrier) power measurement.

Key Path	Trace/Detector, ACP
Mode	VSA, LTE, LTETDD, IDEN
Measurement	<meas>:=VECTor ADEMod DDEMod W11A W11B EVM IPOWER IDEMod MOTotalk
Remote Command	:CALCulate:<meas>:TRACe[1] 2 3 4:ACPpower:CARRier: FILTer:RRC:ALPHa <real> :CALCulate:<meas>:TRACe[1] 2 3 4:ACPpower:CARRier: FILTer:RRC:ALPHa?
Example	CALC:VECT:TRAC1:ACP:CARR:FILT:RRC:ALPH 0.22 CALC:VECT:TRAC1:ACP:CARR:FILT:RRC:ALPH?
Preset	0.35
State Saved	Saved in instrument state.
Min	0
Max	1
Initial S/W Revision	Prior to A.02.00
Modified at S/W Revision	A.02.00

Offsets

The ACP measurement compares power in frequency bands offset from the carrier to power in the reference channel (centered on the carrier). Up to 5 offsets may be defined. The offsets are designated by letters A through E. Each offset is defined by an offset frequency, bandwidth, and optional RRC weighting. An offset actually defines two bands, one above the reference frequency and one below. Each band is used individually in the ACP calculation. RRC weighting may only be turned on or off for all offsets, but each offset may have its own RRC filter alpha. A filter alpha of 0 is the same as no RRC weighting.

The Offsets key accesses a menu that has a key for each offset, and also an Offset RRC weighting on/off key. Each offset key shows a summary of its current parameters. Pressing one of the Offset A|B|C|D|E keys accesses a menu for adjusting its parameters

Key Path	Trace/Detector, ACP, Offsets
Mode	VSA, LTE, LTETDD, IDEN
Initial S/W Revision	Prior to A.02.00
Modified at S/W Revision	A.02.00

Common Measurement Functions 2

Offset Freq

This key turns ACP analysis on or off for a selected offset, and sets the offset frequency (which is relative to the carrier frequency).

Key Path	Trace/Detector,ACP,Offsets,Offset A B C D E
Mode	VSA, LTE, LTETDD, IDEN
Measurement	<meas>:=VECTor ADEMod DDEMod W11A W11B EVM IPOWER IDEMod MOTotalk
Remote Command	:CALCulate:<meas>:TRACe[1] 2 3 4:ACPpower:OFFSet:LIST: FREQuency <freq>, ... :CALCulate:<meas>:TRACe[1] 2 3 4:ACPpower:OFFSet:LIST: FREQuency? :CALCulate:<meas>:TRACe[1] 2 3 4:ACPpower:OFFSet:LIST: STATe OFF ON 0 1, ... :CALCulate:<meas>:TRACe[1] 2 3 4:ACPpower:OFFSet:LIST: STATe?
Example	CALC:VECT:TRAC1:ACP:OFFS:LIST:FREQ 1 MHZ,1 MHZ,500 KHZ,500 KHZ,1 MHZ CALC:VECT:TRAC1:ACP:OFFS:LIST:FREQ? :CALC:VECT:TRAC1:ACP:OFFS:LIST:STAT ON,OFF,OFF,ON,OFF
Notes	If you send fewer than 5 frequencies in the parameter list, then the remaining offsets frequencies are set to 0. You may send a single on/off parameter, or a comma-separated list of up to 5 parameters. These enable/disable each of the Offsets in sequence. Any remaining Offsets are disabled
Preset	3000000,0,0,0,0 1,0,0,0,0
State Saved	Saved in instrument state.
Min	-9.9E+37
Max	9.9E+37
Initial S/W Revision	Prior to A.02.00
Modified at S/W Revision	A.02.00

Offset Meas Noise BW

This key allows you to set the measurement noise bandwidth for the power measurement of a selected offset band.

Key Path	Trace/Detector,ACP,Offsets,Offset A B C D E
Mode	VSA, LTE, LTETDD, IDEN

Measurement	<meas>:=VECTor ADEMod DDEMod W11A W11B EVM IPOWER IDEMod MOTotalk
Remote Command	:CALCulate:<meas>:TRACe[1] 2 3 4:ACPpower:OFFSet:LIST: BANDwidth BWIDth:INTEgration <bandwidth>,... :CALCulate:<meas>:TRACe[1] 2 3 4:ACPpower:OFFSet:LIST: BANDwidth BWIDth:INTEgration?
Example	CALC:VECT:TRAC1:ACP:OFFS:LIST:BAND:INT 1 MHZ,2 MHZ,3 MHZ,4 MHZ,5 MHZ CALC:VECT:TRAC1:ACP:OFFS:LIST:BAND:INT?
Notes	If you send fewer than 5 bandwidth parameters in the list, then Measurement Noise Bandwidths for the remaining Offsets are set to 0.
Preset	1000000,0,0,0,0
State Saved	Saved in instrument state.
Min	-9.9e37
Max	9.9e37
Initial S/W Revision	Prior to A.02.00
Modified at S/W Revision	A.02.00

Offset Filter Alpha

This key allows you to adjust the alpha of the RRC filter for the power measurement of the selected offset band.

Key Path	Trace/Detector,ACP,Offsets,Offset A B C D E
Mode	VSA, LTE, LTETDD, IDEN
Measurement	<meas>:=VECTor ADEMod DDEMod W11A W11B EVM IPOWER IDEMod MOTotalk
Remote Command	:CALCulate:<meas>:TRACe[1] 2 3 4:ACPpower:OFFSet:LIST: FILTer:RRC:ALPHa <real>,... :CALCulate:<meas>:TRACe[1] 2 3 4:ACPpower:OFFSet:LIST: FILTer:RRC:ALPHa?
Example	CALC:VECT:TRAC1:ACP:OFFS:LIST:FILT:RRC:ALPH 0.22,0.22,0.22,0.22,0.22 CALC:VECT:TRAC1:ACP:OFFS:LIST:FILT:RRC:ALPH?
Notes	You may send a single Filter Alpha for Offset A, or a comma-separated list of up to 5 Filter Alpha parameters. These are assigned in sequence to the Offsets. Alpha for any remaining Offsets will be set to 0.
Preset	0.35,0.35,0.35,0.35,0.35
State Saved	Saved in instrument state.
Min	0

Common Measurement Functions 2

Max	1.0
Initial S/W Revision	Prior to A.02.00
Modified at S/W Revision	A.02.00

Offset Relative Limit

This key enables you to turn on/off a relative limit test and set the limit for the selected offset. The test shows a failure if the power in either the upper or lower band at the selected offset exceeds the reference power plus the relative test limit. For example, if the test limit is -60 , the reference power is -4.5 dBm, a test failure would be shown if the power in the lower or upper band exceeds -64.5 dBm.

Key Path	Trace/Detector,ACP,Offsets
Mode	VSA, LTE, LTETDD, IDEN
Measurement	<meas>:=VECTor ADEMod DDEMod W11A W11B EVM IPOWER IDEMod MOTotalk
Remote Command	:CALCulate:<meas>:TRACe[1] 2 3 4:ACPpower:OFFSet:LIST: RCARrier <reall>, ... :CALCulate:<meas>:TRACe[1] 2 3 4:ACPpower:OFFSet:LIST: RCARrier? :CALCulate:<meas>:TRACe[1] 2 3 4:ACPpower:OFFSet:LIST: RCARrier:TEST OFF ON 0 1, ... :CALCulate:<meas>:TRACe[1] 2 3 4:ACPpower:OFFSet:LIST: RCARrier:TEST?
Example	CALC:VECT:TRAC1:ACP:OFFS:LIST:RCAR -50, -55, -60, -65, -80 CALC:VECT:TRAC1:ACP:OFFS:LIST:RCAR? CALC:VECT:TRAC1:ACP:OFFS:LIST:RCAR:TEST 1, 1, 1, 1, 1 CALC:VECT:TRAC1:ACP:OFFS:LIST:RCAR:TEST?
Notes	You may send a single Limit for Offset A, or a comma-separated list of up to 5 limit parameters. These are assigned in sequence to the Offset frequencies, with the remaining limits being set to 0. You may send a single on/off parameter, or a comma-separated list of up to 5 parameters. These turn the Limit Test on or off for each of the Offsets in sequence. For any remaining Offsets the Limit test will be turned off.
Preset	-120,-120,-120,-120,-120 0,0,0,0,0
State Saved	Saved in instrument state.
Min	50
Max	-200
Initial S/W Revision	Prior to A.02.00
Modified at S/W Revision	A.02.00

RRC Weighting (All Offsets)

This key turns on or off RRC weighting for the power measurement for all offsets. If RRC weighting is turned on, but you wish to exclude RRC weighting for a particular offset, set its filter alpha to 0.

Key Path	Trace/Detector,ACP,Offsets
Mode	VSA, LTE, LTETDD, IDEN
Measurement	<meas>:=VECTor ADEMod DDEMod W11A W11B EVM IPOWER IDEMod MOTotalk
Remote Command	:CALCulate:<meas>:TRACe[1] 2 3 4:ACPpower:OFFSet:FILTer: RRC:STATe OFF ON 0 1 :CALCulate:<meas>:TRACe[1] 2 3 4:ACPpower:OFFSet:FILTer: RRC:STATe?
Example	CALC:VECT:TRAC1:ACP:OFFS:FILT:RRC:STAT ON CALC:VECT:TRAC1:ACP:OFFS:FILT:RRC:STAT?
Preset	0
State Saved	Saved in instrument state.
Initial S/W Revision	Prior to A.02.00
Modified at S/W Revision	A.02.00

OBW Setup (Occupied Bandwidth)

The occupied bandwidth (OBW) function finds and displays the band of frequencies that contain a specified percentage of the total power within the measurement span.

The OBW key accesses a menu of functions that allow you to define and turn on the OBW function on the selected trace.

An OBW measurement may be defined for each trace, although it will only be active on frequency-domain trace data. The band defined by the OBW measurement is shown as a blue bar overlaying the trace display. To see tabular data showing the frequencies of the band limits, the total power, etc. you may assign the OBW Summary (Trace n) to a different trace. For example, you can assign Spectrum data to trace 3, turn on OBW on trace 3, and assign the OBW Summary (Trace 3) to trace 4, as shown below.

Common Measurement Functions 2

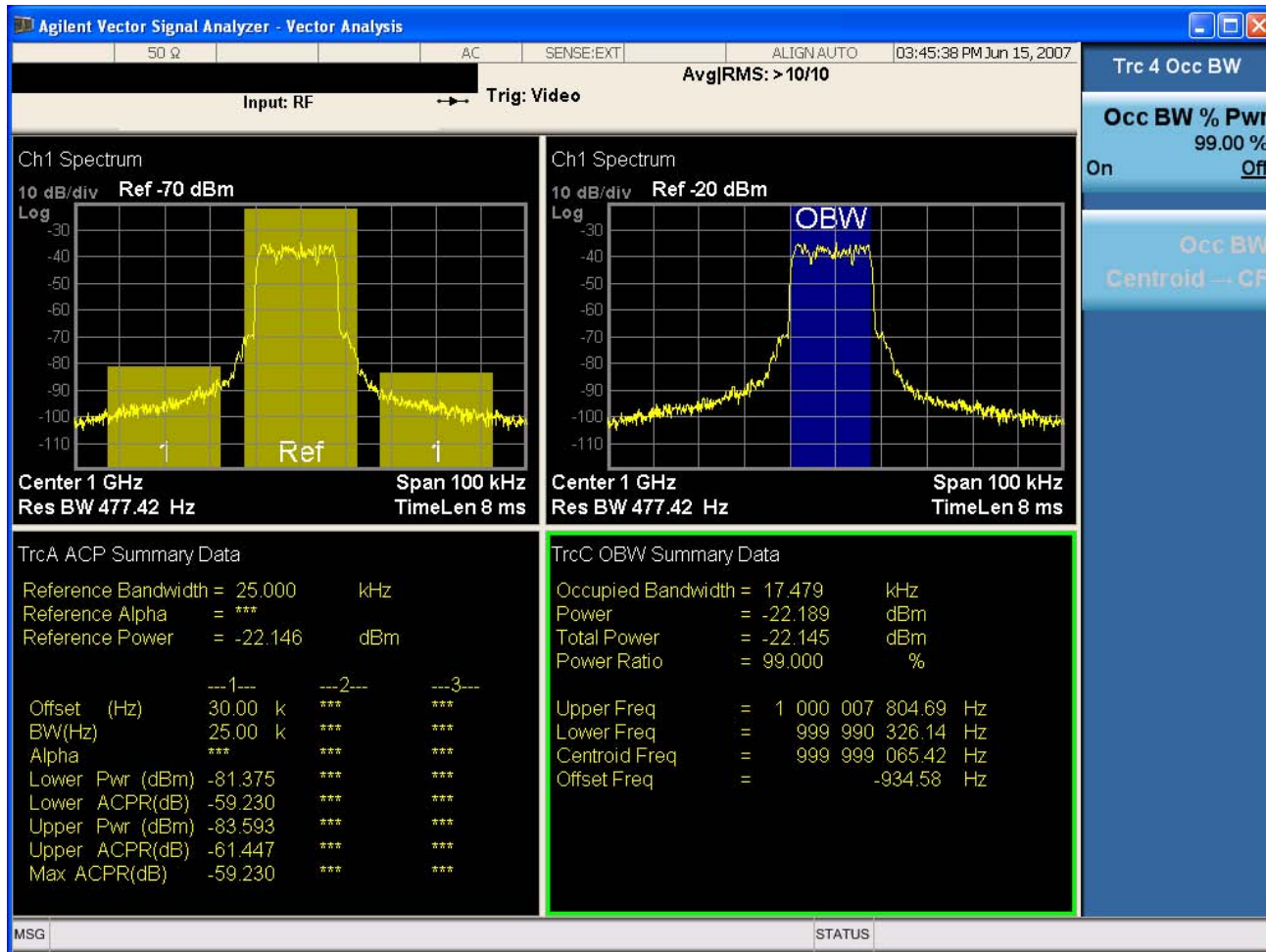

The summary data may be retrieved programmatically using `FETCh?` or the `CALCulate:<meas>:DATA:TABLE` commands. See the Data Queries section under Common Functions for more details.

Key Path	Trace/Detector
Mode	VSA, LTE, LTETDD, IDEN
Readback Text	[On Off, <num>%]
Initial S/W Revision	Prior to A.02.00
Modified at S/W Revision	A.02.00

OBW Power

The OBW Power key is used to specify the percentage of power used to determine the occupied BW, and to turn the OBW function on or off for the selected trace.

Key Path	Trace/Detector, OBW
Mode	VSA, LTE, LTETDD, IDEN

Measurement	<meas>:=VECTor ADEMod DDEMod W11A W11B EVM IPOWer IDEMod MOTotalk
Remote Command	:CALCulate:<meas>:TRACe[1] 2 3 4:OBwidth:PERCent <real> :CALCulate:<meas>:TRACe[1] 2 3 4:OBwidth:PERCent? :CALCulate:<meas>:TRACe[1] 2 3 4:OBwidth:STATe OFF ON 0 1 :CALCulate:<meas>:TRACe[1] 2 3 4:OBwidth:STATe?
Example	CALC:VECT:TRAC1:OBW:PERC 99 CALC:VECT:TRAC1:OBW:PERC? CALC:VECT:TRAC1:OBW:STAT ON CALC:VECT:TRAC1:OBW:STAT?
Notes	Parameter is interpreted as a percent, e.g., if you want the OBW to be 95% send 95, not 0.95
Couplings	None Controls the presence or absence of data in the OBW Summary table for the selected trace
Preset	99.0 0
State Saved	Saved in instrument state.
Min	0
Max	100
Initial S/W Revision	Prior to A.02.00
Modified at S/W Revision	A.02.00

OBW Centroid > CF

This softkey is used to copy the centroid of the occupied bandwidth to the Center Frequency. It only works if the currently selected trace has data compatible with the OBW function, and OBW is turned on.

This is a front-panel function only.

You can read the OBW centroid using the following SCPI-only query and use the result to set the center frequency.

Mode	VSA, LTE, LTETDD, IDEN
Measurement	<meas>:=VECTor ADEMod DDEMod W11A W11B EVM IPOWer IDEMod MOTotalk
Remote Command	:CALCulate:<meas>:TRACe[1] 2 3 4:OBwidth:CENTRoid?
Example	CALC:VECT:TRAC1:OBW:CENT?

Common Measurement Functions 2

Notes	Query only. Returns NaN (9.91E+37) if the OBW function is not active for the selected trace, or is not supported for the trace data assigned to the selected trace.
Initial S/W Revision	Prior to A.02.00
Modified at S/W Revision	A.02.00

BW Limit

This turns on or off limit testing for the Occupied BW test for the selected trace, and allows you to define the limit. Test pass or fail status appears in the OBW Summary table associated with the trace.

Key Path	Trace/Detector, OBW
Mode	VSA, LTE, LTETDD, IDEN
Measurement	<meas>:=VECTor ADEMod DDEMod W11A W11B EVM IPOWer IDEMod MOTotalk
Remote Command	:CALCulate:<meas>:TRACe[1] 2 3 4:OBWidth:LIMit:FBLimit <freq> :CALCulate:<meas>:TRACe[1] 2 3 4:OBWidth:LIMit:FBLimit? :CALCulate:<meas>:TRACe[1] 2 3 4:OBWidth:LIMit[:TEST] OFF ON 0 1 :CALCulate:<meas>:TRACe[1] 2 3 4:OBWidth:LIMit[:TEST]?
Example	CALC:VECT:TRAC1:OBW:LIMIT:FBL 10 MHZ CALC:VECT:TRAC1:OBW:LIMIT:FBL? CALC:VECT:TRAC1:OBW:LIMIT:TEST ON CALC:VECT:TRAC1:OBW:LIMIT:TEST?
Preset	1000000 0
State Saved	Saved in instrument state.
Min	1 Hz
Max	9.9e37 (Infinity) Hz
Initial S/W Revision	Prior to A.02.00
Modified at S/W Revision	A.02.00

Register

Accesses a menu that allows you to select registers for assignment of trace data.

Key Path	Trace/Detector, Data
Mode	VSA, LTE, LTETDD, IDEN

Initial S/W Revision	Prior to A.02.00
Modified at S/W Revision	A.02.00

Data 1

Select register 1 for assignment of trace data.

Key Path	Trace/Detector, Data, Register
Mode	VSA, LTE, LTETDD, IDEN
Initial S/W Revision	Prior to A.02.00
Modified at S/W Revision	A.02.00

Data 2

Selects register 2 for assignment of trace data.

Key Path	Trace/Detector, Data, Register
Mode	VSA, LTE, LTETDD, IDEN
Initial S/W Revision	Prior to A.02.00
Modified at S/W Revision	A.02.00

Data 3

Selects register 3 for assignment of trace data.

Key Path	Trace/Detector, Data, Register
Mode	VSA, LTE, LTETDD, IDEN
Initial S/W Revision	Prior to A.02.00
Modified at S/W Revision	A.02.00

Data 4

Selects register 4 for assignment of trace data.

Key Path	Trace/Detector, Data, Register
Mode	VSA, LTE, LTETDD, IDEN
Initial S/W Revision	Prior to A.02.00
Modified at S/W Revision	A.02.00

Common Measurement Functions 2

Data 5

Selects register 5 for assignment of trace data.

Key Path	Trace/Detector, Data, Register
Mode	VSA
Initial S/W Revision	Prior to A.02.00
Modified at S/W Revision	A.02.00

Data 6

Selects register 6 for assignment of trace data.

Key Path	Trace/Detector, Data, Register
Mode	VSA
Initial S/W Revision	Prior to A.02.00
Modified at S/W Revision	A.02.00

Trace Indicator Info

This softkey allows you to get more information about why a trace indicator is showing. A trace indicator appears in the upper right corner of a trace display to announce exceptional conditions. When such an indicator is showing on the selected trace, pressing this key causes more information about the condition to appear in the message area. This is a front-panel only function. The SCPI commands for querying the Trace Indicator and the Trace Indicator Info for a particular trace are:

```
CALC:<meas>:DATA[1]|2|3|4:HEAD:STR? "TrcLedStr"
```

```
CALC:<meas>:DATA[1]|2|3|4:HEAD:STR? "TrcLedReason"
```

Key Path	Trace/Detector
Mode	VSA, LTE, LTETDD, IDEN
Initial S/W Revision	Prior to A.02.00
Modified at S/W Revision	A.02.00

Trigger

Triggering is used to determine when a measurement should start taking data. There are several available trigger sources. For each trigger source, there are associated setup parameters. Typically, a trigger event is generated when a signal (or a characteristic of the signal) crosses a defined trigger level (or threshold) on a rising or falling slope. The measurement begins at a specified time delay from the trigger point. The delay may be negative, allowing pre-trigger data to be taken. Each trigger source has associated its own trigger level, slope, and delay settings.

Trigger Holdoff - Some form of trigger holdoff is available for most trigger types. Hold off can be defined in different ways, with possible variations depending on trigger slope setting.

Normal: This is the holdoff type that scopes typically use. After a trigger event, for the duration of the holdoff time, no additional trigger events are recognized.

Below Level: If the trigger slope is positive, a trigger event is generated only if the signal characteristic of interest crosses the trigger threshold (with positive slope) after having been below the threshold for at least the holdoff time. For negative slope, the trigger event is generated if the signal characteristic crosses the threshold (with negative slope) and then remains below the threshold for at least the holdoff time. In either case, the trigger event is associated with the time the level was crossed.

Above Level: If the trigger slope is positive, a trigger event is generated only if the signal characteristic of interest crosses the trigger threshold (with positive slope) and then remains above the threshold for at least the holdoff time. For negative slope, the trigger event is generated if the signal characteristic crosses the threshold (with negative slope) after having been above the threshold for at least the holdoff time. In either case, the trigger event is associated with the time the level was crossed.

Key Path	Front Panel
Mode	VSA, LTE, LTETDD, IDEN
Initial S/W Revision	Prior to A.02.00
Modified at S/W Revision	A.02.00

Trig Reference Line

The trigger reference line appears (if enabled) when the trigger source is related to the measured signal. It shows the trigger level relative to the signal. This control allows you to show or hide the trigger reference line.

The trigger reference line, only appears on appropriately formatted time traces. For example, if Video (IF Envelope) trigger is selected, the trigger level line would appear on Main Time, Inst Main Time, or Raw Main Time traces that are formatted as Log Mag or Linear Mag.

Key Path	Trigger
Mode	VSA, LTE, LTETDD, IDEN
Remote Command	:TRIGger[:SEquence]:RLINe OFF ON 0 1 :TRIGger[:SEquence]:RLINe?
Example	TRIG:RLIN ON TRIG:RLIN?
Preset	1
State Saved	Saved in instrument state.
Range	Show Hide
Initial S/W Revision	Prior to A.02.00
Modified at S/W Revision	A.02.00

Common Measurement Functions 2

Hardware Trigger

When the Data Source is Inputs, this trigger menu appears. The menu gives you a choice of trigger sources. Once you select a trigger source, you can branch to the setup parameters for that source.

Key Path	Trigger
Mode	VSA, LTE, LTETDD, IDEN
Measurement	<meas>:=VECTor ADEMod DDEMod W11A W11B EVM IPOWer IDEMod MOTotalk
Remote Command	:TRIGger:<meas>[:SEQuence]:SOURce IMMediate VIDeo EXTernal1 :TRIGger:<meas>[:SEQuence]:SOURce?
Example	TRIG:VECT:SOUR IMM TRIG:VECT:SOUR?
Notes	Video triggering is also known by some as IF Envelope or IF Magnitude triggering.
Preset	IMM
State Saved	Saved in instrument state.
Range	Free Run Video (IF Envelope) External 1
Initial S/W Revision	Prior to A.02.00
Modified at S/W Revision	A.02.00

Free Run

Free Run triggering, means each measurement scan starts as soon as possible, without regard to any signal characteristics or external triggering signal.

Key Path	Trigger
Mode	VSA, LTE, LTETDD, IDEN
Initial S/W Revision	Prior to A.02.00
Modified at S/W Revision	A.02.00

Video (IF Envelope)

Pressing this key, when it is not selected, selects Video (IF Envelope) triggering. The trigger condition is met when the magnitude of the signal you are measuring crosses the defined trigger level while satisfying the slope and holdoff conditions. (Specifically, the source for the trigger calculation is the IF signal, filtered only by the brickwall filter that defines the information bandwidth of the signal, Signal energy outside the information bandwidth does not affect the triggering.)

NOTE This is called Video triggering due to its similarity with swept analyzer zero span

measurements being triggered on the video signal. However, in this case there is no video signal. Since the trigger condition applies to the full IF signal, this is also called IF envelope triggering.

If Video triggering is already selected then pressing this softkey accesses the video trigger setup functions, and changes the active function to Video Trigger Level.

Key Path	Trigger
Mode	VSA, LTE, LTETDD, IDEN
Initial S/W Revision	Prior to A.02.00
Modified at S/W Revision	A.02.00

Trigger Level

Sets a level (in volts) that the magnitude of the IF signal must cross (with the correct slope) in order to generate a trigger. (Holdoff conditions must also be met.)

Key Path	Trigger,Video
Mode	VSA, LTE, LTETDD, IDEN
Remote Command	:TRIGger[:SEQuence]:VIDeo:LEVel <voltage> :TRIGger[:SEQuence]:VIDeo:LEVel?
Example	TRIG:VID:LEV 10 MV TRIG:VID:LEV?
Notes	:TRIGger[:SEQuence]:IF:LEVel <voltage> may be used as an alias
Preset	10 mV
State Saved	Saved in instrument state.
Min	0
Max	9.9E+37
Initial S/W Revision	Prior to A.02.00
Modified at S/W Revision	A.02.00

Trig Slope

Controls the trigger polarity. Positive means the trigger occurs when the rising magnitude crosses the trigger level. Negative means the trigger occurs when the falling magnitude crosses the trigger level.

Key Path	Trigger,Video
Mode	VSA, LTE, LTETDD, IDEN
Remote Command	:TRIGger[:SEQuence]:VIDeo:SLOPe POSitive NEGative :TRIGger[:SEQuence]:VIDeo:SLOPe?

Common Measurement Functions 2

Example	TRIG:VID:SLOP POS TRIG:VID:SLOP?
Notes	:TRIGger[:SEQuence]:IF:SLOPe POSitive NEGative may also be used
Preset	POS
State Saved	Saved in instrument state.
Range	Pos Neg
Initial S/W Revision	Prior to A.02.00
Modified at S/W Revision	A.02.00

Trig Delay

Controls the time delay from the trigger point to the actual start of the measurement data. This can be negative to get pre-trigger data.

Key Path	Trigger,Video
Mode	VSA, LTE, LTETDD, IDEN
Remote Command	:TRIGger[:SEQuence]:VIDeo:DELAy <time> :TRIGger[:SEQuence]:VIDeo:DELAy? :TRIGger[:SEQuence]:VIDeo:DELAy:STATe OFF ON 0 1 :TRIGger[:SEQuence]:VIDeo:DELAy:STATe?
Example	TRIG:VID:DEL 10 MS TRIG:VID:DEL? TRIG:VID:DEL:STAT ON TRIG:VID:DEL:STAT?
Notes	:TRIGger[:SEQuence]:IF:DELAy <time> may be used as an alias :TRIGger[:SEQuence]:IF:DELAy:STATe may also be used as an alias
Preset	0 OFF
State Saved	Saved in instrument state.
Min	-9.9E+37
Max	9.9E+37
Initial S/W Revision	Prior to A.02.00
Modified at S/W Revision	A.02.00

Trig Holdoff

Sets the trigger holdoff time.

Key Path	Trigger,Video
Mode	VSA, LTE, LTETDD, IDEN
Remote Command	:TRIGger[:SEQuence]:VIDeo:HOLDoFF <time> :TRIGger[:SEQuence]:VIDeo:HOLDoFF? :TRIGger[:SEQuence]:VIDeo:HOLDoFF:STATe OFF ON 0 1 :TRIGger[:SEQuence]:VIDeo:HOLDoFF:STATe?
Example	TRIG:VID:HOLD 1 US TRIG:VID:HOLD? TRIG:VID:HOLD:STAT ON TRIG:VID:HOLD:STAT?
Notes	:TRIGger[:SEQuence]:IF:HOLDoFF may be used as an alias :TRIGger[:SEQuence]:IF:HOLDoFF:STATe may be used as an alias
Preset	0 OFF
State Saved	Saved in instrument state.
Min	-9.9E+37
Max	9.9E+37
Initial S/W Revision	Prior to A.02.00
Modified at S/W Revision	A.02.00

Holdoff Type

Sets the trigger holdoff type.

Some form of trigger holdoff is available for most trigger types. Hold off can be defined in different ways, with possible variations depending on trigger slope setting.

Below Level: If the trigger slope is positive, a trigger event is generated only if the signal characteristic of interest crosses the trigger threshold (with positive slope) after having been below the threshold for at least the holdoff time. For negative slope, the trigger event is generated if the signal characteristic crosses the threshold (with negative slope) and then remains below the threshold for at least the holdoff time. In either case, the trigger event is associated with the time the level was crossed.

Above Level: If the trigger slope is positive, a trigger event is generated only if the signal characteristic of interest crosses the trigger threshold (with positive slope) and then remains above the threshold for at least the holdoff time. For negative slope, the trigger event is generated if the signal characteristic crosses the threshold (with negative slope) after having been above the threshold for at least the holdoff time. In either case, the trigger event is associated with the time the level was crossed.

Key Path	Trigger,Video
----------	----------------------

Common Measurement Functions 2

Mode	VSA, LTE, LTETDD, IDEN
Remote Command	:TRIGger[:SEquence]:VIDeo:HOLDoff:TYPE BELow ABOve :TRIGger[:SEquence]:VIDeo:HOLDoff:TYPE?
Example	TRIG:VID:HOLD:TYPE BEL TRIG:VID:HOLD:TYPE?
Notes	:TRIGger[:SEquence]:IF:HOLDoff:TYPE can be used as an alias
Preset	BEL
State Saved	Saved in instrument state.
Range	Below Level Above Level
Initial S/W Revision	Prior to A.02.00
Modified at S/W Revision	A.02.00

External 1

Pressing this key, when it is not selected, selects the signal on the Trigger 1 input as the trigger signal. The trigger condition is met when the level of the external trigger signal crosses the defined trigger level while satisfying the slope and holdoff conditions.

Note that currently, the VSA based measurements do not support External 2 triggering.

If External 1 triggering is already selected then pressing this softkey accesses the external 1 trigger setup functions, and changes the active function to Ext 1 Trigger Level.

Key Path	Trigger
Mode	VSA, LTE, LTETDD, IDEN
Initial S/W Revision	Prior to A.02.00
Modified at S/W Revision	A.02.00

Trigger Level

Sets a level (in volts) that the Trigger signal must cross (with the correct slope) in order to generate a trigger. (Holdoff conditions must also be met.)

Key Path	Trigger, External 1
Mode	VSA, LTE, LTETDD, IDEN
Remote Command	:TRIGger[:SEquence]:EXTErnal1:LEVel <voltage> :TRIGger[:SEquence]:EXTErnal1:LEVel?
Example	TRIG:EXT1:LEV 10 MV TRIG:EXT1:LEV?
Preset	1 V

State Saved	Saved in instrument state.
Min	-9.9E+37
Max	9.9E+37
Initial S/W Revision	Prior to A.02.00
Modified at S/W Revision	A.02.00

Trig Slope

Controls the trigger polarity. Positive means the trigger occurs on a rising edge. Negative means the trigger occurs on a falling edge.

Key Path	Trigger, External 1
Mode	VSA, LTE, LTETDD, IDEN
Remote Command	:TRIGger[:SEquence]:EXTernal1:SLOPe POSitive NEGative :TRIGger[:SEquence]:EXTernal1:SLOPe?
Example	TRIG:EXT1:SLOP POS TRIG:EXT1:SLOP?
Preset	POS
State Saved	Saved in instrument state.
Range	Pos Neg
Initial S/W Revision	Prior to A.02.00
Modified at S/W Revision	A.02.00

Trig Delay

Controls the time delay from the trigger point to the actual start of the measurement data. This can be negative to get pre-trigger data.

Key Path	Trigger, External 1
Mode	VSA, LTE, LTETDD, IDEN
Remote Command	:TRIGger[:SEquence]:EXTernal1:DELay <time> :TRIGger[:SEquence]:EXTernal1:DELay? :TRIGger[:SEquence]:EXTernal1:DELay:STATe OFF ON 0 1 :TRIGger[:SEquence]:EXTernal1:DELay:STATe?
Example	TRIG:EXT1:DEL 10 MS TRIG:EXT1:DEL? TRIG:EXT1:DEL:STAT ON TRIG:EXT1:DEL:STAT?

Common Measurement Functions 2

Preset	0 0
State Saved	Saved in instrument state.
Min	-9.9E+37
Max	9.9E+37
Initial S/W Revision	Prior to A.02.00
Modified at S/W Revision	A.02.00

Trig Holdoff

Sets the trigger holdoff time.

Key Path	Trigger, External 1
Mode	VSA, LTE, LTETDD, IDEN
Remote Command	:TRIGger[:SEquence]:EXTErnal1:HOLDoff <time> :TRIGger[:SEquence]:EXTErnal1:HOLDoff? :TRIGger[:SEquence]:EXTErnal1:HOLDoff:STATe OFF ON 0 1 :TRIGger[:SEquence]:EXTErnal1:HOLDoff:STATe?
Example	TRIG:EXT1:HOLD 1 US TRIG:EXT1:HOLD? TRIG:EXT1:HOLD:STAT ON TRIG:EXT1:HOLD:STAT?
Preset	0 0
State Saved	Saved in instrument state.
Min	-9.9E+37
Max	9.9E+37
Initial S/W Revision	Prior to A.02.00
Modified at S/W Revision	A.02.00

Holdoff Type

Sets the trigger holdoff type.

Some form of trigger holdoff is available for most trigger types. Hold off can be defined in different ways, with possible variations depending on trigger slope setting.

Below Level: If the trigger slope is positive, a trigger event is generated only if the signal characteristic of interest crosses the trigger threshold (with positive slope) after having been below the threshold for at least the holdoff time. For negative slope, the trigger event is generated if the signal characteristic crosses the threshold (with

negative slope) and then remains below the threshold for at least the holdoff time. In either case, the trigger event is associated with the time the level was crossed.

Above Level: If the trigger slope is positive, a trigger event is generated only if the signal characteristic of interest crosses the trigger threshold (with positive slope) and then remains above the threshold for at least the holdoff time. For negative slope, the trigger event is generated if the signal characteristic crosses the threshold (with negative slope) after having been above the threshold for at least the holdoff time. In either case, the trigger event is associated with the time the level was crossed.

Key Path	Trigger, External 1
Mode	VSA, LTE, LTETDD, IDEN
Remote Command	:TRIGger[:SEquence]:EXTErnal1:HOLDoff:TYPE BELow ABOVe :TRIGger[:SEquence]:EXTErnal1:HOLDoff:TYPE?
Example	TRIG:EXT1:HOLD:TYPE BEL TRIG:EXT1:HOLD:TYPE?
Preset	BEL
State Saved	Saved in instrument state.
Range	Below Level Above Level
Initial S/W Revision	Prior to A.02.00
Modified at S/W Revision	A.02.00

Free Run

Selecting this trigger source means the measurement immediately begins taking data starting at the next available point in the recording.

Key Path	Trigger, Playback Trigger
Mode	VSA, LTE, LTETDD, IDEN

IF Envelope

Pressing this key selects IF Envelope triggering. The trigger condition is met when the calculated magnitude of the data in the recording. (i.e., the absolute value of real data, or the vector magnitude of complex data) crosses the defined trigger level while satisfying the slope and holdoff conditions.. There is no filtering or smoothing of the magnitude data.

Note: Although analysis of recorded data allows you to chose a different span and center frequency within the bandwidth limits of the original recording, the original bandwidth of the recorded data is used for trigger calculations,

If IF Envelope triggering is already selected then pressing this softkey accesses the IF Envelope trigger setup functions, and changes the active function to IF Envelope Trigger Level.

Key Path	Trigger
Mode	VSA, LTE, LTETDD, IDEN

Common Measurement Functions 2

Trigger Level

Sets a level (in volts) that the magnitude of the IF signal must cross (with the correct slope) in order to generate a trigger.

NOTE Holdoff conditions must also be met.

Key Path	Trigger, IF Envelope
Mode	VSA, LTE, LTETDD, IDEN
Remote Command	:TRIGger[:SEquence]:RECOrding:VIDeo:LEVel <voltage> :TRIGger[:SEquence]:RECOrding:VIDeo:LEVel?
Example	TRIG:REC:VID:LEV 10 MV TRIG:REC:VID:LEV?
Notes	:TRIGger[:SEquence]:RECOrding:IF:LEVel <voltage> may be used as an alias
Preset	1 V
State Saved	Saved in instrument state.
Min	0
Max	9.9E+37

Trig Slope

Controls the trigger polarity. Positive means the trigger occurs when the rising magnitude crosses the trigger level. Negative means the trigger occurs when the falling magnitude crosses the trigger level.

Key Path	Trigger, Video
Mode	VSA, LTE, LTETDD, IDEN
Remote Command	:TRIGger[:SEquence]:RECOrding:VIDeo:SLOPe POSitive NEGative :TRIGger[:SEquence]:RECOrding:VIDeo:SLOPe?
Example	TRIG:REC:VID:SLOP POS TRIG:REC:VID:SLOP?
Notes	:TRIGger[:SEquence]:RECOrding:IF:SLOPe may be used as an alias
Preset	POS
State Saved	Saved in instrument state.
Range	Pos Neg

Trig Delay

Controls the time delay from the trigger point to the actual start of the measurement data. This can be negative to get pre-trigger data.

Key Path	Trigger,Video
Mode	VSA, LTE, LTETDD, IDEN
Remote Command	:TRIGger[:SEquence]:RECORDing:VIDeo:DELay <time> :TRIGger[:SEquence]:RECORDing:VIDeo:DELay? :TRIGger[:SEquence]:RECORDing:VIDeo:DELay:STATe OFF ON 0 1 :TRIGger[:SEquence]:RECORDing:VIDeo:DELay:STATe?
Example	TRIG:REC:VID:DEL 10 MS TRIG:REC:VID:DEL? TRIG:REC:VID:DEL:STAT ON TRIG:REC:VID:DEL:STAT?
Notes	:TRIGger[:SEquence]:RECORDing:IF:DELay <time> may be used as an alias :TRIGger[:SEquence]:RECORDing:IF:DELay:STATe may be used as an alias
Preset	0 0
State Saved	Saved in instrument state.
Min	-9.9E+37
Max	9.9E+37

Trig Holdoff

Sets the trigger holdoff time.

Key Path	Trigger,Video
Mode	VSA, LTE, LTETDD, IDEN
Remote Command	:TRIGger[:SEquence]:RECORDing:VIDeo:HOLDoff <time> :TRIGger[:SEquence]:RECORDing:VIDeo:HOLDoff? :TRIGger[:SEquence]:RECORDing:VIDeo:HOLDoff:STATe OFF ON 0 1 :TRIGger[:SEquence]:RECORDing:VIDeo:HOLDoff:STATe?

Common Measurement Functions 2

Example	TRIG:REC:VID:HOLD 1 US TRIG:REC:VID:HOLD? TRIG:REC:VID:HOLD:STAT ON TRIG:REC:VID:HOLD :STAT?
Notes	:TRIGger[:SEQuence]:RECOding:IF:HOLDoff may be used as an alias :TRIGger[:SEQuence]:RECOding:IF:HOLDoff:STATe may be used as an alias
Preset	0 0
State Saved	Saved in instrument state.
Min	-9.9E+37
Max	9.9E+37

Holdoff Type

Sets the trigger holdoff type.

Some form of trigger holdoff is available for most trigger types. Hold off can be defined in different ways, with possible variations depending on trigger slope setting.

Below Level: If the trigger slope is positive, a trigger event is generated only if the signal characteristic of interest crosses the trigger threshold (with positive slope) after having been below the threshold for at least the holdoff time. For negative slope, the trigger event is generated if the signal characteristic crosses the threshold (with negative slope) and then remains below the threshold for at least the holdoff time. In either case, the trigger event is associated with the time the level was crossed.

Above Level: If the trigger slope is positive, a trigger event is generated only if the signal characteristic of interest crosses the trigger threshold (with positive slope) and then remains above the threshold for at least the holdoff time. For negative slope, the trigger event is generated if the signal characteristic crosses the threshold (with negative slope) after having been above the threshold for at least the holdoff time. In either case, the trigger event is associated with the time the level was crossed.

Key Path	Trigger,Video
Mode	VSA, LTE, LTETDD, IDEN
Remote Command	:TRIGger[:SEQuence]:RECOding:VIDeo:HOLDoff:TYPE BELow ABOve :TRIGger[:SEQuence]:RECOding:VIDeo:HOLDoff:TYPE?
Example	TRIG:REC:VID:HOLD:TYPE BEL TRIG:REC:VID:HOLD:TYPE?
Notes	:TRIGger[:SEQuence]:RECOding:IF:HOLDoff:TYPE can be used as an alias
Preset	BEL
State Saved	Saved in instrument state.

Range	Below Level Above Level
-------	---------------------------

Baseband

Pressing this key, when it is not selected, selects Baseband triggering. It is equivalent to oscilloscope triggering.

NOTE This trigger type is most useful with recorded data that is real (baseband). It is allowed (though not very useful) when the data is complex. In this case the only the real part of the data is used to calculate the trigger condition.

The trigger condition is met when the signal (or the real part of the complex signal) crosses the defined trigger level while satisfying the slope and holdoff conditions. The measurement starts at the trigger point plus the Trigger Delay. Note that the trigger delay may be negative, causing the measurement to start before the trigger point.

If Level triggering is already selected then pressing this softkey accesses the trigger setup functions, and changes the active function to Level Trigger Level.

Key Path	Trigger
Mode	VSA, LTE, LTETDD, IDEN

Trigger Level

Sets a level (in volts) that the trigger signal must cross (with the correct slope) in order to generate a trigger. (Holdoff conditions must also be met.)

Key Path	Trigger, Threshold
Mode	VSA, LTE, LTETDD, IDEN
Remote Command	:TRIGger[:SEquence]:RECOrding:BASEband:LEVEl <voltage> :TRIGger[:SEquence]:RECOrding:BASEband:LEVEl?
Example	TRIG:REC:BAS:LEV 10 MV TRIG:REC:BAS:LEV?
Preset	0 V
State Saved	Saved in instrument state.
Min	-9.9E+37
Max	9.9E+37

Trig Slope

Controls the trigger polarity. Positive means the trigger occurs on a rising edge. Negative means the trigger occurs on a falling edge.

Key Path	Trigger, Threshold
----------	---------------------------

Common Measurement Functions 2

Mode	VSA, LTE, LTETDD, IDEN
Remote Command	:TRIGger[:SEQuence]:RECORDing:BASEband:SLOPe POSitive NEGative :TRIGger[:SEQuence]:RECORDing:BASEband:SLOPe?
Example	TRIG:REC:BAS:SLOP POS TRIG:REC:BAS:SLOP?
Preset	POS
State Saved	Saved in instrument state.
Range	Pos Neg

Trig Delay

Controls the time delay from the trigger point to the actual start of the measurement data. This can be negative to get pre-trigger data.

Key Path	Trigger, Threshold
Mode	VSA, LTE, LTETDD, IDEN
Remote Command	:TRIGger[:SEQuence]:RECORDing:BASEband:DELay <time> :TRIGger[:SEQuence]:RECORDing:BASEband:DELay? :TRIGger[:SEQuence]:RECORDing:BASEband:DELay:STATe OFF ON 0 1 :TRIGger[:SEQuence]:RECORDing:BASEband:DELay:STATe?
Example	TRIG:REC:BAS:DEL 10 MS TRIG:REC:BAS:DEL? TRIG:REC:BAS:DEL:STAT ON TRIG:REC:BAS:DEL:STAT?
Preset	0 0
State Saved	Saved in instrument state.
Min	-9.9E+37
Max	9.9E+37

Trig Holdoff

Sets the trigger holdoff time.

Key Path	Trigger, Threshold
Mode	VSA, LTE, LTETDD, IDEN

Remote Command	:TRIGger[:SEquence]:RECORDing:BASEband:HOLDoff <time> :TRIGger[:SEquence]:RECORDing:BASEband:HOLDoff?
Example	TRIG:REC:BAS:HOLD 1 US TRIG:REC:BAS:HOLD? TRIG:REC:BAS:HOLD:STAT ON TRIG:REC:BAS:HOLD:STAT?
Preset	0 0
State Saved	Saved in instrument state.
Min	-9.9E+37
Max	9.9E+37

Holdoff Type

Sets the trigger holdoff type.

Some form of trigger holdoff is available for most trigger types. Hold off can be defined in different ways, with possible variations depending on trigger slope setting.

Below Level: If the trigger slope is positive, a trigger event is generated only if the signal characteristic of interest crosses the trigger threshold (with positive slope) after having been below the threshold for at least the holdoff time. For negative slope, the trigger event is generated if the signal characteristic crosses the threshold (with negative slope) and then remains below the threshold for at least the holdoff time. In either case, the trigger event is associated with the time the level was crossed.

Above Level: If the trigger slope is positive, a trigger event is generated only if the signal characteristic of interest crosses the trigger threshold (with positive slope) and then remains above the threshold for at least the holdoff time. For negative slope, the trigger event is generated if the signal characteristic crosses the threshold (with negative slope) after having been above the threshold for at least the holdoff time. In either case, the trigger event is associated with the time the level was crossed.

Key Path	Trigger, Threshold
Mode	VSA, LTE, LTETDD, IDEN
Remote Command	:TRIGger[:SEquence]:RECORDing:BASEband:HOLDoff:TYPE BELOW ABOVE :TRIGger[:SEquence]:RECORDing:BASEband:HOLDoff:TYPE?
Example	TRIG:REC:BAS:HOLD:TYPE BEL TRIG:REC:BAS:HOLD:TYPE?
Preset	BEL
State Saved	Saved in instrument state.
Range	Below Level Above Level

View/Display

The View/Display menu contains the Display branch key, which allows you to set many display properties. Many View Preset softkeys appear under this menu. These set up measurement-specific views, which are described in individual measurements. A view in this application is simply a preset; i.e., a choice of layout, trace data assignment, and trace formatting and scaling. After a view preset is performed, the resulting arrangement can then be changed by any available trace manipulation functions or by changing the layout. All measurements have a default view that is used when they are first started, and the first listed preset view will restore that arrangement without otherwise affecting the measurement.

This menu contains keys that allow control over the way data is displayed. The Layout key is described here. Other keys specific to measurements will be described in their own descriptions.

Key Path	Front Panel
Mode	VSA, LTE, LTETDD, IDEN
Initial S/W Revision	Prior to A.02.00
Modified at S/W Revision	A.02.00

Layout

This key allows you to choose the number and position of windows on the screen. Each window contains one trace. The selected trace is always visible and its window outlined in green. The Window zoom key toggles between multiple windows and a single window mode without changing the setting for Layout.

Single layout has one window.

Stack 2 layout has two windows, one on top of the other, that display either traces 1 (top) and 2 (bottom) or traces 3 and 4. The pair that is showing always includes the selected trace.

Stack 3 layout has three windows that display, top to bottom, traces 1, 2, 3 or traces 2, 3, 4.

Grid 2x2 layout has 4 windows, arranged 2x2. They display (in order top to bottom, left to right) traces 1, 2, 3, and 4.

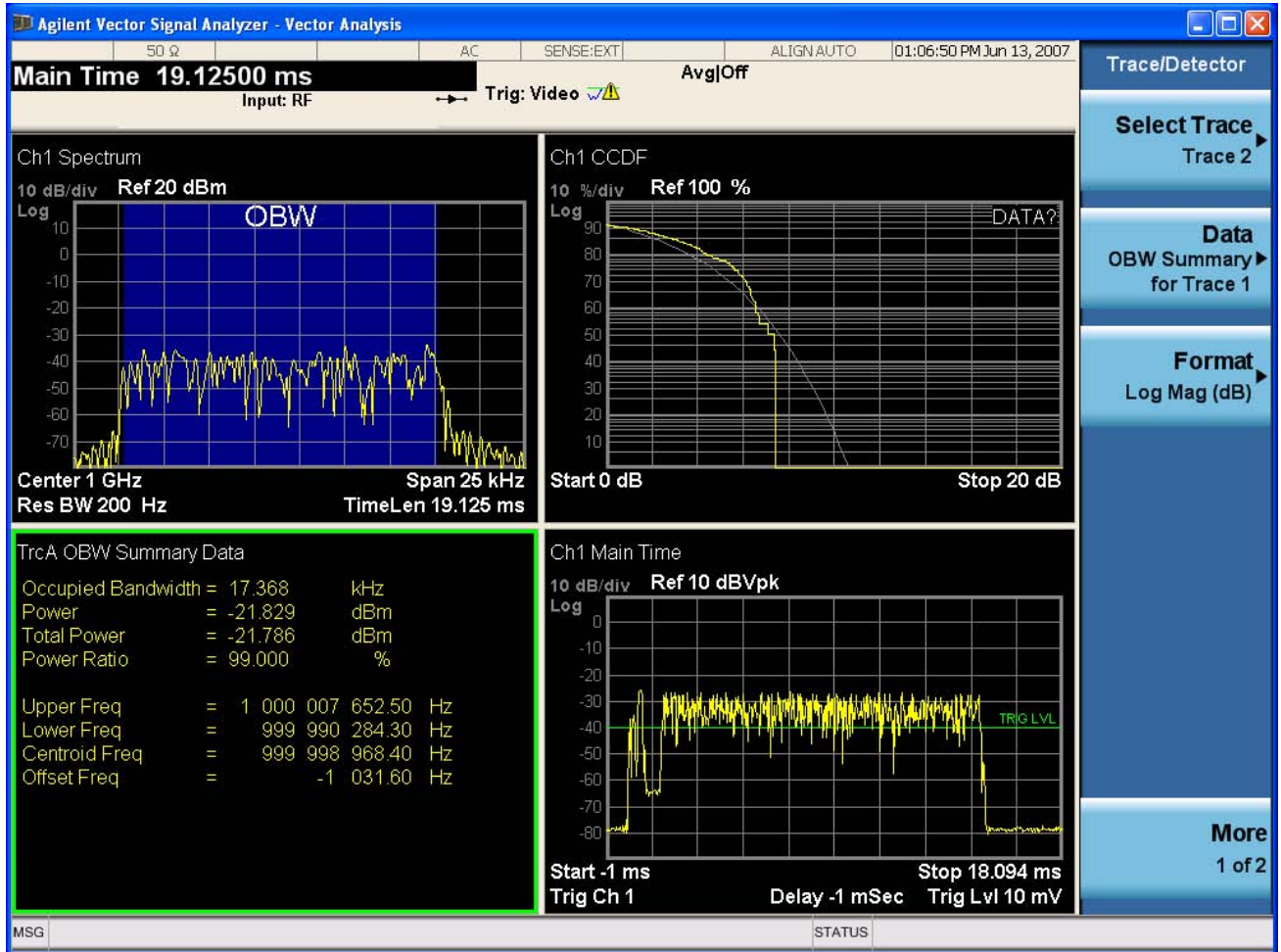

Grid 2x2 layout with Trace 2 selected

There are two other layouts that are available for iDEN Power, iDEN Demod and MOTOTalk measurements, since these allow 6 traces.

Grid 2x3 layout has 2 rows of 3 windows that display all 6 traces in order, top to bottom, then left to right.

Grid 3x2 layout has 3 rows of 2 windows that display all 6 traces in order, top to bottom, then left to right.

Common Measurement Functions 2

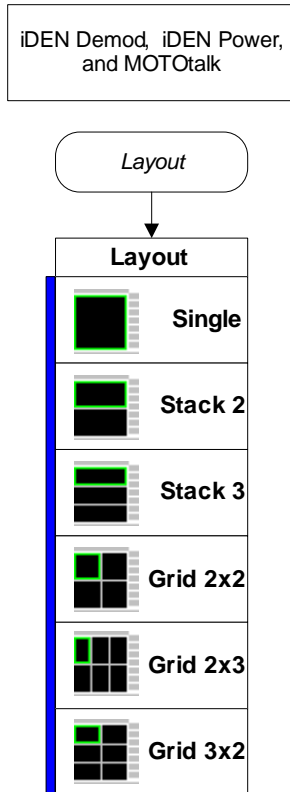

Key Path	View/Display
Mode	VSA, LTE, LTETDD, IDEN
Measurement	<meas>:=VECTor ADEMod DDEMod W11A W11B EVM IPOWer IDEMod MOTotalk
Remote Command	<pre>:DISPlay:<meas>:WINDow:FORMat SINGLE TWO TRI QUAD :DISPlay:<meas>:WINDow:FORMat? For iDEN Power, iDEN Demod and MotoTalk measurements: :DISPlay:<meas>:WINDow:FORMat SINGLE TWO TRI QUAD GR2X3 GR3X2 :DISPlay:<meas>:WINDow:FORMat?</pre>
Example	<pre>DISP:VECT:WIND:FORM TWO DISP:IPOW:WIND:FORM GR2X3 DISP:VECT:WIND:FORM?</pre>
Couplings	If the window is currently zoomed, selecting a layout (even the current one) will switch it to tiled mode.
Preset	TWO QUAD QUAD QUAD QUAD QUAD QUAD QUAD GR2X3 TRI
State Saved	Saved in instrument state.
Range	Single Stack 2 Stack 3 Grid 2x2 Grid 2x2 Grid 2x3 Stack 3

Initial S/W Revision	Prior to A.02.00
Modified at S/W Revision	A.02.00

Remote SCPI Commands and Data Queries

Remote SCPI Results described in this section include:

“:READ and :FETCh Commands” on page 1789

“:CALCulate:DATA” on page 1793

“:CALCulate:DATA:RAW” on page 1794

“:CALCulate:DATA:RAW:COMPLex” on page 1795

“:CALCulate:DATA:POINts commands” on page 1795

“:CALCulate:DATA:TABL commands” on page 1796

“:CALCulate:DATA:HEADer commands” on page 1800

“IQ Data Transfers ” on page 1803

VSA based Measurements produce a rich variety of results which may be displayed in any of 4 traces. A result may consist of an array of X,Y trace data that is typically shown as a graph, or scalar results that are displayed as a table. The Symbol/Error result that is part of many demodulation measurements actually displays both a trace table (the error statistics) and trace data (the symbol information, which is not graphed but listed). The CALC:<meas>:DATA<n> commands allow you to retrieve any trace data or trace table. This family of commands also allow you to get information about the names of data results available and the units associated with them, as well as names and results of meta-data associated with traces.

Selected results are available via the FETCh and READ SCPI interfaces. These commands refer to data results by arbitrary index number rather than by trace number.

:READ and :FETCh Commands

The SCPI MEASure, READ, and FETCh are typically offered by applications with focus on manufacturing test, where a fixed set of desired results is known in advance and seldom changes. The VSA based measurements are many, due to a focus on development. Thus, for most VSA based measurements there is no standard configuration that will yield a useful measurement 90% of the time. Thus, the MEASure function will not be offered for most measurements in the VSA Application. However, READ and FETCh may be implemented for select results. Note that these results will also still be available using the CALC:<meas>:DATA:TABLE family of commands.

ACP and OBW are available in all VSA based measurements. To retrieve the ACP or OBW data, the function must be enabled on a frequency-domain trace and the associated summary data table must be assigned to another trace. Note however, the index n in the following commands is not trace number, but an index picked out of the tables shown below.

:FETCh:<meas>[n]?

:READ:<meas>[n]?

Common Measurement Functions 2

The results available for various values of n are shown below:

Condition	N	Results Returned
Mode = VSA LTE IDEN	Not specified or n=1	Reserved for selected results of VSA measurements. If not used for a particular measurement, no result is returned and error -114 Header suffix out of range is generated
Mode = VSA LTE IDEN	2 – 50	Reserved for selected results of VSA measurements. If not used for a particular measurement, no result is returned and error -114 Header suffix out of range is generated

<p>Mode = VSA LTE IDEN, ACP on trace 1</p>	<p>51</p>	<p>ACP Summary for trace 1</p> <p>Returns 28 comma-separated scalar results, corresponding to the swept ACP results where possible; n/a elsewhere:</p> <p>Returns 28 comma-separated scalar results, in the following order.</p> <ol style="list-style-type: none"> 1. 0.0 2. Total carrier power (dBm) (same as item 4, because only 1 carrier supported) 3. 0.0 4. Reference carrier power (dBm) 5. Lower offset A - relative power (dB) 6. Lower offset A - absolute power (dBm) 7. Upper offset A - relative power (dB) 8. Upper offset A - absolute power (dBm) 9. Lower offset B - relative power (dB) 10. Lower offset B - absolute power (dBm) 11. Upper offset B - relative power (dB) 12. Upper offset B - absolute power (dBm) ... 21. Lower offset E - relative power (dB) 22. Lower offset E - absolute power (dBm) 23. Upper offset E - relative power (dB) 24. Upper offset E - absolute power (dBm) 25. n/a 26. n/a 27. n/a 28. n/a 29. Overall ACP test result summary (0 indicates at least 1 failure, 1 indicates all passed) <p>If any result is not available, NaN (9.91 E 37) is returned. This can happen if ACP is turned off (all results unavailable), or when an offset is entirely off-screen. In the case where it is partially off-screen, the measured result is returned, even though its validity is questionable.</p>
<p>Mode = VSA LTE IDEN, ACP on trace 2</p>	<p>52</p>	<p>ACP Summary for trace 2</p> <p>see list for trace 1 summary</p>
<p>Mode = VSA LTE IDEN, ACP on trace 3</p>	<p>53</p>	<p>ACP Summary for trace 3</p> <p>see list for trace 1 summary</p>

Common Measurement Functions 2

Mode = VSA LTE IDEN, ACP on trace 4	54	ACP Summary for trace 4 see list for trace 1 summary
Mode = VSA LTE IDEN, ACP on trace 5	55	ACP Summary for trace 5 see list for trace 1 summary
Mode = VSA LTE IDEN, ACP on trace 6	56	ACP Summary for trace 6 see list for trace 1 summary
	57–60	no result returned; error –114, Header suffix out of range generated
Mode = VSA LTE IDEN, OBW on trace 1	61	OBW Summary for trace 1 Returns 9 comma-separated scalar results, corresponding exactly to the items in the OBW Summary trace: 1. OBW (Hz) 2. Pwr (dBm) 3. Total Pwr (dBm) 4. Pwr Ratio (no unit, E.g. 0.99) 5. OBW upper freq (Hz) 6. OBW lower freq (Hz) 7. Centroid freq (Hz) 8. Offset freq (Hz) 9. OBW Test Result (0 for fail, 1 for pass) If the results are not available, NaN (9.91 E 37) is returned.
Mode = VSA LTE IDEN, OBW on trace 2	62	OBW Summary for trace 2 see list for trace 1 summary
Mode = VSA LTE IDEN, OBW on trace 3	63	OBW Summary for trace 3 see list for trace 1 summary
Mode = VSA LTE IDEN, OBW on trace 4	64	OBW Summary for trace 4 see list for trace 1 summary
Mode = VSA LTE IDEN, OBW on trace 5	65	OBW Summary for trace 5 see list for trace 1 summary

Mode = VSA LTE IDEN, OBW on trace 6	66	OBW Summary for trace 6 see list for trace 1 summary
--	----	---

Key Path	Remote Command Only
Mode	LTE, LTETDD, IDEN, VSA

:CALCulate:DATA

Once measurement data result is assigned to a trace, the data can be retrieved by using one of the following commands (where <n> is the trace number and <meas> is the current VSA based measurement).

:CALC:<meas>:DATA<n>?

:CALC:<meas>:DATA<n>:RAW?

The first form of the command retrieves the data as formatted on the display. For example, if (in a vector measurement) you have the Spectrum result in LogMag format on trace 1, then

:CALC:VECT:DATA1?

will return an array of spectrum amplitude (Y data) in units of dBm, and

:CALC:VECT:DATA1:RAW?

will return the Y data in its underlying units of Volts (peak) squared.

(To get data from displayed tables, see CALCulate:DATA:TABLE commands below.)

The CALC:<meas>:DATA commands get data from traces. There are many results available from a VSA based measurement, and only 4 traces in which to view them. View Preset commands are one way of displaying frequently-used results in standard trace locations. Or you may assign any measurement result to any trace using the softkeys under Trace/Detector, Data. The SCPI command for doing this is:

:DISP:<meas>:TRAC<n>:FEED "<data_name>"

For example, if (in a vector measurement) you wish to view the CCDF result in trace 4, you send:

:DISP:VECT:TRAC4:FEED "CCDF1"

(If the measurement has not run yet, use INIT:IMM to run it.) Then the CCDF data may be retrieved using

CALC:VECT:DATA4?

or

CALC:VECT:DATA4:RAW?

See the Data command (under Trace/Detector) and the View Preset commands (under View/Display) in this document as well as the PDs for each VSA based measurement for more details on assigning data to traces.

Key Path	SCPI only
----------	------------------

Common Measurement Functions 2

Mode	VSA, LTE, LTETDD, IDEN
Measurement	<meas>:=VECTor ADEMod DDEMod W11A W11B EVM IPOWer IDEMod MOTotalk
Remote Command	:CALCulate:<meas>:DATA[1] 2 3 4? [Y X XY[,OFF ON 0 1]]
Example	CALC:VECT:DATA1? CALC:VECT:DATA1? Y,ON CALC:VECT:DATA1? X CALC:VECT:DATA1? XY
Notes	<p>Query only. This retrieves the data in the designated trace as displayed.</p> <p>E.g., if Trace 1 is assigned Spectrum data and formatted as LogMag, then :CALC:VECT:DATA1? will return the Y data in dBm. If the X axis is scaled to show only a portion of the trace data, only the data shown will be returned.</p> <p>The numeric format of the returned data is controlled by FORMat[:TRACe][:DATA] command</p> <p>The optional parameters control what data is returned.</p> <p>:CALC:VECT:DATA1? Y is the same as :CALC:VECT:DATA1? with no parameter. It returns an array of Y values.</p> <p>:CALC:VECT:DATA1? X returns an array of X values that correspond to the Y values above.</p> <p>:CALC:VECT:DATA1? XY returns interleaved X and Y data. I.e.: <x1><y1><x2><y2>...</p> <p>Normally, this command only returns the data between the current X scale limits. If the optional ",OFF" or ",0" switch is included at the end of the command, then all data is returned (regardless of X scaling or the state of All Frequency Points).</p> <p>Note: the X and Y parameters in this command refer to the display's horizontal and vertical axes. Normally the X axis is the independent variable, but if the display format is Constellation or IQ, then</p> <p>CALC:<meas>:DATA<n>? [Y] returns the imaginary part of the data, and CALC:<meas>:DATA<n>? X returns the real part of the data. If you want the values of the independent variable, change to a non-vector format (such as Log Mag) and use CALC:<meas>:DATA<n>? X</p>
Initial S/W Revision	Prior to A.02.00
Modified at S/W Revision	A.02.00

:CALCulate:DATA:RAW

Retrieves trace data in its underlying units, before the formatting calculation that converts it to displayed units. Underlying units are typically Volts peak (for signal results) or Volts peak squared (for power results). All data points are returned, whether or not they are displayed.

Key Path	SCPI only
----------	------------------

Mode	VSA, LTE, LTETDD, IDEN
Measurement	<meas>:=VECTor ADEMod DDEMod W11A W11B EVM IPOWER IDEMod MOTotalk
Remote Command	:CALCulate:<meas>:DATA[1] 2 3 4:RAW?
Example	CALC:VECT:DATA1:RAW?
Notes	Query only. This retrieves the unformatted Y data in the designated trace. If Y data is complex, it is returned as <y_real1><y_imag1><y_real2><y_imag2> etc.
Initial S/W Revision	Prior to A.02.00
Modified at S/W Revision	A.02.00

:CALCulate:DATA:RAW:COMPLex

This command is used to determine if the data retrieved by CALC:<meas>:DATA:RAW<n>? is complex.

Key Path	SCPI only
Mode	VSA, LTE, LTETDD, IDEN
Measurement	<meas>:=VECTor ADEMod DDEMod W11A W11B EVM IPOWER IDEMod MOTotalk
Remote Command	:CALCulate:<meas>:DATA[1] 2 3 4:RAW:COMPLex?
Example	CALC:VECT:DATA1:RAW:COMP?
Notes	Query only. Returns 1 if the trace data is complex, 0 if it is real.
Initial S/W Revision	Prior to A.02.00
Modified at S/W Revision	A.02.00

:CALCulate:DATA:POINts commands

This query returns the number of points that will be returned by

CALCulate:<meas>:DATA<n>?

X axis scaling and whether All Frequency Points is on or off can affect this number.

NOTE For the CALCulate:<meas>:DATA<n>? XY command there are 2 numbers returned per data point.

Key Path	SCPI only
Mode	VSA, LTE, LTETDD, IDEN

Common Measurement Functions 2

Measurement	<meas>:=VECTor ADEMod DDEMod W11A W11B EVM IPOWER IDEMod MOTotalk
Remote Command	:CALCulate:<meas>:DATA[1] 2 3 4 :POINTS? [OFF ON 0 1]
Example	CALC:VECT:DATA1:POINTS?
Notes	<p>Query only.</p> <p>Use the optional "OFF 0" parameter to determine the number of points that will be returned by the optional command form:</p> <p>:CALCulate:<meas>:DATA<n>? Y X XY,OFF 0</p> <p>Note that this is points, not array size. If the XY parameter is included, there are 2 numbers returned per point.</p> <p>(ON or 0, which means use the X-scaled version, is the default and the result is the same as if the parameter is omitted).</p>
Initial S/W Revision	Prior to A.02.00
Modified at S/W Revision	A.02.00

This query returns the number of points that will be returned by

CALCulate:<meas>:DATA:RAW<n>?

NOTE For complex trace data, there are 2 numbers returned per data point.

Key Path	SCPI only
Mode	VSA, LTE, LTETDD, IDEN
Measurement	<meas>:=VECTor ADEMod DDEMod W11A W11B EVM IPOWER IDEMod MOTotalk
Remote Command	:CALCulate:<meas>:DATA[1] 2 3 4 :RAW:POINTS?
Example	CALC:VECT:DATA1:RAW:POINTS?
Notes	Query only.
Initial S/W Revision	Prior to A.02.00
Modified at S/W Revision	A.02.00

:CALCulate:DATA:TABL commands

Some traces have tabular data is associated with them. In fact, there may be only a table and no trace data. Each entry in the table consists of a name, a measured value, and units. The units are sometimes not shown. You can programmatically retrieve arrays of all the names, all the values, and all the units of a table. These arrays are all ordered so that corresponding indices have associated values, e.g., the 4th name in the names array corresponds to the 4th value in the results array. (Note that the array order may not be the same as the displayed order.) You can also get a particular result from the table by name. Here

is a summary of the remote table data commands.

Command	Returns	Example
CALCulate:<meas>:DATA<n>:TABLE?	All table data results (as an array)	CALC:DDEM:DATA4:TABL?
CALCulate:<meas>:DATA<n>:TABLE? "<name>"	The table data result referred to by name	CALC:DDEM:DATA4:TABL? "EvmPeak"
CALCulate:<meas>:DATA<n>:TABLE:NAMes?	Comma-separated list of all table data names	CALC:DDEM:DATA4:TABL:NAM?
CALCulate:<meas>:DATA<n>:TABLE:UNIT?	Comma-separated list of all table data units	CALC:DDEM:DATA4:TABL:UNIT?

For example, if within the Vector Analysis measurement, you have an OBW Summary Table displayed in trace 2, CALC:DDEM:DATA2:TABL:NAM? would return the table names as follows:

"Obw,Pwr,TotalPwr,PwrRatio,ObwUpper,ObwLower,Centroid,Offset"

and CALC:DDEM:DATA2:TABL:UNIT? would return the units. (A null string means the result is unitless.)

"Hz,Vrms^2,Vrms^2,,Hz,HZ,HZ,HZ"

You can then get all the table results by sending

CALC:DDEM:DATA2:TABL?

Result number 1 is Obw and has units of Hz, result number 2 is Pwr with units of Vrms^2, and so on.

You can also get individual table entries by asking for them by name. Any name returned from the CALC:DDEM:DATA2:TABL:NAM? query may be used. For example, to get TotalPwr you can send the following query:

CALC:DDEM:DATA2:TABL? "TotalPwr"

Query Table Data as Number

The following query gets data from a table shown in the designated trace. Tables shown on the display typically have the name of a parameter followed by its measured value

Key Path	SCPI only
Mode	VSA, LTE, LTETDD, IDEN
Measurement	<meas>:=VECTor ADEMod DDEMod W11A W11B EVM IPOWER IDEMod MOTotalk
Remote Command	:CALCulate:<meas>:DATA[1] 2 3 4 :TABLE[:NUMBER]? [<string>]

Common Measurement Functions 2

Example	CALC:DDEM:DATA2:TABL? "Obw"
Notes	Query only. If sent without a string specifier, this returns the entire table for the designated trace. If sent with a string specifier, returns a specific table entry in the designated trace. The string specifier must be delimited by single or double quotes. A list of valid strings can be obtained using CALC:<meas>:DATA:TABL:NAM? If an invalid string is sent, an error is generated. The returned results are in numeric format, under control of the FORMat[:TRACe][:DATA] command. For table data that is non-numeric, NaN is returned. To get the value of these data, use the CALC:<meas>:DATA2:TABL:STR? command
Initial S/W Revision	Prior to A.02.00
Modified at S/W Revision	A.02.00

Query Table Data as String

Some tables have string data. The above Trace Table Data query cannot return it, and sends NaN in its place. Here is a form of Trace Table Data query that can return string data from tables.

Key Path	SCPI only
Mode	VSA, LTE, LTETDD, IDEN
Measurement	<meas>:=VECTor ADEMod DDEMod W11A W11B EVM IPOWer IDEMod MOTotalk
Remote Command	:CALCulate:<meas>:DATA[1] 2 3 4 :TABLe:STRing? [<string>]
Example	CALC:DDEM:DATA2:TABL:STR? "Obw"
Notes	Query only. If sent without a string specifier, this returns the entire table for the designated trace, in comma-separated format. If sent with a string specifier, returns a specific table entry in the designated trace. The string specifier must be delimited by single or double quotes. A list of valid strings can be obtained using CALC:<meas>:DATA:TABL:NAM? If an invalid string is sent, an error is generated.
Initial S/W Revision	Prior to A.02.00
Modified at S/W Revision	A.02.00

Query Table Names

The following query returns a comma-separated list of names of the table data entries for the designated trace. Each of names may be used (surrounded by quotes or double quotes) as a parameter in the Trace Table Data commands. The names appear in the same order as the corresponding data values returned by the CALC:<meas>:DATA<n>:TABL[:NUMB|STR]? query.

Key Path	SCPI only
Mode	VSA, LTE, LTETDD, IDEN

Measurement	<meas>:=VECTor ADEMod DDEMod W11A W11B EVM IPOWer IDEMod MOTotalk
Remote Command	:CALCulate:<meas>:DATA[1] 2 3 4:TABLE:NAMES?
Example	CALC:VECT:DATA1:TABLE:NAM?
Notes	Query only. This retrieves the names of the table entries for the designated trace. Each of these names may be used in the CALC:<meas>:DATA:TABLE? '<name>' command to access a single table entry.
Initial S/W Revision	Prior to A.02.00
Modified at S/W Revision	A.02.00

Query Table Units

The following query returns a comma-separated list of all the units for the table data entries for the designated trace. If a data result is unitless, an empty string appears in the list for that result. The units appear in the same order as the corresponding data values returned by the CALC:<meas>:DATA<n>:TABLE[:NUMB|STR]? query.

Key Path	SCPI only
Mode	VSA, LTE, LTETDD, IDEN
Measurement	<meas>:=VECTor ADEMod DDEMod W11A W11B EVM IPOWer IDEMod MOTotalk
Remote Command	:CALCulate:<meas>:DATA[1] 2 3 4:TABLE:UNIT?
Example	CALC:VECT:DATA1:TABLE:UNIT?
Notes	Query only. This retrieves a list of units for table entries for the designated trace. The units are given in the order that the entries are sent from the :CALC:<meas>:DATA:TABLE? command.
Initial S/W Revision	Prior to A.02.00
Modified at S/W Revision	A.02.00

The following table data is available in all measurements when the ACP function is turned on and the associated summary table is shown in a trace:

Result name	Displayed Unit	Remote Name	Remote Unit
Reference Bandwidth	Hz	RefBw	Hz
Reference Alpha		RefAlpha	
Reference Power	dBm	RefPwr	Vrms^2
Offset	Hz	Offset1, Offset2, Offset3, Offset4, Offset5	Hz

Common Measurement Functions 2

Result name	Displayed Unit	Remote Name	Remote Unit
BW	Hz	Bw1, Bw2, Bw3, Bw4, Bw5	Hz
Alpha		Alpha1, Alpha2, Alpha3, Alpha4, Alpha5	
Lower Pwr	dBm	LowPwr1, LowPwr2, LowPwr3, LowPwr4, LowPwr5	Vrms^2
Lower ACPR	dB	LowRatio1, LowRatio2, LowRatio3, LowRatio4, LowRatio5	
Upper Pwr	dBm	HiPwr1, HiPwr2, HiPwr3, HiPwr4, HiPwr5	Vrms^2
Upper ACPR	dB	HiRatio1, HiRatio2, HiRatio3, HiRatio4, HiRatio5	
Max ACPR	dB	MaxRatio1, MaxRatio2, MaxRatio3, MaxRatio4, MaxRatio5	

The following table data is available in all measurements when the OBW function is turned on and the associated summary table is shown in a trace:

Result name	Displayed Unit	Remote Name	Remote Unit
Occupied Bandwidth	Hz	Obw	Hz
Power	dBm	Pwr	Vrms^2
Total Power	dBm	TotalPwr	Vrms^2
Power Ratio	%	PwrRatio	
Upper Freq	Hz	ObwUpper	Hz
Lower Freq	Hz	ObwLower	Hz
Centroid Freq	Hz	Centroid	Hz
Offset Freq	Hz	Offset	Hz

:CALCulate:DATA:HEADer commands

Trace data also has meta-data associated with it, called headers, which is visible if you export trace data in text format. The headers have a name and a value that can be obtained from any trace by using the CALCulate:<meas>:DATA:HEADer commands described in this section.

The following Remote Commands are described in this section:

[“Query Header Names” on page 1801](#)

“Query Header Type” on page 1801

“Query Header as String” on page 1802

“Query Numeric Header” on page 1802

“:CALC:CLIMits:FAIL?” on page 1803

Query Header Names

The following query returns a comma-separated list of all the header names associated with the designated trace. Each of the names may be used (surrounded by quotes or double quotes) as a parameter in the other CALC:<meas>:DATA<n>:HEAD queries.

Key Path	SCPI only
Mode	VSA, LTE, LTETDD, IDEN
Measurement	<meas>:=VECTor ADEMod DDEMod W11A W11B EVM IPOWer IDEMod MOTotalk
Remote Command	:CALCulate:<meas>:DATA[1] 2 3 4:HEADer:NAMes?
Example	CALC:VECT:DATA1:HEAD:NAM?
Notes	Query only. Returns a comma-separated list of header names.
Initial S/W Revision	Prior to A.02.00
Modified at S/W Revision	A.02.00

Query Header Type

This query returns whether the designated header on the designated trace may be queried as a number, or by a string only.

Key Path	SCPI only
Mode	VSA, LTE, LTETDD, IDEN
Measurement	<meas>:=VECTor ADEMod DDEMod W11A W11B EVM IPOWer IDEMod MOTotalk
Remote Command	:CALCulate:<meas>:DATA[1] 2 3 4:HEADer:TYPE? <string>
Example	CALC:VECT:DATA1:HEAD:TYPE? 'XDelta'
Notes	Query only. This retrieves the type of the named header for the designated trace. The name (delimited by single or double quotes) is one of the names returned by the CALC:<meas>:DATA:HEAD:NAMes? If a valid header name is passed in, the return value from this query is either STR or NUMB. NONE is returned if there is no such header.
Initial S/W Revision	Prior to A.02.00
Modified at S/W Revision	A.02.00

Common Measurement Functions 2

Query Header as String

This query gets a header by name from the designated trace and returns its value as a string.

Key Path	SCPI only
Mode	VSA, LTE, LTETDD, IDEN
Measurement	<meas>:=VECTor ADEMod DDEMod W11A W11B EVM IPOWer IDEMod MOTotalk
Remote Command	:CALCulate:<meas>:DATA[1] 2 3 4:HEADer:STRing? <string>
Example	CALC:VECT:DATA1:HEAD:STR? 'WindowType'
Notes	Query only. This retrieves the named header for the designated trace. The name (delimited by single or double quotes) is one of the names returned by the CALC:<meas>:DATA:HEAD:NAMes? The return value is a string. If the requested header value is a numeric, or if there is no such header, an empty string is returned..
Initial S/W Revision	Prior to A.02.00
Modified at S/W Revision	A.02.00

Query Numeric Header

This query gets a numeric header by name from the designated trace and returns its value in a format determined by the last FORM command.

Key Path	SCPI only
Mode	VSA, LTE, LTETDD, IDEN
Measurement	<meas>:=VECTor ADEMod DDEMod W11A W11B EVM IPOWer IDEMod MOTotalk
Remote Command	:CALCulate:<meas>:DATA[1] 2 3 4:HEADer[:NUMBER]? <string>
Example	CALC:VECT:DATA1:HEAD? 'XDelta'
Notes	Query only. This retrieves the named header for the designated trace. This form of the HEAD? query is for headers whose type is NUMB (as determined by :CALC:<meas>:DATA:HEAD:TYPE?) The name parameter (delimited by single or double quotes) is one of the names returned by the CALC:<meas>:DATA:HEAD:NAMes? The format of the return data is determined by the FORMat[:TRACe][[:DATA] command. If used to query a header whose type is STR, or there is no such header, NaN (9.91e37) is returned
Initial S/W Revision	Prior to A.02.00
Modified at S/W Revision	A.02.00

:CALC:CLIMits:FAIL?

If one or more ACP or OBW limit tests are active, then the CALC:CLIMits:FAIL? command will return the aggregate pass or fail status.

IQ Data Transfers

Fast capture/transfer of a large amount of IQ data is supported over SCPI. To do this, first set up the desired measurement range, center frequency, span, triggering, etc. Use a time length that is convenient for setting up the measurement. The time length for the captured data will be set indirectly as shown below.

To perform the capture, a typical SCPI sequence is as follows:

```
FCAP:LENG <num_samples>
```

This command sets the length for the next capture in samples. The sample rate is proportional to the current span, and can be determined by a SCPI query, e.g., in the Vector measurement the query:

```
VECT:SWE:ISR?
```

returns the input sample rate. Multiply the time length desired for the captured data by this sample rate to get the number of samples to needed.

```
INIT:FCAP
```

will pause the current measurement and start capturing IQ data using the current setup and trigger conditions. (The instrument front panel display will not change nor show the captured data.)

To read the captured data via SCPI in blocks, set the read block size using the command:

```
FCAP:BLOC <num_points_per_read_block>
```

The maximum read block size is typically less than the total fast capture buffer size, and can be determined by the query "FCAP:BLOC? MAX". Now you can repeatedly use the following query to read out successive blocks of data:

```
FETC:FCAP?
```

The returned data is formatted according to the most recent :FORMat[:DATA] and :FORMat:BORDER commands. A read pointer that indicates the next sample to be transferred is advanced automatically following each FETC:FCAP? query. This pointer position can be read or manually set via the SCPI commands

```
FCAP:POIN?
```

```
FCAP:POIN <read_pointer_position>
```

The fast capture data may be read as long as you use only the commands to set read block size and pointer position, or queries that return the state of the current measurement. The capture data is cleared by any command that changes the measurement state or initiates a new measurement, or via SCPI device clear or :ABORT commands.

Fast capture data word size may be set to either 32 bit or 64 bit via the FCAP:WLEN command. This allows you to trade off precision for total capture length.

Note: when the word size is 32 bit, points can only be retrieved on even sample number boundaries, i.e., the pointer and block length should be even numbers. Therefore, when the word size is set to auto, it is

Common Measurement Functions 2

recommended that the pointer and block size be only set to even numbers.

Fast Capture Length

Sets the length of the SCPI Fast Capture in samples (points). This is constrained to be an even number.

Query returns the most recent length setting.

Mode	VSA
Remote Command	[:SENSe]:FCAPture:LENGth <integer> [:SENSe]:FCAPture:LENGth?
Example	FCAP:LENG 1000 FCAP:LENG?
Notes	This is affected by the IF path currently used, which may in turn be affected by span. It is also affected by the internal Fast Capture Word Length. The current maximum fast capture length may be found by using the query: FCAP:LENG? MAX Changing the Capture Length after initiating a fast capture clears the capture memory in preparation for a new fast capture of a different length. No Front panel access; SCPI only
Preset	1048576 Samples
Min	2
Max	536 870 908 Samples for internal 40 MHz and 140 MHz options with FCAP:WLEN BIT32
Initial S/W Revision	A.04.00

Fast Capture Word Length

Allows choice of internal fast capture word length. Shorter word length allows twice the time length to be captured, at the cost of quantization noise. Note that this does not affect the format of data returned by FETCh:FCAPture, only the internal representation.

Mode	VSA
Remote Command	[:SENSe]:FCAPture:WLENGth AUTO BIT32 BIT64 [:SENSe]:FCAPture:WLENGth?
Example	FCAP:WLEN AUTO FCAP:WLEN?
Notes	No Front panel access; SCPI only.
Preset	AUTO

Initial S/W Revision	A.04.00
----------------------	---------

Initiate Fast Capture

Waits for the sweep to trigger and then captures the fast capture data. Sweep is then set to pause. The amount of data captured is controlled by the Fast Capture Length command (FCAP:LENG).

Mode	VSA
Remote Command	:INITiate:FCAPture
Example	INIT:FCAP
Notes	Returns when the capture is complete.
Notes	No Front panel access; SCPI only This command resets the Fast Capture Pointer to 0
Initial S/W Revision	A.04.00

Fast Capture Block

Sets the block size for the Fast Capture transfer in samples (points). This is the number of points that will be returned from the Capture buffer by the FETC:FCAP? command. This is constrained to be an even number.

Query returns most recent block size setting.

Mode	VSA
Remote Command	[:SENSe]:FCAPture:BLOCK <integer> [:SENSe]:FCAPture:BLOCK?
Example	FCAP:BLOC 100 FCAP:BLOC?
Notes	No Front panel access. SCPI only.
Preset	1024 Samples
Min	0
Max	131072 or Fast Capture Length, whichever is smaller
Initial S/W Revision	A.04.00

Fast Capture Pointer

Sets the pointer position for the Fast Capture transfer in samples (points). The pointer is incremented by the block size each time the fetch is performed. Preset value (0) is the first sample in the record. Thus repetitive fetches will result in contiguous data without needing to increment the pointer over SCPI. This

Common Measurement Functions 2

is constrained to be an even number. Query returns most recent pointer setting.

Mode	VSA
Remote Command	[:SENSe]:FCAPture:POINter <integer> [:SENSe]:FCAPture:POINter?
Example	FCAP:POIN 100 FCAP:POIN?
Notes	INIT:FCAP or FCAP:ABOR resets the pointer to 0. No front panel access; SCPI only.
Preset	0 Samples
Min	0
Max	Must be less than the Fast Capture length
Initial S/W Revision	A.04.00

Fetch Fast Capture

Transfers the block of data starting at the pointer. The number of samples transferred is set with the block size. The pointer is incremented by the block size after the fetch.

Mode	VSA
Remote Command	:FETCh:FCAPture?
Example	FETC:FCAP?
Notes	The returned data is formatted according to the most recent :FORMat[:DATA] and :FORMat:BORDer commands. If the read pointer position plus read block size exceeds the Fast Capture Length, only the data between the pointer and the end of the fast capture buffer are returned, and error -200 is reported.. If Fetch is attempted before an INIT:FCAP (or if the captured data is cleared by some other operation ,e.g. REC; error -230 is reported and no data is returned. No front panel access; SCPI only.
Initial S/W Revision	A.04.00

Input Sample Rate Query

This SCPI only query returns the complex sample rate in Hz for the current VXA measurement setup conditions. The sample rate can be used to convert between time and number of sample points when using the Fast Capture feature.

Sample rate depends on the settings for `FREQ:SPAN` and `IFPath`. You need to set these before making this query. Though the measurement name is specified in the query, you can only query the currently

configured measurement. That is, if you have sent CONF:VECT, the query ADEM:SWE:ISR? will generate an error.

Mode	VSA
Measurement	<meas>:=VECTor ADEMod DDEMod W11A W11B
Remote Command	[:SENSe] : <meas> : SWEp : ISRate?
Example	VECT:SWE:ISR?
Notes	Query returns the complex sample rate in Hz for the current VXA Vector measurement setup conditions. If the measurement in the query is not the active measurement, error -230 is reported and no data is returned. This query is SCPI only, no Front Panel softkey.
Preset	Depends on the licensed IF path
Initial S/W Revision	A.04.00

Parameter Update Enable

This command refers only to measurements that use the VSA measurement engine. These are all the measurements in the Vector Signal Analyzer (VXA) Application, and the EVM measurement in the LTE Applications.

When a measurement parameter is changed, the new value is used to update any dependent parameters and measurement results. This update process is normally done after every parameter change. This allows visual feedback during interactive GUI operation. However, with SCPI controlled measurements, typically a lot of parameter changes are done at once with the measurement stopped and then the measurement is run once and data retrieved. Here, is not necessary, and the accumulated update time for each parameter change can become significant. The Parameter Update Enable command allows you to postpone update while sending setup commands, and then allow one update to occur just before the measurement.

For example, if you are programmatically setting up a complex LTE measurement, you could save some setup time by first sending EVM:PUPD:ENAB OFF, then sending the whole group of measurement setup commands. When you are done with the setup, send EVM:PUPD:ENAB:ON. This causes the measurement state to be updated with all dependencies resolved. After this, you can read back the parameters' actual values. As a convenience, starting or continuing a measurement (INITiate:REStart, INITiate:IMMEDIATE, INITiate:<meas> or INITiate:RESume) will automatically set <meas>:PUPD:ENAB to ON. So will CONFigure:<meas>, or any of the reset and recall state commands.

This command should be used with caution.

It is only valid to turn <meas>:PUPD:ENAB OFF when <meas> is the currently active measurement and the measurement is paused (i.e., INIT:CONT is OFF).

If you try to set and then read back a parameter value while Parameter Update Enable is off, you are not guaranteed to get back true value that will be used in the measurement, because no parameter limiting is being done nor are any dependencies between parameters being resolved.

Common Measurement Functions 2

If you try to set coupled parameters independently when Parameter Update Enable is off, then when it is turned on, at most one of the parameter settings will remain the same and the others will change due to dependency resolution.

Key Path	SCPI only
Mode	VSA, LTE, LTETDD, IDEN
Measurement	<meas>:=VECTor ADEMod DDEMod W11A W11B EVM IPOWer IDEMod MOTotalk
Remote Command	[:SENSe] : <meas> : PUPDate : ENABle OFF ON 0 1 [:SENSe] : <meas> : PUPDate : ENABle?
Example	EVM:PUPD:ENAB OFF
Notes	Commands that cause a measurement to run, that switch measurements, or that preset or recall measurement state will set Parameter Update state to ON. These include INIT:IMM, INIT:REST, INIT:RES, INIT:<meas>, and CONF:<meas>.
Preset	1
State Saved	No
Initial S/W Revision	A.03.00